

Installation Instructions



for your new



Whirlpool

Electric Dryer

Before you begin ...

read the following instructions completely and carefully.
They will simplify the installation.

AFTER COMPLETING THE INSTALLATION, SAVE THESE INSTRUCTIONS FOR FUTURE USE.

IMPORTANT: OBSERVE ALL GOVERNING CODES AND ORDINANCES

Where to install the dryer –

Your dryer should, of course, be installed in a location that is convenient for you; however, there are other factors which should be considered before selecting the permanent location.

Codes Requirements – There are some codes which prohibit or restrict installation of clothes dryers in garages, closets, mobile homes and sleeping quarters. If in doubt about the location you have chosen, check with your local building inspector.

Utilities – Connections to proper electric supply should be available. See page 3.

Exhaust – A four (4) inch metal exhaust duct is recommended. Is there one available or can one be installed to meet requirements in pages 4, 5 and 6?

Physical Characteristics – The site must be large enough for the dryer and allow room to fully open the dryer door. The floor must be able to support the weight and the dryer must be protected from the weather. If the temperature where the dryer is to be installed is not above 45° F, the dryer may not shut off when automatic cycles are used.

CAUTION:

- It is the personal responsibility of the customer to ensure that gasoline, paint, thinners and other flammable materials are not used or stored near the dryer. Fumes from these materials could result in fire or explosion.
- **Never** install the dryer up against draperies or curtains and be sure to keep any and all items from falling or collecting behind the dryer.
- Replace all access or service panels before operating dryer.

ELECTRICAL REQUIREMENTS

1. A three-wire or four-wire single phase 120/240 volt 60 Hz AC only electrical supply (or three-wire or four-wire 120/208 volt if specified on nameplate) is required on a separate 30 ampere circuit, fused on both sides of the line (time-delay fuse or circuit breaker is recommended). Do **NOT** fuse neutral.

2. **THE DRYER MUST BE CONNECTED WITH COPPER WIRE ONLY.** Aluminum wire must not be used to avoid potentially unsatisfactory connections.

3. Local codes may permit the use of a flexible type 30 ampere UL listed power supply cord (pigtail) with no smaller than No. 10 copper wire to match three-wire receptacle of NEMA Type 10-30R shown in the following figure. A suitable strain relief must be provided at the point the power supply cord enters the appliance.

WARNING: Do not plug the power supply cord (pigtail) into a live wall receptacle before connecting the pigtail to the dryer terminal block.

4. The appliance may be connected directly to the fused disconnect (or circuit breaker) box through flexible armored or non-metallic sheathed copper cable. Allow two or three feet of slack in the line between the wall and the appliance so that it can be moved if servicing is ever necessary. A suitable strain relief must be provided at each end of the power supply cord (at the appliance and at the junction box). Wire sizes (**COPPER WIRE ONLY**) and connections must conform with the rating of the appliance (30 amperes). Do not use an extension cord.

IMPORTANT:

OBSERVE ALL GOVERNING CODES AND ORDINANCES

5. **CAUTION:** For mobile home installations, the appliance wiring must be revised. The appliance frame must not be connected to the neutral terminal, but must be connected to the ground wire (green) of the power supply cord.

If four-wire receptacle of NEMA Type 14-30R is used (see figure below), a matching UL listed power supply cord (pigtail) for mobile homes must be used. This cord contains four No. 10 copper conductors with spade or ring terminals on dryer end terminating in a NEMA type 14-30P plug on supply end. The fourth (grounding) conductor must be identified by a green cover and the neutral conductor by a white cover. Cord should be Type SRD or SRDT, with strain relief and be at least 4 feet long. The power supply cord and strain relief are not provided with the dryer.

3 WIRE RECEPTACLE

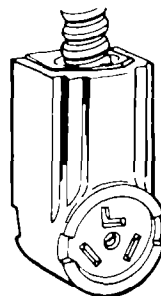

RECEPTACLE
(10-30R)

4 WIRE RECEPTACLE

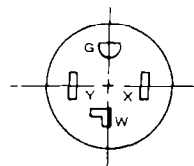

RECEPTACLE
(14-30R)

Typical 30 ampere receptacles for use where local codes permit use of flexible power supply cord (pigtail).

EXHAUST SYSTEM REQUIREMENTS

1. CAUTION: FOR YOUR PERSONAL SAFETY DO NOT EXHAUST DRYER INTO A CHIMNEY, FURNACE COLD AIR DUCT OR ANY OTHER COMMON DUCT, ATTIC OR CRAWL SPACE. ACCUMULATED LINT COULD BECOME A FIRE HAZARD OR MOISTURE COULD CAUSE DAMAGE.

DO NOT USE 3 INCH EXHAUST DUCT

- 2. You can get the parts you need for installation from your Whirlpool parts distributor or your local plumbing and heating store.
- 3. We strongly recommend exhausting the dryer to the outside to prevent large amounts of moisture and lint from being blown into the room.
- 4. If you cannot exhaust your dryer to the outside, use Exhaust Deflector Kit LCK4000 available from your Whirlpool dealer. See FIG. 1.

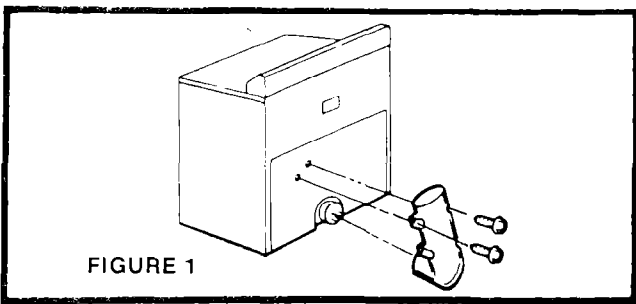
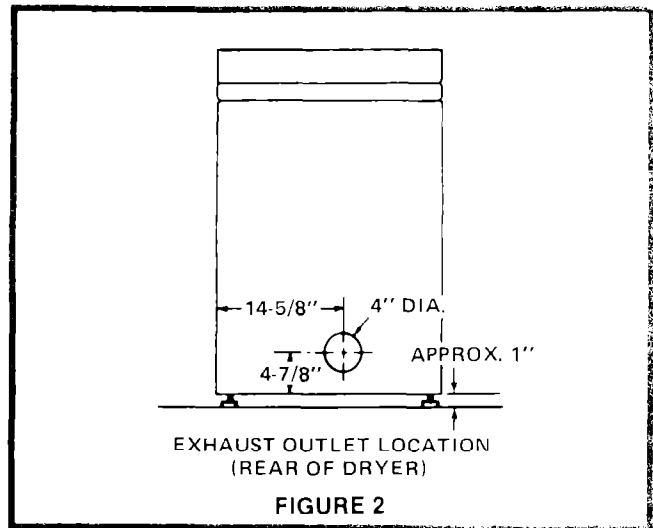

FIGURE 1

5. Exhaust outlet at rear of the dryer is located as shown in Figure 2. Detailed instructions on spacing from side and rear clearances can be found in the section "Instructions for Recessed or Closet Installations." Information on minimum spacing side to side and to the rear is also found on a label located on back panel.



6. We strongly recommend exhausting with 4 inch diameter rigid METAL duct. We strongly recommend METAL flexible duct if you use flexible duct. Flexible aluminum duct is available from your Whirlpool dealer or parts distributor. NEVER USE SMALLER THAN 4 INCH EXHAUST DUCT.

7. The exhaust may be routed up, down, left, right or straight through the wall.

8. The exhaust duct should terminate with an exhaust hood to prevent back drafts. The outlet of the hood must be at least 12 inches from the ground or any obstruction. A louvered exhaust hood, Part Number 279399 is available from your Whirlpool dealer or parts distributor. An exhaust hood with a 2½ inch outlet creates more back pressure, but may be used with shorter systems. Never use an exhaust hood with a magnetic latch.

9. The maximum length of the exhaust system depends upon the type of duct used, the number of elbows and the type of exhaust hood. The maximum length for both rigid and flexible duct is shown in the chart, FIG. 3.

NUMBER OF 90 TURNS	EXHAUST HOOD TYPE			
				
0	43 FT.	41 FT.	36 FT.	MAXIMUM LENGTH OF 4" DIA. RIGID METAL DUCT.
1	33 FT.	31 FT.	26 FT.	
2	23 FT.	21 FT.	16 FT.	
0	30 FT.	29 FT.	24 FT.	MAXIMUM LENGTH OF 4" DIA. FLEXIBLE METAL DUCT.
1	24 FT.	23 FT.	18 FT.	
2	16 FT.	15 FT.	10 FT.	

Figure 3

10. Use duct tape to seal all joints. Never use screws to assemble the ductwork, screws can catch lint.

11. Exhaust systems longer than specified will shorten the life of the dryer and result in reduction of performance such as longer drying time and increased use of energy. Lint may also accumulate creating a possible safety hazard. The exhaust system should be cleaned periodically, at least every two years.

12. We do NOT RECOMMEND non-metallic flexible duct. If you use non-metallic flexible duct you must connect a METAL elbow and at least 2 feet of METAL duct to the dryer outlet. The length of the non-metallic flexible duct should not exceed 7 feet, and it must be adequately supported to prevent sagging or kinking. See FIG. 6.

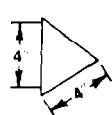
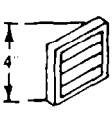
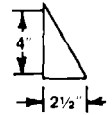
NEVER INSTALL ANY TYPE OF FLEXIBLE DUCT CONCEALED IN WALLS OR CEILING

13. There are exhaust kits available that allow the filtered exhaust air to be directed inside to conserve energy during winter months. These devices may be used with Whirlpool dryers providing their use does not violate national or local codes and providing the device does not restrict exhaust air flow. If you use one of these kits, be aware that excessive moisture in the home can cause many problems and that you may see an increase in the time required to dry a load. Also, if you use one of these kits, you must maintain it properly to avoid excessive lint build-up, which can affect the dryers's performance.

14. For mobile home installations the dryer must be exhausted to the outside. If the dryer is exhausted through the floor and the area under the mobile home is enclosed, the exhaust system must terminate outside the enclosure. Extension beyond the enclosure will prevent the accumulation of lint and moisture under the mobile home. See Figure 4.

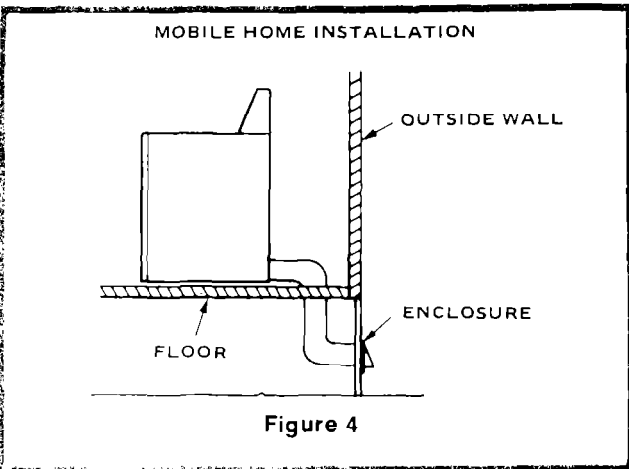

TYPICAL EXHAUST INSTALLATION

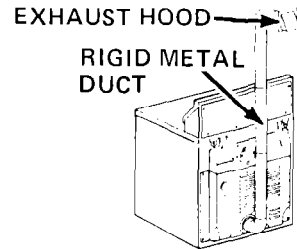

Figure 5

RECOMMENDED

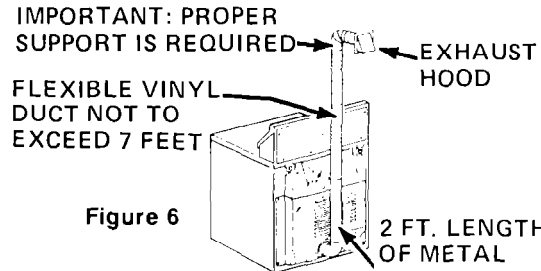

Figure 6

ALTERNATE

For your personal safety, a metal elbow and at least 2 feet of metal duct must be used at the outlet of the dryer. This reduces the possibility of lint blocking the exhaust system and minimizes the potential of a fire hazard. The 2 feet of metal duct also helps make any service that may be needed easier and prevents crushing the flexible duct when the dryer is moved to its final operating location.

INSTALLATION INSTRUCTIONS

DO NOT GRASP APPLIANCE BY THE CONSOLE

DO NOT MOVE APPLIANCE INTO ITS EXACT LOCATION UNTIL THE FOLLOWING STEPS HAVE BEEN PERFORMED

A. REMOVE LITERATURE AND MISCELLANEOUS PARTS

After removing the literature package and miscellaneous parts bag from the dryer drum, place the Operation Instructions and Dryer Guide in a convenient place as both pieces of literature should be read.

B. REMOVE TAPE FROM DRUM

On some models tape is used to secure the drum during shipping. Remove the tape that holds the drum to the cabinet. Move the drum by hand to make certain all tape has been removed.

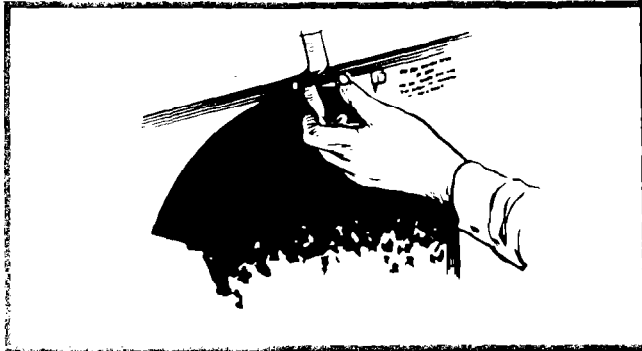

Next wipe the interior of the drum thoroughly with a damp cloth before using the dryer.

C. INSTALL DRYER LEVELING FEET

Block up the front of the dryer about four inches using a block of wood as shown in illustration "A". Install the leveling feet in the front corners of the dryer using a 1" wrench or socket to turn in the leveling feet. See illustration "B". All feet should extend approximately one inch. Remove the block and repeat the procedure at the rear of the dryer.

For mobile home installations all floor mounted dryers must be fastened to the floor during transit using Kit No. 346765. The dryer does not need to be fastened to the floor while the mobile home is not in transit.

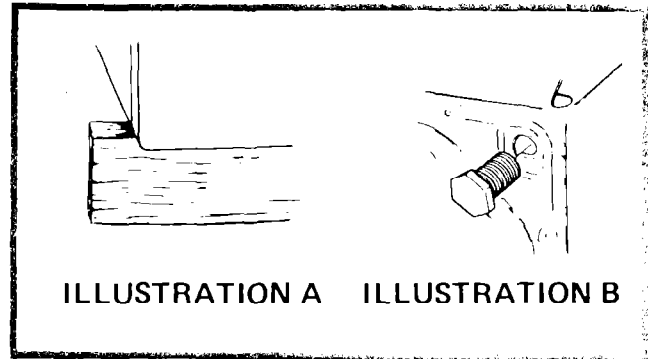

ILLUSTRATION A ILLUSTRATION B

D. ELECTRICAL CONNECTION

It is the personal responsibility of the customer to contact a qualified installer to assure that the electrical installation is adequate and is in conformance with the National Electrical Code and local codes and ordinances.

Electrical ground is required on this appliance. This appliance is manufactured with the neutral terminal connected to the frame.

A. If local codes permit connection of the frame grounding conductor to the neutral wire of the power supply cord:

- (1) Remove the terminal block cover by removing the screw shown in the illustration.
- (2) Connect the neutral wire of the power supply cord to the center silver colored terminal of the terminal block and connect the other wires to the outer terminals. See illustration labeled "Grounded Neutral." For connecting plain-end field wire, see figure labeled "Plain-end Field Wiring."

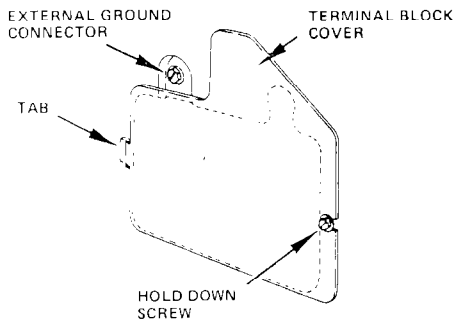

- (3) Replace the terminal block cover by first installing the tab of the cover into the slot of the dryer rear panel (see illustration on page 8). Secure the cover with the mounting screw.

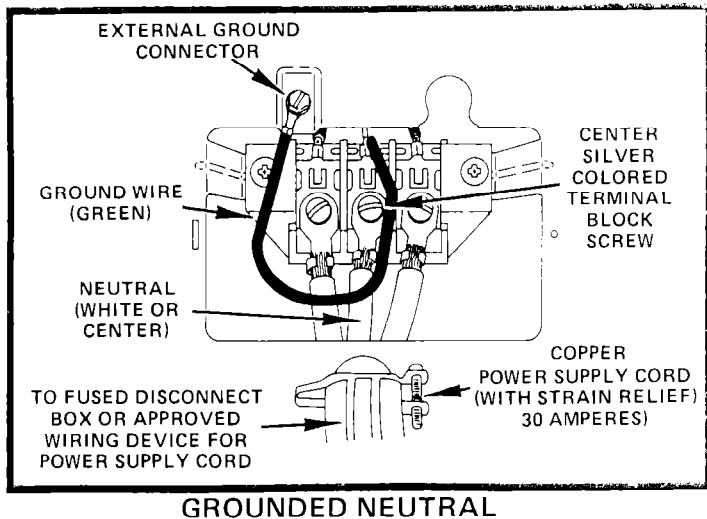

B. If local codes DO NOT permit frame grounding to the neutral wire of the power supply cord:

- (1) Remove terminal block cover.
- (2) Remove the ground wire (green) from the external ground connector and fasten under center silver colored terminal block screw.

- (3) Connect the neutral wire of the power supply cord to the center silver colored terminal of the terminal block and connect the other wires to the outer terminals. See illustration labeled "Ungrounded Neutral." For connecting plain-end field wire see illustration labeled "Plain-end Field Wiring."

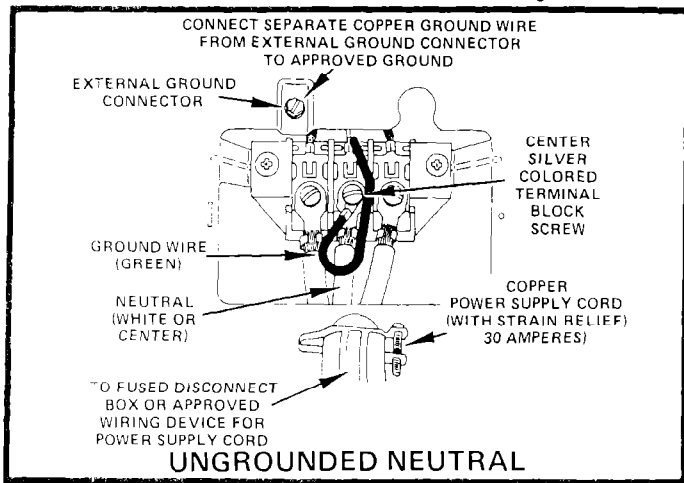

- (4) Connect a separate copper ground wire (No. 10 minimum) to a grounded cold water pipe* by means of a clamp and then to the frame of the appliance at the external ground connector. Use Part No. 685463 ground wire and clamp assembly. Do not ground to a gas supply pipe. Do not connect the power supply cord to electric power supply until appliance is permanently grounded. See following illustration.
- (5) Replace terminal block cover.

*Cold water pipe must have metal continuity to electrical ground and not be interrupted by plastic, rubber or other electrically insulating connectors (including water meter or pump) without adding a jumper wire at these connections.

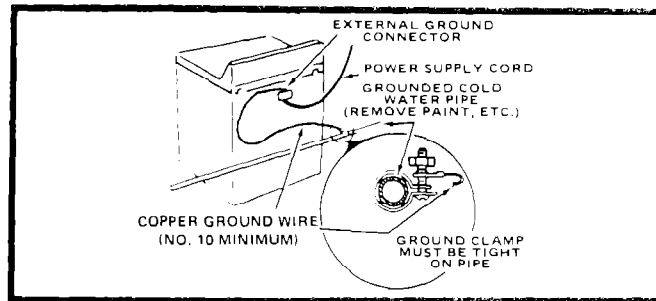

- C. If connecting to a four-wire electrical system (mobile home):
- (1) Remove the terminal block cover by removing the screw shown in the illustration on page 8.
 - (2) Remove ground wire (green) from the external ground connector and fasten under center silver colored terminal block screw.
 - (3) Connect the ground wire (green) of the power supply cord to the external ground connector.
 - (4) Connect the neutral wire (white) of the power supply cord to the center silver colored terminal of the terminal block and connect the other wires to the outer terminals. See illustration labeled "4-Wire Ungrounded Neutral." For connecting plain-end field wire, see illustration labeled "Plain-end Field Wiring."
 - (5) Replace the terminal block cover by first installing the tab of the cover into the slot of the dryer rear panel (see illustration on page 8). Secure the cover with the mounting screw.

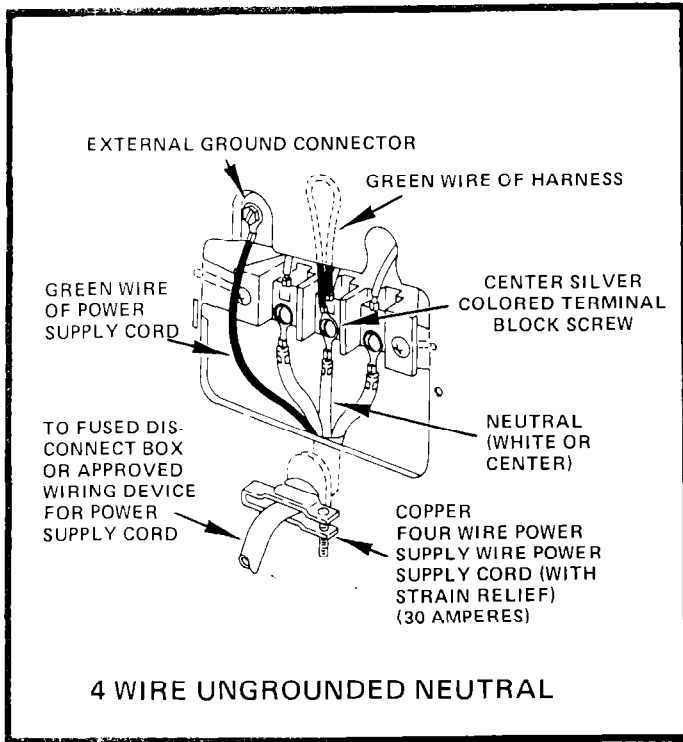

PLAIN-END FIELD WIRING

NOTE: The terminal connections at the dryer terminal block are suitable for connection of No. 10 copper wire only. Plain-end field wires must be fastened between the terminals of the terminal block and the nuts of the terminal block screws as shown in the illustration labeled "Plain-end Field Wiring."

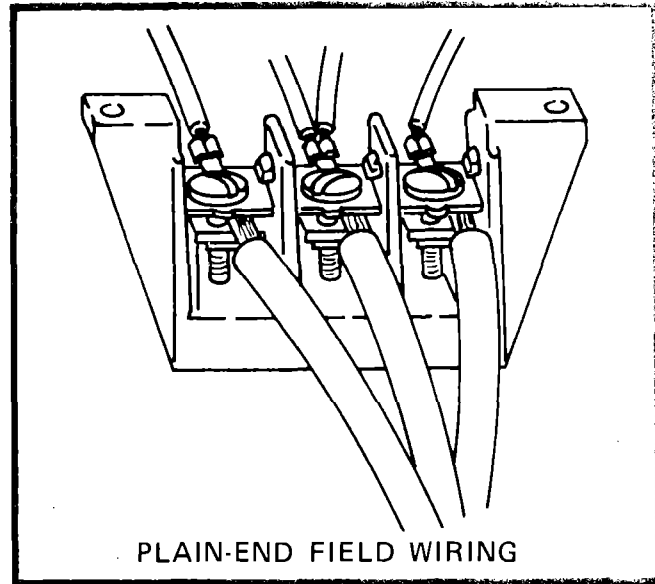

E. FINAL INSTALLATION CONNECTIONS

1. Move the dryer to its operating position and check the level of the machine using a small spirit level. The dryer can be leveled from side to side and front to rear by adjusting the four leveling legs.

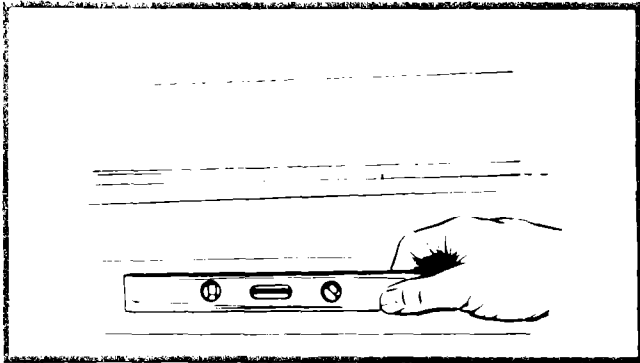

2. Make the electrical connection:
 - A. Plug the flexible connector (pigtail) into an approved receptacle (where local codes permit the use of a pigtail).
 - OR
 - B. Connect the flexible armored or non-metallic shielded cable directly to a fused disconnect box.
3. Connect the exhaust piping to exhaust outlet of dryer. Joints should be taped. Do not use screws to fasten sections of pipe together.
4. Refer to your Operating Instruction Book and Dryer Guide for information on how to operate your dryer.
5. Install literature rack to console rear panel (on models so equipped). Refer to instructions on Page 15.

INSTRUCTIONS FOR RECESSED OR CLOSET INSTALLATIONS

TO PREVENT LARGE AMOUNTS OF LINT AND MOISTURE FROM ACCUMULATING AND TO MAINTAIN DRYING EFFICIENCY, THIS MACHINE MUST BE EXHAUSTED OUTDOORS.

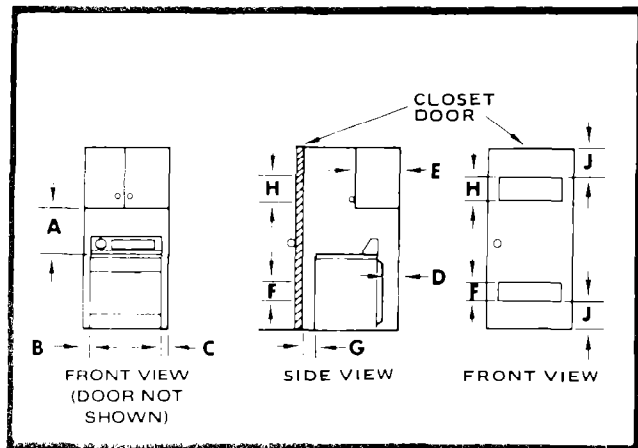

The following installation spacings and door air openings for the dryer are possible when installed and exhausted as noted. (Spacing as indicated is in inches and is minimum allowable. For ease of installation and service, additional spacing should be considered.)

RECESS INSTALLATION	A	B	C	*** D	E
NON-EXHAUSTED (DEFLECTOR LCK4000 REQUIRED)	•	0	0	4	•
EXHAUSTED	15	0	0	0	14 Max

CLOSET INSTALLATION	A	B	C	*** D	**F	G	**H	J
EXHAUSTED ONLY	15	0	0	4	24 sq. in.	1	48 sq. in.	3
Unobstructed air openings required for laundry equipment when door is installed.								

MINIMUM INSTALLATION SPACING

*Shelf or cabinet is not permitted above dryer when non-exhausted.

**Louvered door with equivalent air openings is acceptable.

***"D" Dimension must be measured from dryer cabinet rear panel.

Companion appliance spacings should be considered.

IMPORTANT OPERATING INFORMATION

1. Read Operating Instructions Book and Dryer Guide.
2. Dryer will not operate with the door open.
3. Keep lint screen and exhaust system clear of lint. A blocked screen or exhaust will cause slow drying and/or other malfunctions.

Do not operate dryer without lint screen. Using the dryer with the lint screen removed may cause overheating and possible damage to fabrics. Lint screen must be pushed firmly into place.

4. Be sure to dry only clothes or materials washed in water in your dryer. **Under no circumstances should items that have been cleaned with flammable cleaning fluids be placed in the dryer.** Plastic and rubber items must be dried on the "Air" setting.

5. If dryer will not operate, check the following to be sure that:

- A. Electric supply is connected.
- B. Both fuses are good and tight.
- C. Door is closed.
- D. Controls are set in a running or "On" position.
- E. Push start button firmly or the Power Control lever moved upward to start.

TYPICAL INSTALLATION

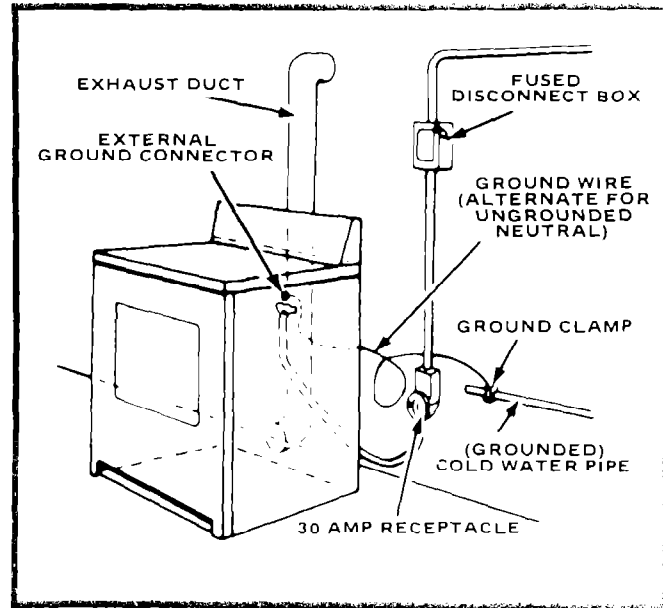

MOVING OPERATIONS PROCEDURE

1. Shut off electric supply to dryer by opening circuit breaker or fused disconnect.
2. Remove pigtail (if used) from 30 Amp receptacle, or disconnect from box (by licensed electrician), then remove armored cable from dryer at the dryer or disconnect box.
3. Make sure leveling legs are secure in dryer base.
4. Apply filament tape from inside drum, out the door opening to the front panel to prevent drum movement.
5. Use tape to secure clothes door and lint screen.
6. **WARNING:** Before having your electric dryer connected in your new residence, be sure your licensed electrician confirms that the supply voltage matches the voltage specified on the nameplate.

LITERATURE RACK INSTALLATION

1. Insert the 4 side tabs (2 on each side) of the rack into the back panel. (See Figure A.)
2. Push downward until all 4 tabs bottom out, locking the sides of the rack in place.
3. Insert the 2 bottom tabs into the slots at the base of the rear panel, until they lock in place. (See Figure B.)
4. Put all the literature in the Laundry Information Center folder and then put the folder in the rack.

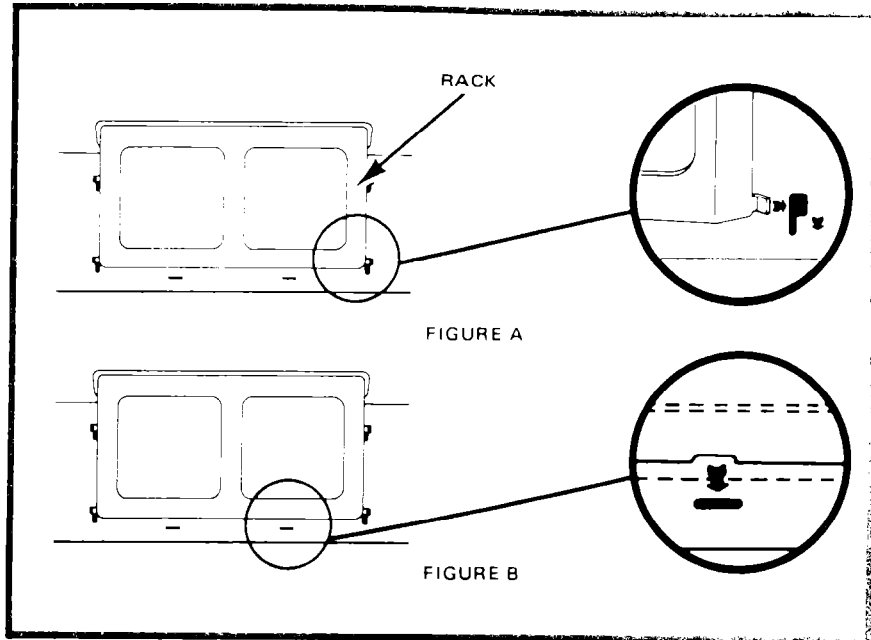



In the event your WHIRLPOOL appliance should need service, call the dealer from whom you purchased the appliance or a WHIRLPOOL franchised TECH-CARE® service company. He is in the Yellow Pages of your telephone directory listed under Washers, Dryers—Repairing or Servicing. You can also obtain his name and number by dialing, free, within the continental United States (except Alaska) the Whirlpool COOL-LINE® Service (800) 253-1301 [when calling from Michigan, dial (800) 632-2243; from Alaska or Hawaii, dial (800) 253-1121]. Dial just as you normally dial long distance. A special operator will tell you the name and number of your nearest Whirlpool TECH-CARE service outlet. During normal working hours, Whirlpool consultants at this same number will also answer any questions about operating or maintaining your appliance not covered in your Operating Instructions.

Learn the benefits of using TECH-CARE service for maintaining the quality originally built into your WHIRLPOOL appliance.



WHIRLPOOL CORPORATION BENTON HARBOR, MICHIGAN 49022