



HE^{3t}

Front-Loading Automatic Washer

Owner's Manual and Installation Instructions

Lavadora automática de carga frontal

Manual del propietario e Instrucciones de instalación

Laveuse automatique à chargement frontal

Manuel de l'utilisateur et Instructions d'installation

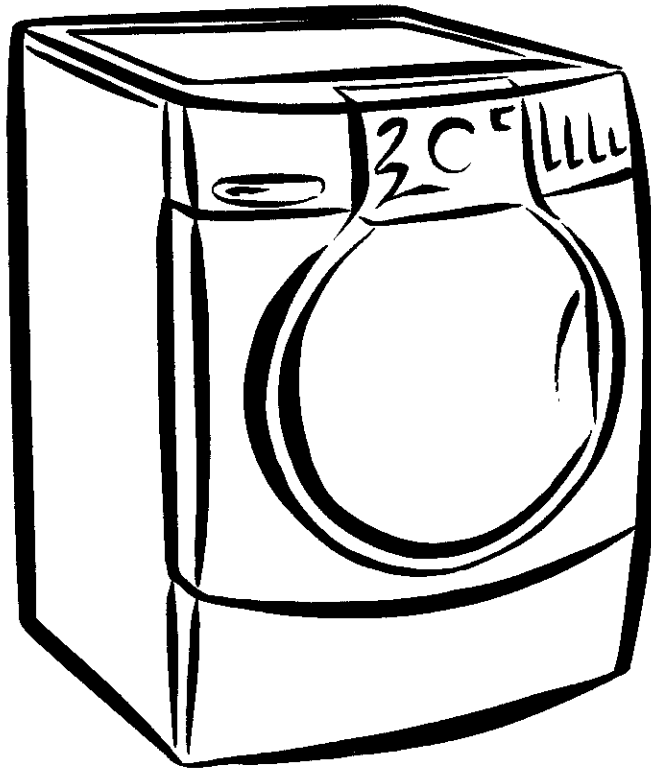

TABLE OF CONTENTS

WE SERVICE WHAT WE SELL	2
WARRANTY	3
PEDESTAL OPTION WARRANTY	3
WASHER SAFETY	4
INSTALLATION REQUIREMENTS	5
Tools and Parts	5
Alternate Parts You May Need.....	5
Optional Pedestal	5
Location Requirements	5
Drain System	6
Electrical Requirements.....	7
INSTALLATION INSTRUCTIONS	8
Remove Transport System.....	8
Route the Drain Hose	8
Connect the Inlet Hoses.....	8
Secure the Drain Hose	9
Level the Washer	9
Complete Installation.....	9
FEATURES AND BENEFITS	10
WASHER USE	11
Starting Your Washer	11
Using the Dispenser	12
Pausing or Restarting	13
Changing Cycles, Options and Modifiers	13
Status Lights.....	13
Cycles	14
Options	15
Modifiers	16
Laundry Guide	17
LAUNDRY TIPS	17
Loading	17
WASHER CARE	18
Cleaning Your Washer.....	18
Water Inlet Hoses	18
Vacation, Storage, and Moving Care.....	18
TROUBLESHOOTING	19

WE SERVICE WHAT WE SELL

Your purchase has added value because you can depend on Sears HomeCentral® for service. With over 12,000 trained repair specialists and access to over 4.2 million parts and accessories, we have the tools, parts, knowledge and skills to ensure our pledge: We Service What We Sell.

Sears Maintenance Agreements

Your Kenmore® appliance is designed, manufactured and tested to provide years of dependable operation. Yet any major appliance may require service from time to time. The Sears Maintenance Agreement offers you an outstanding service program, affordably priced.

The Sears Maintenance Agreement

- Is your way to buy tomorrow's service at today's price.
- Eliminates repair bills resulting from normal wear and tear.
- Provides for non-technical and instructional assistance.
- Even if you don't need repairs, provides an annual Preventive Maintenance Check, at your request, to ensure that your appliance is in proper running condition.

Some limitations apply. For more information, call 1-800-827-6655.

For information concerning Sears Canada Maintenance Agreements, call 1-800-361-6665.

WARRANTY

Limited Lifetime Warranty on Stainless Steel Drum

For the lifetime of the washer from the date of purchase, Sears will replace the Stainless Steel wash drum due to defective material or workmanship. You will be charged for labor after the first year.

Limited Ten-Year Warranty on Plastic Tub*

For the second through tenth year from the date of purchase, Sears will replace the plastic tub if defective in material or workmanship. You will be charged for labor after the first year.

Limited Five-Year Warranty on Drive System Parts*

For the second through fifth year from the date of purchase, Sears will replace the following drive system parts if defective in material or workmanship: drive pulley and drive belt. You will be charged for labor after the first year.

Limited Two-Year Warranty on SENSOR SMART™ Electronic Control Board

For two years from the date of purchase, Sears will replace the electronic control boards if defective in material or workmanship. You will be charged for labor after the first year.

Full One-Year Warranty on Mechanical and Electrical Parts

For one year from the date of purchase, when this washer is installed and operated according to the instructions provided in the Owner's Manual, Sears will repair or replace any of its mechanical or electrical parts if defective in material or workmanship.

Warranty Restriction

If the washer is subject to other than private family use, the above warranty coverage is effective for only 90 days.

Warranty Service

Warranty service is available by contacting the nearest Sears Service Center in the United States or Canada. This warranty applies only while the product is in use in the United States or Canada. This warranty gives you specific legal rights and you may also have other rights which vary from state to state or province to province.

*Warranty terms may vary in Canada.

Please reference the service numbers located on the back page of this manual.

Sears, Roebuck and Co.
D/817WA, Hoffman Estates, IL 60179

Sears Canada, Inc.
Toronto, Ontario, Canada M5B 2B8

In the space below, record your complete model number, serial number, and purchase date. You can find this information on the model and serial number label.

Have this information available to help you quickly obtain assistance or service when you contact Sears concerning your appliance.

Model number 110 _____

Serial number _____

Purchase date _____

Save these instructions and your sales receipt for future reference.

PEDESTAL OPTION WARRANTY

Full One-Year Warranty on Mechanical Parts

For one year from the date of purchase, when this pedestal is installed with this washer and is operated according to the instructions provided in the Owner's Manual, supplier will repair or replace any of its mechanical or electrical parts if defective in material or workmanship.

Warranty Restriction

If the pedestal is subject to other than private family use and or if the pedestal is used with any other product than those listed in the installation instructions, the above warranty coverage is null and void.

In the space below, record your complete model number, serial number, and purchase date. You can find this information on the model and serial number label.

Have this information available to help you quickly obtain assistance or service when you contact Sears concerning your appliance.

Model number 110 _____

Serial number _____

Purchase date _____

Save these instructions and your sales receipt for future reference.

ENGLISH

WASHER SAFETY

Your safety and the safety of others are very important.

We have provided many important safety messages in this manual and on your appliance. Always read and obey all safety messages.



This is the safety alert symbol.

This symbol alerts you to potential hazards that can kill or hurt you and others.

All safety messages will follow the safety alert symbol and either the word "DANGER" or "WARNING." These words mean:

⚠ DANGER

You can be killed or seriously injured if you don't immediately follow instructions.

⚠ WARNING

You can be killed or seriously injured if you don't follow instructions.

All safety messages will tell you what the potential hazard is, tell you how to reduce the chance of injury, and tell you what can happen if the instructions are not followed.

IMPORTANT SAFETY INSTRUCTIONS

WARNING: To reduce the risk of fire, electric shock, or injury to persons when using the washer, follow basic precautions, including the following:

- Read all instructions before using the washer.
- Do not wash articles that have been previously cleaned in, washed in, soaked in, or spotted with gasoline, dry-cleaning solvents, other flammable, or explosive substances as they give off vapors that could ignite or explode.
- Do not add gasoline, dry-cleaning solvents, or other flammable, or explosive substances to the wash water. These substances give off vapors that could ignite or explode.
- Under certain conditions, hydrogen gas may be produced in a hot water system that has not been used for 2 weeks or more. **HYDROGEN GAS IS EXPLOSIVE.** If the hot water system has not been used for such a period, before using the washing machine, turn on all hot water faucets and let the water flow from each for several minutes. This will release any accumulated hydrogen gas. As the gas is flammable, do not smoke or use an open flame during this time.
- Do not allow children to play on or in the washer. Close supervision of children is necessary when the washer is used near children.
- Before the washer is removed from service or discarded, remove the door or lid.
- Do not reach into the washer if the drum, tub or agitator is moving.
- Do not install or store the washer where it will be exposed to the weather.
- Do not tamper with controls.
- Do not repair or replace any part of the washer or attempt any servicing unless specifically recommended in this manual or in published user-repair instructions that you understand and have the skills to carry out.
- See "Electrical Requirements" for grounding instructions.

SAVE THESE INSTRUCTIONS

INSTALLATION REQUIREMENTS

Tools and Parts

Assemble the necessary tools and supplies before beginning the washer installation. The parts supplied are in the washer drum.

Tools needed for connecting the water inlet hoses

- Pliers (that open to 1 1/16 in. [39.5 mm])
- Flashlight (optional)

Tools needed for installation

- Open end wrench 5/8 in. (17 mm) and 1/2 in. (13 mm)
- Level
- Wood block (2" x 4")
- Ruler or measuring tape

Parts supplied:



Beaded strap

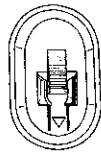

Transport bolt hole plug (4)

Alternate Parts You May Need

Parts listed are available from your local Sears store or Sears Service Center. Please reference the service numbers located on the back of this manual.

If You Have	You Will Need to Buy
Laundry tub or standpipe taller than 96 in. (2.4 m)	Sump pump system (if not already available)
Overhead sewer	Standard 20 gal. (76 L), 30 in. (76.2 cm) tall drain tub or utility sink and sump pump (available from local plumbing suppliers)
Floor drain	Siphon break, Part Number 285834; additional drain hose Part Number 8318155; and connector kit, Part Number 285835
Drain hose too short	Drain hose extension kit, Part Number 285863
Water faucets beyond reach of fill hoses	2 longer water fill hoses: 6 ft (1.8 m) Part Number 76314, 10 ft (3.0 m) Part Number 350008

Optional Pedestal

A pedestal may be purchased separately for this washer. This pedestal will add about 14 inches to the height of your unit for a total vertical height of approximately 52 inches (132 cm).

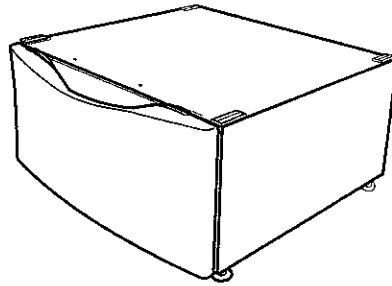

Optional Pedestal

This pedestal is available in three colors:

White - Part Number 4282

Bisque - Part Number 4284

Graphite - Part Number 4286

To order, call your local Sears store or Sears Service Center. For further information, please reference the service numbers located on the back page of this manual.

Location Requirements

Selecting the proper location for your washer improves performance and minimizes noise and possible washer "walk."

Your washer can be installed under a custom counter, or in a basement, laundry room, closet, or recessed area. (See "Drain System.")

Companion appliance location requirements should also be considered. Proper installation is your responsibility.

You will need

- A water heater set to deliver 120°F (49°C) water to the washer.
- A grounded electrical outlet located within 5 ft (1.5 m) of where the power cord is attached to the back of the washer. (See "Electrical Requirements.")
- Hot and cold water faucets located within 4 ft (1.2 m) of the hot and cold water fill valves, and water pressure of 20-100 psi (137.9-689.6 kPa).
- A level floor with a maximum slope of 1 in. (2.5 cm) under entire washer. Installing the washer on carpeting is not recommended.
- A sturdy and solid floor to support the washer with a total weight (water and load) of 400 lbs (180 kg).

Do not operate your washer in temperatures below 32°F (0°C). Some water can remain in the washer and can cause damage in low temperatures.

Washer Dimensions

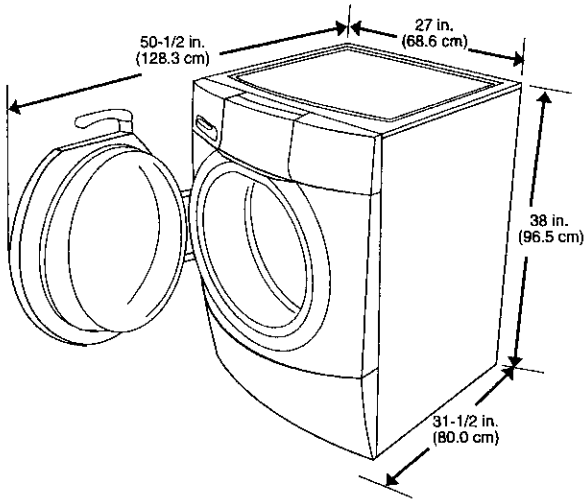

Custom undercounter installation

The dimensions shown are for the minimum spacing allowed

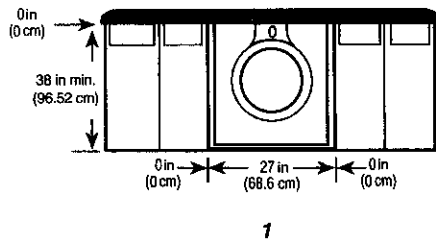

1

Recessed area or closet installation

The dimensions shown are for the minimum spacing allowed.

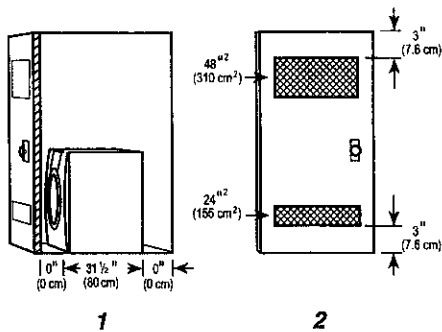

1

2

1. Side view - closet or confined area
2. Closet door with vents

- Additional spacing should be considered for ease of installation and servicing.
- Additional clearances might be required for wall, door and floor moldings.
- Additional spacing of 1 in. (2.5 cm) on all sides of the washer is recommended to reduce noise transfer.
- For closet installation, with a door, the minimum ventilation openings in the top and bottom of the door are required (view 2). Louvered doors with equivalent ventilation openings in the top and bottom are acceptable.

Drain System

The washer can be installed using the standpipe drain system (floor or wall), the laundry tub drain system, or the floor drain system. Select the drain hose installation method you need. (See "Alternate Parts You May Need.")

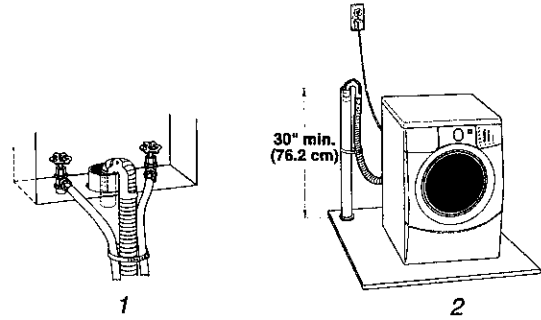

1

2

Standpipe drain system - wall or floor (view 1 & 2)

The standpipe drain requires a minimum diameter standpipe of 2 in. (5 cm). The minimum carry-away capacity can be no less than 17 gal. (64 L) per minute.

The top of the standpipe must be at least 30 in. (76.2 cm) high and no higher than 96 in. (2.4 m) from the bottom of the washer.

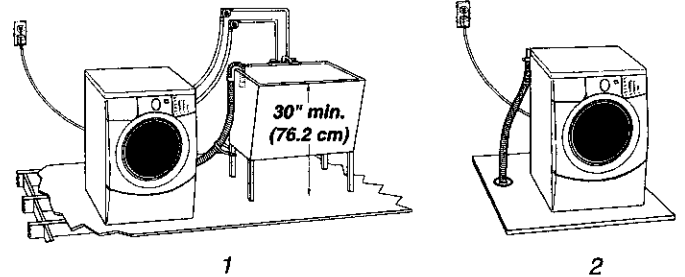

1

2

Laundry tub drain system (view 1)

The laundry tub needs a minimum 20 gal. (76 L) capacity. The top of the laundry tub must be at least 30 in. (76.2 cm) above the floor.

Floor drain system (view 2)

The floor drain system requires a siphon break that may be purchased separately. (See "Alternate Parts You May Need.")

The siphon break must be a minimum of 28 in. (71 cm) from the bottom of the washer. Additional hoses might be needed.

Electrical Requirements

⚠ WARNING



Electrical Shock Hazard

Plug into a grounded 3 prong outlet.

Do not remove ground prong.

Do not use an adapter.

Do not use an extension cord.

Failure to follow these instructions can result in death, fire, or electrical shock.

- A 120-volt, 60-Hz., AC-only, 15- or 20-ampere, fused electrical supply is required. Time-delay fuse or circuit breaker is recommended. It is recommended that a separate circuit serving only this appliance be provided.
- This washer is equipped with a power supply cord having a 3 prong ground plug.
- To minimize possible shock hazard, the cord must be plugged into a mating, 3 prong, ground-type outlet, grounded in accordance with local codes and ordinances. If a mating outlet is not available, it is the personal responsibility and obligation of the customer to have the properly grounded outlet installed by a qualified electrician.
- If codes permit and a separate ground wire is used, it is recommended that a qualified electrician determine that the ground path is adequate.
- Do not ground to a gas pipe.
- Check with a qualified electrician if you are not sure the washer is properly grounded.
- Do not have a fuse in the neutral or ground circuit.

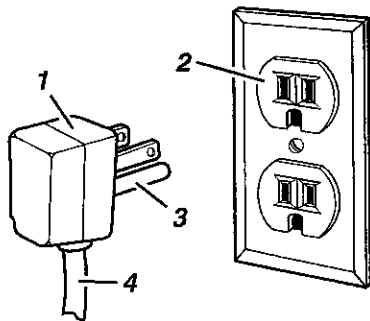

1. 3 prong grounding plug
2. 3 prong grounding-type wall receptacle
3. Grounding prong
4. Power supply cord

GROUNDING INSTRUCTIONS

For a grounded, cord-connected washer:

This washer must be grounded. In the event of a malfunction or breakdown, grounding will reduce the risk of electrical shock by providing a path of least resistance for electric current. This washer is equipped with a cord having an equipment-grounding conductor and a grounding plug. The plug must be plugged into an appropriate outlet that is properly installed and grounded in accordance with all local codes and ordinances.

WARNING: Improper connection of the equipment-grounding conductor can result in a risk of electric shock. Check with a qualified electrician or serviceman if you are in doubt as to whether the appliance is properly grounded.

Do not modify the plug provided with the appliance – if it will not fit the outlet, have a proper outlet installed by a qualified electrician.

For a permanently connected washer:

This washer must be connected to a grounded metal, permanent wiring system, or an equipment grounding conductor must be run with the circuit conductors and connected to the equipment-grounding terminal or lead on the appliance.

ENGLISH

INSTALLATION INSTRUCTIONS

Remove Transport System

⚠ WARNING

Excessive Weight Hazard

Use two or more people to move and install washer.

Failure to do so can result in back or other injury.

IMPORTANT: Position the washer so that the rear of the unit is within approximately 3 feet (90 cm) of the final location.

There are 4 bolts in the rear panel of the washer that support the suspension system during transportation.

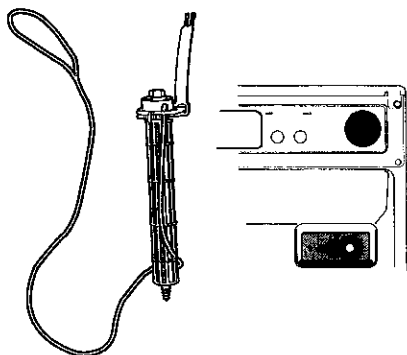

1. Using a ½ in. (13 mm) wrench, loosen each of the bolts.
2. Once the bolt is loose, move it to the center of the hole and completely pull out the bolt, including the red plastic spacer covering the bolt and the cable attached to the bolt. The power cord will be attached to all 4 bolts.

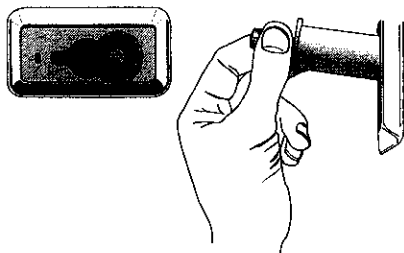

3. Once all 4 bolts are removed, remove the power cord from each bolt holder, and discard bolts, red plastic spacers, and cables.
4. Close the holes with the transport bolt hole plugs.

Route the Drain Hose

Proper routing of the drain hose protects your floors from damage due to water leakage. Carefully read and follow these instructions.

The drain hose is connected to your washer.

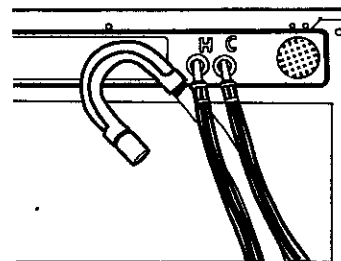

To prevent drain water from going back into the washer:

- Do not straighten the drain hose, and do not force excess drain hose into standpipe. Hose should be secure, but loose enough to provide a gap for air.
- Do not lay excess hose on the bottom of the laundry tub.

Floor drain

You may need additional parts. (See Floor Drain under "Alternate Parts You May Need.")

Connect the Inlet Hoses

Connect the inlet hoses to the water faucets

Make sure the washer drum is empty.

1. Attach the hose with the red color indicator to the hot water faucet. Screw on coupling by hand until it is seated on the washer.
2. Attach the hose with the blue color indicator to the cold water faucet. Screw on coupling by hand until it is seated on the washer.
3. Using pliers, tighten the couplings with an additional two-thirds turn.

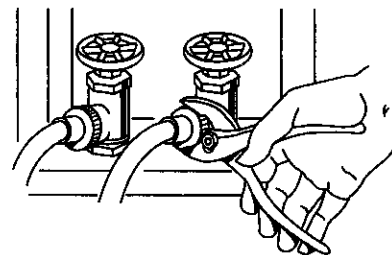

NOTE: Do not overtighten. Damage to the coupling can result.

4. Turn on the water faucets and check for leaks.

NOTE: Replace inlet hoses after 5 years of use to reduce the risk of hose failure. Record hose installation or replacement dates on the hoses for future reference.

Periodically inspect and replace hoses if bulges, kinks, cuts, wear, or leaks are found.

Secure the Drain Hose

1. Drape the power cord over the washer top.
2. Secure the drain hose to the laundry tub leg or standpipe with the beaded strap provided. (See illustration.)

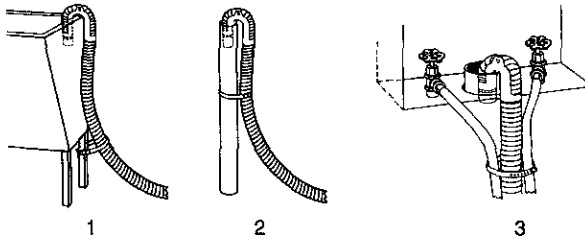

If the washer faucets and the drain standpipe are recessed, put the hooked end of the drain hose in the standpipe. Tightly wrap the beaded strap around the water inlet hoses and the drain hose.

Do not force excess drain hose into the standpipe.

Level the Washer

Properly leveling your washer prevents excessive noise and vibration.

1. Check the levelness of the washer by placing a level on the top edge of the washer, first side-to-side, then front-to-back.

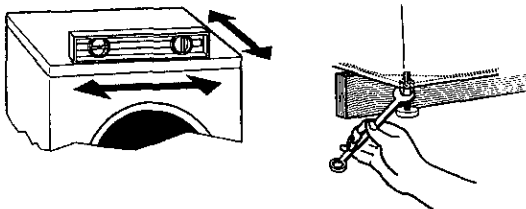

If the washer is against a wall, move the washer out slightly before tipping back. If the washer is not level, first prop the front with a wood block (2" x 4") and adjust the feet as necessary; then prop the back and adjust feet as necessary. Repeat this step until washer is level.

2. After the washer is level, use a $\frac{5}{16}$ in. (17 mm) open-end wrench to turn the nuts on the feet tightly against the washer cabinet.

All 4 feet must be tightened. If the nuts are not tight against the washer cabinet, the washer may vibrate.

3. Slide the washer to its final location.
4. Confirm the levelness of the washer.

Complete Installation

1. Check the electrical requirements. Be sure that you have the correct electrical supply and the recommended grounding method. (See "Electrical Requirements.")
2. Check to be sure all parts are now installed. If there is an extra part, go back through the steps to see which step was skipped.
3. Check to be sure you have all of your tools.
4. Dispose/recycle all packaging materials.
5. Check to be sure the water faucets are on.
6. Check for leaks around faucets and inlet hoses.

⚠ WARNING



Electrical Shock Hazard

Plug into a grounded 3 prong outlet.

Do not remove ground prong.

Do not use an adapter.

Do not use an extension cord.

Failure to follow these instructions can result in death, fire, or electrical shock.

7. Plug into a grounded 3 prong outlet.
8. Read "Washer Use."

To test and to clean your washer, measure $\frac{1}{2}$ the normal recommended amount of powdered or liquid High Efficiency (HE) detergent or $\frac{1}{4}$ the normal recommended amount of regular powdered or liquid detergent. Pour the detergent into the detergent dispenser. Select NORMAL/CASUAL, and then select START. Allow the washer to complete one whole cycle.

FEATURES AND BENEFITS

Flexible Electronic Controls

Flexible electronic controls are easy to use whether you are a beginner or an expert.

Smart Dispensers

The Smart Dispensers make your washer truly automatic. It is unnecessary for you to return to the washer during the cycle to add detergent, bleach, or fabric softener.

Laundry products are diluted with fresh water and added to the load at the proper time in the wash cycle.

Auto Water Level

This washer automatically adjusts water level for best cleaning and rinsing performance. Two sensors determine load size, load composition, and suds level, then the sensors adjust the water level to the proper setting. This eliminates guesswork. The water level is just right for every wash load size.

Larger Load Size

Since there is no agitator, you can wash larger, bulkier items like an average size sleeping bag. You are also able to wash more clothes at one time, which means fewer loads. You can wash a pillow or a large stuffed teddy bear.

Suspension System

To reduce washer "walk" and "off-balance" conditions, your new washer combines:

- 2 Springs to isolate vibration
- 4 Shock absorbers at the washer base to minimize movement

Stainless Steel Drum

The Stainless Steel drum eliminates corrosion and enables higher spin speeds for more water extraction, reducing drying time.

High-Efficiency Wash System

Your new front-loading, high-efficiency washer saves time with fewer, larger loads, conserves resources and lowers your water and energy bills too.

Spin Speeds

This washer automatically selects the spin speed based on the cycle selected. This factory setting can be changed, however. This washer offers up to six different spin speed choices.

Heating Element and Automatic Temperature Control (ATC)

This washer has a heating element that automatically heats the water to the best temperature on select cycles. This enables stepped cleaning, a process in which warm water is brought in and mixed with detergent first, then the water is heated. The warm water cleans stains such as blood and eggs, and the heated water removes stains such as perspiration and dirty mechanical oil. This heater is active in the Stain Treat and Sanitary cycles.

Dispenser Drawer

This washer provides a four-compartment dispenser which includes separate compartments for main wash detergent, fabric softener, bleach, and auto prewash or auto soak. The dispenser has large pour zones, is self-cleaning, and can be easily removed.

Add A Garment

At the beginning of a cycle, this washer allows an 8-minute period in which forgotten garments may be added to a load without waiting for the door to unlock. The ADD A GARMENT status light will glow during this 8-minute period.

Direct Injection

This washer channels 100% of the water through the dispensers to assure thorough rinse-out and mixture of all the additives before they touch any garments. The water is then sprayed from the top front onto the center of the load, providing even distribution and optimum cleaning performance. It is normal for small amounts of water to remain in the dispensers when the wash cycle is complete.

Eco Valve

This washer has a specially designed valve that closes during the wash portion of the cycle so that 100% of the water and detergent mixture is used on the load. The Eco Valve insures that no water or detergent is wasted.

Off-Balance Detection and Correction

This washer uses two sensors to detect load size and the amount of off-balance within the load. The suspension system and controls are specially designed to redistribute the load automatically.

WASHER USE

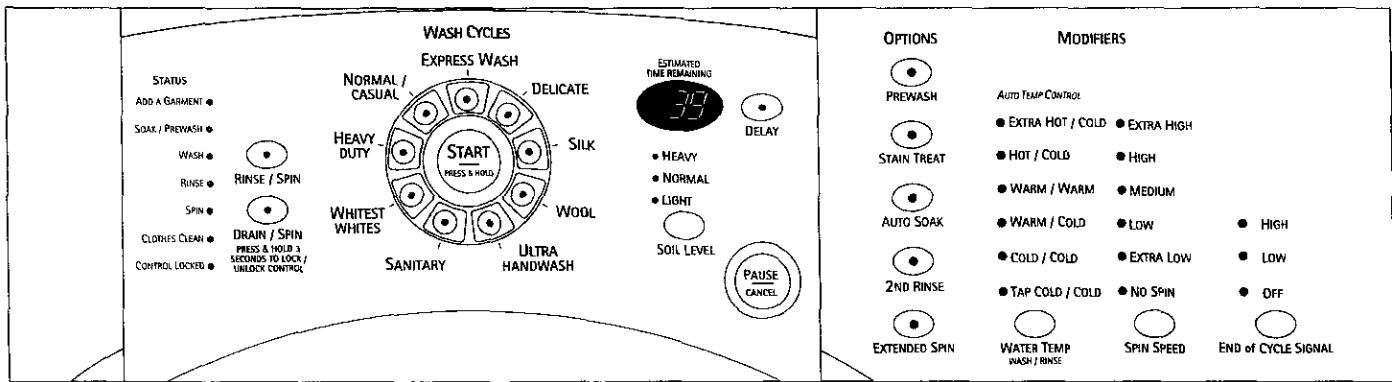

Starting Your Washer

⚠ WARNING



Fire Hazard

Never place items in the washer that are dampened with gasoline or other flammable fluids.

No washer can completely remove oil.

Do not dry anything that has ever had any type of oil on it (including cooking oils).

Doing so can result in death, explosion, or fire.

The following is a guide to using your washer. Please refer to specific sections of this manual for more detailed information. Do not store laundry products on the top surface of this washer. Vibration is normal during operation.

First Wash Cycle Without Laundry

Before washing clothes for the first time, choose NORMAL / CASUAL cycle and run it without clothes. After installation, if a complete cycle has not been run without clothes, use ½ the normal recommended amount of powdered or liquid High Efficiency (HE) detergent or ¼ the normal recommended amount of regular powdered or liquid detergent. This initial cycle serves to ensure the interior is clean before washing clothes.

1. To load washer

Open the washer door by pulling on the handle. Sort laundry according to color and type of fabric. Place a load of sorted clothes in the washer. Do not overload washer. Overloading can cause poor cleaning.

- The washer can be fully loaded, but not tightly packed. Washer door should close easily.
- Mix large and small items. Load evenly.
- It is recommended that you wash small items such as infant socks in a mesh garment bag.
- When unloading garments, occasionally check under the rubber rim at the front of the tub for small items.

2. Close the washer door by pushing it firmly until the lock clicks. The washer door will remain locked during the wash cycle.

NOTE: After any wash cycle is completed, the door must be opened and then closed before a new cycle can begin. The door can be opened only if PAUSE/CANCEL is selected while the ADD A GARMENT light is glowing or if the cycle has been cancelled. See "Cancelling a Cycle."

3. Open the Dispenser Drawer and add laundry products to the detergent, bleach, or fabric softener compartments. Close drawer slowly to avoid spills. See "Using the Dispenser."

NOTE: For best performance, use High Efficiency detergents. The package for this type of detergent will be marked "HE" or "High Efficiency." The HE^t "wash action" along with less water could create too much sudsing with a regular detergent.

4. Turn on the washer by selecting one of the WASH CYCLES. The indicator light for the selected cycle will glow. When selecting a Wash Cycle, the preset cycle, Water Temp, Spin Speed, and soil level for the selected cycle will glow. The display shows the estimated time remaining. The preset settings provide the recommended fabric care for the selected cycle. See "Wash Cycles."

5. Select the desired OPTIONS. See "Options."

6. If desired, select the END OF CYCLE SIGNAL. The signal is helpful when you are washing items that should be removed from the washer as soon as it stops. Select HIGH or LOW.

7. **To begin the wash cycle immediately**

Select and hold START (for approximately 1 second).

- If you do not select START within 5 minutes of choosing a cycle, the washer automatically shuts off.
- When the wash cycle is complete, the CLOTHES CLEAN status light glows, the door unlocks, and the wash load can be removed from the washer. The washer powers down automatically 5 minutes after the cycle is complete. To power down the washer manually after the wash cycle is complete, select PAUSE/CANCEL once.

8. **To begin the wash cycle later**

Select DELAY until the desired delay time (in hours) shows in the Estimated Time Remaining display. Select START. The countdown to the wash cycle will show in the display window.

ENGLISH

Using the Dispenser

Your new washer has a dispenser drawer with four separate compartments for your laundry products—two are for detergent, one is for liquid chlorine bleach, and one is for liquid fabric softener. Laundry products are diluted and dispensed automatically at the proper time during the wash cycle, making it unnecessary for you to return to the washer during the cycle to add them.

It is normal for small amounts of water to remain in the dispensers when the wash cycle is complete.

Do not put laundry additives directly into the wash tub. Always use the proper dispensers when adding laundry products.

Choosing the Right Detergent

For best washing performance, use a High Efficiency (HE), or low-sudsing, detergent. Regular detergents may cause oversudsing in the washer. If a High Efficiency detergent is unavailable, use $\frac{1}{2}$ the recommended amount of regular detergent.

To fill dispenser compartments

1. Pull out the dispenser drawer.
2. Add the desired laundry product to the proper compartment.
3. Push in the dispenser drawer completely.

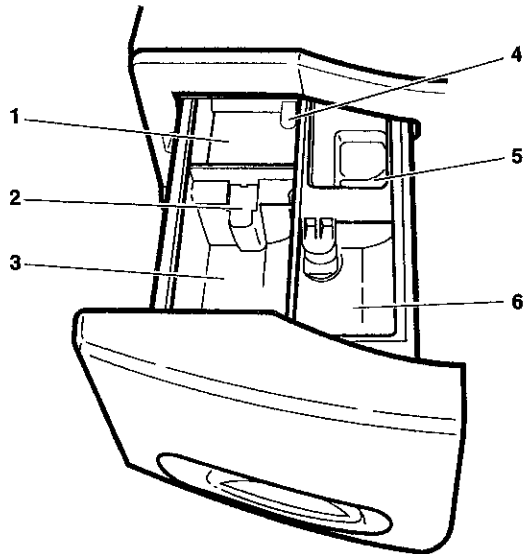

Dispenser

1. Prewash detergent compartment
2. Separator
3. Main Wash detergent compartment
4. Dispenser release lever
5. Bleach compartment
6. Fabric softener compartment

Prewash detergent compartment

(Number 1 in Dispenser Illustration)

Add detergent to this compartment when using the Prewash option or Auto Soak. Liquid or powdered detergent may be used in this compartment. The detergent will automatically be dispensed during Prewash if the Prewash option is selected or during the soak time if Auto Soak is selected.

- If you use High Efficiency (HE) detergent, add $\frac{1}{3}$ the recommended amount to the prewash compartment and $\frac{2}{3}$ the recommended amount to the main wash compartment.
- If you use regular detergent, add $\frac{1}{6}$ of the recommended amount to the prewash compartment and $\frac{1}{2}$ of the recommended amount to the main wash compartment.

Main Wash detergent compartment

(Number 3 in Dispenser Illustration)

Add liquid or powdered detergent to this compartment for your main wash cycle. The detergent separator must always be in place, either in the front or back position.

IMPORTANT: If you are using the Prewash option, the Auto Soak with a wash cycle, or Delay, powdered detergent must be used in the main wash compartment since liquid detergents may seep out of the main wash compartment during the prewash, soak time, or delay before the main wash begins.

- Do not fill beyond the "MAX" level.
- Liquid or powdered color-safe bleach may be added to the Main Wash compartment along with the same type of detergent, liquid or powdered.
- **Liquid detergent:** Put the SEPARATOR in the front position, between the guides, as shown following. There will be no gap between the bottom of the wash cycle detergent compartment and the bottom of the separator.

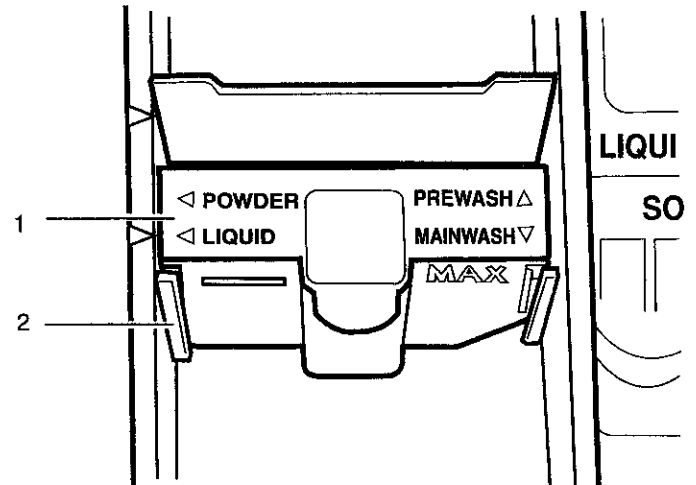

Separator in front position, between guides

1. Separator
2. Guide

- **Powdered detergent:** Put the SEPARATOR in the back position, behind the guides, as shown following. There will be a gap between the bottom of the wash cycle detergent compartment and the bottom of the separator.

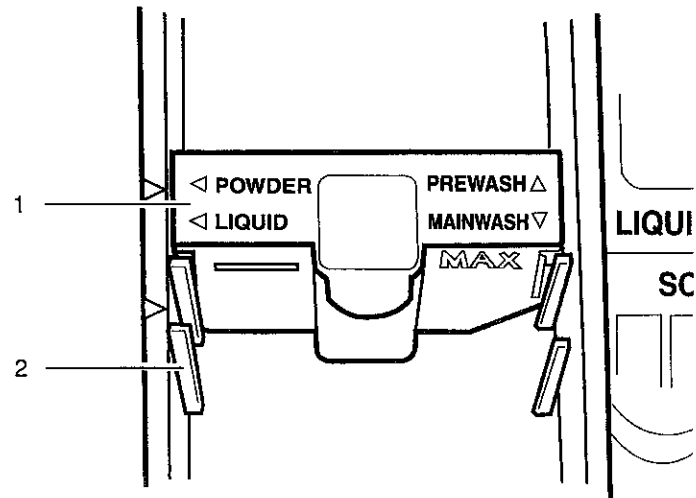

Separator in back position, behind guides

1. Separator
2. Guide

NOTE: The separator will be in the liquid (front) position when shipped from the factory.

Bleach compartment

(Number 5 in Dispenser Illustration)

Add **NO MORE THAN** 1/3 cup liquid chlorine bleach to this compartment. The bleach will be automatically diluted and dispensed at the proper time during the wash cycle. This compartment cannot dilute powdered bleach.

- Always measure liquid chlorine bleach. Use a measuring cup with a pour spout; do not guess.
- Do not fill beyond the "MAX" level. Overfilling could cause severe garment damage.

Fabric Softener compartment

(Number 6 in Dispenser Illustration)

Add 1/4 cup liquid fabric softener to this compartment. Fabric softener will be automatically dispensed in the final rinse.

- Do not fill beyond the "MAX" level.

Pausing or Restarting

1. To pause the washer at any time, select PAUSE/CANCEL.
2. To continue the cycle, select and hold START (for approximately 1 second).

Changing Cycles, Options and Modifiers

Cycles, Options and Modifiers can be changed anytime before START is selected.

Options and Modifiers can be changed anytime after START is selected and before the start of the selected Option or Modifier.

To cancel a cycle and select a new cycle

1. Select PAUSE/CANCEL twice.
2. Select desired cycle.
3. Select the desired OPTIONS.
4. Select and hold START (for approximately 1 second) to restart the washer at the beginning of the new cycle.

To cancel a cycle

1. Select PAUSE/CANCEL twice.
2. The washer powers down, the door unlocks, and clothes can be removed.

To change Options or Modifiers after the cycle has started

1. Select PAUSE/CANCEL.
2. Select the desired OPTIONS or MODIFIERS.
3. Select and hold START (for approximately 1 second) to continue the cycle.

NOTE: If the water level or the temperature is too high, the washer will drain automatically before the door unlocks.

To drain the washer manually

1. Select PAUSE/CANCEL.
2. Select DRAIN/SPIN.
3. Select and hold START (for approximately 1 second) to begin the drain.
4. When the spin is complete, the door unlocks. Items can be removed from the washer.

Status Lights

These lights show which portion of the cycle the washer is operating. They also indicate when you can add an additional item to the wash cycle and when the controls are locked.

STATUS

ADD A GARMENT ●

SOAK / PREWASH ●

WASH ●

RINSE ●

SPIN ●

CLOTHES CLEAN ●

CONTROL LOCKED ●

Adding items

You can add items to the washer after the cycle has started if the ADD A GARMENT status light is glowing.

To add items

1. Select PAUSE/CANCEL. The washer door unlocks, and items can be added.
2. To continue the cycle, close the door and select and hold START (for approximately 1 second).

Locking controls

The Control Lock prevents unintended use of the washer. You can also use the control lock feature to prevent unintended cycle or option changes during a cycle. When CONTROL LOCKED is lit, all buttons are disabled. You can lock the washer while it is operating.

To lock the controls

Select and hold DRAIN/SPIN for 3 seconds.



The CONTROL LOCKED status light glows.

To unlock the controls

Select and hold DRAIN/SPIN for 3 seconds until the CONTROL LOCKED Status light turns off.

Cycles

Wash Cycles

Choose Wash Cycles by selecting the button next to the desired cycle. Each cycle is designed for different types of fabric and soil levels.

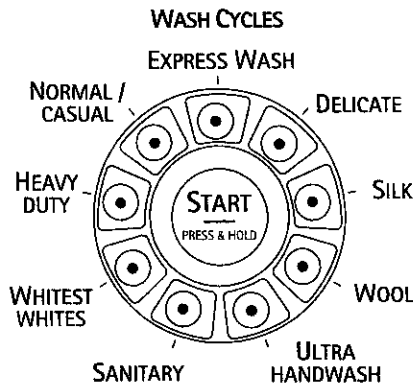

- Each cycle has a preset Soil Level (cycle time), Water Temperature, and Spin Speed. The preset settings provide the recommended fabric care for the selected cycle.
- The preset settings can be changed anytime before START is selected. (To change settings after the cycle has started, select PAUSE/CANCEL, then select the desired settings. Select and hold START (for approx. 1 second) to continue the cycle.)

Preset cycle settings

Each cycle has a preset Cycle Time, Water Temp, and Spin Speed. The preset settings provide the recommended fabric care for the selected cycle. See chart.

Cycle	Soil Level (cycle time)	Water Temp	Spin Speed
Sanitary	More (120 min.)	Extra Hot/Cold	Extra High
Whitest Whites	More (70 min.)	Hot/Cold	Extra High
Heavy Duty	More (90 min.)	Hot/Cold	Extra High
Normal/ Casual	Normal (45 min.)	Warm/Cold	High
Express Wash	Less (35 min.)	Warm/Cold	Extra High
Delicate	Normal (35 min.)	Warm/Cold	Low
Silk	Normal (30 min.)	Cold/Cold	No spin
Wool	Normal (35 min.)	Cold/Cold	Low
Ultra Handwash	Normal (35 min.)	Cold/Cold	Extra Low

Sanitary

Use this cycle to clean heavily soiled colorfast fabrics. This cycle combines a very hot water temperature and fast speed tumbling to help ensure the removal of heavy soils and stains. It is recommended that you set your hot water heater to 120° F (49° C) to ensure proper performance during this cycle. The Sanitary cycle also helps kill bacteria, even when no bleach is used. Extra high speed spin helps shorten drying time.

Whitest Whites

This cycle is especially designed for cleaning loads of soiled white fabrics with the addition of bleach. Hot washing temperatures assure optimal bleach activity. An additional rinse provides optimal rinse performance to avoid chlorine residues on your laundry. This cycle combines fast speed tumbling, longer wash time, and extra high speed spin to shorten drying time.

Heavy Duty

Use this cycle to wash loads of sturdy, colorfast fabrics and normally soiled garments. This cycle combines fast speed tumbling, longer wash time, and extra high speed spin to shorten drying times. If the water temperature is lower than needed for this cycle, the heater will warm the water to the optimum temperature.

NOTE: Stain Treat is a default option for this cycle. To ensure best performance, the water is heated as the cycle progresses. This gradual heating assists in the removal of organic soils such as blood.

Normal/Casual

Use this cycle to wash loads of no-iron fabrics such as sport shirts, blouses, casual business clothes, permanent press blends, cottons and linens, and synthetic fabrics. This cycle combines medium speed tumbling, high speed spin, and a load cooling process to reduce wrinkling.

Express Wash

Use this cycle to wash small loads of lightly soiled garments that are needed in a hurry. This cycle combines fast speed tumbling, a shortened wash time, and extra high speed spin to shorten drying time.

Delicate

Use this cycle to wash sheer fabrics and lingerie. This cycle combines low speed tumbling and low speed spin for gentle fabric care.

Silk

Use this cycle to clean washable silk garments. (Check label instructions to make sure that garment is washable.) This cycle gently tumbles and drains without spinning to gently clean garments and minimize wrinkling. Because there is no spinning action, garments will contain a higher amount of water at the end of this cycle.

Wool

Use this cycle to clean washable woolen garments. (Check label instructions to make sure that garment is washable.) This cycle features gentle tumbling and low speed spin to minimize creasing and shrinkage.

Ultra Handwash

Use this cycle to clean hand washable and special-care garments. Similar to the way garments are hand washed in a sink, the wash action of this cycle combines periods of extra low speed tumbling and soaking. Extra low speed spin reduces wrinkling.

Extra Cycles

Extra Cycles can be chosen by selecting the button above the desired cycle.

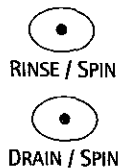

You can change the selection anytime before START is selected.

Rinse/Spin

Use this cycle to get a rinse and spin only. This cycle combines fast speed tumbling and extra high speed spin. If desired, you can reduce the spin speed by selecting the speed you want from the SPIN SPEED modifier.

Rinse/Spin is useful for

- Loads that need rinsing only.
- Adding fabric softener to a load using the fabric softener dispenser.

Drain/Spin

Use this cycle to drain your washer or to drain and spin your wash load. The spin speed is preset to extra high. If desired, you can reduce the spin speed by selecting the speed you want from the SPIN SPEED modifier.

NOTE: Loads of synthetics, delicate fabrics, handwashables, and woolens should be drained with no spin or low spin to avoid fabric stress.

Normal Washer Sounds

As with any new product, you will hear sounds that you are not accustomed to. You may hear various sounds when the door is locked and unlocked, and during the washing, rinsing, and spinning process. Between changes in wash actions, there will be momentary pauses. You will hear water spraying and splashing during the wash and rinse cycles. These new sounds and pauses are part of normal washer operation. (See "Troubleshooting.")

Options

You can customize your wash by adding OPTIONS to your cycle selections. You can add or change an option after starting a cycle anytime before the selected option begins.

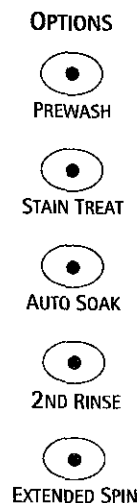

- See the "Laundry Guide" for an overview of possible options for each Wash Cycle selection.

- You can select more than one option for a cycle. Some options cannot be added to some cycles, for example, Stain Treat cannot be added to the Express Wash cycle.
- If an option is available with a selected cycle, the light for that option will glow when selected.
- If an option is unavailable with a selected cycle, there will be a short tone and the light for that option will **not** glow when selected.

Prewash

Use this option for loads of heavily soiled loads that need pretreatment. This option adds a 15 minute prewash and drain to the main wash cycle.

- Add detergent to the Prewash and Main Wash compartments of the Dispenser Drawer.
- When using Prewash, do not use liquid detergent in the Main Wash compartment. Use powdered detergent for the main wash cycle.

NOTE: The Prewash and Auto Soak options cannot be selected in the same cycle.

Stain Treat

Use this option for heavily soiled loads that need improved stain treatment. When Stain Treat is selected, the water temperature of the selected wash cycle is automatically set to warm. The water will then be heated to a hot water temperature to aid in stain removal. This option will provide optimal removal of organic stains such as blood.

NOTE: If Stain Treat is selected with the Sanitary cycle, the water will be heated to a very hot temperature.

Auto Soak

Use the Auto Soak option for loads of heavily soiled cotton, linen, polyester or nylon with set-in stains. During Auto Soak, water will be added to the drum and the laundry will be equally distributed by a short tumbling phase. Laundry will then be soaked by phases without drum movement. After soaking, the washer drains without spinning.

Added to a Wash Cycle: A 30 minute soak time is added to the main wash cycle to improve removal of set-in stains.

1. Add detergent to both the Prewash and Main Wash compartments of the Dispenser Drawer.

NOTE: The Auto Soak and Prewash options cannot be selected in the same cycle. Use powdered detergent for the main wash cycle because liquid detergent will seep into the washer during Auto Soak.

2. Select a Wash Cycle.
3. Select AUTO SOAK.

NOTE: For cycles with hot wash temperatures, the soak temperature will be set to warm; otherwise, the soak temperature will be the same as the wash temperature.

4. Select and hold START (approximately 1 second). After soaking, the washer drains and the wash cycle starts.

Without a Wash Cycle: Provides a soak time with warm or cold water followed by drain.

1. Add detergent only to the Prewash compartment of the Dispenser Drawer.
2. Select DRAIN/SPIN or RINSE/SPIN first, then AUTO SOAK.
3. Choose the desired soak temperature.
4. Select and hold START (approximately 1 second).

2nd Rinse

A second rinse can be used to ensure the removal of detergent or bleach residue from garments. This option provides an additional rinse with the same water temperature as the first rinse.

Extended Spin



Use this option to add an additional spin to any cycle to improve the “fluff” of your laundry, to reduce drying time, and to save energy.

Modifiers

Preset cycle settings of Water Temperature, Wash/Rinse, and Spin Speed can be changed. You can change a modifier after starting a cycle anytime before the selected modifier begins.

MODIFIERS

AUTO TEMP CONTROL

- EXTRA HOT / COLD ● EXTRA HIGH
 - HOT / COLD ● HIGH
 - WARM / WARM ● MEDIUM
 - WARM / COLD ● LOW ● HIGH
 - COLD / COLD ● EXTRA LOW ● LOW
 - TAP COLD / COLD ● NO SPIN ● OFF
-  WATER TEMP
WASH / RINSE
  SPIN SPEED
  END of CYCLE SIGNAL

- To change the water temperature, select the WATER TEMP button until the desired setting glows.
- To change the spin speed, select the SPIN SPEED button until the desired setting glows.

- HEAVY
 - NORMAL
 - LIGHT
-  SOIL LEVEL

- To change cycle time, select SOIL LEVEL button.
- To change the loudness of the End of Cycle Signal, select END of CYCLE SIGNAL.

Wash/Rinse Temp

Select a water temperature based on the type of load you are washing. Use the warmest water safe for fabrics. Follow garment label instructions.

Warm rinses leave the loads dryer than cold rinses. Warm rinses increase wrinkling. In cold climates, a warm rinse makes the load more comfortable to handle. Cold rinses save energy.

Temperature Guide

Wash Water Temperature	Suggested Fabrics
HOT 122°F (50°C) or above	Whites and pastels Heavy soils
WARM 104°F (40°C)	Bright colors Moderate to light soils
COLD 77°F (25°C)	Colors that bleed or fade Light soils

In wash water temperatures colder than 70°F (21°C), detergents do not dissolve well. Soils may be difficult to remove.

Auto Temp Control

ATC (Auto Temp Control) electronically senses and maintains a uniform water temperature. ATC regulates incoming hot and cold water. The ATC is automatically turned ON when a cycle is selected. (See “Preset Cycle Settings” in “Cycles.”)

- ATC ensures consistent cleaning.
- ATC works for the wash temperature with Extra Hot/Cold, Hot/Cold, Warm/Warm, Warm/Cold, and Cold/Cold settings.
- The Cold rinse temperatures depend on the cold water at your faucet.
- For the Tap Cold/Cold setting, both wash and rinse temperatures depend on the cold water at your faucet.
- The Warm rinse setting regulates the water temperature at approximately 104°F (40°C).

Laundry Guide

Refer to this chart for suggested load types and their corresponding cycles. Listed to the right are the options available to each of these washer cycles.

CYCLE	SUGGESTED LOAD TYPE	AVAILABLE OPTIONS				
		Prewash*	Stain Treat	Auto Soak*	2nd Rinse	Extended Spin
Sanitary	Heavily soiled underwear, towels, work clothes, diapers, etc.	✓	✓	✓	✓	✓
Whitest Whites	Heavily soiled white fabrics	✓	✓	✓	✓	✓
Heavy Duty	Normally soiled underwear, towels, shirts, etc., made of cotton	✓	✓	✓	✓	✓
Normal/Casual	Lightly to normally soiled blouses, shirts, overalls, etc., made of polyester, nylon, cotton, linen, or cotton blends	✓	✓	✓	✓	✓
Express Wash	Lightly to normally soiled overalls and sportswear made of cotton, polyester, nylon, and cotton blends			✓	✓	✓
Delicate	Curtains and delicate clothing, dresses, skirts, shirts and blouses	✓		✓	✓	
Silk	Fabrics made of silk identified as machine washable				✓	
Wool	Woolens with a felt-free finish, identified as machine washable				✓	
Ultra Handwash	Fabrics made of silk, special-care items marked "Handwashable"				✓	

* Prewash and Auto Soak cannot be selected at the same time.

ENGLISH

LAUNDRY TIPS

Preparing clothes for washing

Follow these recommendations to help you prolong the life of your garments.

- Close zippers, snaps, and hooks to avoid snagging other items. Remove pins, buckles, and other hard objects to avoid scratching the washer interior. Remove non-washable trim and ornaments.
- Empty pockets and turn them inside-out.
- Turn down cuffs; brush away lint and dirt.
- Turn synthetic knits inside-out to avoid pilling.
- Tie strings and sashes so they will not tangle.
- Mend tears, loose hems, and seams.
- Treat spots and stains.
- Stained or wet garments should be washed promptly for best results.

Sorting

- Separate heavily soiled items from lightly soiled ones, even if they would normally be washed together. Separate lint-givers (towels, chenille) from lint-takers (corduroy, synthetics, permanent press). When possible, turn lint-givers inside-out.

- Separate dark colors from light colors, colorfast items from non-colorfast items.
- Sort by fabric and construction (sturdy cottons, knits, delicate items).

Loading

Loading suggestions (maximum size loads).

Heavy Work Clothes

4 jeans	2 sweatpants
4 workpants	2 sweatshirts
4 workshirts	

Towels

10 bath towels	14 wash cloths
10 hand towels	

Mixed Load

3 sheets (1 king, 2 twin)	9 T-shirts
4 pillowcases	9 shorts
3 shirts	10 handkerchiefs
3 blouses	

WASHER CARE

Cleaning Your Washer

Cleaning the exterior

Use a soft damp cloth or sponge to wipe up any spills. Occasionally wipe the outside of your washer to keep it looking new. Use mild soap and water. Do not use abrasive products.

Cleaning the interior

Use a soft damp cloth or sponge to occasionally wipe the inner door to remove any detergent residue. Use mild soap and water. Do not use abrasive products.

Cleaning the door seal

Use a soft damp cloth or sponge when necessary. Check the fold of the seal periodically for any foreign objects.

Cleaning the dispenser drawer

The dispenser drawer is removable for easy cleaning.

1. Unlock the dispenser drawer by pressing the Release Lever in the Prewash compartment. See "Using the Dispenser." Remove the drawer.
2. Remove the inserts (the siphon from the softener and bleach compartments and the separator).
3. Wash the parts under running water.
4. Replace the inserts and return the dispenser to the drawer.

Water Inlet Hoses

Replace inlet hoses after five years of use to reduce the risk of hose failure. Periodically inspect and replace inlet hoses if bulges, kinks, cuts, wear or leaks are found.

When replacing your inlet hoses, record the date of replacement.

Vacation, Storage, and Moving Care

Install and store your washer where it will not freeze. Because some water may stay in the hoses, freezing can damage your washer. If storing or moving your washer during freezing weather, winterize it.

Non-use or vacation care:

Operate your washer only when you are at home. If you will be on vacation or not using your washer for an extended period of time, you should:

- Unplug washer or disconnect power.
- Turn off the water supply to the washer. This helps avoid accidental flooding (due to a water pressure surge) while you are away.
- Slightly open door to provide ventilation.

To winterize washer:

1. Put 1 quart (1 L) of R.V.-type antifreeze in the drum.
2. Run washer on a **DRAIN / SPIN** cycle.
3. Unplug washer or disconnect power.
4. Shut off both water faucets.
5. Disconnect water inlet hoses from faucets and drain.

To use washer again:

1. Flush water pipes.
2. Reconnect water inlet hoses to faucets.
3. Turn on both water faucets.
4. Plug in washer or reconnect power.
5. Run the washer through the **NORMAL/CASUAL** cycle with $\frac{1}{4}$ the normal recommended amount of detergent to clean out antifreeze.

To transport the washer:

1. If washer will be moved during freezing weather, put in a quart (1 L) of R.V.-type antifreeze in the drum. Run washer on a **DRAIN / SPIN** cycle.
2. Unplug the power cord.
3. Disconnect the drain hose from the drain system and attach to rear panel clips.
4. Shut off both water faucets.
5. Disconnect the water inlet hoses from faucets, then drain the hoses and clip them to the rear panel of the washer.
6. Do not reuse transport bolts. Unit must be transported in the upright position.

Re-installing the washer

1. Follow the "Installation Instructions" to locate, level and connect the washer.
2. Run the washer through the **NORMAL/CASUAL** cycle with $\frac{1}{4}$ the normal recommended amount of detergent to clean the washer and remove the antifreeze, if used.

TROUBLESHOOTING

First try the solutions suggested here to possibly avoid the cost of a service call...

Washer displaying code message and tone sounds

- **"HF" (Water Inlet Problem—no water or insufficient water supply)**

Select PAUSE/CANCEL twice to cancel the cycle. Unplug washer or disconnect power.

Check the following:

Are water faucets completely turned on?

Are screens at inlet hose connection to washer clogged?

Are water inlet hoses kinked?

Are water inlet hoses frozen?

Plug in washer or reconnect power. Re-select cycle and press START. If the problem remains, call for service.

- **"F02" (Drain Problem)**

Select PAUSE/CANCEL twice to cancel the cycle. Unplug washer or disconnect power.

Check the following:

Is the drain hose kinked?

Is the drain hose frozen?

Is the drain hose clogged?

Is the drain hose more than 96 in. (2.4 m) above the floor?

- **"SUD" (Suds Routine)**

When excessive suds are detected, a suds routine automatically starts. This routine removes extra suds and assures proper rinsing of your garments. "SUD" is displayed during rinsing and at the end of the cycle to inform you that Suds Routine was activated. To avoid excessive sudsing, reduce detergent amounts or use HE detergents.

- **"F" Variables [F4 to F16] (Electrical Problem)**

Select PAUSE/CANCEL twice to cancel the cycle. Select DRAIN/SPIN if there is excessive water in the washer.

Re-select cycle and press START. If the problem remains, call for service.

Washer won't start

- **Check the following:**

Is the power cord plugged into a grounded 3 prong outlet?

Is the washer door firmly shut?

Has a cycle been selected, but START has not been selected and held for one second?

Was the door open after completion of last cycle?

Washer won't fill, wash or rinse

- **Check the following:**

Is the power cord plugged into a grounded 3 prong outlet?

Is there power at the plug? Check electrical source or call electrician.

Are the hot and cold water faucets turned on?

Is the water inlet hose kinked?

Are the water inlet valve screens clogged?

Washer stops

- **Check the following:**

Is the power cord plugged into a grounded 3 prong outlet?

Is there power at the plug?

Check electrical source or call electrician.

Has a fuse blown or has the circuit breaker tripped?

If problem continues, call electrician.

Are you using an extension cord?

Do not use an extension cord.

Washer won't drain or spin

- **Is the drain hose clogged, or the end of the drain hose more than 96 in. (2.4 m) above the floor?**

- **Is your voltage low?**

Check electrical source or call electrician. Do not use an extension cord.

- **Is the "SUD" routine active?**

Cycle will complete once extra suds are removed.

Washer makes noise or vibrates

- **Is the washer level?**

The washer must be level. The four feet should be properly installed, and the nuts should be tightened against the washer cabinet.

As water is drained from the washer, you may hear air being pulled through the pump. This happens during the end of draining. It is normal.

- **Are you washing items with metal snaps, buckles or zippers?**

You may hear metal items touching the washer drum. This is normal.

- **Is washer installed on a sturdy and solid floor?**

Refer to the "Installation Instructions" for flooring requirements. Noise and vibration may be reduced by placing a piece of ¾ in. (19.1 mm) plywood underneath your washer. The plywood may extend underneath both washer and dryer to keep them at equal heights.

Washer leaks

- **Check household plumbing for leaks.**

Dispensers clogged or leaking

- **Are the laundry products in the correct dispenser compartment?**

Add the correct amounts of detergent, fabric softener or liquid chlorine bleach to the correct compartments. Add powdered or color-safe bleach to the Main Wash compartment.

- **Is the detergent separator in the correct position?**

Separator should be in the front position when using liquid detergent and in the back position when using powdered detergent.

Load too wet

- **Did you use the right cycle for the load being washed?**
Select a cycle with a higher spin speed.
- **Did you wash bulky items or have you overloaded the washer?**
Bulky items, or overloading may cause imbalance. First, try to evenly distribute your wet laundry in the drum, and start a DRAIN/SPIN cycle. If the laundry is still wet, take half of the load out of the washer and try again.

Residue or lint on load

- **Did you add detergent to the dispenser?**
For best results, add detergent to the detergent compartment. Do not add detergent to the washer drum.
- **Did you sort properly?**
Sort lint givers (towels, chenille) from lint takers (corduroy, synthetics). Also sort by color.
- **Did you overload the washer?**
Do not overload the washer. The washer can be fully loaded, but not tightly packed. The wash load must be balanced. Lint can be trapped in the load if overloaded.
- **Check the following:**
Was paper or tissue left in pockets?
- **Did you use enough detergent?**
Follow manufacturer's directions. Use enough detergent to hold the lint in the water.
- **Is your water colder than 70°F (21°C)?**
Wash water colder than 70°F (21°C) may not completely dissolve the detergent.
- **Are you using a low speed wash cycle?**
Powdered detergents may not dissolve well in a slow speed cycle. For best results, use liquid detergent for slow speed cycles like Delicate, Silk, Wool and Ultra Handwash.

Stains on load

- **Did you add detergent to the dispenser?**
For best results, add detergent to the detergent compartment. Do not add detergent to the washer drum.
- **Did you use enough detergent?**
Use enough detergent to remove soil and hold it in suspension. For best performance, use a High Efficiency detergent. Follow manufacturer's recommendations for the type of load you are washing.
- **Is there above average iron (rust) in water?**
You may need to install an iron filter.
- **Did you properly sort the load?**
Sort dark clothes from whites and lights.
- **Did you unload the washer promptly?**
To avoid dye transfer, unload the washer as soon as it stops.

- **Did you use a fabric softener dispensing ball?**
Dispensing balls will not operate correctly with this washer. Add liquid fabric softener to the fabric softener compartment.
- **Did you use powdered detergent in a low speed cycle?**
Consider using liquid detergent.
- **Did you use Express Wash on a large load?**
For best results, use Express Wash for small, lightly soiled loads.

Load is wrinkled

- **Did you unload the washer promptly?**
Unload the washer as soon as it stops.
- **Did you use the right cycle for the load being washed?**
Use the Delicate cycle or another cycle with a low spin speed to reduce wrinkling.
- **Did you overload the washer?**
The wash load must be balanced and not overloaded. Loads should tumble freely during washing.

Gray whites, dingy colors

- **Did you properly sort the load?**
Dye transfer can occur when mixing whites and colors in a load. Sort dark clothes from whites and lights.
- **Was the wash temperature too low?**
Use hot or warm washes if safe for the load. Hot water should be at least 120°F (49°C) to clean heavy soils.
- **Did you use enough detergent, or do you have hard water?**
Use more detergent for washing heavy soils in cold or hard water.

Cycle too long

- **Did you choose the Sanitary cycle or Stain Treat option?**
In both cases the heater will be activated to provide maximum cleaning performance. Additional time will be added to the regular cycle to heat the water. This additional time will depend on the load size and the hot water inlet temperature.
- **Is "SUD" shown in the display?**
Excessive sudsing has been detected and a suds routine has been started to destroy excessive suds. This routine will add time to the original cycle.

Door locked at end of wash cycle

- **Did all of the water drain out of the washer during the spin?**
Select DRAIN/SPIN to remove any water remaining in the washer. The washer door will unlock at the end of the drain.
- **Select DRAIN/SPIN to remove any water remaining in the washer.**
The washer door will unlock at the end of the drain.

Get it fixed, at your home or ours!

For repair of major brand appliances **in your own home...**
no matter who made it, no matter who sold it!

1-800-4-MY-HOME® Anytime, day or night
(1-800-469-4663) (U.S.A. and Canada)
www.sears.com www.sears.ca

For repair of carry-in products like vacuums, lawn equipment,
and electronics, call for the location of your nearest
Sears Parts and Repair Center.

1-800-488-1222 Anytime, day or night (U.S.A. only)
www.sears.com

For the replacement parts, accessories and owner's manuals
that you need to do-it-yourself, call **Sears PartsDirect™!**

1-800-366-PART 6 a.m. – 11 p.m. CST, 7 days a week
(1-800-366-7278) (U.S.A. only)
www.sears.com/partsdirect

To purchase or inquire about a Sears Service Agreement
or Sears Maintenance Agreement:

1-800-827-6655 (U.S.A.) **1-800-361-6665** (Canada)
7 a.m. – 5 p.m. CST, Mon. – Sat. 9 a.m. – 8 p.m. EST, M – F, 4 p.m. Sat.

Para pedir servicio de reparación a
domicilio, y para ordenar piezas:

1-888-SU-HOGAR™
(1-888-784-6427)

Au Canada pour service en français:

1-800-LE-FOYER™
(1-800-533-6937)
www.sears.ca



®Registered Trademark/TM Trademark of Sears, Roebuck and Co. under licensee by Sears Canada
As an ENERGY STAR® Partner, Sears, Roebuck and Co. has determined that this product
meets the ENERGY STAR® guidelines for energy efficiency

®Marca registrada/TM marca de comercio de Sears, Roebuck and Co., con licencia de Sears Canada
En su calidad de socio ENERGY STAR®, Sears, Roebuck and Co. ha determinado que este producto
cumple con las directrices ENERGY STAR® de rendimiento energético

® Marque déposée/TM Marque de commerce de Sears, Roebuck and Co. en vertu d'un porteur de licence par Sears Canada
À titre de partenaire ENERGY STAR®, Sears, Roebuck and Co. a déterminé que ce produit
satisfait aux directives d'efficacité énergétique ENERGY STAR®