

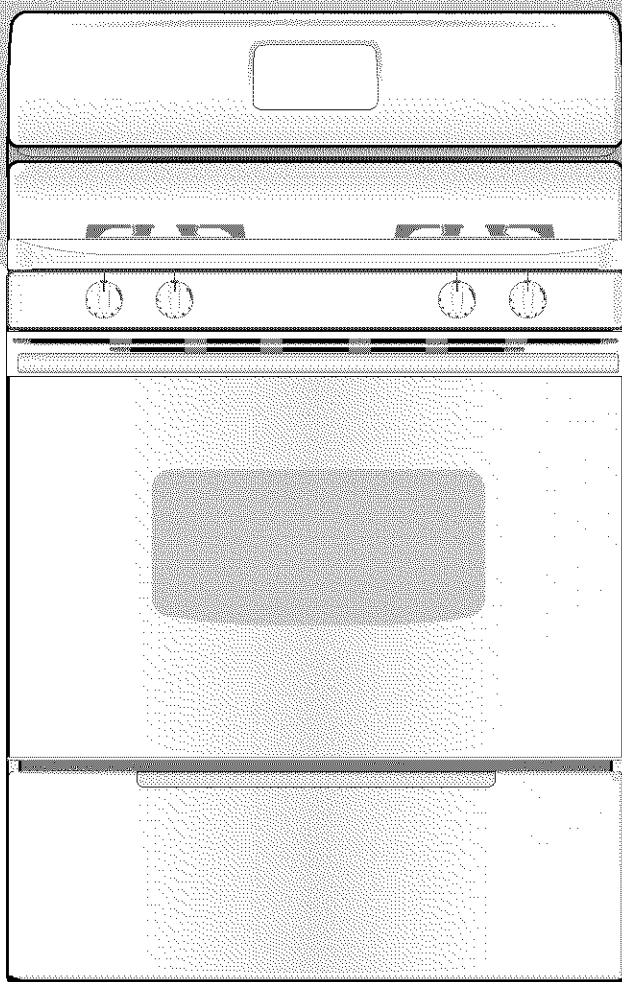









Use & Care Manual

Gas Range

*ES100 Control with Gas Sealed Burners
and Broiler Drawer*



Welcome	2	
Important Safety Instructions .	3-5	
Features at a Glance	6	
Setting Surface Controls	7	
Before Setting Oven Controls ..	8	
Oven Control Functions	8	
Setting Oven Controls	9-10	
Care & Cleaning	11-13	
Before You Call Solutions to Common Problems	14-15	
Warranty	Back Cover	

Visit the Frigidaire Web Site at:
<http://www.frigidaire.com>



Welcome & Congratulations

Questions?

1-800-944-9044

(United States)

1-866-729-5199

(Canada)

Please attach sales receipt
here for future reference.

Congratulations on your purchase of a new range! At **Electrolux Home Products**, we are very proud of our product and are completely committed to providing you with the best service possible. Your satisfaction is our number one priority.

We know you'll enjoy your new range and **Thank You** for choosing our product. We hope you consider us for future purchases.

PLEASE CAREFULLY READ AND SAVE THESE INSTRUCTIONS

This Use & Care Manual provides specific operating instructions for your model. Use your range only as instructed in this manual. These instructions are not meant to cover every possible condition and situation that may occur. Common sense and caution must be practiced when installing, operating and maintaining any appliance.

Please record your model and serial numbers below for future reference.

Model Number: _____

Serial Number: _____

Purchase Date: _____

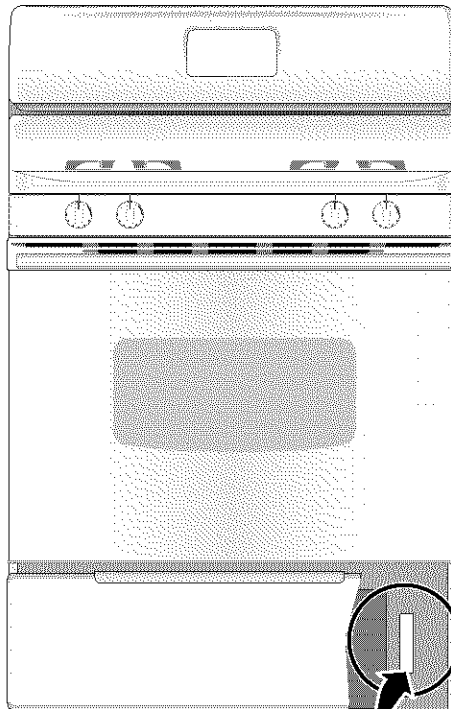

Serial plate location:
Open the broil drawer,
located on right side of range frame.

Product Registration

Register Your Product

The self-addressed **PRODUCT REGISTRATION CARD** should be filled in completely, signed and returned to Electrolux Home Products.

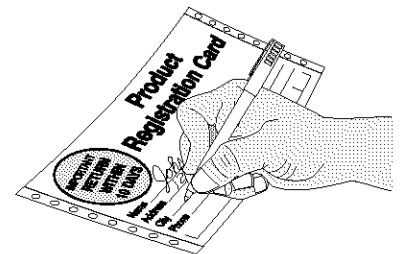

Important Safety Instructions



**Read all instructions before using this appliance.
Save these instructions for future reference.**

This manual contains important safety symbols and instructions. Please pay attention to these symbols and follow all instructions given.

⚠ WARNING This symbol will help alert you to situations that may cause serious bodily harm, death or property damage.

⚠ CAUTION This symbol will help alert you to situations that may cause bodily injury or property damage.

⚠ WARNING If the information in this manual is not followed exactly, a fire or explosion may result causing property damage, personal injury or death.

FOR YOUR SAFETY:

- Do not store or use gasoline or other flammable vapors and liquids in the vicinity of this or any other appliance.
 - **WHAT TO DO IF YOU SMELL GAS:**
 - Do not try to light any appliance.
 - Do not touch any electrical switch; do not use any phone in your building.
 - Immediately call your gas supplier from a neighbor's phone. Follow the gas supplier's instructions.
 - If you cannot reach your gas supplier, call the fire department.
 - Installation and service must be performed by a qualified installer, servicer or the gas supplier.
-
- **Remove all tape and packaging before using the range.** Destroy the carton and plastic bags after unpacking the range. Never allow children to play with packaging material.
 - **Proper Installation—Be sure your appliance is properly installed and grounded by a qualified technician in accordance with the National Fuel Gas Code ANSI Z223.- latest edition, or in Canada CAN/CGA B149.1, and CAN/CGA B149.2, and the the National Electrical Code ANSI/NFPA No.70-latest edition, or in Canada CSA Standard C22.1, Canadian Electrical Code, Part 1, and local code requirements.** Install only per installation instructions provided in the literature package for this range. Ask your dealer to recommend a qualified technician and an authorized repair service. Know how to disconnect the power to the range at the circuit breaker or fuse box in case of an emergency.
 - **User servicing—Do not repair or replace any part of the appliance unless specifically recommended in the manuals.** All other servicing should be done only by a qualified technician. This may reduce the risk of personal injury and damage to the range.
 - **Never modify or alter the construction of a range by removing leveling legs, panels, wire covers, anti-tip brackets/screws, or any other part of the product.**

⚠ WARNING

- All ranges can tip.
- Injury to persons could result.
- Install anti-tip device packed with range.
- See Installation Instructions.



⚠ WARNING To reduce the risk of tipping, the range must be secured by properly installed anti-tip bracket provided with the range. To check if the bracket is installed properly, visually check that rear leveling leg is inserted into and fully secured by the anti-tip bracket by removing lower panel or storage drawer. For models with a warmer drawer, grasp the top rear edge of the range and carefully attempt to tilt it forward. Refer to the installation instructions for proper anti-tip bracket installation.

⚠ WARNING Stepping, leaning or sitting on the doors or drawers of this range can result in serious injuries and also cause damage to the range. Do not allow children to climb or play around the range. The weight of a child on an open door may cause the range to tip, resulting in serious burns or other injury.

⚠ WARNING Do not use the oven or warmer drawer (if equipped) for storage.

⚠ CAUTION Do not store items of interest to children in the cabinets above a range or on the backguard of a range. Children climbing on the range to reach items could be seriously injured.

⚠ WARNING Never Use Your Appliance for Warming or Heating the Room.

- **Storage in or on Appliance—Flammable materials should not be stored in an oven, warmer drawer, near surface burners or in the storage drawer.** This includes paper, plastic and cloth items, such as cookbooks, plasticware and towels, as well as flammable liquids. Do not store explosives, such as aerosol cans, on or near the range.
- **Do Not Leave Children Alone—Children should not be left**



Important Safety Instructions

alone or unattended in the area where appliance is in use. They should never be allowed to sit or stand on any part of the appliance.

- **DO NOT TOUCH SURFACE BURNERS, AREAS NEAR THESE BURNERS, OVEN BURNERS OR INTERIOR SURFACES OF THE OVEN.** Both surface and oven burners may be hot even though flames are not visible. Areas near surface burners may become hot enough to cause burns. During and after use, do not touch, or let clothing or other flammable materials touch these areas until they have had sufficient time to cool. Among these areas are the cook top, surfaces facing the cook top, the oven vent openings and surfaces near these openings, oven door and window.
- **Wear Proper Apparel—Loose-fitting or hanging garments should never be worn while using the appliance.** Do not let clothing or other flammable materials contact hot surfaces.
- **Do Not Use Water or Flour on Grease Fires—Smother the fire with a pan lid, or use baking soda, a dry chemical or foam-type extinguisher.**
- **When heating fat or grease, watch it closely.** Fat or grease may catch fire if allowed to become too hot.
- **Use Only Dry Potholders—Moist or damp potholders on hot surfaces may result in burns from steam.** Do not let potholders touch hot heating burners. Do not use a towel or other bulky cloth instead of a potholder.
- **Do Not Heat Unopened Food Containers—Buildup of pressure may cause container to burst and result in injury.**
- **Remove the oven door from any unused range if it is to be stored or discarded.**

IMPORTANT—ELECTRIC IGNITION MODELS ONLY: Do not attempt to operate the oven during a power failure. If the power fails, always turn off the oven. If the oven is not turned off and the power resumes, the oven will begin to operate again. Once the power resumes, reset the clock and oven function.

IMPORTANT INSTRUCTIONS FOR USING YOUR COOKTOP

⚠ WARNING Use Proper Flame Size—Adjust flame size so it does not extend beyond the edge of the utensil. The use of undersized utensils will expose a portion of the burner flame to direct contact and may result in ignition of clothing. Proper relationship of utensil to flame will also improve efficiency.

- **Know which knob controls each surface burner.** Place a pan of food on the burner before turning it on, and turn the burner off before removing the pan.
- **Always turn knob to the full LITE position when igniting top burners.** Visually check that burner has lit. Then adjust the flame so it does not extend beyond the edge of the utensil.
- **Utensil Handles Should Be Turned Inward and Not Extend Over Adjacent Surface Burners—**To reduce the risk of burns, ignition of flammable materials, and spillage due to unintentional contact with the utensil, the handle of the utensil should be positioned so that it is turned inward, and does not extend over adjacent surface burners.
- **Never Leave Surface Burners Unattended at High Heat Settings—**Boilovers cause smoking and greasy spillovers that may ignite, or a pan that has boiled dry may melt.

- **Protective Liners—**Do not use aluminum foil to line surface burner pans, or oven bottom, except as suggested in this manual. Improper installation of these liners may result in risk of electric shock, or fire.
- **Glazed Cooking Utensils—**Only certain types of glass, glass/ceramic, ceramic, earthenware, or other glazed utensils are suitable for cooktop service without breaking due to the sudden change in temperature. Check the manufacturer's recommendations for cooktop use.

IMPORTANT INSTRUCTIONS FOR USING YOUR OVEN

- **Use Care When Opening Oven Door or Warmer Drawer—**Stand to the side of the range when opening the door of a hot oven. Let hot air or steam escape before you remove or replace food in the oven.
- **Keep Oven Vent Ducts Unobstructed.** The oven vent is located below the backguard. Touching the surfaces in this area when the oven is operating may cause severe burns. Also, do not place plastic or heat-sensitive items on or near the oven vent. These items could melt or ignite.
- **Placement of Oven Racks.** Always place oven racks in desired location while oven is cool. If rack must be moved while oven is hot use extreme caution. Use potholders and grasp the rack with both hands to reposition. Do not let potholders contact the hot heating elements in the oven. Remove all utensils from the rack before moving.
- **Do not use the broiler pan without its insert.** The broiler pan and its insert allow dripping fat to drain and be kept away from the high heat of the broiler.
- **Do not cover the broiler insert with aluminum foil. Exposed fat and grease could ignite.**
- Cold temperatures can damage the electronic control. When using the appliance for the first time, or when the appliance has not been used for an extended period of time, be certain the unit has been in temperatures above 32°F (0°C) for at least 3 hours before turning on the power to the appliance.

IMPORTANT INSTRUCTIONS FOR CLEANING YOUR RANGE

- **Clean the range regularly to keep all parts free of grease that could catch fire.** Pay particular attention to the area underneath each surface element. Do not allow grease to accumulate. Refer to the range manufacturer's instructions for cleaning.
- **Kitchen cleaners and aerosols—Always follow the manufacturer's recommended directions for use.** Be aware that excess residue from cleaners and aerosols may ignite causing damage and injury.

Important Safety Instructions



Grounding type
wall receptacle

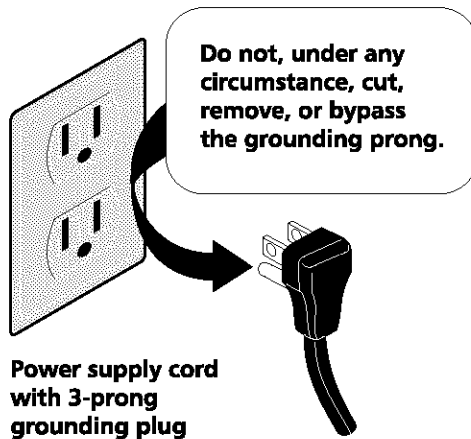

See the **INSTALLATION INSTRUCTIONS** packaged with this range for complete installation and grounding instructions.

GROUNDING INSTRUCTIONS

(electric ignition models only)

⚠ WARNING Avoid fire hazard or electrical shock. Do not use an adapter plug, an extension cord, or remove grounding prong from electrical power cord. Failure to follow this warning can cause serious injury, fire or death.

⚠ WARNING This appliance is equipped with a 3-prong grounding plug for your protection against shock hazard and should be plugged directly into a properly grounded receptacle. **DO NOT** cut or remove the grounding prong from this plug.

For personal safety, the range must be properly grounded. For maximum safety, the power cord must be plugged into an electrical outlet that is correctly polarized and properly grounded.

If a 2-prong wall receptacle is the only available outlet, it is the personal responsibility of the consumer to have it replaced with a properly grounded 3-prong wall receptacle installed by a qualified electrician.

IMPORTANT SAFETY NOTICE

The California Safe Drinking Water and Toxic Enforcement Act requires the Governor of California to publish a list of substances known to the state to cause cancer, birth defects or other reproductive harm, and requires businesses to warn customers of potential exposure to such substances.



Features At A Glance

Your Gas Range Features At a Glance

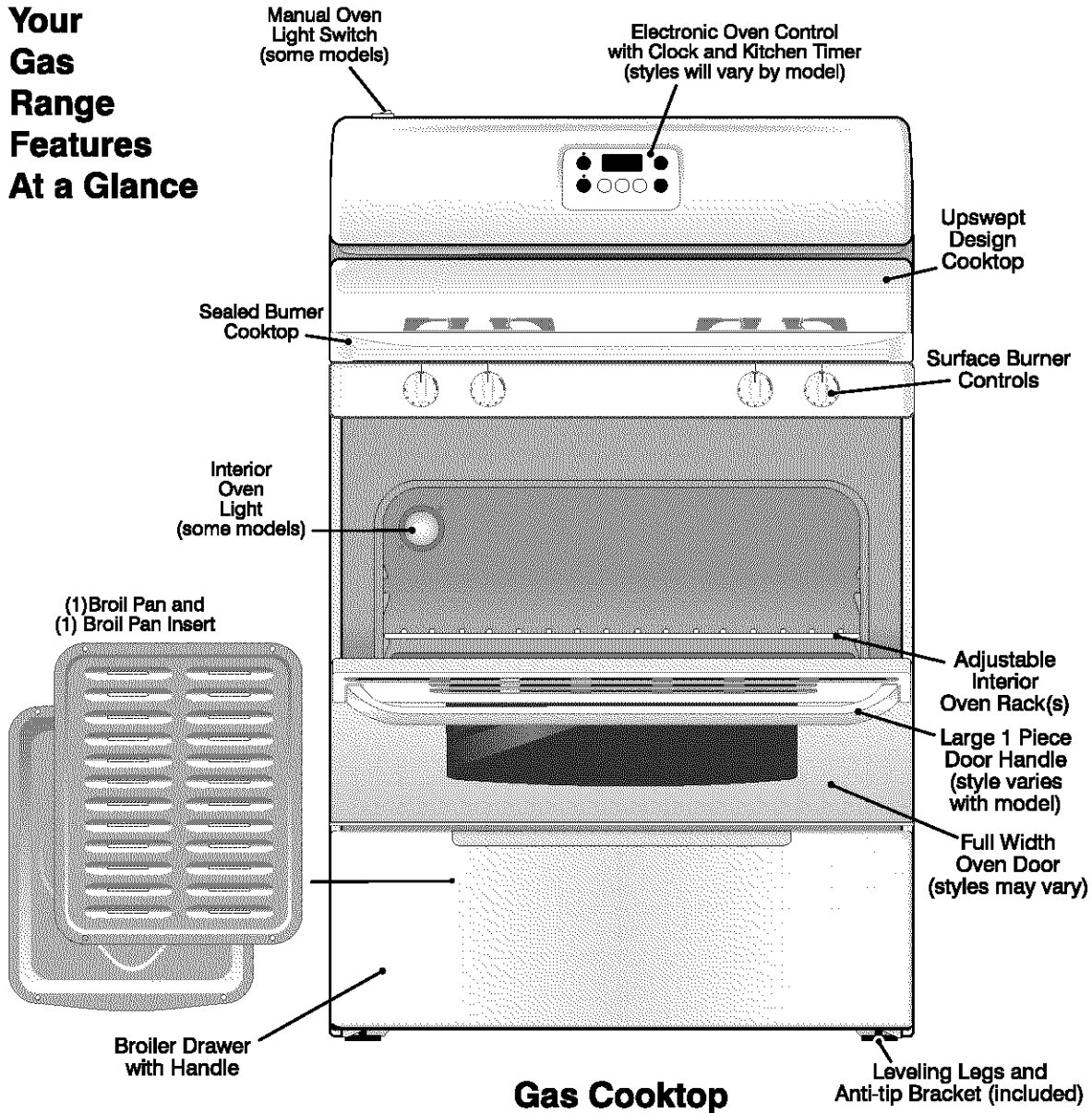

Gas Cooktop

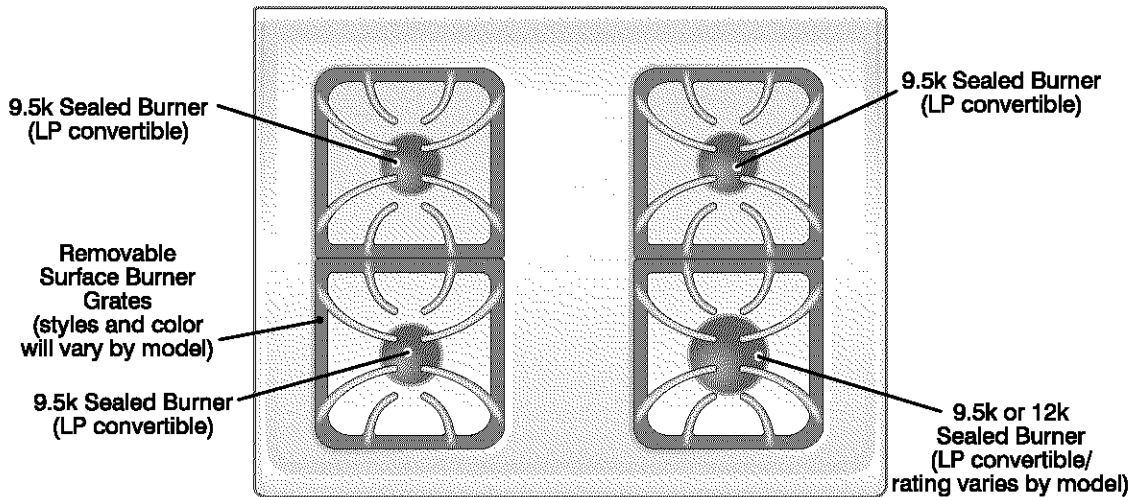

Features will vary according to model

Setting Surface Controls



CAUTION Do not place plastic items such as salt and pepper shakers, spoon holders or plastic wrappings on top of the range when it is in use. These items could melt or ignite. Potholders, towels or wood spoons could catch fire if placed too close to a flame.

In the event of an electrical power outage, the surface burners can be lit manually. To light a surface burner, hold a lit match to the burner head, then slowly turn the Surface Control knob to **LITE**. After burner lights push in and turn knob to desired setting. Use **CAUTION** when lighting surface burners manually.

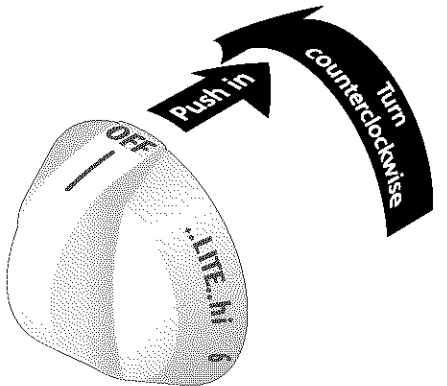

OFF ..LITE.. hi 6 5 4 3 2 lo

Setting Surface Controls

Your range may be equipped with different sized surface burners. The ability to heat food quicker and in larger volumes increases as the burner size increases.

The simmer burner (if equipped) is best used for simmering delicate sauces, etc.

The standard burners can be used for most surface cooking needs.

The **Power Plus™** burners (if equipped) are best used for bringing large quantities of liquid to temperature and when preparing larger quantities of food.

Regardless of size, always select cookware that is suitable for the amount and type of food being prepared. Select a burner and flame size appropriate to the pan. Never allow flames to extend beyond the outer edge of the pan.

Each burner lights automatically from an electric ignitor each time a control knob is turned to the **LITE** position.

Operating the Surface Burners

1. Place cooking utensil on surface burner.
2. Push the surface control knob in and turn **counterclockwise** out of the OFF position.
3. Release the knob and rotate to the LITE position. Note: All four electronic surface ignitors will spark at the same time. However, only the burner you are turning on will ignite.
3. Visually check that the burner has lit.
4. Push the control knob in and turn **counterclockwise** to the desired flame size. The control knobs do not have to be set at a particular setting. Use the guides and adjust the flame as needed. **DO NOT** cook with the surface control knob in the LITE position. (The electronic ignitor will continue to spark if the knob is left in the LITE position.)

Setting Proper Surface Burner Flame Size

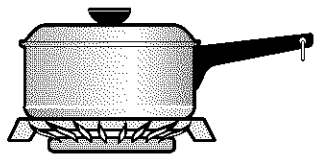

PROPER
FLAME
SIZE

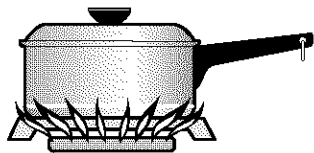

IMPROPER
FLAME
SIZE

Never extend the flame beyond the outer edge of the utensil. A higher flame simply wastes heat and energy, and increases your risk of being burned by the flame.

For most cooking, start on the highest control setting and then turn to a lower one to complete the process. Use the recommendations below as a guide for determining proper flame size for various types of cooking. The size and type of utensil used and the amount of food being cooked will influence the setting needed for cooking.

For deep fat frying, use a thermometer and adjust the surface control knob accordingly. If the fat is too cool, the food will absorb the fat and be greasy. If the fat is too hot, the food will brown so quickly that the center will be undercooked. Do not attempt to deep fat fry too much food at once as the food will neither brown nor cook properly.

*Flame Size

High Flame
Medium Flame
Low Flame

Type of Cooking

Start most foods; bring water to a boil; pan broiling.
Maintain a slow boil; thicken sauces, gravies; steaming.
Keep foods cooking; poach; stewing.

*These settings are based on using medium-weight metal or aluminum pans with lids. Settings may vary when using other types of pans. The color of the flame is the key to proper burner adjustment. A good flame is clear, blue and hardly visible in a well-lighted room. Each cone of flame should be steady and sharp. Adjust or clean burner if flame is yellow-orange.



Before Setting Oven Controls

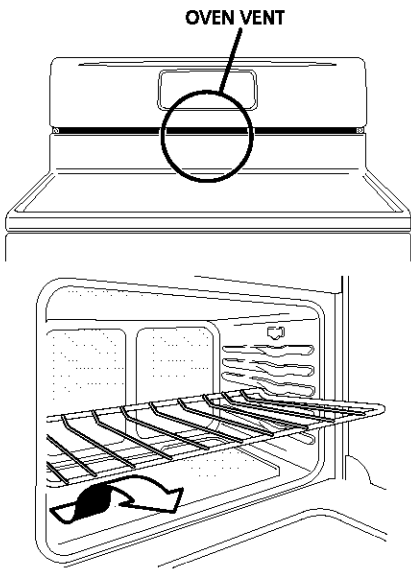

Oven Vent Location

The oven vent is located **below the backguard**. When the oven is on, warm air is released through this vent. This venting is necessary for proper air circulation in the oven and good baking results. **DO NOT BLOCK THE OVEN VENT.**

Arranging Oven Racks

ALWAYS ARRANGE OVEN RACKS WHEN THE OVEN IS COOL (PRIOR TO OPERATING THE OVEN). Always use oven mitts when using the oven.

Removing & Replacing Oven Racks

To remove, pull the rack forward until it stops. Lift up front of rack and slide out. **To replace**, fit the rack onto the guides on the oven walls. Tilt the front of the rack upward and slide the rack back into place.

Arranging Oven Racks with 6 Rack Positions

To bake on a single rack, place the rack on position 3 or 4. **To bake on 2 racks**, place the racks on positions 3 and 5.

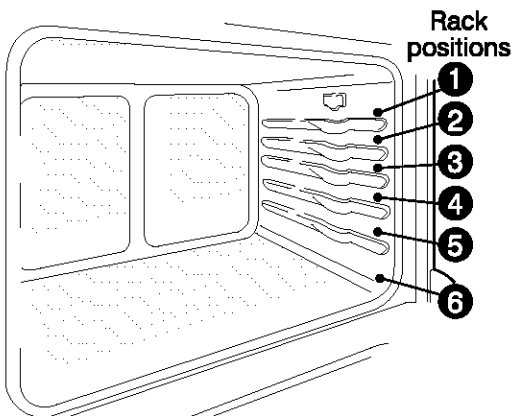

RECOMMENDED RACK POSITIONS FOR BROILING, BAKING & ROASTING

Food	Rack Position
Broiling meats, chicken or fish	1, 2 or 3
Cookies, cakes, pies, biscuits & muffins	3 or 4
Frozen pies, angel food cake, yeast, bread, casseroles, small cuts of meat or poultry	5
Turkey, roast or ham	5-6

Note: Always use caution when removing food from the lower rack positions.



Oven Control Functions

READ THE INSTRUCTIONS CAREFULLY BEFORE USING THE OVEN. For satisfactory use of your oven, become familiar with the various functions of the oven as described below.

BAKE PAD—Used to select the bake function.

BROIL PAD—Used to select the variable broil function.

TIMER ON/OFF PAD—Used to set or cancel the minute timer. The minute timer does not start or stop cooking.

CLOCK SET PAD—Used to set the time of day.

CLEAR/OFF—Used to clear any function previously entered except the time of day and minute timer. Press **CLEAR/OFF** to stop cooking.

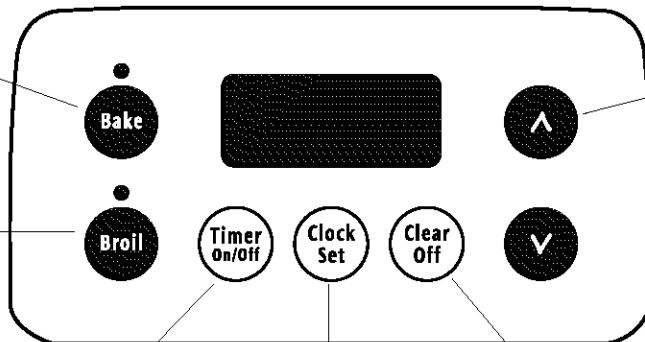

UP and DOWN ARROW PADS—Used along with the function pads to select oven temperature, time of day, clean time and minute timer.

Setting Oven Controls





Note: The time of day must first be set in order to operate the oven.

To Set the Clock

When the range is first plugged in, or when the power supply to the range has been interrupted, the display will flash "12:00".

1. Press .
2. Within 5 seconds, press and hold the  or  until the correct time of day appears in the display.

To Set the Minute Timer:



1. Press .
2. Press the  to increase the time in one minute increments. Press and hold the  to increase the time in 10 minute increments. The timer can be set for any amount of time from 1 minute to 11 hours and 59 minutes.

Note: If you press the  first, the timer will advance to 11 hours and 59 minutes.

3. The display shows the timer count down in minutes until one minute remains. Then the display will count down in seconds.
4. When the set time has run out, the timer will sound a 3 second beep. 0:00 will appear in the display until  is pressed.

Note: While the minute timer is counting down, the ":" will flash. The minute timer does not start or stop cooking. It serves as an extra timer in the kitchen that will beep when the set time has run out. The minute timer can be used alone or during any of the other oven functions. When the minute timer is in use with any other function, the minute timer will be shown in the display. To view other functions, press the pad for that function.

To Change the Minute Timer while it is in use:









While the timer is active and shows in the display, press and hold the  or  to increase or decrease the time.

To Cancel the Minute Timer before the set time has run out: Press .



To Set or Change the Temperature for Baking

The oven can be programmed to bake at any temperature from 170°F to 500°F.

To Set the Controls for Baking:

1. Press . "— — —°" appears in the display.
2. Within 5 seconds, press the  or . The display will show "350°F." By pressing and holding the  or , the temperature can then be adjusted in 5°F increments.
3. When the  or  is released, the oven will begin heating to the selected temperature. When the displayed temperature reaches the desired baking temperature, the control will beep once (1 time).
4. To cancel the baking function, press .

To Change the Oven Temperature after Baking has Started:

1. Press  and make sure the bake temperature is displayed.
2. Press the  or  to increase or decrease the set temperature.



Setting Oven Controls

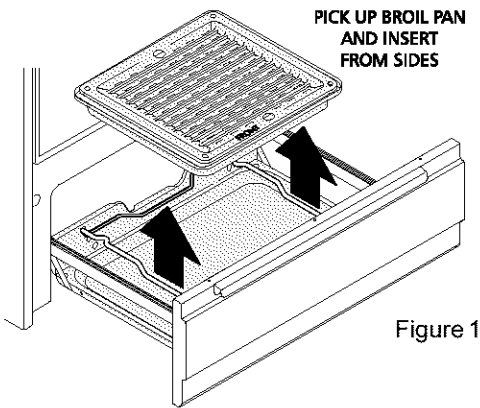

Figure 1

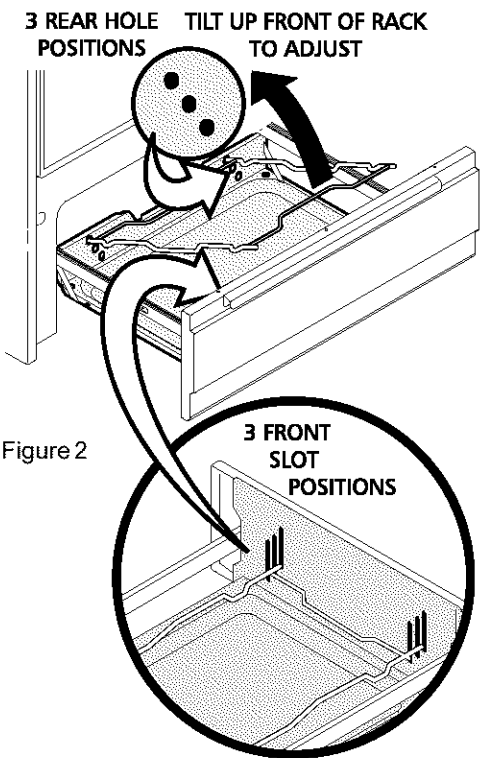
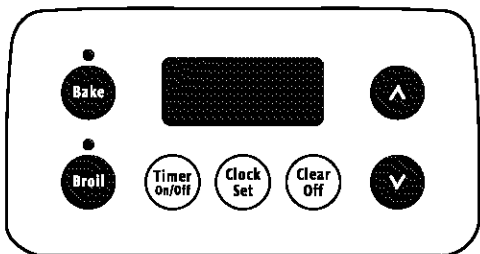

Figure 2



To Broil

1. Slide broiler drawer out to the stop position.
2. Remove broiler pan and insert (See Figure 1).
3. Always position rack before setting control, while range is cool.
4. Position rack by tilting front of rack up and pulling rack out from locating holes in rear of broiler drawer. Reposition back of rack in the desired locating holes and allow front of rack to slide down into the corresponding slots in front of broiler drawer (See Figure 2).

For rare meats, position the rack closer to the burner (upper position).

For medium foods use middle position.

For well-done foods such as chicken, lobster tails or thick cuts of meat, position the rack further from the burner (lower position).

5. Place insert on broiler pan, then place meat on insert. **DO NOT** use the broiler pan without the insert. **DO NOT** cover the insert with aluminum foil. The exposed fat could ignite.
6. Place broiler pan on rack; make sure the broiler pan with the insert is positioned as shown (See Figure 1). Be sure front of pan is positioned correctly in rack.
7. Slide the broiler drawer all the way into the range. Press **Broil** on Oven Control.
8. Press and hold the **▲** or **▼** until the desired broil setting level appears in the display. Press the **▲** for **HI** (high) broil or the **▼** for **LO** (low) broil. Most foods can be broiled at the **HI** broil setting. Select the **LO** broil setting to avoid excess browning or drying of foods that should be broiled to the well-done stage.
9. Broil on one side until food is browned; turn and cook on the second side. **Note:** Always pull the rack out to the stop position before turning or removing food.
10. When broiling is finished, press **Clear Off**.
11. When removing broiler pan from broiler drawer always use pot holders.

Note: The broiler pan and the insert allows grease to drain and be kept away from the high heat of the broiler (see illustration). **DO NOT** use the pan without the insert. **DO NOT** cover the insert with foil; the exposed grease could ignite.

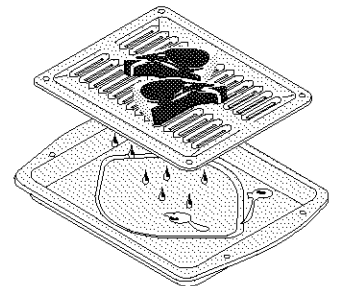

WARNING **DO NOT** use the broiler drawer for storage. Items placed in the broiler drawer will catch fire.

CAUTION Should an oven fire occur, close the oven door and turn off the oven. If the fire continues, use a fire extinguisher. **DO NOT** put water or flour on the fire. Flour may be explosive.

Care & Cleaning

(Cleaning Chart)



Surfaces

How to Clean

Aluminum (Trim Pieces) & Vinyl

Use hot, soapy water and a cloth. Dry with a clean cloth.

Glass, Painted and Plastic Body Parts, Control Knobs and Decorative Trim Pieces

For general cleaning, use hot, soapy water and a cloth. For more difficult soils and built-up grease, apply a liquid detergent directly onto the soil. Leave on soil for 30 to 60 minutes. Rinse with a damp cloth and dry. **DO NOT** use abrasive cleaners on any of these materials; they can scratch.

Painted Control Panels

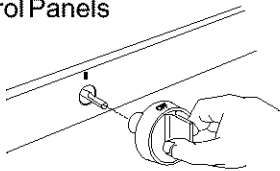

Before cleaning the control panel, turn all controls to OFF and remove the control knobs. To remove, pull each knob straight off the shaft. Clean as instructed above. Squeeze excess water from the cloth before wiping the panel; especially when wiping around the controls. Excess water in or around the controls may cause damage to the appliance. To replace knobs after cleaning, line up the flat sides of both the knob and the shaft, then push the knob(s) into place.

Porcelain Enamel Burner Grates, Cooktop Surface, Below Cooktop, Broiler Pan & Insert, Broiler Drawer, Door Liner, Oven Bottom and Burner Drip Pans

Clean burner grates, broiler pan and insert in the dishwasher and dry upon removal. If soils are not removed, follow the cooktop cleaning instructions below.

Gentle scouring with a soapy scouring pad will remove most spots. Rinse with a 1:1 solution of clean water and ammonia. *If necessary*, cover difficult spots with an ammonia-soaked paper towel for 30 to 40 minutes. Rinse with clean water and a damp cloth, then scrub with a soap-filled scouring pad. Rinse and wipe dry with a clean cloth. Remove all cleaners or the porcelain may become damaged during future heating. **DO NOT** use spray oven cleaners on the range top.

Oven Racks

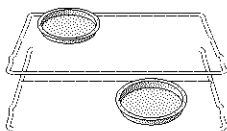

Remove racks. See "Removing and Replacing Oven Racks" under **Before Setting Oven Controls**. Use a mild, abrasive cleaner, following manufacturer's instructions. Rinse with clean water and dry. After cleaning the racks, rub the sides of the racks with wax paper or a cloth containing a small amount of baby oil or salad oil (this will make the racks glide easier into the rack positions).

Oven Door

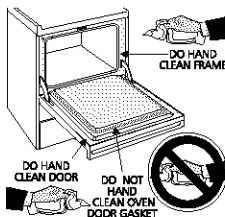

To clean oven door, wash with hot, soapy water and a clean cloth. **DO NOT** immerse the door in water.

DO NOT clean the oven door gasket. The oven door gasket is made of a silicone rubber material, which is essential for a good seal. Care should be taken not to rub, damage or remove the gasket.

Stainless Steel (some models)

Clean **stainless steel** with hot, soapy water and a dishcloth. Rinse with clean water and a cloth. **Do not use cleaners with high concentrations of chlorides or chlorines**. Do not use harsh scrubbing cleaners. Only use kitchen cleaners that are especially made for cleaning stainless steel. Always be sure to rinse the cleaners from the surface as bluish stains may occur during heating that cannot be removed.



Care & Cleaning

Care and Cleaning of Stainless Steel (some models)

Some models are equipped with stainless steel exterior parts. Special care and cleaning are **required** for maintaining the appearance of stainless parts. Please refer to the Cleaning Chart provided at the beginning of the **Care & Cleaning** section in this Use & Care Manual.

Cleaning the Cooktop

The cooktop is designed to make cleaning easier. Because the four burners are sealed, cleanups are easy when spills are cleaned up immediately.

To clean, wipe with a clean, damp cloth and wipe dry.

Cleaning the Contoured Well Areas, Burner Caps, Burner Heads and Burner Drip Pans

The contoured well areas, burner caps, burner heads and burner drip pans (some models) should be routinely cleaned. Keeping the burner ports clean will prevent improper ignition and an uneven flame. Refer to the following section for instructions.

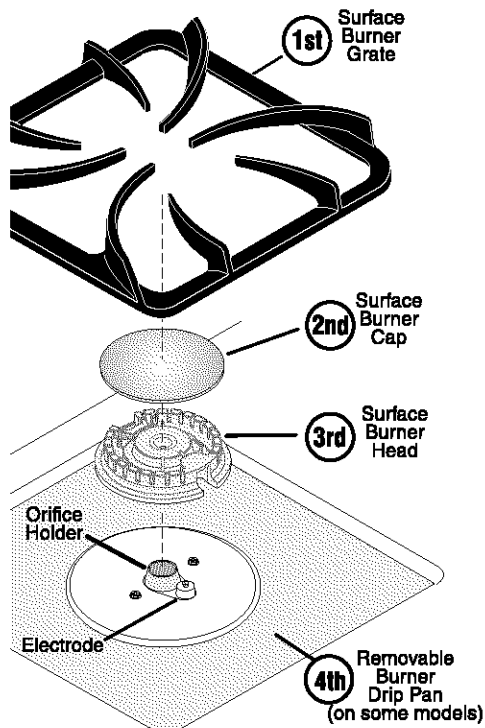

To Clean the Recessed and Contoured Areas of the Cooktop - If a spill occurs on or in the recessed or contoured areas, blot up spill with an absorbent cloth. Rinse with a clean, damp cloth and wipe dry.

To Remove and Replace the Surface Burner Caps and Surface Burner Heads - Remove in the following order: (1st) surface burner grate, (2nd) surface burner cap, (3rd) surface burner head and (4th) surface burner drip pan (if equipped).

Reverse the procedure above to replace the surface burner cap, surface burner head and surface burner drip pans (if equipped). **Do not remove any parts from the cooktop until they have completely cooled and are safe to handle. Do not operate the surface burners without the surface burner cap and surface burner head properly in place.**

To Clean the Surface Burner Cap, Surface Burner Head and Surface Burner Drip Pan (if equipped) - Use a soap-filled scouring pad or a mild abrasive cleanser to clean the surface burner caps, surface burner heads and surface burner drip pans (if equipped). The ports (or slots) around the burner head must be routinely cleaned. If residue still remains in these ports, use a small-gauge wire or needle to clean the slots or holes. For proper flow of gas and ignition of the burner—**DO NOT ALLOW SPILLS, FOOD, CLEANING AGENTS OR ANY OTHER MATERIAL TO ENTER THE GAS ORIFICE HOLDER OPENING. ALWAYS** keep the surface burner cap and surface burner head in place whenever a surface burner is in use.

THE COOKTOP IS NOT REMOVABLE. Do not attempt to remove or lift the cooktop.

CAUTION Use caution when replacing the burner cap so the electrode is not damaged. This may cause a delayed ignition or prevent the burner from igniting.

CAUTION Any additions, changes or conversions required in order for this appliance to satisfactorily meet the application needs must be made by an authorized **Frigidaire** Distributor or Qualified Agency.

Care & Cleaning

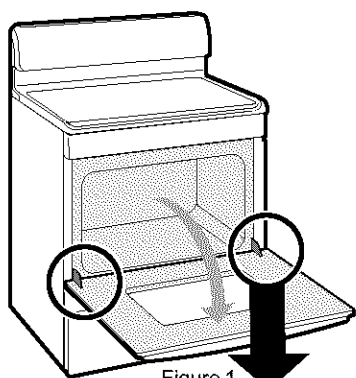

Figure 1

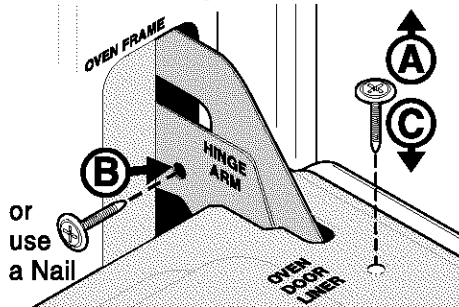

Figure 2

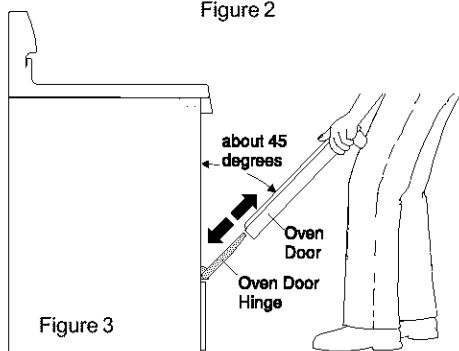
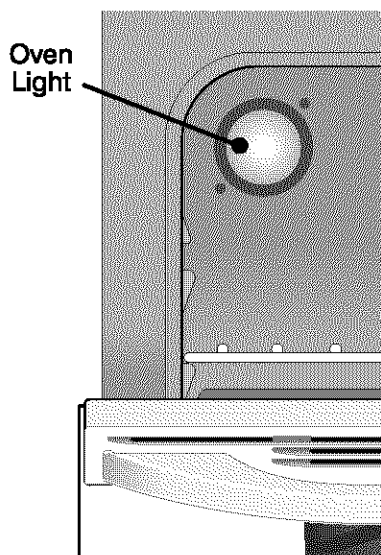

Figure 3



Removing and Replacing the Oven Door (all models)

CAUTION The door is heavy. For safe, temporary storage, lay the door flat with the inside of the door facing down.

To Remove Oven Door:

1. Open oven door completely (horizontal with floor - See Fig. 1).
2. Remove 2 screws located on the inside of the oven door liner (See **A** Fig. 2).
3. Insert the 2 screws into the door hinge holes located on the side of the hinge arm, one into each hinge (See **B** Fig. 2).
4. Close oven door until the door stops, (Do not force the door to close any further). The placement of these screws should keep door open in about a 45 degree position.
5. Grasp oven door firmly on both sides and slide door up and off hinges at the same angle. (See Fig. 3)
6. To clean oven door, follow the instructions provided in the Cleaning Chart at the beginning of the **Care & Cleaning** section (See Door Liner).

To Replace Oven Door:

1. Be sure the hinge arms remain at the 45 degree angle position. Be sure the screws are still locking the hinge arms from moving. If the screws fall out of the hinge holes, the hinge(s) may snap back against the oven frame and could pinch fingers or chip the porcelain finish on the oven front frame.
2. Hold door at the sides near the top while resting the lower front of door on your knee. Insert the door channels at the bottom of door over the door hinges, (See Fig. 3).
3. Allow the door to slide down into the door hinges evenly at the same 45 degree angle. The hinge arms should be inserted into the bottom corners as far as they can go.
4. Open door completely (horizontal with floor) and remove both screws from holes in door hinges.
5. Reinstall the 2 screws into the door liner (See **C** Fig. 2).
6. If the door is not in alignment with the oven frame, remove door and repeat the above steps.

Changing the Oven Light (some models)

On some models, the oven light automatically turns on when the door is opened. Some models have a switch located on the control panel to turn on the light. The oven light is located at the rear of the oven.

To replace the oven light:

1. Turn electrical power off at the main source or unplug the range.
2. Replace bulb with a new 40 watt appliance bulb.
3. Turn power back on again at the main source (or plug the range back in).
4. The clock will then need to be reset. To reset, see "Setting the Clock" and "Setting the Minute Timer" under **Setting Oven Controls** in this Use & Care Manual.

CAUTION Be sure the range is unplugged and all parts are COOL before replacing oven light. Wear a leather-faced glove for protection against possible broken glass.



Before You Call

Solutions to Common Problems

Before you call for service, review this list. It may save you time and expense. The list includes common occurrences that are not the result of defective workmanship or materials in this appliance.

OCCURRENCE	POSSIBLE CAUSE / SOLUTION
Range is not level.	<p>Poor installation. Place oven rack in center of oven. Place a level on the oven rack. Adjust leveling legs at base of range until the rack is level. When range is level, cooktop may appear out of alignment if countertop is not level.</p> <p>Weak, unstable floor. Be sure floor is level and can adequately support range. Contact a carpenter to correct sagging or sloping floor.</p> <p>Kitchen cabinet misalignment may make range appear to be unlevel. Be sure cabinets are square and have sufficient room for range clearance.</p>
Cannot move appliance easily. Appliance must be accessible for service.	<p>Cabinets not square or are built in too tight. Contact a cabinet maker to correct the problem.</p> <p>Contact builder or installer to make appliance accessible.</p> <p>Carpeting interferes with range. Provide sufficient space so range can be lifted over carpet.</p> <p>Gas line is hard-plumbed. Have a flexible C.S.A. International approved metal appliance connector installed.</p>
Surface burners do not light.	<p>Surface Control knob has not been completely turned to LITE. Push in and turn the Surface Control knob to LITE until burner ignites and then turn control knob to desired flame size.</p> <p>Burner ports are clogged. With the burner off, use a small-gauge wire or needle to clean ports. See "Surface Burners" in the cleaning table under Care & Cleaning for additional cleaning instructions.</p> <p>Range power cord is disconnected from outlet (electric ignition models only). Be sure cord is securely plugged into the outlet.</p> <p>Electrical power outage (electric ignition models only). Burners can be lit manually. See Setting Surface Controls in this Use & Care Manual.</p>
Surface burner flame burns half way around.	<p>Burner ports are clogged. With the burner off, clean ports by using a small-gauge wire or needle.</p> <p>Moisture is present after cleaning. Lightly fan the flame and allow burner to operate until flame is full. Dry the burners thoroughly following instructions in the Care & Cleaning section.</p>
Surface burner flame is orange.	<p>Dust particles in main line. Allow the burner to operate a few minutes until flame turns blue.</p> <p>In coastal areas, a slightly orange flame is unavoidable due to salt air.</p>
Oven does not operate.	<p>Be sure the oven controls are set correctly for the desired function. See Setting Oven Controls in this Owner's Manual or Entire Appliance Does Not Operate (see below).</p> <p>Be sure regulator gas valve is "ON". See installation instructions.</p>
Entire appliance does not operate.	<p>The time of day must first be set in order to operate the oven.</p> <p>Make sure electrical cord/plug is plugged tightly into outlet (electric ignition models only).</p> <p>Service wiring not complete. Contact servicer or dealer.</p> <p>Electrical power outage (electric ignition models only). Check house lights to be sure. Call your local electric company for service. Surface burners can be lit manually. See Setting Surface Controls in this Use & Care Manual.</p> <p>Be sure gas supply is turned on.</p>
Oven light does not work (some models).	<p>Burned-out or loose bulb. See Changing the Oven Light (some models) section in this Use & Care Manual to replace or tighten the bulb.</p>

Before You Call

Solutions to Common Problems (cont'd)



OCCURRENCE	POSSIBLE CAUSE / SOLUTION
Oven smokes excessively during broiling.	<p>Meat too close to the broil burner. Reposition the rack to provide more clearance between the meat and the broiler.</p> <p>Meat not properly prepared. Remove excess fat from meat. Slash remaining fatty edges to prevent curling, but do not cut into the lean.</p> <p>Broiler pan used without insert or insert covered with foil. DO NOT use the broiler pan without the insert or cover the insert with foil.</p> <p>Broiler drawer needs to be cleaned. Excessive smoking is caused by a build up of grease or food spatters. If the broiler is used often, clean on a regular basis.</p> <p>Broiler drawer is open. Drawer/door should be closed when broiling.</p>
Oven Control Errors	<p>This oven is equipped with a state of the art electronic oven controller. Among its many features is a full time oven circuit diagnostics system. The controller constantly monitors its internal circuitry as well as several crucial oven circuits to insure they are all operating correctly. If at any time one of these systems fails, the controller will immediately stop operation, and beep continuously (flashing an error code of F1 or F3* in the display window, if equipped).</p>
*Oven control beeps and displays F1 or F3.	<p>Electronic control has detected a fault condition. Press CLEAR/OFF to clear the display and stop beeping. Reprogram oven. If fault recurs, record fault number. Press CLEAR/OFF and contact an authorized servicer.</p>
Poor baking results.	<p>Many factors affect baking results. Make sure the proper rack position is used. Center food in the oven and space pans to allow air to circulate. Allow the oven to preheat to the set temperature before placing food in the oven. Try adjusting the recipe's recommended temperature or baking time.</p>
Soil is not completely removed.	<p>Failure to clean bottom front, top of oven or door areas outside oven seal. Clean these areas. Burned-on residue may be cleaned with a stiff nylon brush and water or a nylon scrubber. Be careful not to damage the oven gasket.</p> <p>Excessive spillovers in oven. Set self-clean cycle for a longer cleaning time.</p>
Flames inside oven or smoking from oven vent.	<p>Excessive spillovers in oven. This is normal, especially for pie spillovers or large amounts of grease on the oven bottom. Wipe up excessive spillovers. If flames or excessive smoke are present, see "Broil" in the Setting Oven Controls section.</p>



RANGE WARRANTY

Your range is protected by this warranty

	WARRANTY PERIOD	THROUGH OUR AUTHORIZED SERVICERS, WE WILL:	THE CONSUMER WILL BE RESPONSIBLE FOR:
FULL ONE-YEAR WARRANTY	One year from original purchase date.	Pay all costs for repairing or replacing any parts of this appliance which prove to be defective in materials or workmanship.	Costs of service calls that are listed under NORMAL RESPONSIBILITIES OF THE CONSUMER.*
LIMITED 2ND-5TH YEAR WARRANTY (Glass Smoothtop, Seal & Elements)	Second through fifth years from original purchase date.	Provide a replacement for any defective surface heating element, deteriorated rubberized-silicone seal (upwept models only), or glass smoothtop that cracks due to thermal breakage (not customer abuse).	Diagnostic costs and any transportation and labor costs which are required because of service.
LIMITED WARRANTY (Applicable to the State of Alaska)	Time periods listed above.	All of the provisions of the full and limited warranties above and the exclusions listed below apply.	Costs of the technician's travel to the home and any costs for pick up and delivery of the appliance required because of service.

In the U.S.A., your appliance is warranted by Electrolux Home Products North America, a division of White Consolidated Industries, Inc. We authorize no person to change or add to any of our obligations under this warranty. Our obligations for service and parts under this warranty must be performed by us or an authorized Electrolux Home Products North America servicer. In Canada, your appliance is warranted by WCI Canada, Inc.

*NORMAL RESPONSIBILITIES OF THE CONSUMER

This warranty applies only to products in ordinary household use, and the consumer is responsible for the items listed below:

1. Proper use of the appliance in accordance with instructions provided with the product.
2. Proper installation by an authorized servicer in accordance with instructions provided with the appliance and in accordance with all local plumbing, electrical and/or gas codes.
3. Proper connection to a grounded power supply of sufficient voltage, replacement of blown fuses, repair of loose connections or defects in house wiring.
4. Expenses for making the appliance accessible for servicing, such as removal of trim, cupboards, shelves, etc., which are not a part of the appliance when it was shipped from the factory.
5. Damages to finish after installation.
6. Replacement of light bulbs and/or fluorescent tubes (on models with these features).

EXCLUSIONS

This warranty does not cover the following:

1. CONSEQUENTIAL OR INCIDENTAL DAMAGES SUCH AS PROPERTY DAMAGE AND INCIDENTAL EXPENSES RESULTING FROM ANY BREACH OF THIS WRITTEN OR ANY IMPLIED WARRANTY.
NOTE: Some states do not allow the exclusion or limitation of incidental or consequential damages, so this limitation or exclusion may not apply to you.
2. Service calls which do not involve malfunction or defects in workmanship or material, or for appliances not in ordinary household use. The consumer shall pay for such service calls.
3. Damages caused by services performed by servicers other than Electrolux Home Products North America or its authorized servicers; use of parts other than genuine Electrolux Home Products parts; obtained from persons other than such servicers; or external causes such as abuse, misuse, inadequate power supply or acts of God.
4. Products with original serial numbers that have been removed or altered and cannot be readily determined.

IF YOU NEED SERVICE

Keep your bill of sale, delivery slip, or some other appropriate payment record. The date on the bill establishes the warranty period should service be required. If service is performed, it is in your best interest to obtain and keep all receipts. This written warranty gives you specific legal rights. You may also have other rights that vary from state to state. Service under this warranty must be obtained by contacting Electrolux Home Products:

This warranty only applies in the 50 states of the U.S.A., Puerto Rico, and Canada. Product features or specifications as described or illustrated are subject to change without notice. All warranties are made by Electrolux Home Products North America, a division of White Consolidated Industries, Inc. In Canada, your appliance is warranted by WCI Canada, Inc.

03-U-RA-01 (rev. 01/2001)

USA

800-944-9044

Electrolux Home Products North America
P.O. Box 212378
Augusta, GA 30917

Canada

866-213-9397 (English)

866-294-9911 (French)

Electrolux Home Products North America
6150 McLaughlin Road
Mississauga, Ontario, Canada
L5R 4C2