

COLORS/CODIGOS/COULEUR

- BK. - BLACK/NEGRO/NOIR
- G. - GREEN/VERDE/VERT
- W. - WHITE/BLANCO/BLANC
- R. - RED/ROJO/ROUGE
- O. - ORANGE/NARANJA/ORANGE
- Y. - YELLOW/AMARILLO/JAUNE
- BR. - BROWN/MORENO/BRUN
- BL. - BLUE/AZUL/BLEU

CODE	GAUGE CODIGO CODE	MEDIDA CALIBRE	TEMP. °C	CSA	UL
1	18		125	CL1251	3173
2	16		125	CL1251	3173
3	14		125	CL1251	3173
4	12		125	CL1251	3173
5	18		150	EXL-150	3321
6	16		150	EXL-150	3321
7	14		150	EXL-150	3321
8	12		150	EXL-150	3321
9	10		150	EXL-150	3321
10	18		200	SEW-1	3122
11	16		200	SEW-1	3122
12	12		250		3252
13	16		250		3252
14	20		150	EXL-150	3321
15	8		150	EXL-150	3321
16	8		60		
17	10		60		
18	10		200	SEW-1	3122
19	20		125	CL1251	3173
20	20		200	SEW-1	3122
21	22		125	CL1252	3266
22	22		150		10109

SW. A
LATCH MOTOR
MOTOR DE CERROJO
MOTEUR VERROU

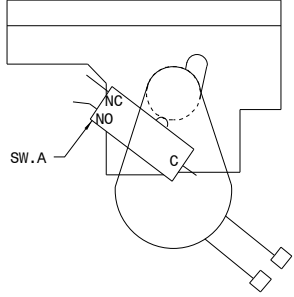

CONNECTOR
CONECTOR
CONNECTEUR
A

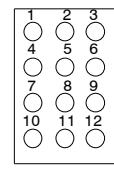

CONNECTOR
CONECTOR
CONNECTEUR
B

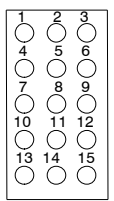

CAUTION: DISCONNECT CURRENT BEFORE REMOVING REAR COVER.
ATENCIÓN: CORTAR EL CORRIENTE ANTES DE REALIZAR EL MANTENIMIENTO DEL ELECTRODOMESTICO.
ATTENTION: COUPEZ L'ALIMENTATION AVANT D'EFFETUER LA REPARATION.

**SURFACE-ELEMENT-CIRCUIT/CIRCUITO DE ELEMENTO DE SUPERFICIE/
CIRCUIT DES ELEMENTS DE SURFACE
GLASS COOKTOP/CUBIERTA DE VIDRIO/TABLE DE CUISSON VITRIFIEE**

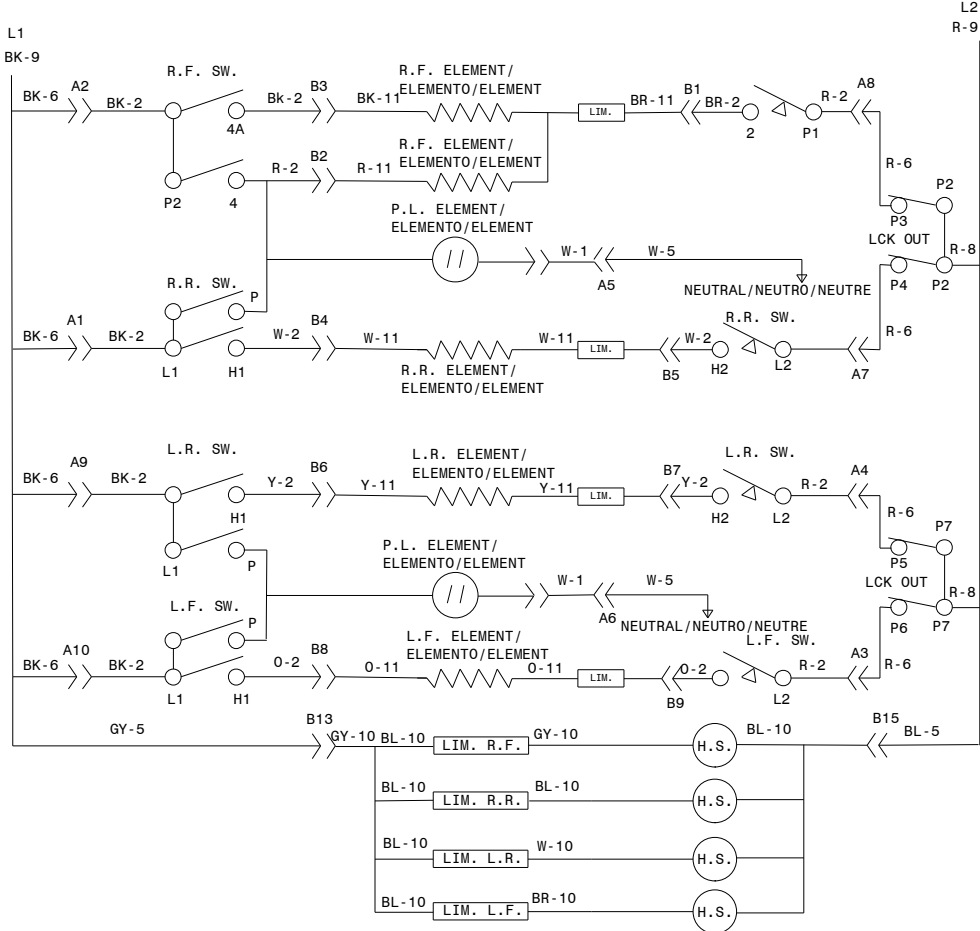

LEGEND/LEYENDA/LEGENDE

- SW. - SWITCH/INTERRUPTOR/INTERRUPTEUR
- R.F. - RIGHT FRONT/FRENTE DERECHO/AVANT DROIT
- R.R. - RIGHT REAR/TRASERO DERECHO/ARRIERE DROIT
- L.F. - LEFT FRONT/FRENTE IZQUIERDO/AVANT GAUCHE
- L.R. - LEFT REAR/TRASERO IZQUIERDO/ARRIERE GAUCHE
- LIM. - LIMITOR/LIMITADOR/LIMITEUR
- H.S. - HOT SURFACE/SUPERFICIE CALIENTE/SURFACE CHAUDE
- P.L. - PILOT LIGHT/LAMPARA PILOTO/LAMPE TMOIN
- LCK OUT. - LOCK OUT/INTERRUPTOR DE BLOQUEO DE LA CUBIERTA/INTERRUPTEUR VERROU TABLE CUISSON

COLOR CODE/CODIGOS/CODE DE COULEUR

- BK. - BLACK/NEGRO/NOIR
- G. - GREEN/VERDE/VERT
- W. - WHITE/BLANCO/BLANC
- R. - RED/ROJO/ROUGE
- O. - ORANGE/NARANJA/ORANGE
- Y. - YELLOW/AMARILLO/JAUNE
- BR. - BROWN/MORENO/BRUN
- BL. - BLUE/AZUL/BLEU

**WIRE GAUGE TEMP. °C CSA UL
ALAMBRE MEDIDA
FIL CALIBRE**

WIRE FIL	GAUGE MEDIDA CALIBRE	TEMP. °C	CSA	UL
1	18	125	CL1251	3173
2	16	125	CL1251	3173
3	14	125	CL1251	3173
4	12	125	CL1251	3173
5	18	150	EXL-150	3321
6	16	150	EXL-150	3321
7	14	150	EXL-150	3321
8	12	150	EXL-150	3321
9	10	150	EXL-150	3321
10	18	200	SEW-1	3122
11	16	200	SEW-1	3122
12	12	250		3252
13	16	250		3252
14	20	150	EXL-150	3321
15	8	150	EXL-150	3321
16	8	60		
17	10	60		
18	10	200	SEW-1	3122
19	20	125	CL1251	3173

**LIMITER/LIMITOR/
LIMITEUR
E.G.O./A.K.O.**

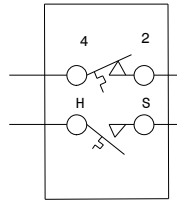

**LIMITER/LIMITOR/
LIMITEUR
CERAMASPEED/EIKA**

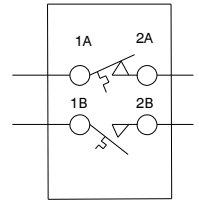

**CONNECTOR/EMPALME/
CONNECTEUR
B OR C**

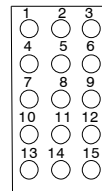

**CONNECTOR/EMPALME/
CONNECTEUR
A**

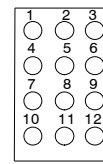

NOTE/NOTA/NOTE:
COMPONENTS SHOWN ARE NOT NECESSARILY USED ON ALL MODELS.
ESTOS COMPONENTES NO DEBEN DE APARECER EN TODOS LOS MODELOS.
LES COMPOSANTES MONTREES NE SONT PAS NECESSAIREMENT UTILISEES SUR TOUS LES MODELES.

**CAUTION: DISCONNECT CURRENT BEFORE REMOVING REAR COVER.
ATENCION: CORTAR EL CORRIENTE ANTES DE REALIZAR EL MANTENIMIENTO DEL ELECTRODOMESTICO.
ATTENTION: COUPEZ L'ALIMENTATION AVANT D'EFFECTUER LA REPARATION.**

318271928 REV:A