

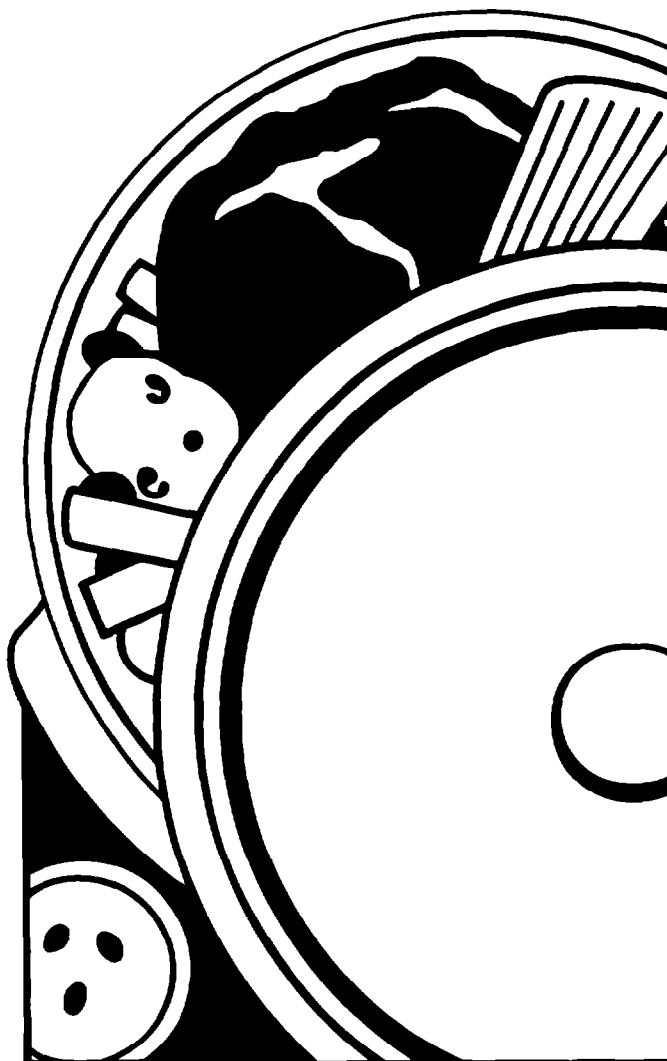

Making Your World  
A Little Easier.™

# Use And Care

## G U I D E



<b>Table of Contents</b> (complete) .....	2
<b>A Note to You</b> .....	3
<b>Microwave Oven</b> <b>Safety</b> .....	4-6
<b>Getting to Know</b> <b>Your Microwave</b> <b>Oven</b> .....	7
<b>Using Your</b> <b>Microwave Oven</b> .....	26
<b>Caring for Your</b> <b>Microwave Oven</b> .....	45
<b>Cooking Guide</b> .....	50
<b>Questions and</b> <b>Answers</b> .....	54
<b>If You Need</b> <b>Assistance</b> <b>or Service</b> .....	55
<b>Warranty</b> .....	60

**1-800-253-1301**

Call us with questions or comments.

12-916

**MICROWAVE HOOD COMBINATION**

PART NO. 3828W5A0265/4359338

**MODEL MH7135XE**

# Table of Contents

<b>A Note to You</b> .....	3	Using AUTO DEFROST .....	30
<b>Microwave Oven Safety</b> .....	4-6	Auto defrost chart .....	32
Important safety instructions .....	4	Defrosting tips .....	35
Precautions to avoid possible exposure to excessive microwave energy .....	5	Using WARM HOLD .....	36
Electrical requirements .....	6	Using PERSONAL CHOICE .....	37
<b>Getting to Know Your Microwave Oven</b> ...	7	Using "SENSOR QUICK TOUCH" COOK .....	38
How your microwave oven works .....	7	Using "SENSOR QUICK TOUCH" REHEAT .....	39
For the best cooking results .....	9	Using "SENSOR QUICK TOUCH" BAKED POTATO .....	40
Radio interference .....	9	Using "SENSOR QUICK TOUCH" POPCORN .....	41
Testing your microwave oven .....	9	Using "SENSOR QUICK TOUCH" PIZZA REHEAT .....	42
Testing your dinnerware or cookware ...	10	Using "SENSOR QUICK TOUCH" VEGETABLE .....	43
Operating safety precautions .....	10	Using ADD MINUTE .....	44
Electrical connection .....	12	Adding or subtracting cook time .....	44
Microwave oven features .....	13	<b>Caring for Your Microwave Oven</b> .....	45
Control panel features .....	14	Caring for the filters .....	46
Using the fan .....	18	Replacing the cooktop and oven lights .....	48
Using the cooktop/countertop light .....	20	<b>Cooking Guide</b> .....	50
Using the bi-level cooking rack .....	22	Reheating chart .....	50
Setting the clock .....	23	Microwave cooking chart .....	51
Using the Minute Timer .....	24	Microwave cooking tips .....	52
<b>Using Your Microwave Oven</b> .....	26	<b>Questions and Answers</b> .....	54
Cooking at high cook power .....	26	<b>If You Need Assistance or Service</b> .....	55
Cooking at different cook powers .....	27	<b>Warranty</b> .....	60
Cooking with more than one cook cycle .....	29		

# A Note to You

## **Thank you for buying a WHIRLPOOL® appliance.**

Because your life is getting busier and more complicated, WHIRLPOOL appliances are easy to use, save time, and help you manage your home better. To ensure that you enjoy years of trouble-free operation, we developed this Use and Care Guide. It is full of valuable information about how to operate and maintain your appliance properly and safely. Please read it carefully.

Also, please complete and mail in the **Product Registration Card** provided with your appliance. The card helps us notify you about any new information on your appliance.

## **Please record your model's information.**

Whenever you call to request service for your appliance, you need to know your complete model number and serial number. You can find this information on the model and serial number plate (see diagram in the "Microwave oven features" section).

Please also record the purchase date of your appliance and your dealer's name, address, and telephone number.

**Model Number** \_\_\_\_\_

**Serial Number** \_\_\_\_\_

**Purchase Date** \_\_\_\_\_

**Dealer Name** \_\_\_\_\_

**Dealer Address** \_\_\_\_\_

**Dealer Phone** \_\_\_\_\_

**Keep this book and the sales slip together in a safe place for future reference.**

**Our Consumer Assistance Center  
number is toll-free.**

**1-800-253-1301**

# Microwave Oven Safety

## Your safety is important to us.

This guide contains safety symbols and statements. Please pay special attention to these symbols and follow any instructions given. Here is a brief explanation of the use of the symbol.



This symbol alerts you to hazards such as fire, electrical shock, or other injuries.

## IMPORTANT SAFETY INSTRUCTIONS

When using electrical appliances basic safety precautions should be followed, including the following:

**WARNING:** To reduce the risk of burns, electric shock, fire, injury to persons, or exposure to excessive microwave energy:

- Read all instructions before using the microwave oven.
- Read and follow the specific "PRE-CAUTIONS TO AVOID POSSIBLE EXPOSURE TO EXCESSIVE MICROWAVE ENERGY" found in this section.
- The microwave oven must be grounded. Connect only to properly grounded outlet. See "GROUNDING INSTRUCTIONS" found at the end of this section.
- Install or locate the microwave oven only in accordance with the provided Installation Instructions.
- Some products such as whole eggs in the shell and sealed containers – for example, closed glass jars – may explode and should not be heated in the microwave oven.
- Use the microwave oven only for its intended use as described in this manual. Do not use corrosive chemicals or vapors in the microwave oven. This type of oven is specifically designed to heat, cook, or dry food. It is not designed for industrial or laboratory use.
- As with any appliance, close supervision is necessary when used by children.
- Do not operate the microwave oven if it has a damaged cord or plug, if it is not working properly, or if it has been damaged or dropped.
- The microwave oven should be serviced only by qualified service personnel. Call an authorized Whirlpool service company for examination, repair, or adjustment.
- Do not cover or block any openings on the microwave oven.
- Do not store the microwave oven outdoors. Do not use the microwave oven near water – for example, near a kitchen sink, in a wet basement, or near a swimming pool, and the like.
- Do not immerse cord or plug in water.
- Keep cord away from heated surfaces.
- Do not let cord hang over edge of table or counter.
- See door surface cleaning instructions in the "Caring for Your Microwave Oven" section.
- Suitable for use above both gas and electric cooking equipment.
- Intended to be used above ranges with maximum width of 36 inches.

### For microwave ovens with a ventilating hood:

- Clean Ventilating Hoods Frequently – Grease should not be allowed to accumulate on hood or filter.
- When flaming foods under the hood, turn the fan off. The fan, if operating, may spread the flame.
- Use care when cleaning the vent-hood filter. Corrosive cleaning agents, such as lye-based oven cleaners, may damage the filter.

- To reduce the risk of fire in the oven cavity:
  - Do not overcook food. Carefully attend the microwave oven if paper, plastic, or other combustible materials are placed inside the oven to facilitate cooking.
  - Remove wire twist-ties from paper or plastic bags before placing bag in oven.
  - If materials inside the oven should ignite, keep oven door closed, turn oven off, and disconnect the power cord, or shut off power at the fuse or circuit breaker panel.
- Do not use the cavity for storage purposes. Do not leave paper products, cooking utensils, or food in the cavity when not in use.
- Do not mount over a sink.
- Do not store anything directly on top of the microwave oven when the microwave oven is in operation.

**– SAVE THESE INSTRUCTIONS –**

## **PRECAUTIONS TO AVOID POSSIBLE EXPOSURE TO EXCESSIVE MICROWAVE ENERGY...**

- (a) Do not attempt to operate this oven with the door open since open-door operation can result in harmful exposure to microwave energy. It is important not to defeat or tamper with the safety interlocks.
- (b) Do not place any object between the oven front face and the door or allow soil or cleaner residue to accumulate on sealing surfaces.
- (c) Do not operate the oven if it is damaged. It is particularly important that the oven door close properly and that there is no damage to the:
  - (1) Door (bent),
  - (2) Hinges and latches (broken or loosened),
  - (3) Door seals and sealing surfaces.
- (d) The oven should not be adjusted or repaired by anyone except properly qualified service personnel.

## Electrical requirements

Observe all governing codes and ordinances. A 120 Volt, 60 Hz, AC only, 15 amp fused electrical supply is required. (A time-delay fuse is recommended.) It is recommended that a separate circuit serving only this appliance be provided.

### **⚠ WARNING**



#### **Electrical Shock Hazard**

**Plug into a grounded 3 prong outlet.**

**Do not remove ground prong.**

**Do not use an adapter.**

**Do not use an extension cord.**

**Failure to follow these instructions can result in death, fire, or electrical shock.**

## GROUNDING INSTRUCTIONS

For all cord connected appliances: The microwave oven must be grounded. In the event of an electrical short circuit, grounding reduces the risk of electric shock by providing an escape wire for the electric current. The microwave oven is equipped with a cord having a grounding wire with a grounding plug. The plug must be plugged into an outlet that is properly installed and grounded.

**WARNING:** Improper use of the grounding can result in a risk of electric shock.

Consult a qualified electrician or serviceman if the grounding instructions are not completely understood, or if doubt exists as to whether the microwave oven is properly grounded.

Do not use an extension cord. If the power supply cord is too short, have a qualified electrician or serviceman install an outlet near the microwave oven.

For a permanently connected appliance: This appliance must be connected to a grounded, metallic, permanent wiring system, or an equipment grounding conductor should be run with the circuit conductors and connected to the equipment grounding terminal or lead on the appliance.

# Getting to Know Your Microwave Oven

This section discusses the concepts behind microwave cooking. It also shows you the basics you need to know to operate your microwave oven. Please read this information before you use your oven.

	<p><b>!WARNING</b></p> <p><b>Explosion Hazard</b></p> <p><b>Do not store flammable materials such as gasoline near the microwave oven.</b></p> <p><b>Doing so can result in death, explosion, fire, or burns.</b></p>
---	---

## How your microwave oven works

**Microwave ovens are safe.** Microwave energy is not hot. It causes food to make its own heat, and it's this heat that cooks the food.

Microwaves are like TV waves or light waves. You cannot see them, but you can see what they do.

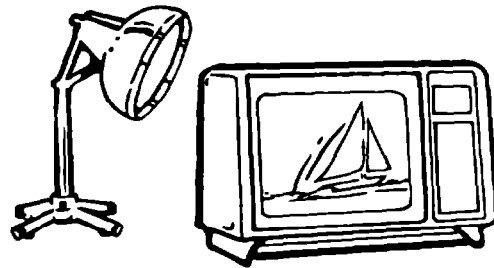

**A magnetron** in the microwave oven produces microwaves. The microwaves move into the oven where they contact food as it turns on the turntable.

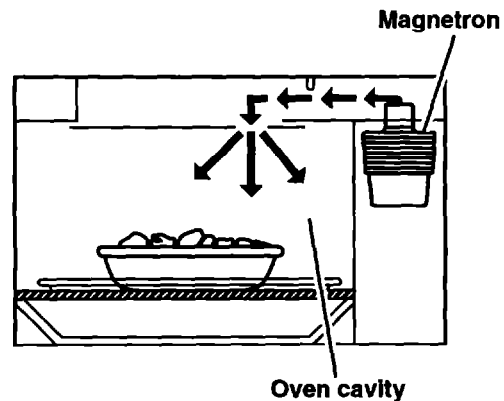

## GETTING TO KNOW YOUR MICROWAVE OVEN

The **glass turntable** of your microwave oven lets microwaves pass through. Then they bounce off a metal floor, back through the glass turntable, and are absorbed by the food.

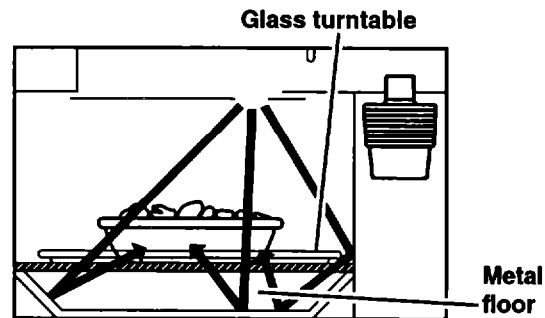

**Microwaves** pass through most glass, paper, and plastics without heating them so food absorbs the energy. Microwaves bounce off metal containers so food does not absorb the energy.

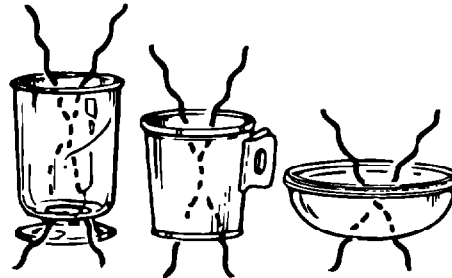

**Microwaves** may not reach the center of a roast. The heat spreads to the center from the outer, cooked areas just as in regular oven cooking. This is one of the reasons for letting some foods (for example, roasts or baked potatoes) stand for a while after cooking, or for stirring some foods during the cooking time.

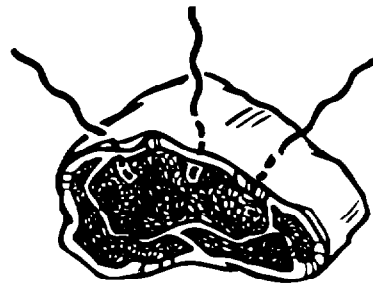

The microwaves disturb water molecules in the food. As the molecules bounce around bumping into each other, heat is made, like rubbing your hands together. This is the heat that does the cooking.

**NOTE:** Do not deep fry in the oven. Microwavable cookware is not suitable and it is difficult to maintain appropriate deep frying temperatures.



---

## For the best cooking results

- **Always cook** food for the minimum recommended cooking time. If necessary, touch ADD MINUTE while the oven is operating or after it has completed the cooking cycle (see "Using ADD MINUTE" in the "Using Your Microwave" section for more information). Then check for doneness to avoid overcooking the food.
- **Stir, turn over, or rearrange the food** being cooked about halfway through the cooking time for all recipes. This will help you make sure food is cooked evenly.
- **If you cannot find** a glass cover, use wax paper, paper towels, or microwave-approved plastic wrap. Turn back a corner to vent steam during cooking.

---

## Radio interference

Using your microwave oven may cause interference to your radio, TV, or similar equipment. When there is interference, you can reduce it or remove it by:

- **Cleaning** the door and sealing surfaces of the oven.
- **Adjusting** the receiving antenna of the radio or television.
- **Moving** the receiver away from the microwave oven.
- **Plugging** the microwave oven into a different outlet so that the microwave oven and receiver are on different branch circuits.

---

## Testing your microwave oven

To test the oven put about 1 cup of cold water in a glass container in the oven. Close the door. Make sure it latches. Follow the directions in the "Cooking at high cook power" section to set the oven to cook for 2 minutes. When the time is up, the water should be heated.



## Testing your dinnerware or cookware

### Test dinnerware or cookware before using.

To test a dish for safe use, put it into the oven with a cup of water beside it. Cook at 100% cook power for one minute. **If the dish gets hot and water stays cool, do not use it.**

Some dishes (melamine, some ceramic dinnerware, etc.) absorb microwave energy, becoming too hot to handle and slowing cooking times. Cooking in metal containers not designed for microwave use could damage the oven, as could containers with hidden metal (twist-ties, foil lining, staples, metallic glaze or trim).

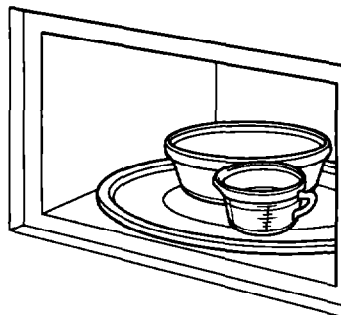

## Operating safety precautions

**Never cook or reheat a whole egg inside the shell.** Steam buildup in whole eggs may cause them to burst and burn you, and possibly damage the oven. **Slice** hard-boiled eggs before heating. In rare cases, poached eggs have been known to explode. **Cover** poached eggs and **allow** a standing time of one minute before cutting into them.

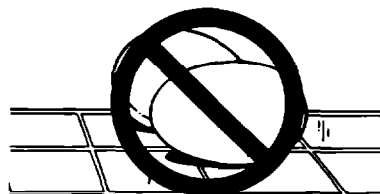

**For best results, stir any liquid several times before heating or reheating.** Liquids heated in certain containers (especially containers shaped like cylinders) may become overheated. The liquid may splash out with a loud noise during or after heating or when adding ingredients (coffee granules, tea bags, etc.). This can harm the oven and possibly injure someone.



Stir before heating

**Never lean on the door or allow a child to swing on it when the door is open.** Injury could result.

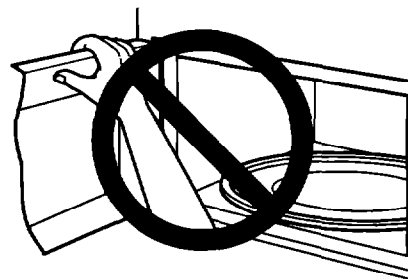

## GETTING TO KNOW YOUR MICROWAVE OVEN

**Use hot pads.** Microwave energy does not heat containers, but heat from the food can make the container hot.

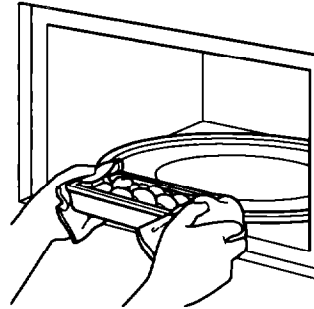

**Do not overcook potatoes.** Fire could result. At the end of the recommended cooking time, potatoes should be slightly firm because they will continue cooking during standing time. **After microwaving, wrap** potatoes in foil and **set aside** for 5 minutes. They will finish cooking while standing.

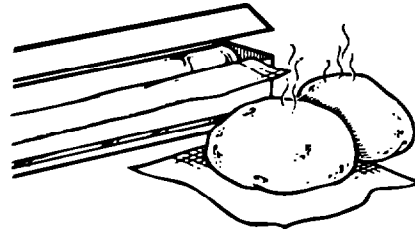

**Do not** start a microwave oven when it is empty. Product life may be shortened.

If you practice programming the oven, **put** a container of water in the oven.

It is normal for the oven door to look wavy after the oven has been running for a while.

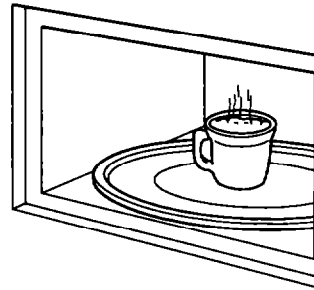

**Do not** use newspaper or other printed paper in the oven. Fire could result.

**Do not** dry flowers, fruit, herbs, wood, paper, gourds, or clothes in the oven. Fire could result.

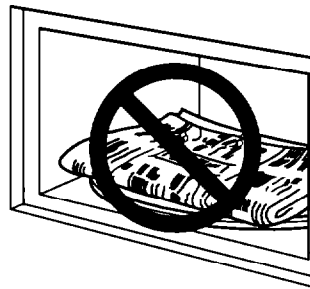

## GETTING TO KNOW YOUR MICROWAVE OVEN

**Do not** try to melt paraffin wax in the oven. Paraffin wax will not melt in a microwave oven because it allows microwaves to pass through it.

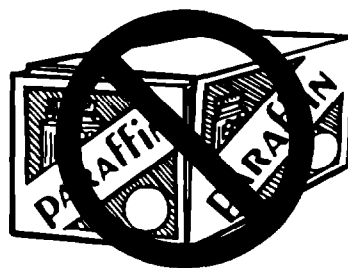

**Do not** operate the microwave oven unless the glass turntable is securely in place and can rotate freely. The turntable can rotate in either direction.

**Make sure** the turntable is correct-side up in the oven. **Carefully place** the cookware on your turntable to avoid possibly breaking it.

**Handle your turntable with care** when removing it from the oven to avoid possibly breaking it. If your turntable cracks or breaks, contact your Whirlpool dealer for a replacement.

When you use a browning dish, the browning dish bottom must be at least  $\frac{3}{16}$  inch above the turntable. Follow the directions supplied with the browning dish.

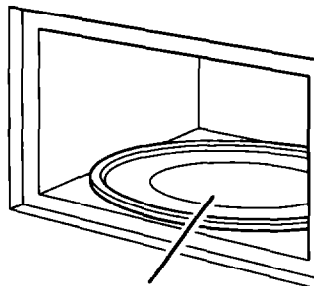

Glass turntable

---

## Electrical connection

If your electric power line or outlet voltage is less than 110 volts, cooking times may be longer. Have a qualified electrician check your electrical system.

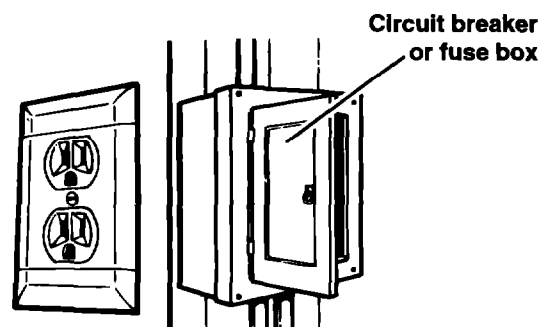

## Microwave oven features

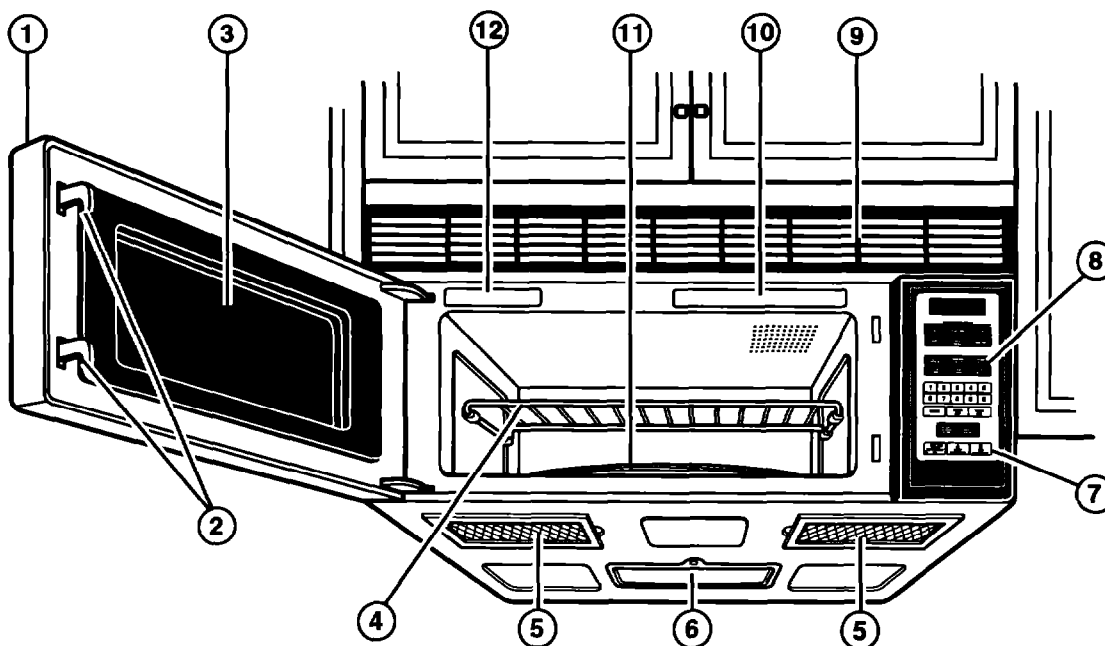

Your microwave oven is designed to make your cooking experience as enjoyable and productive as possible. To get you up and running quickly, the following is a list of the oven's basic features:

1. **Door Handle.** Pull to open door.
2. **Door Safety Lock System.** The oven will not operate unless the door is securely closed.
3. **Window with Metal Shield.** The shield prevents microwaves from escaping. It is designed as a screen to allow you to view food as it cooks.
4. **Two-Position BI-Level Cooking Rack.** Use for extra space when cooking in more than one container at the same time. See page 22 for more information.
5. **Filter.** See page 46 for cleaning information.
6. **Cooktop/Countertop Light.** Turn on to light your cooktop or countertop or to use as a night light. See page 20 for more information.
7. **Turntable, Fan, and Cooktop Light Switches.** See pages 16, and 18-21 for more information.
8. **Control Panel.** Touch the pads on this panel to perform all functions. See pages 14-16 for more information.
9. **Vent Grille.**
10. **Cooking Guide.** Use as a quick reference for Auto Defrost and Sensor Cook settings.
11. **Glass Turntable.** The turntable turns food as it cooks for more even cooking. It must be in the oven during operation for best cooking results. See pages 12, 16, and 45 for more information.
12. **Model and Serial Number Plate.**

## Control panel features

Your microwave oven control panel lets you select the desired cooking function quickly and easily. All you have to do is touch the necessary Command Pad. The following is a list of all the Command and Number Pads located on the control panel. For more information, see pages 18-44.

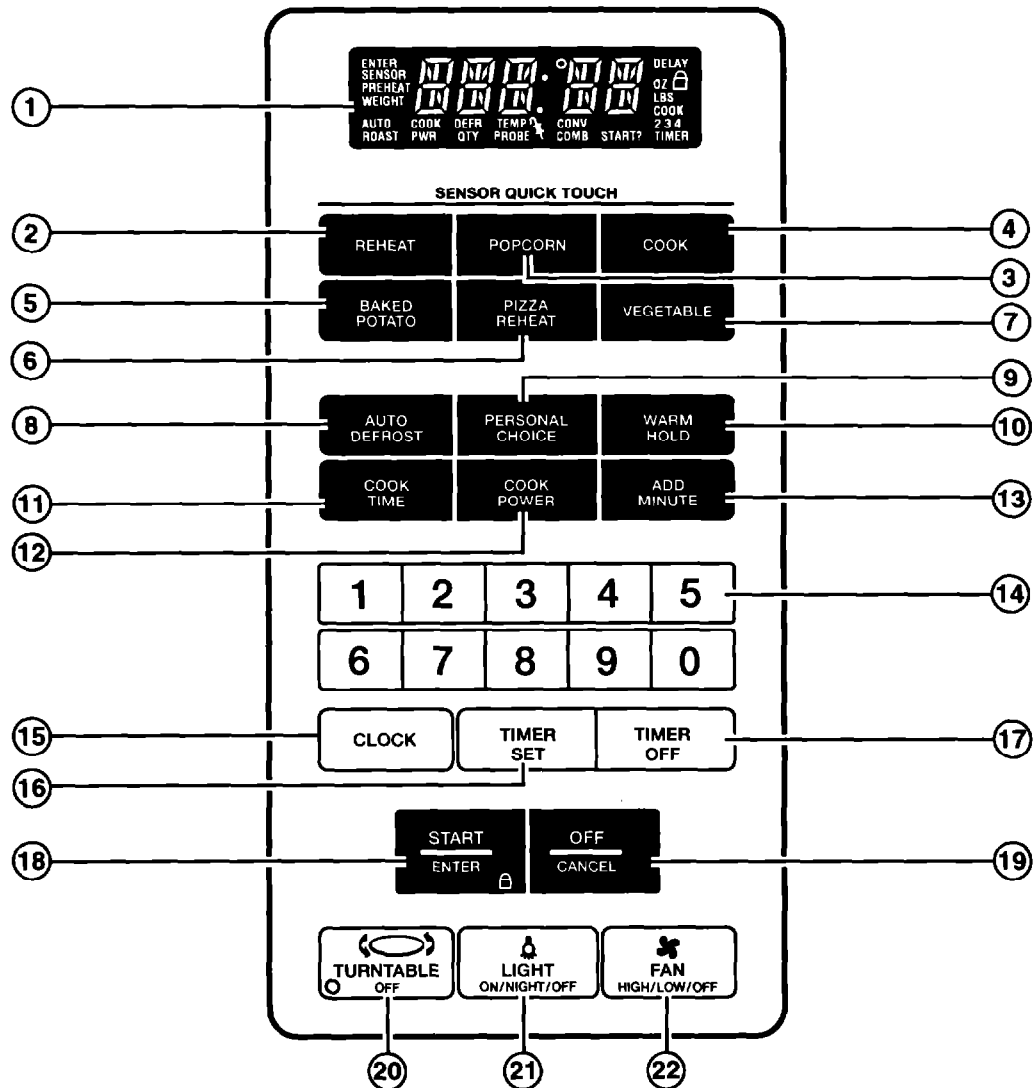

**1. DISPLAY.** The display includes a clock and indicators to tell you time of day, cooking time settings, and cooking functions selected.

**2. REHEAT.** Touch this pad to reheat food with the "SENSOR QUICK TOUCH" feature. The oven's sensor will tell the oven how long to heat depending on the amount of humidity it detects from the food. See page 39 for more information.

## GETTING TO KNOW YOUR MICROWAVE OVEN

3. **POPCORN.** Touch this pad to pop popcorn with the "SENSOR QUICK TOUCH" feature. The oven's sensor will tell the oven how long to cook depending on the amount of humidity it detects from the popcorn. See page 41 for more information.
4. **COOK.** Touch this pad to cook common microwave-prepared foods with the "SENSOR QUICK TOUCH" feature. The oven's sensors will tell the oven how long to cook depending on the amount of humidity it detects from the food. See page 38 for more information.
5. **BAKED POTATO.** Touch this pad to cook potatoes with the "SENSOR QUICK TOUCH" feature. The oven's sensors will tell the oven how long to cook depending on the amount of humidity it detects from the potatoes. See page 40 for more information.
6. **PIZZA REHEAT.** Touch this pad to reheat one or several slices of pizza with the "SENSOR QUICK TOUCH" feature. The oven's sensor will tell the oven how long to cook depending on the amount of humidity it detects from the pizza. See page 42 for more information.
7. **VEGETABLE.** Touch this pad to cook vegetables with the "SENSOR QUICK TOUCH" feature. The oven's sensor will tell the oven how long to cook depending on the amount of humidity it detects from the vegetables. See page 43 for more information.
8. **AUTO DEFROST.** Touch this pad followed by Number Pads to thaw frozen meat by weight. See pages 30-35 for more information.
9. **PERSONAL CHOICE.** Touch this pad to recall one cooking instruction previously programmed into memory. See page 37 for more information.
10. **WARM HOLD.** Touch this pad to keep hot, cooked foods safely warm in your oven for up to 99 minutes, 99 seconds. WARM HOLD can be used by itself, or it can automatically follow a cooking cycle. See page 36 for more information.
11. **COOK TIME.** Touch this pad followed by Number Pads to set a cooking time. See pages 26 and 28-29 for more information.
12. **COOK POWER.** Touch this pad after the cook time has been set, followed by a Number Pad to set the amount of microwave energy released to cook the food. The higher the number, the higher the microwave power or "cooking speed." See page 27 for more information. See the "Microwave cooking chart" on page 51 for specific Cook Powers to use for the foods you are cooking.
13. **ADD MINUTE.** Touch this pad to cook for 1 minute, at 100% Cook Power, or to add an extra minute, at the set Cook Power to your cooking cycle. See page 44 for more information.
14. **Number Pads.** Touch Number Pads to enter cooking times, Cook Powers, temperatures, quantities, weights, or food categories.
15. **CLOCK.** Touch this pad to enter the correct time of day. See page 23 for more information.
16. **TIMER SET.** Touch this pad to set the Minute Timer. See page 24 for more information.
17. **TIMER OFF.** Touch this pad to cancel the Minute Timer. See page 25 for more information.
18. **START/ENTER.** Touch this pad to start a function. If you open the door after the oven begins to cook, retouch START/ENTER. See page 16 for more information.
19. **OFF/CANCEL.** Touch this pad to erase an incorrect command, cancel a program during cooking, or to clear the Display. See page 16 for more information.

continued on next page

- 20. TURNTABLE OFF.** Touch this pad to stop the turntable only during the WARM HOLD and cook time functions. Stop the turntable only if the dish you are using is too long to turn inside the oven.

To stop the turntable, touch TURNTABLE OFF before touching START/ENTER. The red light on the TURNTABLE OFF pad will come on. If you do not program a function within 1 minute of pressing TURNTABLE OFF, the turntable will automatically turn back on and the red light will go off.

To turn the turntable back on, touch TURNTABLE OFF at any time during the programmed cycle. See pages 12, 13, and 45 for more turntable information.

- 21. LIGHT.** Touch this pad to turn on the cooktop/countertop light. See page 20 for more information.

- 22. FAN.** Touch this pad to turn the fan on or off. See page 18 for more information.

## NOTES:

- **If you have entered** all settings for a function but do not touch the START/ENTER pad within 5 seconds, the Start? indicator light will appear.
- **If you open the door** while the oven is on and then shut the door, the Start? indicator light will appear. Touch the START/ENTER pad to restart the oven.
- **If you choose** a function but do not press another Command Pad within 1 minute, the display returns to the time of day and you must start over.

## Audible signals

Audible signals are available to guide you when setting and using your oven:

- **A programming tone will sound** each time you touch a pad.
- **One long tone** signals the end of a Minute Timer countdown.
- **Four tones** signal the end of a cooking cycle.
- **Two tones** sound once every minute after an End-of-Cooking signal as a reminder if food has not been removed from oven.
- **Three tones** sound if you have made an incorrect entry.

### To disable all audible signals:

- **Touch and hold** Number Pad 1 for 4 seconds to disable all programming tones.

### To turn all signals back on:

Repeat step under "To disable all audible signals" above.

**NOTE:** Three tones, followed by two tones, will sound when audible signals are turned on or off. The three tones will be omitted if all tones are disabled.

## Interrupting cooking

You can stop the oven during a cycle by opening the door. The oven stops heating and the fan stops, but the light stays on. **To restart cooking, close the door and**

### TOUCH



**If you do not want to continue cooking:**

- **Close** the door and the light goes off.

**OR**

- **TOUCH**







## Using the safety lock

The safety lock prevents unwanted use of the microwave oven by disabling the control panel Command Pads.

### To lock or deactivate the control panel:

Touch and hold START/ENTER for 4 seconds. Three tones, followed by 2 tones, will sound and  will appear on the Display.

### To cancel the safety lock:

Touch and hold START/ENTER for 4 seconds. Two tones will sound and  will be cleared from the Display.

## Using the learning feature

You can see your microwave oven's functions without turning the oven on.

**NOTE:** This feature can only be used when the microwave oven is first connected to power. You cannot use the learning feature after a Command Pad has been touched.

### To set the learning feature:

1. **Open** the door and **keep** it open.
2. **Touch and hold** Number Pad 0 for 4 seconds. Three tones, followed by two tones, will sound.
3. **Release** Number Pad 0.
4. **Shut** the door to start the learning feature.

### To cancel the learning feature:

Touch OFF/CANCEL.

## Using the fan

The Fan pad on the bottom right of the control panel controls the 2-speed Fan.

### 1. Choose fan speed.

**NOTE:** If the temperature gets too hot around the microwave oven, the fan in the vent hood will automatically turn on at the LOW setting to protect the oven. It may stay on up to an hour to cool the oven. When this occurs, the FAN pad will not turn the fan off.

TOUCH



(once for HIGH)

OR



(twice for LOW)

### 2. Turn off fan when desired.

TOUCH



(until OFF)

## To set fan to run for a specific time:

### 1. Start fan.

TOUCH



(once or twice)

### 2. Choose TIMER SET.

#### NOTES:

- **Be sure** you have set a time of day with the CLOCK function before setting any TIMER function.
- **If both** the fan and light are operating and the TIMER pad is touched twice, both the fan and light will be controlled by the timer. The Display will alternate between "FAN" and "LIGHT" one time before "HR:MN" is displayed.

TOUCH



(twice within 3 seconds)

YOU SEE



# GETTING TO KNOW YOUR MICROWAVE OVEN

## 3. Set stop time.

Example to stop the fan at 1:30, when time of day is 12 o'clock:

**NOTE:** You can set the stop time up to the next 12 hours.

TOUCH

1

3

0

YOU SEE

ENTER 1:30 TIME

## 4. Start timed fan function.

**NOTE:** The letter "F" indicates the timed fan feature has been selected. If both the timed fan and light feature have been selected, an "H" (Hood) will be displayed.

At end of time, the current time of day will show and no tones will sound.

TOUCH

START  
ENTER

OR

TIMER  
SET

YOU SEE

F 12:00

## To check the stop time:

The set time will be displayed for 3 seconds.

TOUCH

TIMER  
SET

## To cancel the timed fan function:

**NOTE:** Touching the TIMER OFF pad shuts off both the fan and the timed function. Touching the Fan pad shuts off just the fan.

TOUCH

TIMER  
OFF

## Using the cooktop/countertop light

The pad on the bottom center of the control panel controls the cooktop/countertop light.

### 1. Turn on light.

Press the LIGHT pad once for HIGH, twice for LOW (night light).

**TOUCH**



**(once for HIGH)**

**OR**



**(twice for LOW)**

### 2. Turn off light when desired.

**TOUCH**



**(until OFF)**

## To set light to be on for a specific time:

### 1. Turn on light.

**TOUCH**



**(once or twice)**

### 2. Choose TIMER SET.

**NOTES:**

- **Be sure** you have set a time of day with the CLOCK function before setting any TIMER function.
- **If both** the fan and light are operating and the TIMER pad is touched twice, both the fan and light will be controlled by the timer. The Display will alternate between "FAN" and "LIGHT" one time before "HR:MN" is displayed.

**TOUCH**



**(twice within 3 seconds)**

**YOU SEE**



# GETTING TO KNOW YOUR MICROWAVE OVEN

## 3. Set stop time.

Example to turn off light at 2 o'clock, when time of day is 12 o'clock:

**NOTE:** You can set the time up to the next 12 hours.

TOUCH



YOU SEE



## 4. Start timed fan function.

**NOTE:** The letter "L" indicates the timed light feature has been selected. If both the timed fan and light feature have been selected, an "H" (Hood) will be displayed.

At end of time, the current time of day will show and no tones will sound.

TOUCH



OR



YOU SEE



(time of day)

## To check the stop time:

The set time will be displayed for 3 seconds.

TOUCH



## To cancel the timed light function:

**NOTE:** Touching the TIMER OFF pad shuts off both the light and the timed function. Touching the LIGHT pad shuts off just the light.

TOUCH



## Using the bi-level cooking rack

The Bi-Level Cooking Rack gives you extra space when cooking in more than one container at the same time. The metal rack can be turned upside-down to help fit taller containers on the bottom of the oven.

If you need a replacement rack, you can order one from your authorized Whirlpool service company, or by calling the Consumer Assistance Center at **1-800-253-1301**. Make sure to have your model number when ordering.

### Inserting the rack

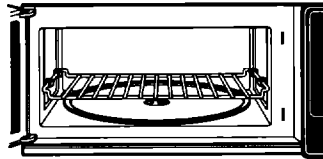

**First position:** Insert the rack securely into the rack supports on the side walls of the oven.

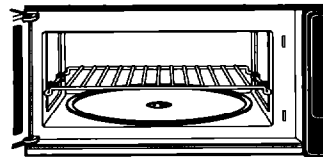

**Second position:** Turn rack upside-down when using a taller container on the bottom of the oven.

## ⚠ WARNING



### Burn Hazard

**Use oven mitts to remove items from microwave.**

**Do not touch areas near oven vent openings during use.**

**Failure to follow these instructions can result in burns.**

### NOTES:

- **Do not store** the metal rack in the oven. Arcing and damage to the oven could result if someone accidentally starts the oven.
- **Do not operate** the oven with the metal rack stored on the floor of the oven. Damage to the interior finish will result.
- **Use rack** only in the microwave oven.
- **Do not use rack** with browning dish.
- **Do not let food** container on rack touch the top or sides of the oven.
- **Do not cook foods** directly on rack without putting them in containers first.
- **Do not place** a metal cooking container on rack. Place a microwave-safe plate under container.
- **Only use** the Bi-Level Cooking Rack when cooking at more than one level.

## Setting the clock

When your microwave oven is first plugged in or after a power failure, the Display will show "888:88". For the first 30 seconds after the power is on, you can set the clock time without touching CLOCK. After 30 seconds have gone by, you must follow the directions below to set the time. If a time of day is not set, "888:88" will show on the Display until you touch CLOCK.

### NOTES:

- If you enter in an incorrect time and touch CLOCK, three tones will sound. Enter the correct time.
- If you touch OFF/CANCEL while setting the clock, the Display will show the last time of day set or ":" if no time of day has been set.

### To set time:

#### 1. Choose setting.

##### TOUCH

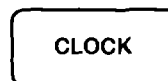

##### YOU SEE



(for 3 seconds)

#### 2. Enter time of day.

Example for 12:00:

##### TOUCH



##### YOU SEE



#### 3. Complete entry.

##### TOUCH

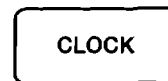

OR



##### YOU SEE



## Using the Minute Timer

You can use your microwave oven as a minute timer. Use the Minute Timer for timing up to 99 minutes, 99 seconds.

**NOTE:** The oven can operate while the Minute Timer is in use. To see the Minute Timer while the oven is cooking, touch **TIMER SET**. The Display will return to the cooking time countdown in 3 seconds.

### 1. Touch **TIMER SET**.

**TOUCH**



**YOU SEE**



**Then:**



### 2. Enter time to be counted down.

Example for 1 minute, 30 seconds:

**NOTE:** If you enter more than 4 digits, three tones will sound. Touch **START/ENTER** to count down the 3-digit time you have entered or touch **TIMER OFF** to clear the Display. To start over, touch **TIMER SET** and re-enter desired time.

**TOUCH**



**YOU SEE**



### 3. Start countdown.

**NOTE:** If you do not do this step within 3 seconds of doing Step 2, "START?" will appear. You then have 1 minute to touch **START/ENTER** or **TIMER SET** before the Display returns to time of day.

**TOUCH**



**OR**



**YOU SEE**





# GETTING TO KNOW YOUR MICROWAVE OVEN

At end of countdown:

YOU SEE



(one tone will sound)

---

## To cancel Minute Timer:

During countdown:

TOUCH



YOU SEE



(time of day)

After countdown:



# Using Your Microwave Oven

This section gives you instructions for operating each function. Please read these instructions carefully.

## Cooking at high cook power

1. Put food in oven and close the door.

- 
2. Set cooking time.

TOUCH



YOU SEE



Example for 1 minute, 30 seconds:

TOUCH



YOU SEE

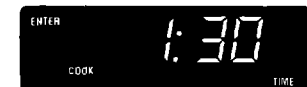

- 
3. Start oven.

TOUCH



YOU SEE

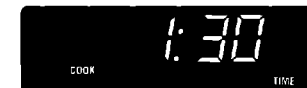

At end of cooking time:

YOU SEE



---

### Changing instructions

You can change the cooking time after cooking starts by repeating Steps 2 and 3.

## Cooking at different cook powers

For best results, some recipes call for different Cook Powers. The lower the Cook Power, the slower the cooking. Each Number Pad also stands for a different percentage of Cook Power. Many microwave cookbook recipes tell you by number, percent, or name which Cook Power to use.

The following chart gives the percentage of Cook Power each Number Pad stands for, and the Cook Power name usually used. It also tells you when to use each Cook Power. Follow recipe or food package instructions if available.

COOK POWER	NAME	WHEN TO USE IT
Automatic 100% of full power	High	<ul style="list-style-type: none"> <li>• Quick heating many convenience foods and foods with high water content, such as soups and beverages</li> <li>• Cooking tender cuts of meat, ground meat, poultry pieces, fish fillets, and vegetables</li> </ul>
9=90% of full power		<ul style="list-style-type: none"> <li>• Heating cream soups</li> </ul>
8=80% of full power		<ul style="list-style-type: none"> <li>• Heating rice, pasta, or casseroles</li> </ul>
7=70% of full power	Medium-High	<ul style="list-style-type: none"> <li>• Cooking and heating foods that need a Cook Power lower than high (for example, whole fish and meat loaf) or when food is cooking too fast</li> <li>• Reheating a single serving of food</li> </ul>
6=60% of full power		<ul style="list-style-type: none"> <li>• Cooking requiring special care, such as cheese and egg dishes, pudding, and custards</li> <li>• Finishing cooking casseroles</li> </ul>
5=50% of full power	Medium	<ul style="list-style-type: none"> <li>• Cooking ham, whole poultry, and pot roasts</li> <li>• Melting chocolate</li> </ul>
4=40% of full power		<ul style="list-style-type: none"> <li>• Simmering stews</li> <li>• Heating pastries</li> </ul>
3=30% of full power	Medium-Low, Defrost	<ul style="list-style-type: none"> <li>• Defrosting foods, such as bread, fish, meats, poultry, and precooked foods</li> </ul>
2=20% of full power		<ul style="list-style-type: none"> <li>• Softening butter, cheese, and ice cream</li> </ul>
1=10% of full power	Low	<ul style="list-style-type: none"> <li>• Keeping food warm</li> <li>• Taking chill out of fruit</li> </ul>

**NOTE:** Once cook time has been entered, you can also use the Cook Power pad as a second Minute Timer by entering "0" for the Cook Power. The oven will count down the cooking time you set without cooking.

# USING YOUR MICROWAVE OVEN

1. Put food in oven and close the door.

2. Set cooking time.

TOUCH



YOU SEE



Example for 7 minutes, 30 seconds:

TOUCH



YOU SEE

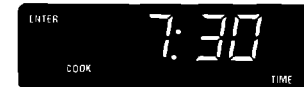

3. Set Cook Power.

TOUCH



YOU SEE



Example for 50% Cook Power:

TOUCH



YOU SEE



4. Start oven.

TOUCH



YOU SEE

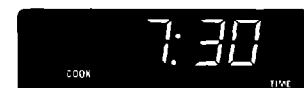

At end of cooking time:

YOU SEE



## Changing instructions

You can change the cooking time or Cook Power after the cooking starts by repeating Steps 2 and/or 3 and 4.

## Cooking with more than one cook cycle

For best results, some recipes call for one Cook Power for a certain length of time, and another Cook Power for another length of time. Your oven can be set to change from one to another automatically, for up to two cycles.

1. Put food in oven and close the door.

2. Set cooking time for first cycle.

TOUCH



YOU SEE



Example for 7 minutes, 30 seconds:

TOUCH



YOU SEE

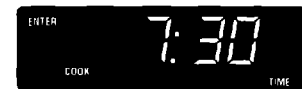

3. Set Cook Power for first cycle.

TOUCH



YOU SEE



Example for 50% Cook Power:

TOUCH



YOU SEE



4. Repeat Steps 2 and 3 to set cooking time and Cook Power for the second cycle.

continued on next page

## USING YOUR MICROWAVE OVEN

### 5. Start oven.

After the first cycle is over, the next cycle will count down.

#### TOUCH



#### YOU SEE



(first cycle)

At end of cooking time:

#### YOU SEE



### Changing instructions

You can change times or Cook Powers for a cycle any time after that cycle starts by repeating Steps 2 and/or 3 and 4.

## Using AUTO DEFROST

Your microwave oven automatically defrosts a variety of common meats at preset Cook Powers for preset times. The 2-stage defrost cycle is programmed for meat, poultry, and fish.

#### To use DEFROST:

1. **Touch** DEFROST once for meat, twice for poultry, or three times for fish.
2. **Wait** 4 seconds.
3. **Enter** the weight using the Number Pads.
4. **Touch** START/ENTER.

Refer to the following chart to choose a category:

CATEGORY	TOUCH DEFROST
Meat	once
Poultry	twice
Fish	three times

#### NOTES:

- **See** the "Auto defrost chart" later in this section for defrosting directions for each food.
- **To defrost items not listed** in "Auto defrost chart" later in this section, use 30% Cook Power. Refer to a reliable cookbook for defrosting information.

1. **Put frozen food in oven and close the door.**

## 2. Choose AUTO DEFROST.

Example for meat:

TOUCH



YOU SEE



Then:



## 3. Enter food's weight (in pounds and tenths of a pound).

Example for 1.2 lbs:

NOTES:

- For converting fractions of a pound to decimals, see "Weight conversion chart" at the end of the "Using Auto Defrost" section.
- If you enter an incorrect weight, touch AUTO DEFROST again and enter the correct weight.

TOUCH



YOU SEE



## 4. Start oven.

TOUCH



YOU SEE



## 5. After one third of the cook time is over, Display will prompt you to turn over food.

Open door, turn over food, and shield any warm portions.

**NOTE:** If you do not open the door within 2 minutes, the Display will resume the countdown.

YOU SEE



## 6. Restart oven.

TOUCH



YOU SEE



(approximate time remaining)

## USING YOUR MICROWAVE OVEN

7. After two thirds of the cook time is over, the display will prompt you to turn over food. Repeat the second half of Step 5 and Step 6.

At end of defrosting time:

YOU SEE



(approximate time remaining)

YOU SEE



## Auto defrost chart

### Meat setting

FOOD	AT PAUSE	SPECIAL INSTRUCTIONS
<b>Beef</b>		Meat of irregular shape and large, fatty cuts of meat should have the narrow or fatty areas shielded with foil at the beginning of a defrost cycle.
Ground Beef, Bulk	Remove thawed portions with fork. Turn over. Return remainder to oven.	Do not defrost less than ¼ lb. Freeze in doughnut shape.
Ground Beef, Patties	Separate and rearrange.	Do not defrost less than two 4 oz patties. Depress center when freezing.
Round Steak	Turn over. Cover warm areas with aluminum foil.	Place on a microwavable roasting rack.
Tenderloin Steak	Turn over. Cover warm areas with aluminum foil.	Place on a microwavable roasting rack.
Stew Beef	Remove thawed portions with fork. Separate remainder. Return remainder to oven.	Place in a microwavable baking dish.
Pot Roast, Chuck Roast	Turn over. Cover warm areas with aluminum foil.	Place on a microwavable roasting rack.
Rib Roast	Turn over. Cover warm areas with aluminum foil.	Place on a microwavable roasting rack.
Rolled Rump Roast	Turn over. Cover warm areas with aluminum foil.	Place on a microwavable roasting rack.



## USING YOUR MICROWAVE OVEN

FOOD	AT PAUSE	SPECIAL INSTRUCTIONS
<b>Lamb</b> Cubes for Stew  Chops (1 inch thick)	Remove thawed portions with fork. Return remainder to oven.  Separate and rearrange.	Place in a microwavable baking dish.  Place on a microwavable roasting rack.
<b>Pork</b> Chops (½ inch thick)  Hot Dogs  Spareribs, Country-Style Ribs  Sausage, Links Sausage, Bulk    Loin Roast, Boneless	Separate and rearrange.  Separate and rearrange.  Turn over. Cover warm areas with aluminum foil.  Separate and rearrange.  Remove thawed portions with fork. Turn over. Return remainder to oven.  Turn over. Cover warm areas with aluminum foil.	Place on a microwavable roasting rack.  Place on a microwavable roasting rack.  Place on a microwavable roasting rack.  Place on a microwavable roasting rack.  Place in a microwavable baking dish.    Place on a microwavable roasting rack.

### **Fish setting**

FOOD	AT PAUSE	SPECIAL INSTRUCTIONS
<b>Fish</b> Fillets  Steaks  Whole	Turn over. Separate fillets when partially thawed.  Separate and rearrange.  Turn over.	Place in a microwavable baking dish. Carefully separate fillets under cold water.  Place in a microwavable baking dish. Run cold water over to finish defrosting.  Place in a microwavable baking dish. Cover head and tail with foil; do not let foil touch sides of microwave oven. Finish defrosting by immersing in cold water.
<b>Shell Fish</b> Crabmeat Lobster Tails Shrimp Scallops	Break apart. Turn over.  Turn over and rearrange.  Separate and rearrange.  Separate and rearrange.	Place in a microwavable baking dish.  Place in a microwavable baking dish.  Place in a microwavable baking dish.  Place in a microwavable baking dish.

## USING YOUR MICROWAVE OVEN

FOOD	AT PAUSE	SPECIAL INSTRUCTIONS
<p><b>Chicken</b></p> <p>Whole (up to 9½ lbs)</p> <p>Cut Up</p>	<p>Turn over (finish defrosting breast-side down). Cover warm areas with aluminum foil.</p> <p>Separate pieces and rearrange.</p> <p>Turn over. Cover warm areas with aluminum foil.</p>	<p>Place chicken breast-side up on a microwavable roasting rack. Finish defrosting by immersing in cold water. Remove giblets when chicken is partially defrosted.</p> <p>Place on a microwavable roasting rack.</p> <p>Finish defrosting by immersing in cold water.</p>
<p><b>Cornish Hens</b></p> <p>Whole</p>	<p>Turn over. Cover warm areas with aluminum foil.</p>	<p>Place on a microwavable roasting rack. Finish defrosting by immersing in cold water.</p>
<p><b>Turkey</b></p> <p>Breast (under 6 lbs)</p>	<p>Turn over. Cover warm areas with aluminum foil.</p>	<p>Place on a microwavable roasting rack. Finish defrosting by immersing in cold water.</p>

## Weight conversion chart

You are probably used to food weights as being in pounds and ounces that are fractions of a pound (for example 4 ounces equals  $\frac{1}{4}$  pound). However, in order to enter food weight in AUTO DEFROST, you must specify pounds and tenths of a pound.

If the weight on the food package is in fractions of a pound, you can use the following chart to convert the weight to decimals.

NUMBER AFTER DECIMAL	EQUIVALENT OUNCE WEIGHT
.10	1.6
.20	3.2
.25    One-Quarter Pound	4.0
.30	4.8
.40	6.4
.50    One-Half Pound	8.0
.60	9.6
.70	11.2
.75    Three-Quarters Pound	12.0
.80	12.8
.90	14.4
1.00    One Pound	16.0

## Defrosting tips

- **When using** AUTO DEFROST, the weight to be entered is the net weight in pounds and tenths of pounds (the weight of the food minus the container).
- **Only use** AUTO DEFROST for raw food. AUTO DEFROST gives best results when food to be thawed is a minimum of 0°F. If food has been stored in a refrigerator-freezer that does not maintain a temperature of 0°F or below, always program a lower food weight (for a shorter defrosting time) to prevent cooking the food.
- **If the food is kept outside** the freezer for up to 20 minutes, enter a lower food weight.
- **If the food is kept outside** the freezer for more than 20 minutes, and for defrosting ready-made food, defrost by time and power and let stand after defrosting.
- **The shape of** the package affects how quickly food will defrost. Shallow packages will defrost more quickly than a deep block.
- **As food begins** to defrost, separate the pieces. Separated pieces defrost more evenly.
- **Use small pieces** of aluminum foil to shield parts of food such as chicken wings, leg tips, fish tails, or areas that start to get warm. Make sure the foil does not touch the sides, top, or bottom of the oven.
- **For better results, a preset standing time** is included in the defrosting time. This may make the defrosting time seem longer than expected. (For more information on standing time, see "Microwave cooking tips" in the "Cooking Guide" section.)

## Using WARM HOLD

You can safely keep hot, cooked food warm in your microwave oven for up to 99 minutes, 99 seconds (about 1 hour, 40 minutes). You can use WARM HOLD by itself, or to automatically follow a cooking cycle.

### NOTES:

- **WARM HOLD** operates for up to 99 minutes, 99 seconds.
- **Opening** the oven door cancels WARM HOLD. Close the door and touch WARM HOLD, then touch START/ENTER if additional WARM HOLD time is desired.
- **Food cooked covered** should be covered during WARM HOLD.
- **Pastry items** (pies, turnovers, etc.) should be uncovered during WARM HOLD.
- **Complete meals** kept warm on a dinner plate should be covered during WARM HOLD.
- **Do not use** more than one complete WARM HOLD cycle (about 1 hour, 40 minutes). The quality of some foods will suffer with extended time.

1. Put hot, cooked food in oven and close the door.

2. Choose setting.

TOUCH



YOU SEE



3. Start oven (optional).

TOUCH



YOU SEE



**To make WARM HOLD automatically follow another cycle:**

- While you are touching in cooking instructions, touch WARM HOLD before touching START/ENTER.
- When the last cooking cycle is over, you will hear two tones. "WARM" will come on while the oven continues to run.
- You can set WARM HOLD to follow AUTO DEFROST, COOK, or multi-cycle cooking.

## Using PERSONAL CHOICE

PERSONAL CHOICE allows you to recall one cooking instruction previously placed in memory and begin cooking quickly. For example, if you heat a roll every morning, program the cooking steps into PERSONAL CHOICE. You can heat your roll each morning by touching PERSONAL CHOICE.

PERSONAL CHOICE also allows you to program a function for another person to cook at a later time.

**NOTE:** You can reprogram PERSONAL CHOICE by repeating the instructions below. A power failure will erase your Personal Choice program.

### To program PERSONAL CHOICE:

#### 1. Choose PERSONAL CHOICE.

TOUCH

PERSONAL  
CHOICE

(for 4 seconds)

YOU SEE

ENTER  
PR CM

#### 2. Set cooking time.

TOUCH

COOK  
TIME

Example for 20 seconds:

TOUCH

2

0

YOU SEE

ENTER  
TIME  
COOK

YOU SEE

ENTER  
:20  
COOK TIME

#### 3. Set Cook Power.

TOUCH

COOK  
POWER

Example for 50% Cook Power:

TOUCH

5

YOU SEE

ENTER  
P- 10  
COOK PWR

YOU SEE

ENTER  
P- 5  
COOK PWR

#### 4. Complete entry.

TOUCH

PERSONAL  
CHOICE

YOU SEE

12:00

(time of day)

# USING YOUR MICROWAVE OVEN

## To use PERSONAL CHOICE:

1. Put food in oven and close the door.

2. Choose PERSONAL CHOICE.

The oven will cook according to your preprogrammed instructions.

### TOUCH

PERSONAL  
CHOICE

### YOU SEE

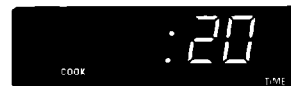

(display counts down programmed cooking time)

At end of cooking time:

### YOU SEE



## Using "SENSOR QUICK TOUCH" COOK

Using COOK lets you heat common microwave-prepared foods without needing to program times and Cook Powers. COOK has preset Cook Powers for 3 food categories: Frozen Entree, Casserole, and Rice.

### To use COOK:

1. Touch COOK (1 to 3 times) to select the desired category.
2. Four seconds after you complete your selection, the oven will start.
3. When the internal sensor detects a certain amount of humidity coming from the food, it will tell the oven how much longer to cook.

4. The display will show the remaining cooking time.

Refer to the following chart to choose a category:

CATEGORY	TOUCH COOK
Frozen Entree	once
Casserole	twice
Rice	three times

1. Put food in oven and close the door.

2. Choose COOK.

Example for casserole:

### TOUCH

COOK

COOK

(twice)

### YOU SEE



When sensor detects a certain amount of humidity from food, cooking time is displayed.

Example:

At end of cooking time:

**YOU SEE**



(this time will vary)

**YOU SEE**



## Using "SENSOR QUICK TOUCH" REHEAT

REHEAT lets you heat foods without needing to program times and Cook Powers. REHEAT has preset Cook Powers for 3 categories: Plate, Soup/Sauce, and Casserole.

**To use REHEAT:**

1. Touch REHEAT once for Plate, twice for Soup/Sauce, or three times for Casserole.
2. Four seconds after you complete your selection, the oven will start.
3. When the internal sensor detects a certain amount of humidity coming from the food, it will tell the oven how much longer to heat.

4. The display will show the remaining heating time.

**Refer to the following chart to choose a category:**

CATEGORY	TOUCH REHEAT
Plate	once
Soup/Sauce	twice
Casserole	three times

**NOTE:** See "Reheating chart" in the "Cooking Guide" section for reheating with cooking time and Cook Power.

1. Put food in oven and close the door.

2. Choose REHEAT.

Example for reheating soup or sauce:

**TOUCH**



**YOU SEE**



(twice)



continued on next page

## USING YOUR MICROWAVE OVEN

When sensor detects a certain amount of humidity from food, heating time is displayed.

Example:

At end of heating time:

YOU SEE



(this time will vary)

YOU SEE



## Using "SENSOR QUICK TOUCH" BAKED POTATO

Cooking with BAKED POTATO lets you bake one or several potatoes by touching one pad.

### NOTES:

- **Before baking**, pierce potato with fork several times.
- **After baking**, let stand for 5 minutes wrapped in foil.

1. Put potato in oven and close the door.

To use BAKED POTATO:

1. Touch BAKED POTATO just once.
2. Four seconds later the oven will start.
3. When the internal sensor detects a certain amount of humidity coming from the potatoes, it will tell the oven how much longer to cook.
4. The display will show the remaining cooking time.

2. Choose BAKED POTATO.

TOUCH



YOU SEE



YOU SEE



YOU SEE

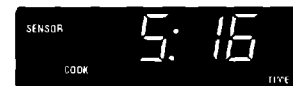

(this time will vary)

YOU SEE



When sensor detects a certain amount of humidity from the potato, cooking time is displayed.

Example:

At end of cooking time:



## Using "SENSOR QUICK TOUCH" POPCORN

POPCORN lets you pop commercially packaged microwave popcorn by touching just one pad.

Pop only one package at a time. If you are using a microwave popcorn popper, follow manufacturer's instructions.

Cooking performance may vary with brand and fat content. Try several brands to decide which gives best popping results. For best results, use fresh bags of popcorn.

### To use POPCORN:

1. Touch POPCORN just once.
2. Three seconds later, the oven will start.
3. When the internal sensor detects a certain amount of humidity coming from the popcorn, it will tell the oven how much longer to cook.
4. The display will show the remaining cooking time.

1. Place bag on rack and close the door.

⚠ WARNING



Fire Hazard

Do not repop unpopped kernels.  
Do not reuse popcorn bags.  
Doing so can result in death, fire,  
or burns.

### 2. Choose POPCORN.

#### TOUCH



#### YOU SEE



and



After "CORN" is displayed for a few seconds, your oven will begin heating.

#### YOU SEE



and



continued on next page

# USING YOUR MICROWAVE OVEN

When sensor detects a certain amount of humidity from popcorn, popping time is displayed.

Example:

At end of popping time:

**YOU SEE**



(remaining cook time alternates with "POP-" and "CORN"; this time will vary)

**YOU SEE**



---

## Using "SENSOR QUICK TOUCH" PIZZA REHEAT

Reheating pizza with PIZZA REHEAT lets you reheat one or several slices of pizza by touching one pad.

**To use PIZZA REHEAT:**

1. Touch PIZZA REHEAT just once.
2. Four seconds later the oven will start heating.
3. When the internal sensor detects a certain amount of humidity coming from the pizza, it will tell the oven how much longer to heat.
4. The display will show the remaining heating time.

---

**1. Place pizza in oven and close door.**

---

**2. Choose PIZZA REHEAT.**

**TOUCH**



**YOU SEE**



When sensor detects a certain amount of humidity from pizza, heating time is displayed.

Example:

At end of heating time:

**YOU SEE**

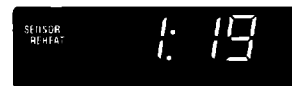

(this time will vary)

**YOU SEE**



## Using "SENSOR QUICK TOUCH" VEGETABLE

Cooking with VEGETABLE lets you heat common microwave-prepared vegetables without needing to program times and Cook Powers. VEGETABLE has preset cook powers for 3 food categories: Fresh, Frozen, and Canned.

### To use VEGETABLE:

1. **Touch** VEGETABLE once to select Fresh, twice for Frozen, or three times for Canned.
2. Four seconds after you complete your selection, the oven will start.

3. When the internal sensor detects a certain amount of humidity coming from the vegetables, it will tell the oven how much longer to cook.
4. The display will show the remaining cooking time.

Refer to the following chart to choose a category:

CATEGORY	TOUCH VEGETABLE
Fresh	once
Frozen	twice
Canned	three times

1. **Place vegetables in oven and close door.**

### 2. Choose VEGETABLE.

#### TOUCH



(twice)

#### YOU SEE



When sensor detects a certain amount of humidity from vegetables, cooking time is displayed.

Example:

At end of cooking time:

#### YOU SEE



(this time will vary)

#### YOU SEE



## Using ADD MINUTE

ADD MINUTE lets you cook food for 1 minute at 100% Cook Power or add an extra minute to your cooking cycle. You can also use it to extend cooking time in multiples of 1 minute, up to 99 minutes.

### NOTES:

- To extend cooking time in multiples of 1 minute, touch ADD MINUTE repeatedly during cooking.
- You can enter ADD MINUTE only after closing the door, after touching OFF/CANCEL, or during cooking.

- If you touch ADD MINUTE during cooking, the oven will cook at the currently selected Cook Power. If you touch ADD MINUTE after cooking is over, the oven will cook at 100% Cook Power.
- You can only use ADD MINUTE with nonsensor functions.

### 1. Make sure food is in oven.

### 2. Choose ADD MINUTE.

Example for cooking for 1 minute:

TOUCH



YOU SEE



## Adding or subtracting cook time

If the "Sensor Quick Touch" function is too long or too short, you can increase or decrease the cook time by 10% after choosing the function. You can only increase or decrease cook time before cooking starts.

To increase cook time by 10%:

TOUCH

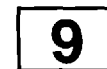

YOU SEE



To decrease cook time by 10%:

TOUCH



YOU SEE



To reset to the original cook time:

TOUCH

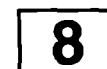

YOU SEE



# Caring for Your Microwave Oven

To make sure your microwave oven looks good and works well for a long time, you should maintain it properly. For proper care, please follow these instructions carefully.

**For interior surfaces:** Wash often with warm, sudsy water and a sponge or soft cloth. Use only mild, nonabrasive soaps or a mild detergent. Be sure to keep the areas clean where the door and oven frame touch when closed. Wipe well with clean water. Over time, stains can occur on the surfaces as the result of food particles spattering during cooking. This is normal.

For stubborn soil, **boil** a cup of water in the oven for 2 or 3 minutes. Steam will soften the soil. To get rid of odors inside the oven, **boil** a cup of water with lemon juice or vinegar.

**For exterior surfaces and control panel:** Use a soft cloth with spray glass cleaner. Apply the spray glass cleaner to the soft cloth; do not spray directly on the oven.

**NOTE:** Abrasive cleansers, steel-wool pads, gritty wash cloths, some paper towels, etc., can damage the control panel and the interior and exterior oven surfaces.

**To clean turntable and turntable support,** wash in mild, sudsy water; for heavily soiled areas use a mild cleanser and scouring sponge. The turntable and turntable support are dishwasher-safe.

## Cleaning the bi-level cooking rack

- Wash by hand with a mild detergent and a soft or nylon scrub brush. Dry completely.
- Do not use abrasive scrubbers or cleansers to clean rack.

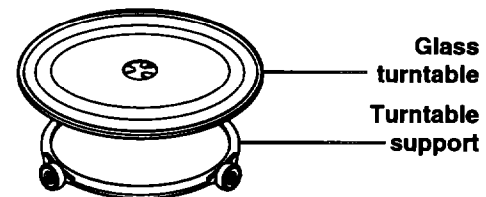
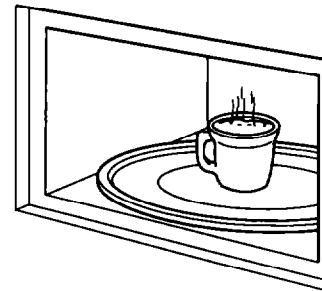
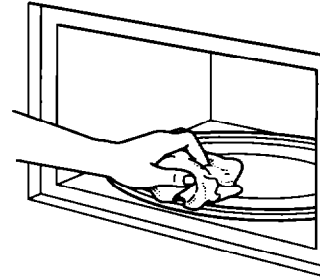

Glass  
turntable  
Turntable  
support

## Caring for the filters

Do not allow grease and soil to build up in the grease filters. It will decrease the exhaust fan efficiency. Remove and clean grease filters at least once a month. When you have removed a grease filter or a charcoal filter remember to replace the filter before you operate the hood.

**NOTE:** The charcoal filter is available as an accessory when the microwave oven is installed to recirculate air.

**⚠ WARNING**



**Electrical Shock Hazard**  
Disconnect power before removing vent cover.  
Replace all panels before operating.  
Failure to do so can result in death or electrical shock.

### Before removing filters:

- Unplug power cord or turn off power supply.

### Grease filters:

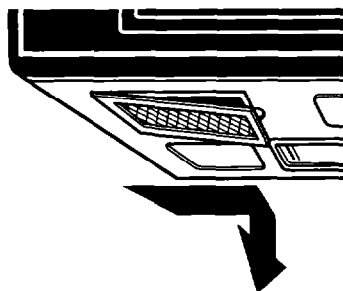

1. To remove grease filters, slide each filter to the side. Pull filters downward and push to the other side. The filter will drop out.

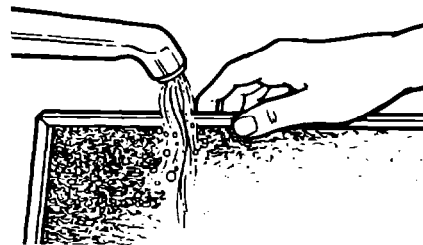

2. Soak grease filters in hot water and a mild detergent. Scrub and swish to remove embedded dirt and grease. Rinse well and shake to dry. Do not clean filters with ammonia, corrosive cleaning agents such as lye-based oven cleaners, or place them in a dishwasher. The filters will turn black or could be damaged.



3. To replace grease filters, slide filter in the frame slot on one side of the opening. Push filter upward and push to the other side to lock into place.

## Charcoal filter accessory:

Your microwave oven does not come equipped with a charcoal filter. If your microwave hood combination is being used to recirculate air, we recommend that you install the charcoal filter accessory. Replacement charcoal filters are available from your authorized Whirlpool service company, Part No. 4359416, or by calling the Consumer Assistance Center at **1-800-253-1301**. You cannot clean the charcoal filter and should replace it every 6-12 months.



1. **Remove** the vent cover mounting screws.
2. **Tip** the cover forward, then **lift out** to remove.

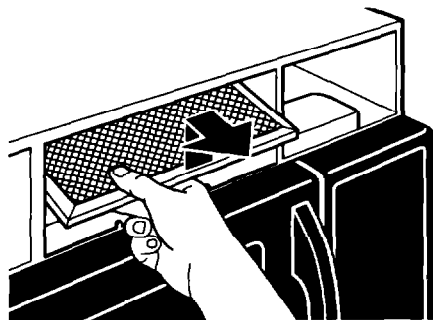

3. **If you need to remove an existing charcoal filter**, lift the front of the charcoal filter. Slide the filter straight out. If you are installing a filter for the first time go to Step 4.

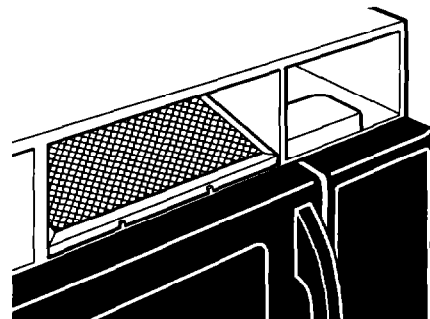

4. **Slide** a new charcoal filter into place. The filter should rest at the angle shown.

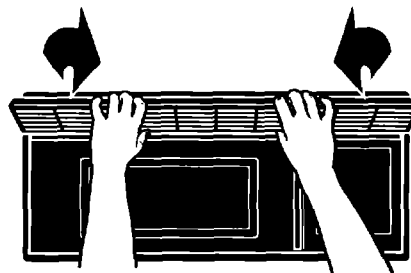

5. **Slide** the bottom of the vent cover into place. **Push** the top until it snaps into place. **Replace** the mounting screws.

## After replacing filters:

- Plug in power cord or turn on power supply.

## Replacing the cooktop and oven lights

### **⚠ WARNING**



#### **Fire Hazard**

**Use only candelabra-base bulbs, 30-watt maximum.**

**Turn off power at main power supply before replacing the light bulb.**

**Failure to follow the above could result in fire or electrical shock.**

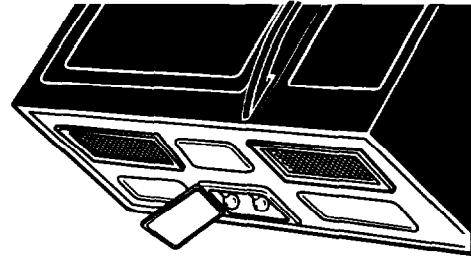

- 2. Remove** the bulb cover mounting screws.
- 3. We recommend** replacing bulb(s) with candelabra-base 30-watt bulb(s) available from your authorized Whirlpool service company, or by calling the Consumer Assistance Center at **1-800-253-1301**. Make sure to have your model number when ordering.
- 4. Turn** the power back on at the main power supply.

### **The cooktop light**

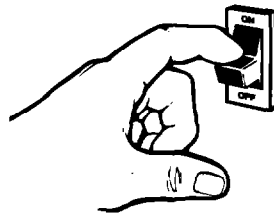

- 1. Turn off** power at the main power supply.



## The oven light

### ⚠ WARNING



**Electrical Shock Hazard**  
Disconnect power before removing vent cover.  
Replace all panels before operating.  
Failure to do so can result in death or electrical shock.

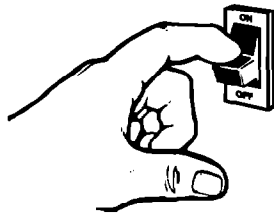

1. Turn off power at the main power supply.



2. Remove the vent cover mounting screws.
3. Tip the cover forward, then lift out to remove.

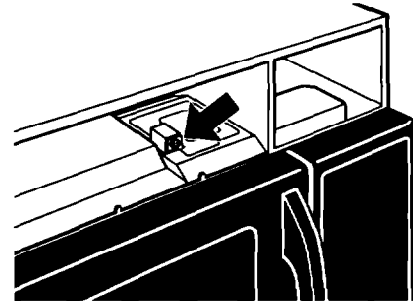

4. Remove bulb holder mounting screw.

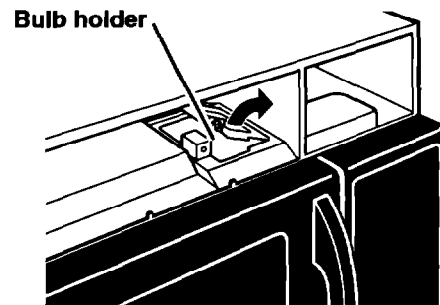

5. Lift up the bulb holder.
6. We recommend replacing the bulb with a candelabra-base 30-watt bulb available from your authorized Whirlpool service company, or by calling the Consumer Assistance Center at 1-800-253-1301. Make sure to have your model number when ordering.
7. Replace the bulb holder and mounting screw.

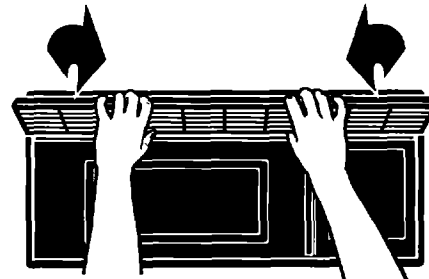

8. Slide the top of the vent cover into place. Push the bottom until it snaps into place. Replace the mounting screws. Turn the power back on at the main power supply.

# Cooking Guide

## Reheating chart

Times are approximate and may need to be adjusted to individual taste.

**NOTE:** See the "Using 'SENSOR QUICK TOUCH' REHEAT" in the "Using Your Microwave Oven" section for instructions on how to reheat by touching just one Command Pad.

ITEM	STARTING TEMP	TIME/POWER	PROCEDURE
<b>Meat</b> (Chicken pieces, chops, hamburgers, meat loaf slices) 1 serving 2 servings	Refrigerated Refrigerated	1-2 min at 70% 2½-4½ min at 70%	Cover loosely.
<b>Meat Slices</b> (Beef, ham, pork, turkey) 1 or more servings	Room temp Refrigerated	45 sec-1 min per serving at 50% 1-3 min per serving at 50%	Cover with gravy or wax paper. Check after 30 seconds per serving.
<b>Stirrable Casseroles and Main Dishes</b> 1 serving 2 servings 4-6 servings	Refrigerated Refrigerated Refrigerated	2-4 min at 100% 4-6 min at 100% 6-8 min at 100%	Cover. Stir after half the time.
<b>Nonstirrable Casseroles and Main Dishes</b> 1 serving 2 servings 4-6 servings	Refrigerated Refrigerated Refrigerated	5-8 min at 50% 9-12 min at 50% 13-16 min at 50%	Cover with wax paper.
<b>Soup, Cream</b> 1 cup 1 can (10¾ oz)	Refrigerated Room temp	3-4½ min at 50% 5-7 min at 50%	Cover. Stir after half the time.
<b>Soup, Clear</b> 1 cup 1 can (10¾ oz)	Refrigerated Room temp	2½-3½ min at 100% 4-5½ min at 100%	Cover. Stir after half the time.
<b>Pizza</b> 1 slice 1 slice 2 slices 2 slices	Room temp Refrigerated Room temp Refrigerated	15-25 sec at 100% 30-40 sec at 100% 30-40 sec at 100% 45-55 sec at 100%	Place on paper towel.
<b>Vegetables</b> 1 serving 2 servings	Refrigerated Refrigerated	¾-1½ min at 100% 1½-2½ min at 100%	Cover. Stir after half the time.
<b>Baked Potato</b> 1 2	Refrigerated Refrigerated	1-2 min at 50% 2-3 min at 50%	Cut potato lengthwise and then several times cross-wise. Cover with wax paper.
<b>Breads</b> (Dinner or breakfast roll) 1 roll 2 rolls 4 rolls	Room temp Room temp Room temp	8-12 sec at 50% 11-15 sec at 100% 18-22 sec at 100%	Wrap single roll, bagel, or muffin in paper towel. To reheat several, line plate with paper towel. Cover with another paper towel.
<b>Pie</b> Whole 1 slice	Refrigerated Refrigerated	5-7 min at 70% 30 sec at 100%	Cover with paper towel.

## Microwave cooking chart

Times are approximate and may need to be adjusted to individual taste.

**NOTE:** See "Using 'SENSOR QUICK TOUCH' COOK" in the "Using Your Microwave Oven" section for cooking without Cook Powers or cooking times.

<b>MEATS, POULTRY, FISH, SEAFOOD</b> Allow standing time after cooking.			<b>VEGETABLES (continued)</b> Cook at 100% cook power.		
<b>FOOD</b>	<b>COOK POWER</b>	<b>TIME</b>	<b>FOOD</b>	<b>TIME</b>	
<b>Bacon</b> (per slice)	100%	45 sec to 1 min 15 sec per slice	<b>Cauliflower</b> (medium head)	6-9 min	
<b>Ground Beef for Casseroles</b> (1 lb)	100%	4-6 min	<b>Corn on the Cob</b> (2) (4)	4-9 min 6-16 min	
<b>Hamburger Patties</b> (2)	100%	1st side 2 min 2nd side 1½ to 2½ min	<b>Potatoes, Baked</b> (4 medium)	13-19 min	
<b>Hamburger Patties</b> (4)	100%	1st side 2½ min 2nd side 2-3 min	<b>Squash, Summer</b> (1 lb)	3-8 min	
<b>Meat Loaf</b> (1½ lbs)	100%	13-19 min	<b>OTHER</b>		
<b>Chicken Pieces</b> Internal temperature should be 185°F after standing.	100%	6-9 min/lb	<b>FOOD</b>	<b>COOK POWER</b>	<b>TIME</b>
<b>Turkey Breast</b> Internal temperature should be 185°F after standing.	100% then 70%	5 min 8-12 min/lb	<b>Applesauce</b> (4 servings)	100%	7-10 min
<b>Fish Fillets</b> (1 lb)	100%	5-6 min	<b>Baked Apples</b> (4)	100%	4-6 min
<b>Scallops and Shrimp</b> (1 lb)	100%	3½-5½ min	<b>Chocolate</b> (melt 1 square)	50%	1-2 min
<b>VEGETABLES</b> Cook at 100% cook power.			<b>Eggs, Scrambled</b> (2)	100%	1 min 15 sec to 1 min 45 sec
<b>FOOD</b>		<b>TIME</b>	(4)		2-3 min
<b>Beans, Green or Yellow</b> (1 lb)		6-12 min	<b>Hot Cereals</b> (1 serving) (4 servings)	100%	1½-5 min 4½-7 min
<b>Broccoli</b> (1 lb)		6-10 min	<b>Nachos</b> (large plate)	50%	1½-2½ min
<b>Carrots</b> (1 lb)		8-12 min	<b>Water for Beverage</b> (1 cup) (2 cups)	100%	2½-4 min 4½-6 min

## Microwave cooking tips

### Amount of food

- **If you increase or decrease** the amount of food you prepare, the time it takes to cook that food will also change. For example, if you double a recipe, add a little more than half the original cooking time. Check for doneness and, if necessary, add more time in small increments.
- **If you want to cook two meals or containers of food** at the same time, you can do so with the Bi-Level Cooking Rack. For example, you can cook two frozen dinners or reheat two plates of food by placing one on the rack and one under the rack.

### Starting temperature of food

- **The lower the temperature** of the food being put into the microwave oven, the longer it takes to cook. Food at room temperature will be reheated more quickly than food at refrigerator temperature.

### Composition of food

- **Food with a lot of fat and sugar** will be heated faster than food containing a lot of water. Fat and sugar will also reach a higher temperature than water in the cooking process.
- **The more dense the food**, the longer it takes to heat. "Very dense" food like meat takes longer to reheat than lighter, more porous food like sponge cakes.

### Size and shape

- **Smaller pieces of food** will cook faster than larger pieces and same-shaped pieces of food cook more evenly than irregularly-shaped foods.
- **With unevenly shaped foods**, the thinner parts will cook faster than the thicker areas. **Place** the thinner parts of chicken wings and legs in the center of the dish.

### Stirring, turning foods

- **Stirring and turning foods** distributes heat quickly to the center of the dish and avoids overcooking at the outer edges of the food.

### Covering food

#### Cover food to:

- **Reduce** splattering
- **Shorten** cooking times
- **Retain** food moisture

All coverings that allow microwaves to pass through are suitable.

### Releasing pressure in foods

- **Several foods** (for example: baked potatoes, sausages, egg yolks, and some fruits) are tightly covered by a skin or membrane. This can cause the food to burst from steam building up in them during cooking. To relieve the pressure and to prevent bursting, **pierce** these foods before cooking with a fork, cocktail pick, or toothpick.

### Using standing time

- **Always allow food to stand** for a while after cooking. Standing time after defrosting, cooking, or reheating always improves the result since the temperature will then be evenly distributed throughout the food.
- **The length of the standing time** depends on the volume and density of the food. Sometimes it can be as short as the time it takes you to remove the food from the oven and take it to the serving table. However, with larger, denser food, the standing time may be as long as 10 minutes.

### Arranging food

For best results, distribute food evenly on the plate. You can do this in several ways:

- **If you are cooking several items of the same food**, such as baked potatoes, **place** them in a ring pattern for uniform cooking.
- **When cooking foods of uneven shapes or thickness, such as chicken breasts**, **place** the smaller or thinner area of the food towards the center of the dish where it will be heated last.
- **Layer** thin slices of meat on top of each other.
- **When you cook or reheat whole fish**, **score** the skin – this prevents cracking. Shield the tail and head of whole fish with small pieces of foil to prevent overcooking and ensure the foil does not touch the sides of the oven.
- **Do not** let food or container touch the top or sides of the oven. This will prevent possible arcing.

### Using aluminum foil

Metal containers should not be used in a microwave oven. There are, however, some exceptions. If you have purchased food which is prepackaged in an aluminum foil container, then refer to the instructions on the package. When using aluminum foil containers, cooking times may be longer because microwaves will only penetrate the top of the food.

If you use aluminum containers without package instructions, follow these guidelines:

- **Place** container in a glass bowl and add some water so that it covers the bottom of the container, not more than ¼ inch high. This ensures even heating of the container bottom.
- **Always remove** the lid to avoid damage to the oven.
- **Use only** undamaged containers.
- **Do not use** containers taller than ¾ inch.
- **Container must be** half filled.
- **To avoid arcing**, there must be a minimum ¼ inch between the aluminum container and the walls of the oven and also between two aluminum containers.
- **Reheating food** in aluminum foil containers usually takes up to double the time compared to reheating in plastic, glass, china, or paper containers. The time when food is ready will vary a great deal.
- **Let food stand** for 2-3 minutes after heating so that heat is spread evenly throughout container.

### Cooking you should not do in your microwave oven

- **Do not** do canning of foods in the oven. Closed glass jars may explode, resulting in damage to the oven or possible personal injury.
- **Do not** use the microwave oven to sterilize objects (baby bottles, etc.). It is difficult to maintain the high temperature required for safe sterilization.

# Questions and Answers

QUESTIONS	ANSWERS
Can I use a rack in my microwave oven so that I may reheat or cook on two levels at a time?	You can use a rack only if the rack is supplied with your microwave oven. Use of any rack not supplied with the microwave oven can result in poor cooking performance and/or arcing.
Can I use either metal or aluminum pans in my microwave oven?	Useable metal includes aluminum foil for shielding (use small, flat pieces), small skewers, and shallow foil trays (if tray is not taller than $\frac{3}{4}$ inch deep and half filled with food to absorb microwave energy). Never allow metal to touch walls or door. (For more information, see the "Microwave cooking tips" section.)
Sometimes the door of my microwave oven appears wavy. Is this normal?	This appearance is normal and does not affect the operation of your oven.
What are the humming noises that I hear when my microwave oven is operating?	You hear the sound of the transformer when the magnetron tube cycles on.
Why does the dish become hot when I microwave food in it? I thought that this should not happen.	As the food becomes hot it will conduct the heat to the dish. Be prepared to use hot pads to remove food after cooking.
What does "standing time" mean?	"Standing time" means that food should be removed from the oven and covered for additional time to allow it to finish cooking. This frees the oven for other cooking.
Can I pop popcorn in my microwave oven? How do I get the best results?	Yes. Pop packaged microwave popcorn following manufacturer's guidelines or use the preprogrammed POPCORN pad. Do not use regular paper bags. Use the "listening test" by stopping the oven as soon as the popping slows to a "pop" every 1 or 2 seconds. Do not repop unpopped kernels. You can also use special microwave poppers. When using a popper, be sure to follow manufacturer's directions. Do not pop popcorn in glass cookware.
Why does steam come out of the air exhaust vent?	Steam is normally produced during cooking. The microwave oven has been designed to vent this steam out the top vent.

# If You Need Assistance or Service

This section is designed to help you save the cost of a service call. Part 1 of this section outlines possible problems, their causes, and actions you can take to solve each problem. Parts 2 and 3 tell you what to do if you still need assistance or service. When calling our Consumer Assistance Center for help or calling for service, please provide a detailed description of the problem, your appliance's complete model and serial numbers, and the purchase date. (See the "A Note to You" section.) This information will help us respond properly to your request.

## 1. Before calling for assistance ...

Performance problems often result from little things you can find and fix without tools of any kind. Please check the chart below for problems you can fix. It could save you the cost of a service call.

PROBLEM	POSSIBLE CAUSE	SOLUTION
<b>Nothing will operate</b>	The unit is not wired into a live circuit with the proper voltage.	Contact a qualified Whirlpool service technician to wire unit into a live circuit with the proper voltage. (See Installation Instructions.)
	A household fuse has blown or a circuit breaker has tripped.	Replace household fuse or reset circuit breaker.
	The electric company has experienced a power failure.	Check electric company for a power failure.
<b>The microwave oven will not run</b>	You are using the oven as a timer.	Touch TIMER OFF to cancel the Minute Timer.
	The door is not firmly closed and latched.	Firmly close and latch door.
	You did not touch START/ENTER.	Touch START/ENTER.
	You did not follow directions exactly.	Check instructions for the function you are operating.
	An operation that was programmed earlier is still running.	Touch OFF/CANCEL to cancel previous programming.

continued on next page

## IF YOU NEED ASSISTANCE OR SERVICE

PROBLEM	POSSIBLE CAUSE	SOLUTION
<b>Microwave cooking times seem too long</b>	<p>The electric supply to your home or wall outlets is low or lower than normal.</p> <p>The Cook Power is not at the recommended setting.</p> <p>Larger amounts of food need longer cooking times.</p>	<p>Your electric company can tell you if the line voltage is low. Your electrician or service technician can tell you if the outlet voltage is low.</p> <p>Check "Microwave cooking chart" in the "Cooking Guide" section.</p> <p>Allow for more time when cooking more food at one time.</p>
<b>The Display shows a time counting down but the oven is not cooking</b>	<p>The oven door is not closed completely.</p> <p>You have set the controls as a Minute Timer.</p>	<p>Completely close oven door.</p> <p>Touch TIMER OFF to cancel the Minute Timer.</p>
<b>You do not hear the programming tone</b>	<p>The command is not correct.</p>	<p>Re-enter command.</p>
<b>The Display shows "888:88"</b>	<p>There has been a power interruption.</p>	<p>Reset the clock.</p>



**2. If you need assistance ...**

Call the Whirlpool Consumer Assistance Center telephone number. Dial toll-free from anywhere in the U.S.A.:

**1-800-253-1301**

and talk with one of our trained consultants. The consultant can instruct you in how to obtain satisfactory operation from your appliance or, if service is necessary, recommend a qualified service company in your area.

If you prefer, write to:

Whirlpool Brand Home Appliances  
Consumer Assistance Center  
c/o Correspondence Dept.  
2000 North M-63  
Benton Harbor, MI 49022-2692

Please include a daytime phone number in your correspondence.

**3. If you need service ...**



Whirlpool has a nationwide network of authorized Whirlpool service companies.

Whirlpool service technicians are trained to fulfill the product warranty and provide after-warranty service, anywhere in the United States. To locate the authorized Whirlpool service company in your area, call our Consumer Assistance Center telephone number (see Step 2) or look in your telephone directory Yellow Pages under:

**• APPLIANCE-HOUSEHOLD-MAJOR, SERVICE & REPAIR**

- See: Whirlpool Appliances or Authorized Whirlpool Service  
(Example: XYZ Service Co.)

**• WASHING MACHINES & DRYERS, SERVICE & REPAIR**

- See: Whirlpool Appliances or Authorized Whirlpool Service  
(Example: XYZ Service Co.)

**4. If you are not satisfied with how the problem was solved ...**

- Contact the Major Appliance Consumer Action Program (MACAP). MACAP is a group of independent consumer experts that voices consumer views at the highest levels of the major appliance industry.
- Contact MACAP only when the dealer, authorized servicer, and Whirlpool have failed to resolve your problem.

Major Appliance Consumer Action Program  
20 North Wacker Drive  
Chicago, IL 60606

- MACAP will in turn inform us of your action.

# WHIRLPOOL®

## Microwave Oven Warranty

LENGTH OF WARRANTY	WHIRLPOOL WILL PAY FOR
<b>FULL ONE-YEAR WARRANTY</b> FROM DATE OF PURCHASE	FSP® replacement parts and repair labor to correct defects in materials or workmanship. Service must be provided by an authorized Whirlpool service company.
<b>LIMITED FOUR-YEAR WARRANTY</b> SECOND THROUGH FIFTH YEAR FROM DATE OF PURCHASE	FSP replacement magnetron tube on microwave ovens if defective in materials or workmanship.
<b>WHIRLPOOL WILL NOT PAY FOR</b>	
<p><b>A.</b> Service calls to:</p> <ol style="list-style-type: none"> <li>1. Correct the installation of your microwave oven.</li> <li>2. Instruct you how to use your microwave oven.</li> <li>3. Replace house fuses or correct house wiring.</li> <li>4. Replace owner-accessible light bulbs.</li> </ol> <p><b>B.</b> Repairs when your microwave oven is used in other than normal, single-family household use.</p> <p><b>C.</b> Pickup and delivery. Your microwave oven is designed to be repaired in the home.</p> <p><b>D.</b> Damage to your microwave oven caused by accident, misuse, fire, flood, acts of God, or use of products not approved by Whirlpool.</p> <p><b>E.</b> Any labor costs during limited warranty.</p> <p><b>F.</b> Repairs to parts or systems caused by unauthorized modifications made to the appliance.</p>	

3/96

**WHIRLPOOL CORPORATION SHALL NOT BE LIABLE FOR INCIDENTAL OR CONSEQUENTIAL DAMAGES.** Some states do not allow the exclusion or limitation of incidental or consequential damages, so this exclusion or limitation may not apply to you. This warranty gives you specific legal rights, and you may also have other rights which vary from state to state.

**Outside the United States, a different warranty may apply. For details, please contact your authorized Whirlpool dealer.**

If you need service, first see the "If You Need Assistance or Service" section of this book. After checking "If You Need Assistance or Service," additional help can be found by calling our Consumer Assistance Center telephone number, **1-800-253-1301**, from anywhere in the U.S.A.