

IMPORTANT SAFETY NOTICE

The information provided herein is designed to assist qualified repair personnel only. Untrained persons should not attempt to make repairs due to the possibility of electrical shock. Disconnect power cord before servicing.

IMPORTANT

If any green grounding wires are moved during servicing, they must be returned to their original position and properly secured.

CAUTION

System parts must be removed from cabinet before brazing. All electrical parts and wiring must be shielded from torch flame. Do not allow torch to contact insulation; it will char at 200°F and flash ignite (burn) at 500°F. Excessive heat will distort the plastic liner.

SERVICE DATA SHEET - 218905001

R134a

ICE & WATER - AUTOMATIC DEFROST
SIDE BY SIDE MODELS

PERFORMANCE DATA NO LOAD AND NO DOOR OPENINGS AT MID-POINT CONTROL SETTING				
Type A With Run/Start Capacitor	65°F Ambient	90°F Ambient		
Operating Time	37 to 45%	60 to 68%		
Freezer Temperature	0° to 4°F	-2° to 3°F		
Refrigerator Temperature	34° to 39°F	34° to 39°F		
Low Side Pressure (cut-in)	5 to 12 psig	5 to 12 psig		
Low Side Pressure (cut-out)	-2 to 2 psig	-2 to 2 psig		
High Side Pressure (Last 1/3 of cycle)	110 to 130 psig	150 to 180 psig		
Wattage (Last 1/3 of cycle)	170 to 200	180 to 210		
Amps (Running)	1.5 to 1.8	1.5 to 1.8		
Base Voltage	115 VAC	115 VAC		
DEFROST SPECIFICATIONS				
Cabinet Size	Thermostat		Heater	
	Cut-in	Cut-out	Watts	Ohms
22' to 28'	+25°F	+47°F	600	22
Defrost 30 Minutes Every 8 Hours of Compressor Run Time				
CONDENSER FAN MOTOR				
Watts	RPM		Amps	
2.3	1300 CW Opposite Shaft		.15 Running	
THERMOSTATIC DAMPER				
	Full Open		Closed	
	33°F +/- 2°F		22°F +/- 2°F	
ICE MAKER SPECIFICATIONS				
Electrical	115 Volts		60 Hertz	
Thermostat	Opens at 48°F		Closes at 15°F	
Heater Wattage	165			

ICE MAKER INFORMATION

Test Cycling

Remove cover by inserting screwdriver in notch at bottom and prying cover from housing. Use screwdriver to rotate motor gear counterclockwise until holding switch circuit is completed. All components of ice maker should function to complete the cycle.

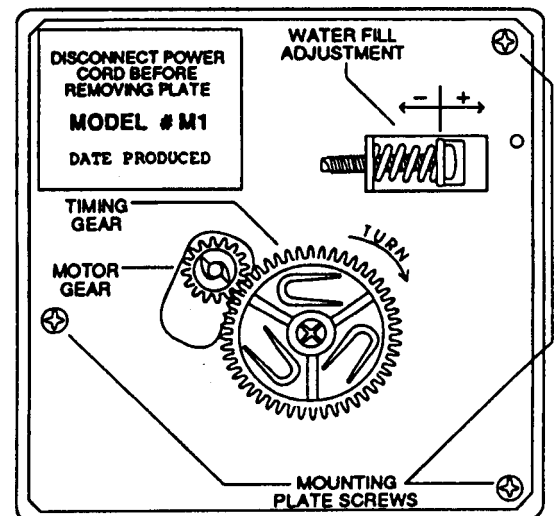

Water Fill Volume

The water fill adjustment screw will change the fill time. One full turn is equal to 20cc (.68 oz.). The correct fill is 90 to 120cc (3.0 to 4.0 oz.). When a water valve is replaced, the fill volume must be checked.

SCHEMATIC

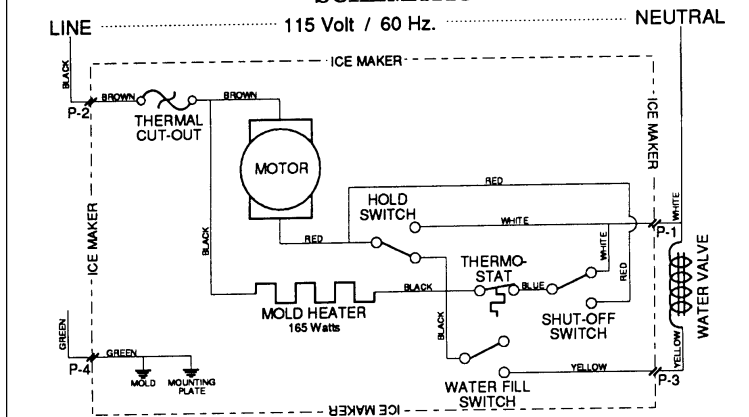

WIRING DIAGRAM

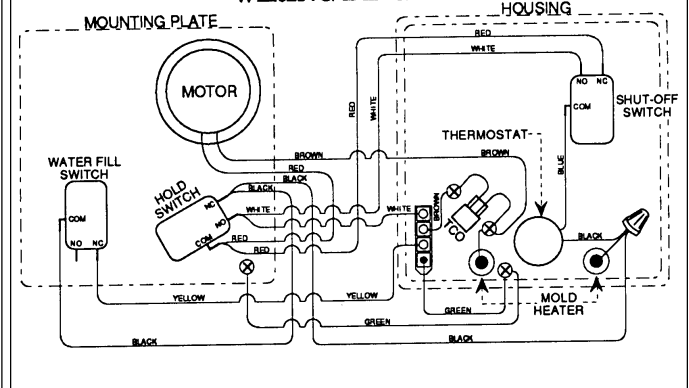

Wiring Diagram

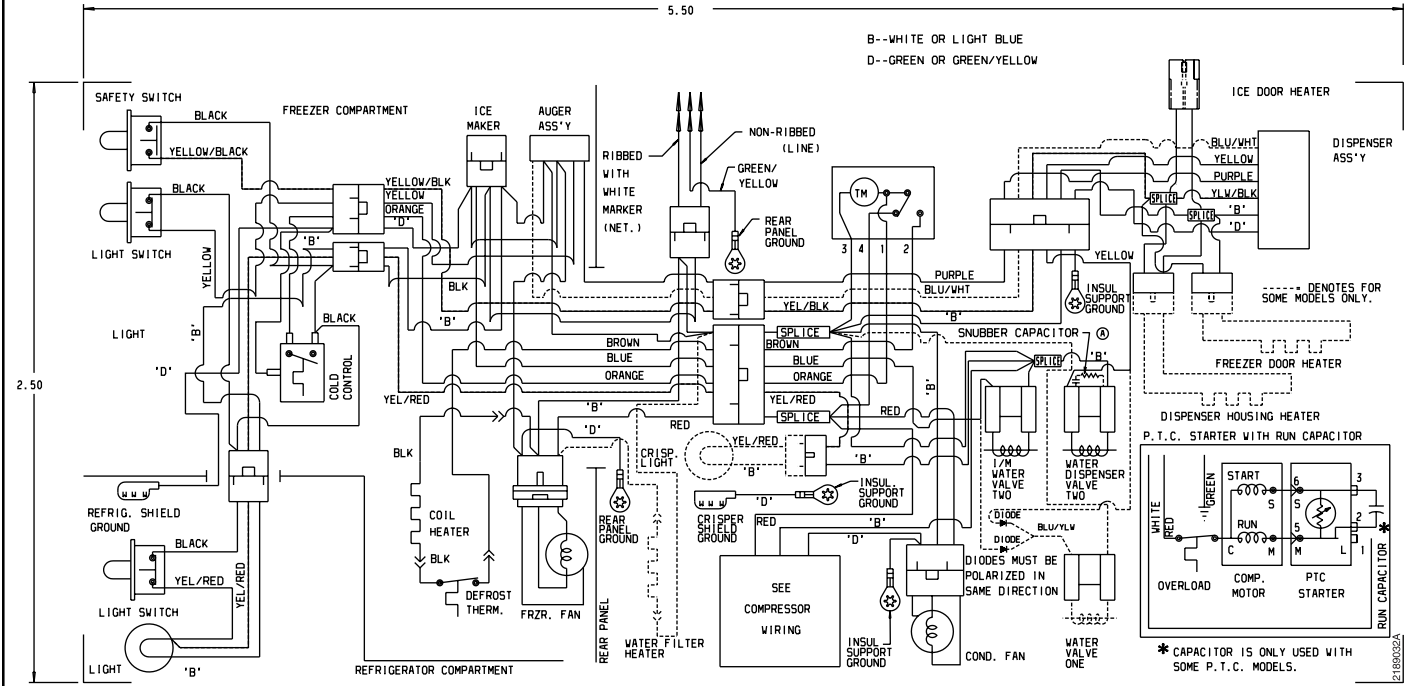

Schematic

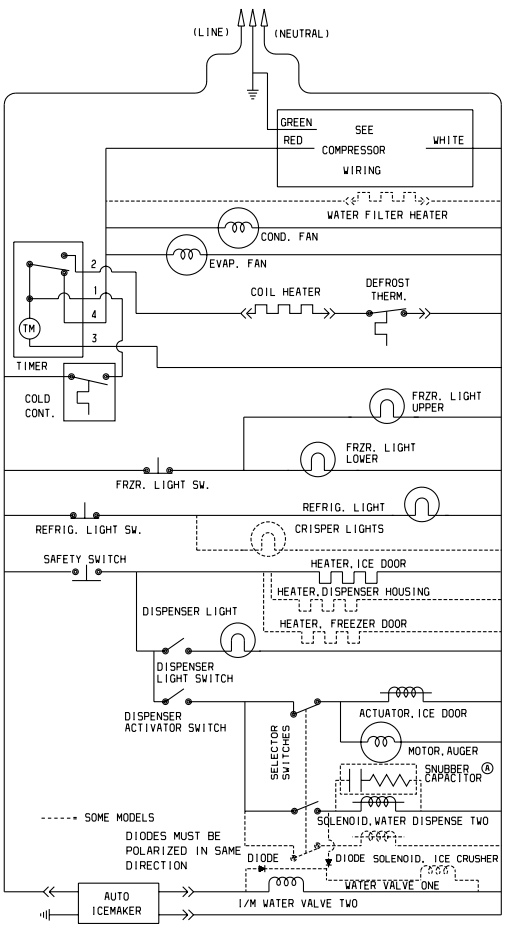

Ice/Water Dispenser

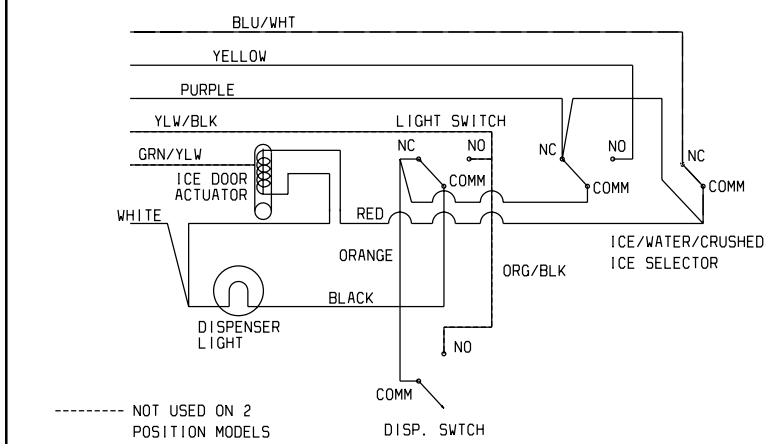

Compressor Terminal Locations

