

OVEN OPERATING TEMPERATURES

Feature	Default	Maximum	Minimum
Bake	350°F/176°C	550°F/288°C	170°F/76°C
Bread proof	HI 100°F/38°C	HI 100°F/38°C	LO 85°F/30°C
Broil	550°F/288°C	550°F/288°C	300°F/148°C
Conv bake	350°F/176°C	550°F/288°C	170°F/76°C
Conv roast	350°F/176°C	550°F/288°C	170°F/76°C
Dehydrate	120°F/48°C	225°F/108°C	100°F/38°C
Keep warm	170°F/76°C	190°F/88°C	150°F/66°C
Rapid preheat	350°F/176°C	550°F/288°C	170°F/76°C

CONTROL LOCK

Step	Press
------	-------

- Choose **CONTROL LOCK** and hold for 3 seconds 

To unlock, press and hold CONTROL LOCK again for 3 seconds.

Control lock will lock oven controls and upper oven door.

DOOR LOCK will flash in the display until the door has finished locking. Once the door has been locked, the door lock indicator will turn on. LOC will then display in the upper cavity only. Do not attempt to open the oven door while DOOR LOCK is flashing.

TIMERS

Step	Press
------	-------

The two timers serve as extra reminders in the kitchen.

To set the timer:

- Choose desired timer
- Enter desired time and press START

To cancel, press the timer key.

OVEN LIGHT

Step	Press
------	-------

- Press **OVEN LIGHT** to turn on lights manually 

The oven lights will automatically turn on when the upper oven door is opened.

ABBREVIATIONS

Code	Explanation	Oven
CIn	Self clean	x
CLO	Setting the clock	x
dEF	Defrost	x
End	End of cycle	x
F10*	Fault code error	x
Hi	Hi setting	x
Hot	Hot oven	x
Lo	Lo setting	x
Loc	Control lock	x
Sab	Sabbath mode	x
Sd	Demo mode	x
Sf	Sabbath mode failure	
CF	Check food	

* F10 is an example of a fault code that you may see. These codes will help your servicer repair your appliance.

LUXURY-GLIDE™ OVEN RACKS

REMOVING GLIDE RACKS

CAUTION

Always use potholders or oven mitts when removing food or adjusting the oven racks. Wait until the oven has completely cooled if possible. Oven racks may be **HOT** and may cause burns.

Use thumbs to press in on both left and right spring-loaded release levers - Fig. 1. Place the remainder of both hands over the upper front of the glide rack. While pressing in on both levers, pull the rack straight out **slightly** and release thumb levers. Using both hands grasp **both the upper and lower portions** of the glide rack (-Fig. 1); pull rack using both hands straight out until reaching the stop position -Fig 2. At the stop, lift up front of rack slightly and continue to pull rack away from oven -Fig 3. Be sure to hold on both upper and lower rack portions when removing from or handling rack outside of the oven - these rack portions move independently and are difficult to handle unless held together

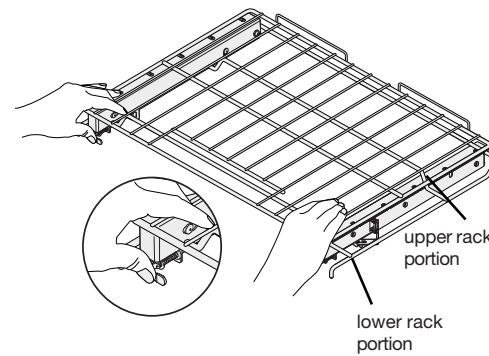

Fig. 1

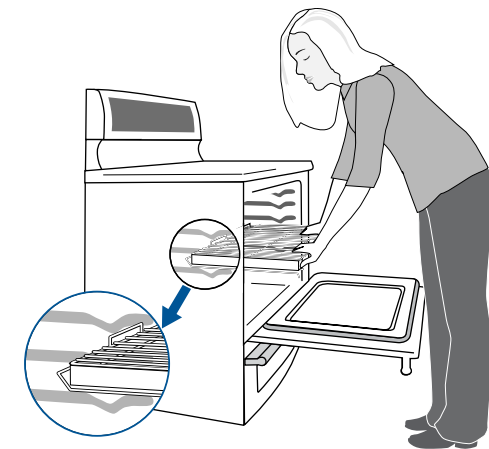

Fig. 2

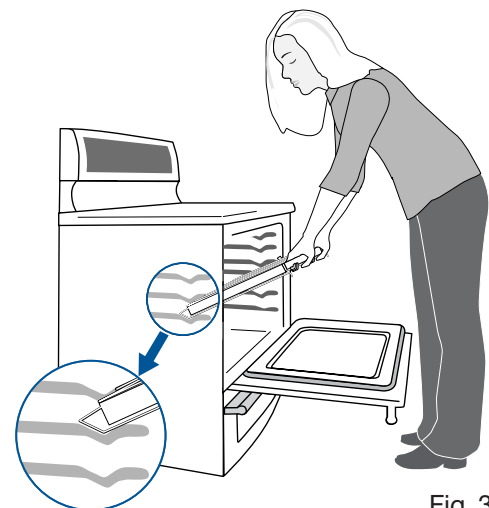
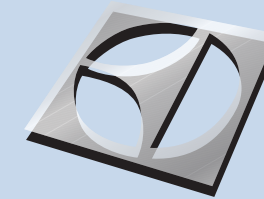

Fig. 3

REPLACING GLIDE RACKS

Grasp **both upper and lower portions** of glide rack, lift and place the rack resting evenly between the oven cavity walls. Tilt the front of the rack upward slightly and slide the rack completely into position. Some force may be necessary to make sure the oven rack has snapped completely back into place.



Quick Reference

30" Free-Standing Gas Range

Thank you for choosing Electrolux, the new premium brand in home appliances. We have provided you with this guide so that you may begin using your appliance right away.

SETTING CLOCK AT POWER UP

You will be prompted to enter the time of day in the event of a power failure or when you first provide power to your appliance.

- When your appliance is first powered up, 12:00 will flash in the display.
- Enter the time of day using the numeric key pads and press **START** to set.

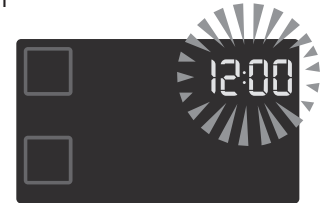

If an invalid time of day is entered, the control will triple beep. Re-enter a valid time of day and press **START**. If **CANCEL** is pressed the clock will start with a time of 12:00.

COOKTOP

GAS BURNER LOCATIONS

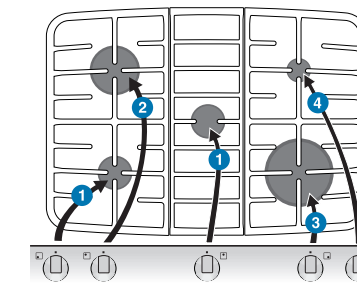

- 2 Standard burners -9,500 BTU- best for most surface cooking requirements.
- Large burner -14,000 BTU- best for bringing large quantities of liquid to boil or when preparing large quantities of food.
- Extra large burner -16,000 BTU- best for bringing large quantities of liquid to boil or when preparing large quantities of food.
- Perfect Simmer™ burner -5,000 BTU- best for simmering delicate sauces, melting chocolates, etc.

OPERATING SINGLE BURNERS

- Push the desired gas surface control knob in and turn counterclockwise out of the OFF position -Fig.1.
- Release knob and rotate to  (lite) position. Visually check that the needed burner has lit.
- To adjust, push the knob in and turn counterclockwise to a flame size setting that best fits your need.

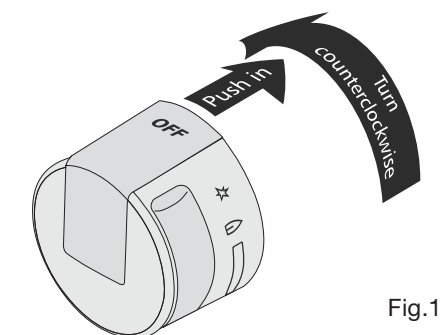

Fig.1

This guide is not intended to replace your user's manual. Refer to the Use & Care Guide for complete instructions.

COOKING OPTIONS

Cook options may be added to cooking features to make your cooking experience easier. The following options are available:

- Cook time
- End time
- Rapid preheat
- Convection convert

COOK TIME

Step	Press
1 Choose UPPER OVEN or WARMER OVEN	UPPER OVEN WARMER OVEN
2 Choose cooking feature	
3 Press START	⏏
4 Press COOK TIME	⌚
5 Enter amount of cooking time	
6 Press START	⏏

RAPID PREHEAT

Step	Press
1 Choose UPPER OVEN	UPPER OVEN
2 Choose cooking feature	
3 Press RAPID PREHEAT	➔➔
4 Press START	⏏

CONVECTION CONVERT

Step	Press
1 Choose UPPER OVEN	UPPER OVEN
2 Choose cooking feature	
3 Press CONV CONVERT	🌀
4 Press START	⏏

USER PREFERENCES

The user preferences key will allow you to customize the way your appliance operates. User pref is only accessible when you are not cooking or using the timers. You will find options such as setting the clock, audio mode and other changes under the user preferences.

COOK TIME WITH END TIME

Step	Press
1 Choose UPPER OVEN or WARMER OVEN	UPPER OVEN WARMER OVEN
2 Choose cooking feature	
3 Press COOK TIME	⌚
4 Enter amount of cooking time	
5 Press END TIME	⌚
6 Enter time of day you wish to stop cooking (00:00 format)	
7 Press START	⏏

COOKING FEATURES

BAKE

Step	Press
1 Press UPPER OVEN	UPPER OVEN
2 Press BAKE*	🍪
3 Press START	⏏

BROIL

Step	Press
1 Place the boiler insert on the broiler pan, then place food on the insert. Remember to follow all warnings and cautions.	
2 Place prepared food directly under broil burner. Close the door.	
3 Press UPPER OVEN	UPPER OVEN
4 Press BROIL*	🔥
5 Press START	⏏

CONV BAKE

Step	Press
1 Press UPPER OVEN	UPPER OVEN
2 Press CONV BAKE*	🌀🍪
3 Press START	⏏

CONV ROAST

Step	Press
1 Press UPPER OVEN	UPPER OVEN
2 Press CONV ROAST*	🌀🍖
3 Press START	⏏

DEHYDRATE

Step	Press
1 Press UPPER OVEN	UPPER OVEN
2 Press DEHYDRATE*	🌿
3 Press START	⏏

*Enter your desired temperature at this point if you choose not to use the default temp.

KEEP WARM

Step	Press
1 Press UPPER OVEN or WARMER OVEN	UPPER OVEN WARMER OVEN
2 Press KEEP WARM*	🔥
3 Press START	⏏

SLOW COOK

Step	Press
1 Press UPPER OVEN	UPPER OVEN
2 Press SLOW COOK	🍲
3 Press -lo for low option. Press +hi for high option.	- lo or + hi
4 Press START	⏏

BREAD PROOF

Step	Press
1 Press UPPER OVEN	UPPER OVEN
2 Press BREAD PROOF Use the + hi or - lo keys to change default temperature.	🍞
3 Press START	⏏

MY FAVORITE (to save)

Step	Press
1 Press UPPER OVEN	UPPER OVEN
2 Choose cooking feature & any other options.	
3 Press START	⏏
4 Press & hold MY FAVORITE for 3 seconds.	📌
5 Press CANCEL	⏏

SELF CLEAN

Step	Press
1 Press UPPER OVEN	UPPER OVEN
2 Choose LITE, MED or HEAVY	🌟 or 🌟 or 🌟
3 Press START	⏏

