



Self-Cleaning Electric Drop-In Ranges

Safety Instructions ... 2-4

Operating Instructions

Clock and Timer10
Controls6, 7
Oven8, 9
Power Outage7
Sabbath Feature13, 14
Self-Cleaning15, 16
Special Features12
Surface Units5
Thermostat14
Timed Baking and
Roasting Features11

Care and Cleaning

Control Knobs17
Drip Pans21
Heating Elements17
Lift-Off Oven Door19
Lift-Up Cooktop21
Light20
Shelves18
Surface Units21
Vent18

*Troubleshooting
Tips* 22-24

Accessories 30

Consumer Support

Consumer
Support Back Cover
Product
Registration 25, 26
Warranty 31

Owner's Manual

JDP39

Write the model and serial numbers here:

Model # _____

Serial # _____

You can find them on a label behind the storage drawer on the front of the range frame.



IMPORTANT SAFETY INFORMATION. READ ALL INSTRUCTIONS BEFORE USING.

⚠ WARNING!

For your safety, the information in this manual must be followed to minimize the risk of fire, electric shock, or to prevent property damage, personal injury, or loss of life.



⚠ WARNING ANTI-TIP DEVICE

All ranges can tip and injury could result.

To prevent accidental tipping of the range, secure the attached Anti-Tip bracket, under the rear countertop. If the Anti-Tip device supplied with the range does not fit this application, use the universal Anti-Tip device WB2X7909.

To check if the device is installed and engaged properly, lower the oven door and gently apply medium force at the handle end until movement of the range is detected. Continue pressing until the anti-tip bracket is engaged and movement stops. A small amount of movement is acceptable at the back of the range top but it should be stable and not tip once the anti-tip bracket is engaged.

If you pull the range out from the wall for any reason, make sure the device is properly engaged when you push the range back against the wall. If it is not, there is a possible risk of the range tipping over and causing injury if you or a child stand, sit or lean on an open door.

Please refer to the Anti-Tip device information shipped with the device and in this manual. Failure to take this precaution could result in tipping of the range and injury.

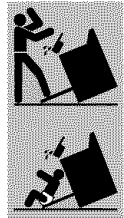

IMPORTANT SAFETY NOTICE

The California Safe Drinking Water and Toxic Enforcement Act requires the Governor of California to publish a list of substances known to the state to cause cancer, birth defects or other reproductive harm, and requires businesses to warn customers of potential exposure to such substances.

The fiberglass insulation in self-clean ovens gives off a very small amount of carbon monoxide during the cleaning cycle. Exposure can be minimized by venting with an open window or using a ventilation fan or hood.



SAFETY PRECAUTIONS

When using electrical appliances, basic safety precautions should be followed, including the following:

- Use this appliance only for its intended purpose as described in this Owner's Manual.
- Do not leave children alone—children should not be left alone or unattended in an area where an appliance is in use. They should never be allowed to sit or stand on any part of the appliance.
- Be sure your appliance is properly installed and grounded by a qualified installer in accordance with the provided installation instructions.
- Do not allow anyone to climb, stand or hang on the door or cooktop. They could damage the range and even tip it over, causing severe personal injury.
- Have the installer show you the location of the circuit breaker or fuse. Mark it for easy reference.
- Large scratches or impacts to glass doors can lead to broken or shattered glass.
- Do not attempt to repair or replace any part of your range unless it is specifically recommended in this manual. All other servicing should be referred to a qualified technician.
- Do not store flammable materials in an oven or near the cooktop.
- Before performing any service, disconnect the range power supply at the household distribution panel by removing the fuse or switching off the circuit breaker.
- **CAUTION:** Items of interest to children should not be stored in cabinets above a range or on the backsplash of a range—children climbing on the range to reach items could be seriously injured.

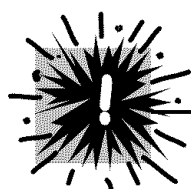

▲ **WARNING!** SAFETY PRECAUTIONS

- Never wear loose-fitting or hanging garments while using the appliance. Be careful when reaching for items stored over the range. Flammable material could be ignited if brought in contact with hot surface units or heating elements and may cause severe burns.
- Use only dry pot holders—moist or damp pot holders on hot surfaces may result in burns from steam. Do not let pot holders touch hot surface units or heating elements. Do not use a towel or other bulky cloth in place of pot holders.
- For your safety, never use your appliance for warming or heating the room.
- Teach children not to play with the controls or any other part of the range.
- Always keep dish towels, dish cloths, pot holders and other linens a safe distance from your range.
- Always keep wooden and plastic utensils and canned food a safe distance from your range.
- Always keep combustible wall coverings, curtains or drapes a safe distance from your range.
- Do not let cooking grease or other flammable materials accumulate in or near the range.
- Keep the hood and grease filters clean to maintain good venting and to avoid grease fires.
- Do not use water on grease fires. Never pick up a flaming pan. Turn the controls off. Smother a flaming pan on a surface unit by covering the pan completely with a well-fitting lid, cookie sheet or flat tray. Use a multi-purpose dry chemical or foam-type fire extinguisher. Flaming grease outside a pan can be put out by covering it with baking soda or, if available, by using a multi-purpose dry chemical or foam-type fire extinguisher. Flame in the oven can be smothered completely by closing the oven door and turning the oven off or by using a multi-purpose dry chemical or foam-type fire extinguisher.
- Do not touch the surface units, the heating elements or the interior surface of the oven. These surfaces may be hot enough to burn even though they are dark in color. During and after use, do not touch, or let clothing or other flammable materials contact the surface units, areas nearby the surface units or any interior area of the oven; allow sufficient time for cooling first. Potentially hot surfaces include the cooktop, areas facing the cooktop, oven vent opening, surfaces near the opening, crevices around the oven door. **REMEMBER:** The inside surface of the oven may be hot when the door is opened.
- Do not store or use combustible materials, gasoline or other flammable vapors and liquids in the vicinity of this or any other appliance.



COOK MEAT AND POULTRY THOROUGHLY...

Cook meat and poultry thoroughly—meat to at least an INTERNAL temperature of 160°F and poultry to at least an INTERNAL temperature of 180°F. Cooking to these temperatures usually protects against foodborne illness.



SURFACE COOKING UNITS

Use proper pan size—select cookware having flat bottoms large enough to cover the surface unit heating element. The use of undersized cookware will expose a portion of the surface unit to direct contact and may result in ignition of clothing. Proper relationship of cookware to surface unit will also improve efficiency.

- Never leave the surface units unattended at high heat settings. Boilovers cause smoking and greasy spillovers that may catch on fire.
- Do not use aluminum foil to line the drip pans or anywhere in the oven, except as described in this manual. Misuse could result in a shock, fire hazard or damage to the range.
- Be sure the drip pans and the vent duct are not covered and are in place. Their absence during cooking could damage range parts and wiring.
- Only certain types of glass, glass/ceramic, earthenware or other glazed containers are suitable for cooktop service; others may break because of the sudden change in temperature. 3

IMPORTANT SAFETY INFORMATION. READ ALL INSTRUCTIONS BEFORE USING.

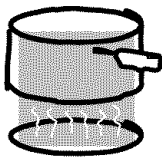

SURFACE COOKING UNITS (cont.)

- To minimize the possibility of burns, ignition of flammable materials and spillage, the handle of a container should be turned toward the center of the range without extending over nearby surface units.
- Always turn the surface units off before removing cookware.
- Do not immerse or soak the removable surface units. Do not put them in a dishwasher. Do not self-clean the surface units in the oven.
- When preparing flaming foods under the hood, turn the fan on.
- To avoid the possibility of a burn or electric shock, always be certain that the controls for all surface units are at the **OFF** position and all coils are cool before attempting to lift or remove a unit.
- Clean the cooktop with caution. If a wet sponge is used to wipe spills on a hot cooktop, be careful to avoid steam burns.
- Keep an eye on foods being fried at high or medium high heat settings.
- Foods for frying should be as dry as possible. Frost on frozen foods or moisture on fresh foods can cause hot fat to bubble up and over the sides of the pan.
- Use little fat for effective shallow or deep fat frying. Filling the pan too full of fat can cause spillovers when food is added.
- If a combination of oils or fats will be used in frying, stir together before heating, or as fats melt slowly.
- Always heat fat slowly, and watch as it heats.
- Use a deep fat thermometer whenever possible to prevent overheating fat beyond the smoking point.



⚠ WARNING!

OVEN

Stand away from the range when opening the oven door. Hot air or steam which escapes can cause burns to hands, face and/or eyes.

- Do not heat unopened food containers. Pressure could build up and the container could burst, causing an injury.
- Keep the oven vent unobstructed.
- Keep the oven free from grease buildup.
- Place the oven shelf in the desired position while the oven is cool. If shelves must be handled when hot, do not let pot holder contact the heating elements.
- Pulling out the shelf to the stop-lock is a convenience in lifting heavy foods. It is also a precaution against burns from touching hot surfaces of the door or oven walls.
- When using cooking or roasting bags in the oven, follow the manufacturer's directions.
- Do not use the oven to dry newspapers. If overheated, they can catch on fire.
- Do not use the oven for a storage area. Items stored in an oven can ignite.
- Do not leave paper products, cooking utensils or food in the oven when not in use.
- Do not use aluminum foil to line oven bottoms. Improper installation of aluminum foil may result in a risk of electric shock or fire.

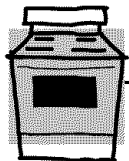

SELF-CLEANING OVEN

Do not use oven cleaners. No commercial oven cleaner or oven liner protective coating of any kind should be used in or around any part of the oven. Residue from oven cleaners will damage the inside of the oven when the self-clean cycle is used.

- Do not clean the door gasket. The door gasket is essential for a good seal. Care should be taken not to rub, damage or move the gasket.
- Before self-cleaning the oven, remove shiny, silver-colored oven shelves (on some models) and all other cookware.
- Be sure to wipe up excess spillage before starting the self-cleaning operation.
- If the self-cleaning mode malfunctions, turn the oven off and disconnect the power supply. Have it serviced by a qualified technician.
- Clean only parts listed in this Owner's Manual.



READ AND FOLLOW THIS SAFETY INFORMATION CAREFULLY.

SAVE THESE INSTRUCTIONS

Using the surface units.

ge.com

Throughout this manual, features and appearance may vary from your model.

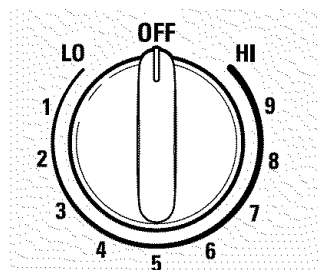

Be sure you turn the control knob to OFF when you finish cooking.

How to Set

Push the knob in and turn in either direction to the setting you want.

At both **OFF** and **HI** the control **clicks** into position. You may hear slight **clicking** sounds during cooking, indicating the control is maintaining your desired setting.

A surface unit **ON** indicator light will glow when **any** surface unit is on.

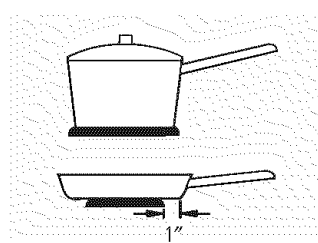

Not over 1 inch.

Surface Cookware Tips

Use medium- or heavy-weight cookware. Aluminum cookware conducts heat faster than other metals. Cast-iron and coated cast-iron cookware are slow to absorb heat, but generally cook evenly at low to medium heat settings. Steel pans may cook unevenly if not combined with other metals.

For best cooking results, pans should be flat on the bottom. Match the size of the saucepan to the size of the surface unit. The pan should not extend over the edge of the surface unit more than 1".

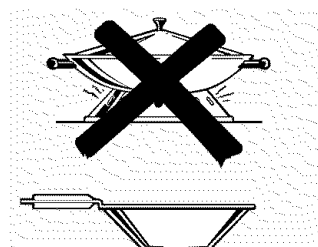

Use only flat-bottomed woks.

Wok Cooking

We recommend that you use only a flat-bottomed wok. They are available at your local retail store.

Do not use woks that have support rings.

Placing the ring over the surface unit will cause a buildup of heat that will damage the porcelain cooktop.

Do not use round bottom woks. You could be seriously burned if the wok tipped over.

Home Canning Tips

Be sure the canner is centered over the surface unit.

Make sure the canner is flat on the bottom.

Use recipes and procedures from reputable sources. These are available from manufacturers such as Ball® and Kerr® and the Department of Agriculture Extension Service.

To prevent burns from steam or heat, use caution when canning.

Safety Instructions

Operating Instructions

Care and Cleaning

Troubleshooting Tips

Consumer Support

Using the oven controls.

Throughout this manual, features and appearance may vary from your model.

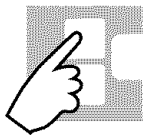
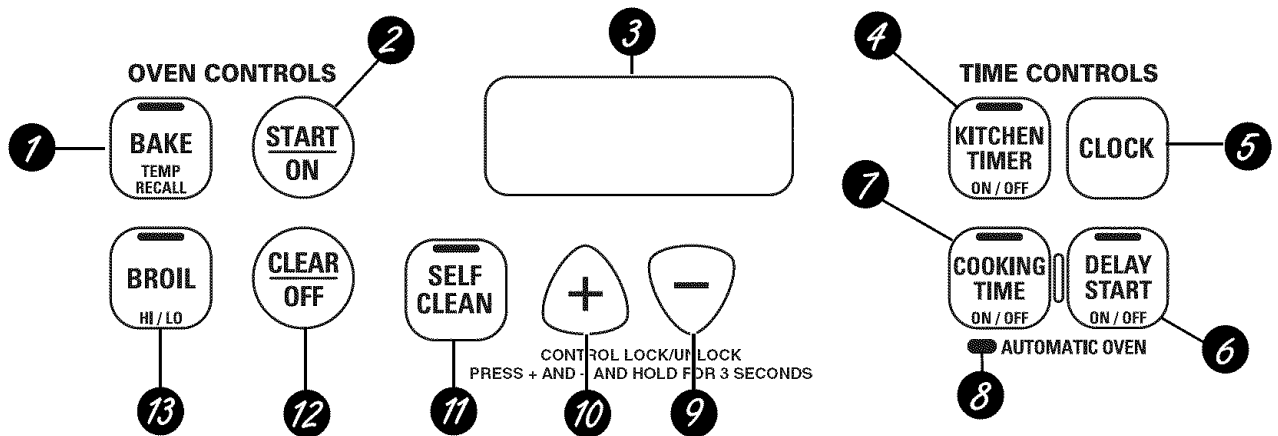

Oven Control, Clock and Timer Features and Settings

- 1** **BAKE/TEMP RECALL Pad**
Touch this pad to select the bake function.

BAKE Light

Flashes while in edit mode—you can change the oven temperature at this point. Glows when the oven is in bake mode.

- 2** **START/ON Pad**
Must be touched to start any cooking or cleaning function.

- 3** **Display**
Shows the time of day, oven temperature, whether the oven is in the bake, broil or self-cleaning mode and the times set for the timer or automatic oven operations. The display will show "PrE" while preheating. When the oven reaches the selected temperature, the oven control will beep and the display will show the oven temperature.

If "F" and a number or letter flash in the display and the oven control signals, this indicates a function error code.

If your oven was set for a timed oven operation and a power outage occurred, the clock and all programmed functions must be reset.

The time of day will flash in the display when there has been a power outage. Reset the clock.

If the function error code appears during the self-cleaning cycle, check the oven door latch. The latch handle may have been moved, even if only slightly, from the latched position. Make sure the latch is moved to the right as far as it will go.

Touch the CLEAR/OFF pad. Allow the oven to cool for one hour. Put the oven back into operation. If the function error code repeats, disconnect the power to the range and call for service.

- 4** **KITCHEN TIMER ON/OFF Pad**
Touch this pad to select the timer feature. Then press + and – pads to adjust time.

TIMER Light

Flashes while in edit mode—you can change the set time at this point. Glows when the timer has been activated. Flashes again when the time has run out until the control is reset.

- 5** **CLOCK Pad**
To set the clock, press this pad twice and then press the + and – pads. The time of day will flash in the display when the oven is first turned on.

- 6** **DELAY START Pad**
Use along with the **COOKING TIME** or **SELF CLEAN** pads to set the oven to start and stop automatically at a time you set.

DELAY START Time Light

Flashes while in edit mode—you can change the delay start set time at this point. Glows when the function has been activated.

- 7** **COOKING TIME Pad**
Touch this pad and then touch the + or – pads to set the amount of time you want your food to cook. The oven will shut off when the cooking time has run out.

COOKING TIME Light

Flashes while in edit mode—you can change the set time at this point. Glows when the function has been activated. Flashes again when the time has run out until the control is reset.

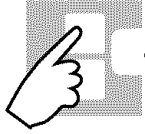

Oven Control, Clock and Timer Features and Settings

- 8** **AUTOMATIC OVEN Light**
This lights anytime the oven has been programmed using the **COOKING TIME** or **DELAY START** functions.
- 9** **- Pad**
Short taps to this pad will decrease the time or temperature by small amounts. Touch and hold the pad to decrease the time or temperature by larger amounts.
- 10** **+ Pad**
Short taps to this pad will increase the time or temperature by small amounts. Touch and hold the pad to increase the time or temperature by larger amounts.
- 11** **SELF CLEAN Pad**
Touch this pad to select the self-cleaning function. See the *Using the self-cleaning oven* section.
- CLEAN Light**
Flashes while in edit mode—you can change the length of time for the self-clean cycle at this point. Glows when the oven is in the self-clean cycle. After the self-clean cycle, the light will turn off. Unlatch the door.
- 12** **CLEAR/OFF Pad**
Touch this pad to cancel **ALL** oven operations except the clock and timer.
- 13** **BROIL HI/LO Pad**
Touch this pad to select the broil function.
- BROIL Light**
Flashes while in edit mode—you can switch from **HI** to **LO BROIL** at this point. Glows when the oven is in broil mode.
- Indicator Lights (on some pads)**
EDIT mode lasts several seconds after the last pad press. **DELAY START ON/OFF** and **COOKING TIME ON/OFF** will be the only pads lit if either of these options is selected. (Example: **DELAY START** is selected with **BAKE**—the **DELAY START** pad will remain lit until the clock reaches the programmed time, at which point it will turn off and the **BAKE/TEMP RECALL** pad light will light up).

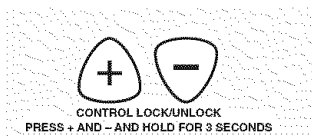

Control Lockout

Your control will allow you to lock out the touch pads so they cannot be activated when touched.

To lock/unlock the controls:

- 1** Touch the **+** and **-** pads at the same time for 3 seconds, until the display shows **LOC ON**.
- 2** To unlock the control, touch the **+** and **-** pads at the same time for 3 seconds, until the display shows **LOC OFF**.

When this feature is on and the touch pads are touched, the control will beep and the display will show **LOC ON**.

- The control lockout mode affects all touch pads. No touch pads will work when this feature is activated.
- The adjustment will be retained in memory after a power failure.

Power Outage

If a flashing time is in the display, you have experienced a power failure. Reset the clock.

To reset the clock, touch the **CLOCK** pad. Enter the correct time of day by touching the **+** or **-** pads. Touch the **START/ON** pad.

Using the oven.

To avoid possible burns, place the shelves in the desired position before you turn the oven on.

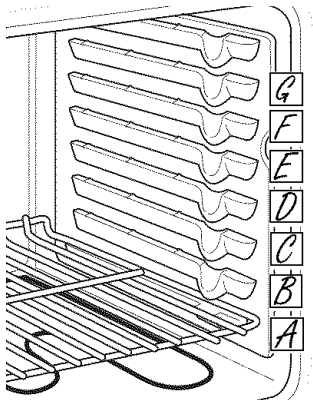

The oven has 7 shelf positions.

Before you begin...

The shelves have stop-locks, so that when placed correctly on the shelf supports (A through G), they will stop before coming completely out, and will not tilt.

When placing and removing cookware, pull the shelf out to the bump on the shelf support.

To remove a shelf, pull it toward you, tilt the front end up and pull it out.

To replace, place the end of the shelf (stop-locks) on the support, tilt up the front and push the shelf in.

CAUTION: When you are using the shelf in the lowest position (A), you will need to use caution when pulling the shelf out. We recommend that you pull the shelf out several inches and then, using two pot holders, pull the shelf out by holding the sides of it. The shelf is low and you could be burned if you place your hand in the middle of the shelf and pull all the way out. Be very careful not to burn your hand on the door when using the shelf in the lowest position (A).

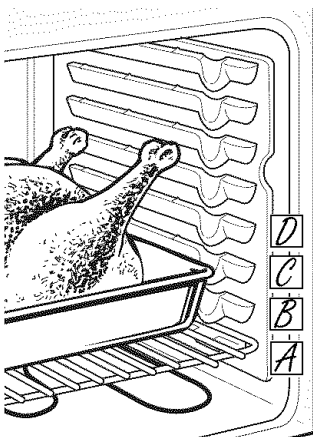

How to Set the Oven for Baking or Roasting

- 1 Touch the **BAKE** pad.
- 2 Touch the **+** or **-** pads until the desired temperature is displayed.
- 3 Touch the **START/ON** pad.

The oven will start automatically. The display will show "PrE" while preheating. When the oven reaches the selected temperature, the oven control will beep several times and the display will show the oven temperature.

To change the oven temperature during **BAKE** cycle, touch the **BAKE** pad and then the **+** or **-** pads to get the new temperature.

- 4 Check food for doneness at minimum time on recipe. Cook longer if necessary.

- 5 Touch the **CLEAR/OFF** pad when baking is finished and then remove the food from the oven.

Type of Food	Shelf Position
Frozen pies (on cookie sheet)	C or D
Angel food cake	A
Bundt or pound cakes	B or C
Biscuits, muffins, brownies, cookies, cupcakes, layer cakes, pies	C or D
Casseroles	C or D
Turkey	A

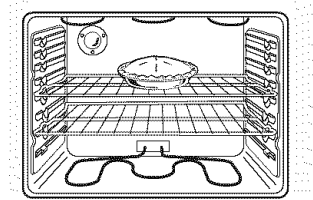

Center baking pans in the oven.

Preheating and Pan Placement

Preheat the oven if the recipe calls for it. Preheating is necessary for good results when baking cakes, cookies, pastry and breads.

The Display will show "PrE" while preheating. When the oven reaches the selected temperature, the oven control will beep and the display will show the oven temperature.

Baking results will be better if baking pans are centered in the oven as much as possible. If baking with more than one pan, place the pans so each has at least 1 to 1½" of air space around it. If baking four cake layers at the same time, place two layers on rack B and two layers on rack D. Stagger pans on the rack so one is not directly above the other.

Aluminum Foil

Do not use aluminum foil on the bottom of the oven.

Never entirely cover a shelf with aluminum foil. This will disturb the heat circulation and result in poor baking.

A smaller sheet of foil may be used to catch a spillover by placing it on a lower shelf several inches below the food.

Do not latch the oven door during broiling. The latch is used for self-cleaning only.

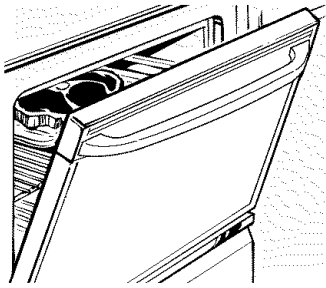

Leave the door open to the broil stop position. The door stays open by itself, yet the proper temperature is maintained in the oven.

How to Set the Oven for Broiling

- 1 Place the meat or fish on a broiler grid in a broiler pan designed for broiling.
- 2 Follow suggested shelf positions in the *Broiling Guide*.
- 3 Touch the **BROIL HI/LO** pad once for HI Broil.
To change to LO Broil, touch the **BROIL HI/LO** pad again.
- 4 Touch the **START/ON** pad.
- 5 When broiling is finished, touch the **CLEAR/OFF** pad.

If your range is connected to 208 volts, rare steaks may be broiled by preheating the broiler and positioning the oven shelf one position higher.

Use **LO Broil** to cook foods such as poultry or thick cuts of meat thoroughly without over-browning them.

The size, weight, thickness, starting temperature and your preference of doneness will affect broiling times. This guide is based on meats at refrigerator temperature.

† The U.S. Department of Agriculture says "Rare beef is popular, but you should know that cooking it to only 140°F means some food poisoning organisms may survive." (Source: *Safe Food Book. Your Kitchen Guide.* USDA Rev. June 1985.)

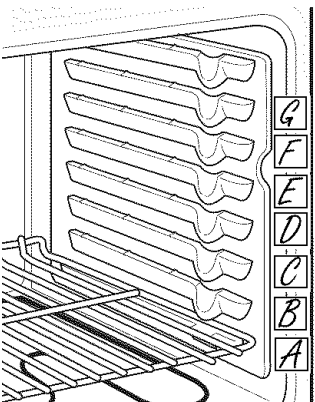

The oven has 7 shelf positions.

Broiling Guide

Food	Quantity and/or Thickness	Shelf Position	First Side Time (min.)	Second Side Time (min.)	Comments
Ground Beef	1 lb. (4 patties)	E	9	6	Space evenly. Up to 8 patties take about the same time.
	Well Done 1/2 to 3/4" thick	E	11	10	
Beef Steaks	Rare† 1" thick	F	7	5	Steaks less than 1" thick cook through before browning. Pan frying is recommended. Slash fat.
	Medium 1 to 1½ lbs.	E	9	6-7	
	Well Done	E	11	8-9	
Rare† Medium Well Done	1½" thick 2 to 2½ lbs.	D	14	11	
		D	18	14-16	
		D	22	20	
Chicken	1 whole cut up 2 to 2½ lbs., split lengthwise	C	25	10	Broil skin-side-down first.
	2 Breasts	C	25	10-15	
Lobster Tails	2-4 10 to 12 oz. each	C	18-20	Do not turn over.	Cut through back of shell. Spread open. Brush with melted butter before broiling and after half of broiling time.
Fish Fillets	1/4 to 1/2" thick	E	6	5	Handle and turn very carefully. Brush with lemon butter before and during cooking, if desired.
Ham Slices (precooked)	1/2" thick	D	6	6	Increase time 5 to 10 minutes per side for 1½" thick or home-cured ham.
Pork Chops	2 (1/2" thick)	E	10	10	Slash fat.
	Well Done 2 (1" thick) about 1 lb.	D	15	15	
Lamb Chops	Medium 2 (1" thick) about 10 to 12 oz.	E	8	7-8	Slash fat.
	Well Done	E	10	9-10	
	Medium 2 (1½" thick) about 1 lb.	E	14	12	
	Well Done	E	17	12-14	
Salmon Steaks	2 (1" thick)	D	10	7-8	Grease pan. Brush steaks with melted butter.
	4 (1" thick) about 1 lb.	D	12	10	

Using the clock and timer.

Not all features are on all models.

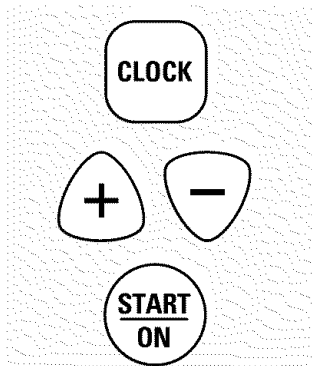

Make sure the clock is set to the correct time of day.

To Set the Clock

The clock must be set to the correct time of day for the automatic oven timing functions to work properly. The time of day cannot be changed during a delayed cooking or a delayed self-cleaning cycle.

- 1 Touch the **CLOCK** pad twice.
- 2 Touch the **+** or **-** pads.

If the **+** or **-** pads are not touched within one minute after you touch the **CLOCK** pad, the display reverts to the original

setting. If this happens, touch the **CLOCK** pad twice and reenter the time of day.

- 3 Touch the **START/ON** pad until the time of day shows in the display. This enters the time and starts the clock.

To check the time of day when the display is showing other information, simply touch the **CLOCK** pad. The time of day shows until another pad is touched.

To Turn Off the Clock Display

If you have several clocks in your kitchen, you may wish to turn off the time of day clock display on your range.

- 1 Touch the **CLOCK** pad once to turn off the time of day display. Although you will not be able to see it, the

clock maintains the correct time of day.

- 2 Touch the **CLOCK** pad twice to recall the clock display.

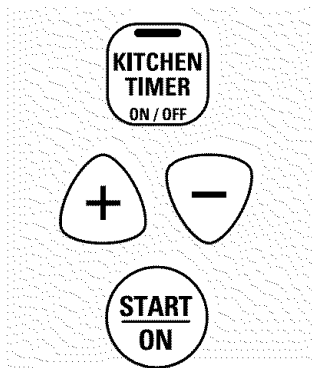

The **CLEAR/OFF** pad does not affect the timer.

To Set the Timer

The timer does not control oven operations. The maximum setting on the timer is 9 hours and 59 minutes.

- 1 Touch the **KITCHEN TIMER ON/OFF** pad.
- 2 Touch the **+** or **-** pads until the amount of time you want shows in the display. The maximum time that can be entered in minutes is 59. Times more than 59 minutes should be changed to hours and minutes.

If you make a mistake, touch the **KITCHEN TIMER ON/OFF** pad and begin again.

- 3 Touch the **START/ON** pad. The time will start counting down, although the display does not change until one minute has passed.
- 4 When the timer reaches **:00**, the control will beep 3 times followed by one beep every 6 seconds until the **KITCHEN TIMER ON/OFF** pad is touched.

To Reset the Timer

If the display is still showing the time remaining, you may change it by touching the **KITCHEN TIMER ON/OFF** pad, then touching the **+** or **-** pads until the time you want appears in the display.

If the remaining time is not in the display (clock, delay start set time or cooking time are in the display), recall the remaining time by touching the **KITCHEN TIMER ON/OFF** pad and then touching the **+** or **-** pads to enter the new time you want.

To Cancel the Timer

Touch the **KITCHEN TIMER ON/OFF** pad twice.

Using the timed baking and roasting features. (on some models)

ge.com

Do not lock the oven door with the latch during timed cooking. The latch is used for self-cleaning only.

NOTE: Foods that spoil easily—such as milk, eggs, fish, stuffings, poultry and pork—should not be allowed to sit for more than 1 hour before or after cooking. Room temperature promotes the growth of harmful bacteria. Be sure that the oven light is off because heat from the bulb will speed harmful bacteria growth.

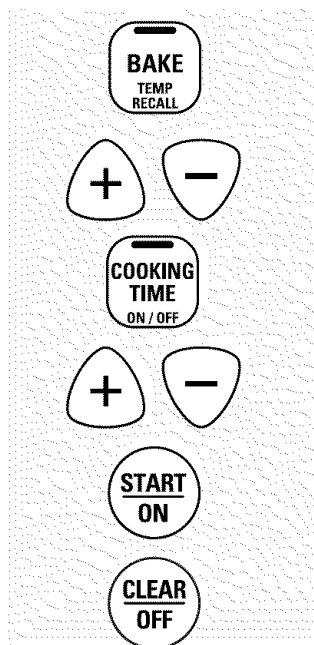

How to Set an Immediate Start and Automatic Stop

The oven will turn on immediately and cook for a selected length of time. At the end of the cooking time, the oven will turn off automatically.

- 1 Touch the **BAKE** pad.
- 2 Touch the **+** or **-** pads to set the oven temperature.
- 3 Touch the **COOKING TIME** pad.

NOTE: If your recipe requires preheating, you may need to add additional time to the length of the cooking time.

- 4 Touch the **+** or **-** pads to set the baking time.

The cooking time that you entered will be displayed. (If you select Cooking Time first and then adjust the Bake Temperature, the oven temperature will be displayed instead).

- 5 Touch the **START/ON** pad.

The display shows either the oven temperature that you set or the cooking time countdown. (The display starts with "PRE" if showing the oven temperature.)

The oven will continue to cook for the programmed amount of time, then turn off automatically.

- 6 Touch the **CLEAR/OFF** pad to clear the display if necessary.

Remove the food from the oven. Remember, even though the oven shuts off automatically, foods continue cooking after controls are off.

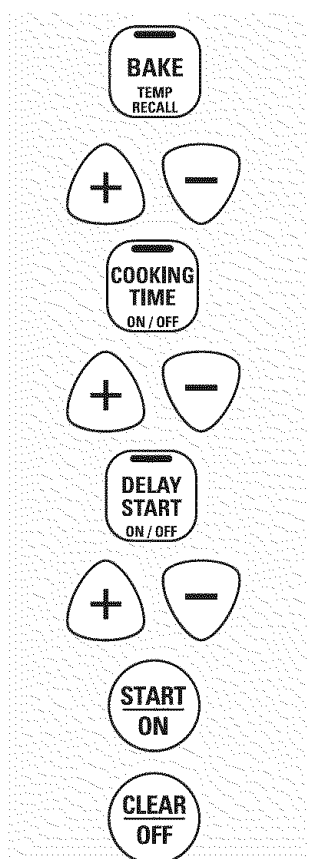

How to Set a Delayed Start and Automatic Stop

The oven will turn on at the time of day you set, cook for a specific length of time and then turn off automatically.

Make sure the clock shows the correct time of day.

- 1 Touch the **BAKE** pad.
- 2 Touch the **+** or **-** pads to set the oven temperature.
- 3 Touch the **COOKING TIME** pad.
- 4 Touch the **+** or **-** pads to set the desired length of cooking time.
- 5 Touch the **DELAY START** pad.
- 6 Touch the **+** or **-** pads to set the time of day you want the oven to turn on and start cooking.
- 7 Touch the **START/ON** pad.

NOTE: An attention tone will sound if you are using timed baking and do not touch the **START/ON** pad.

NOTE: If you would like to check the times you have set, touch the **DELAY START** pad to check the delay start set time you have set or touch the **COOKING TIME** pad to check the length of cooking time you have set.

When the oven turns on at the time of day you have set, the display will show "PRE" until it reaches the selected temperature, then it will display the oven temperature.

At the end of cooking time, the oven will turn off and the end-of-cycle tone will sound.

- 8 Touch the **CLEAR/OFF** pad to clear the display if necessary.

Remove the food from the oven. Remember, even though the oven shuts off automatically, foods continue cooking after controls are off.

Special features of your oven control.

Your new touch pad control has additional features that you may choose to use. The following are the features and how you may activate them.

The special feature modes can only be activated while the display is showing the time of day. They remain in the control's memory until the steps are repeated.

When the display shows your choice, touch the **START/ON** pad. The special features will remain in memory after a power failure.

NOTE: The Sabbath feature and the Thermostat Adjustment feature are also Special Features, but they are addressed separately in the following sections.

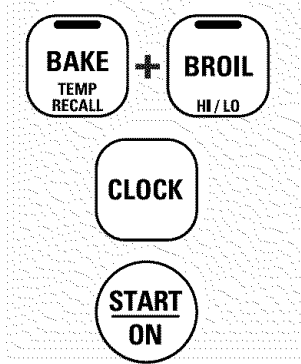

12 Hour Shut-Off

With this feature, should you forget and leave the oven on, the control will automatically turn off the oven after 12 hours during baking functions or after 3 hours during a broil function.

If you wish to turn **OFF** this feature, follow the steps below.

1 Touch the **BAKE** and **BROIL HI/LO** pads at the same time for 3 seconds until the display shows **SF**.

2 Touch the **CLOCK** pad. The display will show **ON** (12 hour shut-off). Touch the **CLOCK** pad repeatedly until the display shows **OFF** (no shut-off).

3 Touch the **START/ON** pad to activate the no shut-off and leave the control set in this special features mode.

Using the Sabbath Feature.

(Designed for use on the Jewish Sabbath and Holidays) (on some models)

ge.com

The Sabbath feature can be used for baking/roasting only. It cannot be used for broiling, self-cleaning or Delay Start cooking.

NOTE: The oven light comes on automatically (on some models) when the door is opened and goes off when the door is closed. The bulb may be removed. See the Oven Light Replacement section. On models with a light switch on the control panel, the oven light may be turned on and left on.

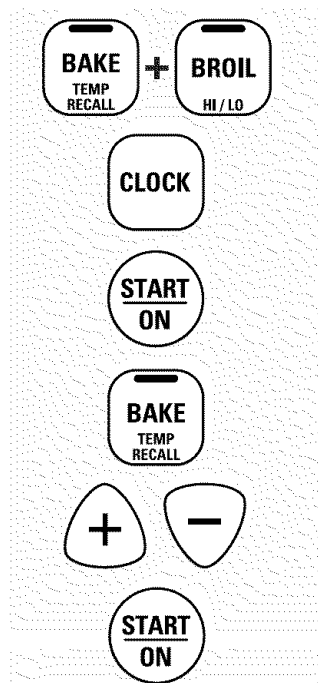

When the display shows \supset the oven is set in Sabbath. When the display shows $\supset \subset$ the oven is baking/roasting.

How to Set for Regular Baking/Roasting

NOTE: To understand how the oven control works, practice using regular baking (non-Sabbath) before entering Sabbath mode.

Make sure the clock shows the correct time of day and the oven is off.

- 1 Touch and hold **both** the **BAKE** and **BROIL HI/LO** pads, **at the same time**, until the display shows **SF**.
- 2 Tap the **CLOCK** pad until **SAb** appears in the display.
- 3 Touch the **START/ON** pad and \supset will appear in the display.
- 4 Touch the **BAKE** pad. No signal will be given.
- 5 The preset starting temperature will automatically be set to 350°. Tap the **+** or **-** pads to increase or decrease the temperature in 25° increments. The temperature can be set between 170° and 550°. No signal or temperature will be given.

- 6 Touch the **START/ON** pad.
- 7 After a random delay period of approximately 30 seconds to 1 minute, $\supset \subset$ will appear in the display indicating that the oven is baking/roasting. If $\supset \subset$ doesn't appear in the display, start again at Step 4.

To adjust the oven temperature, touch the **BAKE** pad and tap the **+** or **-** pads to increase or decrease the temperature in 25° increments. Touch the **START/ON** pad.

NOTE: The **CLEAR/OFF** and **COOKING TIME** pads are active during the Sabbath feature.

To exit Sabbath feature see next page.

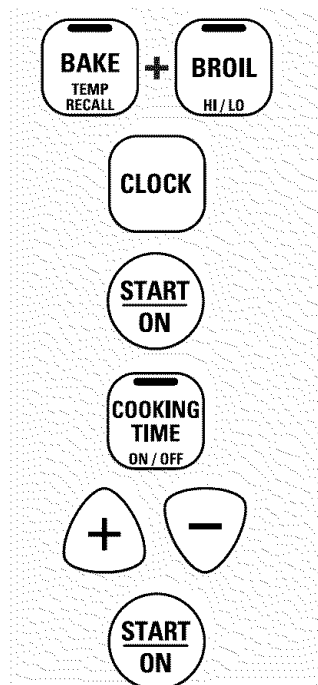

When the display shows \supset the oven is set in Sabbath. When the display shows $\supset \subset$ the oven is baking/roasting.

How to Set for Timed Baking/Roasting—Immediate Start and Automatic Stop

NOTE: To understand how the oven control works, practice using regular (non-Sabbath) Immediate Start and Automatic Stop before entering the Sabbath mode.

Make sure the clock shows the correct time of day and the oven is off.

- 1 Touch and hold **both** the **BAKE** and **BROIL HI/LO** pads, **at the same time**, until the display shows **SF**.
- 2 Tap the **CLOCK** pad until **SAb** appears in the display.
- 3 Touch the **START/ON** pad and \supset will appear in the display.
- 4 Touch the **COOKING TIME** pad.
- 5 Touch the **+** or **-** pads to set the desired length of cooking time between 1 minute and 9 hours and 59 minutes. The cooking time that you entered will be displayed.
- 6 Touch the **START/ON** pad.
- 7 Touch the **BAKE** pad. No signal will be given.

- 8 The preset starting temperature will automatically be set to 350°. Tap the **+** or **-** pads to increase or decrease the temperature in 25° increments. The temperature can be set between 170° and 550°. No signal or temperature will be given.

- 9 Touch the **START/ON** pad.

- 10 After a random delay period of approximately 30 seconds to 1 minute, $\supset \subset$ will appear in the display indicating that the oven is baking/roasting. If $\supset \subset$ doesn't appear in the display, start again at Step 7.

To adjust the oven temperature, touch the **BAKE** pad and tap the **+** or **-** pads to increase or decrease the temperature in 25° increments. Touch the **START/ON** pad.

When cooking is finished, the display will change from $\supset \subset$ to \supset indicating that the oven has turned **OFF** but is still set in Sabbath. Remove the cooked food.

Using the Sabbath Feature.

(Designed for use on the Jewish Sabbath and Holidays) (on some models)

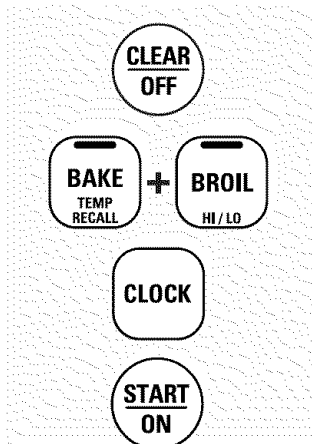

How to Exit the Sabbath Feature

- 1 Touch the **CLEAR/OFF** pad.
- 2 If the oven is cooking, wait for a random delay period of approximately 30 seconds to 1 minute, until only \square is in the display.
- 3 Touch and hold **both** the **BAKE** and **BROIL HI/LO** pads, **at the same time**, until the display shows **SF**.

- 4 Tap the **CLOCK** pad until **ON** or **OFF** appears in the display. **ON** indicates that the oven will automatically turn off after 12 hours. **OFF** indicates that the oven will not automatically turn off. See the *Special Features* section for an explanation of the *12 Hour Shut-Off* feature.

- 5 Touch the **START/ON** pad.

NOTE: If a power outage occurred while the oven was in Sabbath, the oven will automatically turn off and stay off even when the power returns. The oven control must be reset.

Adjust the oven thermostat—Do it yourself!

You may find that your new oven cooks differently than the one it replaced. Use your new oven for a few weeks to become more familiar with it. If you still think your new oven is too hot or too cold, you can adjust the thermostat yourself.

Do not use thermometers, such as those found in grocery stores, to check the temperature setting of your oven. These thermometers may vary 20–40 degrees.

NOTE: This adjustment will not affect the broiling or the self-cleaning temperatures. The adjustment will be retained in memory after a power failure.

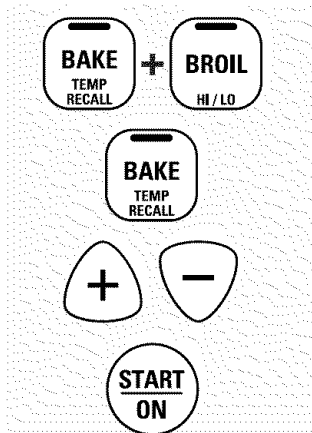

To Adjust the Thermostat

- 1 Touch the **BAKE** and **BROIL HI/LO** pads at the same time for 2 seconds until the display shows **SF**.
- 2 Touch the **BAKE** pad. A two-digit number shows in the display.
- 3 The oven temperature can be adjusted up to (+) 35°F hotter or (–) 35°F cooler. Touch the **+** pad to increase the temperature in 1-degree increments.

Touch the **–** pad to decrease the temperature in 1-degree increments.

- 4 When you have made the adjustment, touch the **START/ON** pad to go back to the time of day display. Use your oven as you would normally.

NOTE: This adjustment will not affect the broiling or self-cleaning temperatures. It will be retained in memory after a power failure.

The type of margarine will affect baking performance!

Most recipes for baking have been developed using high-fat products such as butter or margarine (80% fat). If you decrease the fat, the recipe may not give the same results as with a higher-fat product.

Recipe failure can result if cakes, pies, pastries, cookies or candies are made with low-fat spreads. The lower the fat content of a spread product, the more noticeable these differences become.

Federal standards require products labeled “margarine” to contain at least 80% fat by weight. Low-fat spreads, on the other hand, contain less fat and more water. The high moisture content of these spreads affects the texture and flavor of baked goods. For best results with your old favorite recipes, use margarine, butter or stick spreads containing at least 70% vegetable oil.

Using the self-cleaning oven.

Never force the latch handle. Forcing the handle will damage the door lock mechanism.

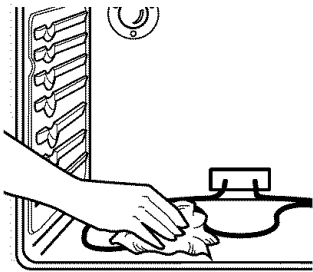

Wipe up heavy soil on the oven bottom.

Before a Clean Cycle

We recommend venting your kitchen with an open window or using a ventilation fan or hood during the first self-clean cycle.

Remove shelves, broiler pan, broiler grid, all cookware and any aluminum foil from the oven.

The shiny, silver-colored oven shelves (on some models) can be self-cleaned, but they will darken, lose their luster and become hard to slide.

Soil on the front frame of the range and outside the gasket on the door will need to be cleaned by hand. Clean these areas with hot water, soap-filled steel wool pads or cleansers such as Soft Scrub®. Rinse well with clean water and dry.

Do not clean the gasket. The fiberglass material of the oven door gasket cannot withstand abrasion. It is essential for the gasket to remain intact. If you notice it becoming worn or frayed, replace it.

Wipe up any heavy spillovers on the oven bottom.

Make sure the oven light bulb cover is in place and the oven light is off.

IMPORTANT: The health of some birds is extremely sensitive to the fumes given off during the self-cleaning cycle of any range. Move birds to another well-ventilated room.

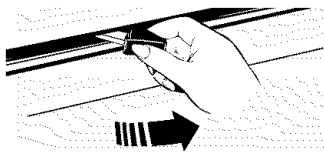

How to Set the Oven for Cleaning

Follow the directions in the *Before a Clean Cycle* section.

1 Latch the door.

NOTE: Never force the latch. If the oven is too hot, you will not be able to slide the latch. Allow the oven to cool.

2 Touch the **SELF CLEAN** pad.

3 Touch the **+** or **-** pads until the desired Clean Time is displayed.

The Clean Time is normally 4 hours. You can change the Clean Time to any time between 3 and 5 hours, depending on the amount of soil in your oven.

4 Touch the **START/ON** pad.

The self-clean cycle will automatically begin after **CLEAN** is displayed and the time countdown appears in the display.

While the oven is self-cleaning, you can touch the **CLOCK** pad to display the time of day. To return to the clean countdown, touch the **SELF CLEAN** pad.

The oven shuts off automatically when the clean cycle is complete, and 0:00 will flash in the display.

5 Slide the latch handle to the left as far as it will go and open the door.

It will not be possible to unlatch the oven door until the temperature drops below the lock temperature and the **LOCKED** door light goes off.

When the **LOCKED** door light is off, unlatch the door.

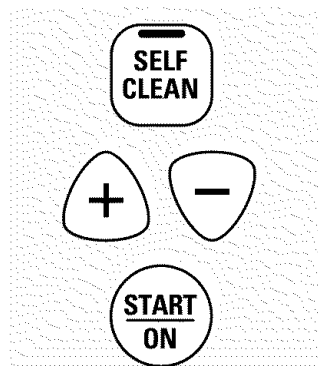

Using the self-cleaning oven.

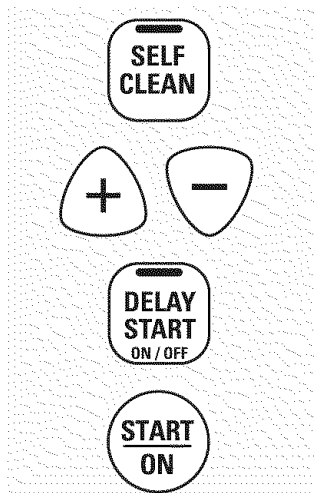
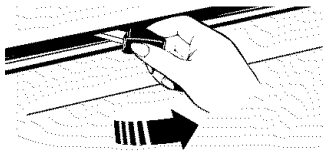

How to Delay the Start of Cleaning

Make sure the clock shows the correct time of day.

- 1 Latch the door.
- 2 Touch the **SELF CLEAN** pad.
- 3 Using the **+** or **-** pads, enter the desired clean time.

The Clean Time is normally 4 hours. You can change the Clean Time to any time between 3 and 5 hours, depending on the amount of soil in your oven.

- 4 Touch the **DELAY START** pad. The earliest delay start time you can set will appear in the display.
- 5 Using the **+** or **-** pads, enter the time of day you want the clean cycle to start.
- 6 Touch the **START/ON** pad.

The display will show the delay start set time. It will not be possible to unlatch the oven door until the temperature drops below the lock temperature and the **LOCKED** door light goes off.

When the **LOCKED** door light is off, unlatch the door.

To Stop a Clean Cycle

Touch the **CLEAR/OFF** pad.

Wait until the oven has cooled below the locking temperature to unlatch the door. You will not be able to open the door right away unless the oven has cooled below the locking temperature.

After a Clean Cycle

You may notice some white ash in the oven. Wipe it up with a damp cloth after the oven cools.

If white spots remain, remove them with a soap-filled scouring pad and rinse thoroughly with a vinegar and water mixture.

These deposits are usually a salt residue that cannot be removed by the clean cycle.

If the oven is not clean after one clean cycle, repeat the cycle.

■ You cannot set the oven for cooking until the oven is cool enough for the door to be unlatched.

■ While the oven is self-cleaning, you can press the **CLOCK** pad to display the time of day. To return to the clean countdown, press the **COOKING TIME** pad.

■ Apply a small amount of vegetable oil to a paper towel and wipe the edges of the oven shelves with the paper towel. Do not spray with Pam® or other lubricant sprays.

Care and cleaning of the range.

ge.com

Be sure all controls are off and all surfaces are cool before cleaning any part of the range.

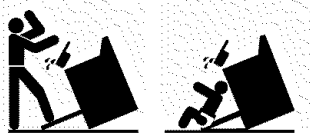

If your range is removed for cleaning, servicing or any reason, be sure the anti-tip device is re-engaged properly when the range is replaced. Failure to take this precaution could result in tipping of the range and cause injury.

How to Remove Protective Shipping Film and Packaging Tape

Carefully grasp a corner of the protective shipping film with your fingers and slowly peel it from the appliance surface. Do not use any sharp items to remove the film. Remove all of the film before using the appliance for the first time.

To assure no damage is done to the finish of the product, the safest way to remove the adhesive from packaging tape on new appliances is an application of a household liquid dishwashing detergent. Apply with a soft cloth and allow to soak.

NOTE: The adhesive must be removed from all parts. It cannot be removed if it is baked on.

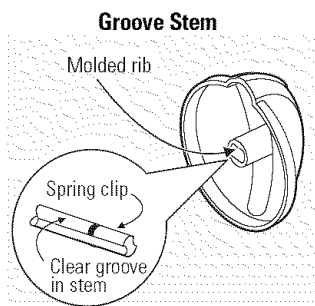

Control Knobs

The control knobs may be removed for easier cleaning.

Make sure the knobs are in the **OFF** positions and pull them straight off the stems for cleaning.

The knobs can be cleaned in a dishwasher or they may also be washed with soap and water. Make sure the insides of the knobs are dry before replacing.

Replace the knobs in the **OFF** position to ensure proper placement.

Control Panel

It's a good idea to wipe the control panel after each use of the oven. Use a damp cloth to clean or rinse. For cleaning, use mild soap and water or a 50/50 solution of vinegar and water. For rinsing, use clean water. Polish dry with a soft cloth.

Do not use abrasive cleansers, strong liquid cleaners, plastic scouring pads or oven cleaners on the control panel—they will damage the finish.

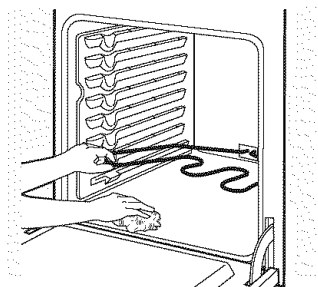

Oven Heating Elements

Do not clean the bake element or the broil element. Any soil will burn off when the elements are heated.

To clean the oven floor, gently lift the bake element. Clean with warm soapy water.

Safety Instructions

Operating Instructions

Care and Cleaning

Troubleshooting Tips

Consumer Support

Care and cleaning of the range.



Oven Shelves

Clean the oven shelves with an abrasive cleanser or steel wool. After cleaning, rinse the shelves with clean water and dry with a clean cloth.

NOTE: The shiny, silver-colored oven shelves (on some models) may be cleaned in the self-cleaning oven. However, the shelves will darken in color, lose their luster and become hard to slide if cleaned during the self-cleaning cycle.

To make the shelves slide more easily, apply a small amount of vegetable oil or cooking oil to a paper towel and wipe the edges of the oven shelves with the paper towel.

Porcelain Enamel Cooktop

The porcelain enamel finish is sturdy but breakable if misused. This finish is acid-resistant. However, any acidic foods spilled (such as fruit juices, tomato or vinegar) should not be permitted to remain on the finish.

If acids spill on the cooktop while it is hot, use a dry paper towel or cloth to wipe it up right away. When the surface has cooled, wash with soap and water. Rinse well.

For other spills such as fat splatterings, wash with soap and water or cleansing powders after the surface has cooled. Rinse well. Polish with a dry cloth.

Painted Surfaces

Painted surfaces include the sides and the drawer front.

Clean these with soap and water or a vinegar and water solution.

Do not use commercial oven cleaners, cleaning powders, steel wool or harsh abrasives on any painted surface.

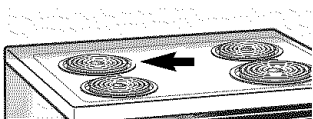

Oven Vent

The oven is vented through an opening under the left rear surface unit.

This area could become hot during oven use.

It is normal for steam to come out of the vent and moisture may collect underneath the coils when the oven is in use.

The vent is important for proper air circulation.

Never block this vent with aluminum foil.

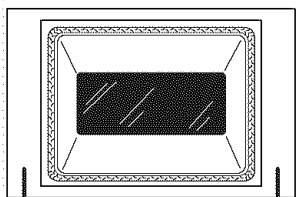

Do not rub or clean the door gasket—it has an extremely low resistance to abrasion.

If you notice the gasket becoming worn, frayed or damaged in any way or if it has become displaced on the door, you should have it replaced.

Cleaning the Oven Door

To clean the inside of the door:

- Because the area inside the gasket is cleaned during the self-clean cycle, you do not need to clean this by hand.
- The area outside the gasket and the door liner can be cleaned with a soap-filled or plastic scouring pad, hot water and detergent. Rinse well with a vinegar and water solution.

To clean the outside of the door:

- Use soap and water to thoroughly clean the top, sides and front of the oven door. Rinse well. You may also use a glass cleaner to clean the glass on the outside of the door. Do not let water drip into the vent openings.

- If any stain on the door vent trim is persistent, use a soft abrasive cleaner and a sponge-scrubber for best results.
- Spillage of marinades, fruit juices, tomato sauces and basting materials containing acids may cause discoloration and should be wiped up immediately. When surface is cool, clean and rinse.
- Do not use oven cleaners, cleaning powders or harsh abrasives on the outside of the door.

Lift-Off Oven Door

The door is very heavy. Be careful when removing and lifting the door.

To remove the door:

- 1 Fully open the door.
- 2 Pull the hinge locks down toward the door frame, to the unlocked position. A tool, such as a small flat-blade screwdriver, may be required.
- 3 Firmly grasp both sides of the door at the top. *Do not lift the door by the handle.*
- 4 Close door to the door removal position, which is halfway between the broil stop position and fully closed.
- 5 Lift door up and out until the hinge arm is clear of the slot.

To replace the door:

- 1 Firmly grasp both sides of the door at the top. *Do not lift the door by the handle.*

- 2 With the door at the same angle as the removal position, seat the notch stop of the hinge arm into the bottom edge of the hinge slot. The notch in the hinge arm must be fully seated into the bottom of the slot.
- 3 Fully open the door until it is parallel to the floor. If the door will not fully open, the notch stop is not seated correctly in the bottom edge of the slot. Repeat step 2 if necessary.
- 4 Push the hinge locks up against the front frame of the oven cavity to the locked position.

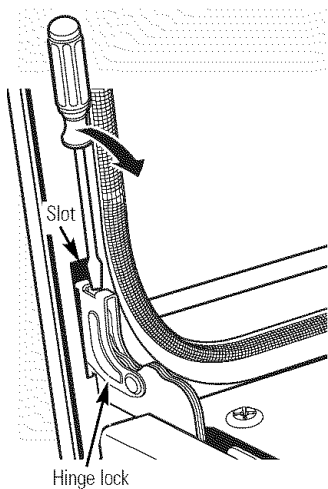

Pull hinge locks down to unlock.

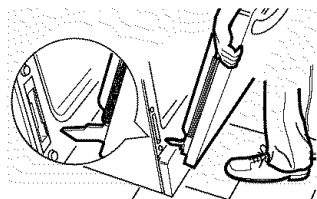

Removal position

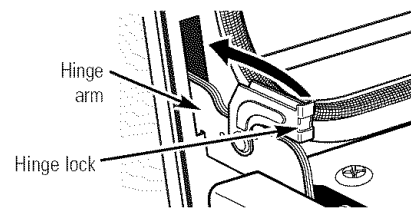

Push hinge locks up to lock.

- 5 Close the oven door.

Care and cleaning of the range.

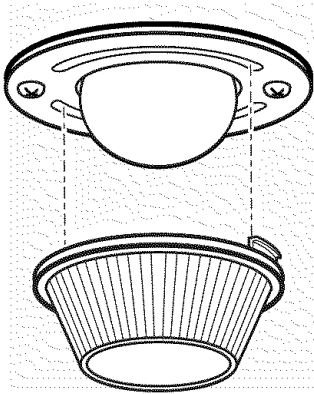

Oven Light Replacement

CAUTION: Before replacing your oven light bulb, disconnect the electrical power to the range at the main fuse or circuit breaker panel.

Be sure to let the light cover and bulb cool completely.

To remove the cover:

- 1 Twist lens counterclockwise about a quarter turn to remove.

Do not remove any screws to remove the cover.

- 2 Replace bulb with a 40-watt appliance bulb or two-prong halogen bulb, as appropriate.

To replace the cover:

- 1 Line up tabs of lens in front of tabs on housing and rotate clockwise to engage.

Be sure the controls are turned to OFF and the surface units are cool before attempting to remove them.

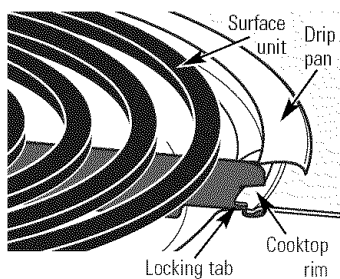

When properly seated, the locking tab should lock onto the cooktop rim through the notch in the drip pan.

Surface Units

To clean the surface units, turn the control to the highest setting for a minute. The coils will burn off any soil.

To remove a surface unit:

To remove the drip pans for cleaning, the surface units must be removed first.

- 1 Push the surface unit back toward the receptacle to free the locking tab from the cooktop.

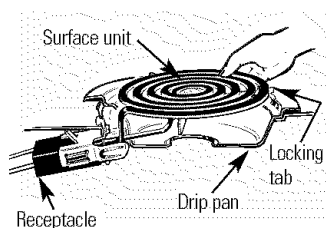

- 2 Lift the surface unit about 1 inch above the drip pan and pull it out.

Do not lift the surface unit more than 1 inch. If you do, it may not lie flat on the drip pan when you plug it back in.

NOTE: Repeated lifting of the surface unit more than 1 inch above the drip pan can permanently damage the receptacle.

To replace a surface unit:

- 1 Replace the drip pan into the recess in the cooktop. Make sure the opening in the pan lines up with the receptacle.
- 2 Insert the terminals of the surface unit through the opening in the drip pan and into the receptacle.

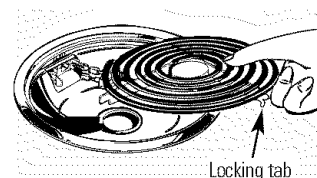

- 3 Push the surface unit in and down to lock the tab in place so it rests evenly in the cooktop.

Do not immerse the surface units in liquids of any kind.

Do not clean the surface units in a dishwasher.

Do not bend the surface unit plug terminals.

Do not attempt to clean, adjust or in any way repair the plug-in receptacle.

Drip Pans

Remove the surface units. Then lift out the drip pans.

Place them in a covered container. Add 1/4 cup ammonia and let soak several hours or overnight. Wash, rinse well and dry.

The drip pans may also be cleaned in a dishwasher.

Clean the area under the drip pans often. Built-up soil, especially grease, may catch fire.

Do not cover the drip pans with foil. Using foil so close to the receptacle could cause shock, fire or damage to the range.

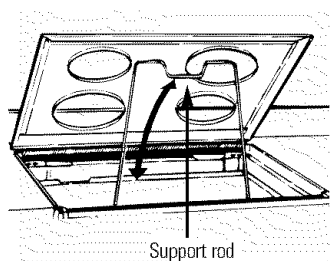

Be sure all surface units are turned off before raising the cooktop.

Lift-Up Cooktop

Clean the area under the cooktop often. Built-up soil, especially grease, may catch fire.

To make cleaning easier, the entire cooktop may be lifted up and supported in the up position.

Be sure all the surface units are turned off before raising the cooktop. The surface units and drip pans do not need to be removed; however, you may remove one to make raising the cooktop easier.

A support rod will hold the cooktop up while you clean underneath it.

After cleaning under the cooktop with hot, soapy water and a clean cloth, lower the cooktop. Be careful not to pinch your fingers.

Before you call for service...



Troubleshooting Tips

Save time and money! Review the charts on the following pages first and you may not need to call for service.

Problem	Possible Causes	What To Do
Surface units do not work properly	The surface units are not plugged in solidly.	<ul style="list-style-type: none"> With the controls off, check to make sure the surface unit is plugged completely into the receptacle.
	The surface unit controls improperly set.	<ul style="list-style-type: none"> Check to see the correct control is set for the surface unit you are using.
	The drip pans are not set securely in the cooktop.	<ul style="list-style-type: none"> With the controls off, check to make sure the drip pan is in the recess in the cooktop and that the opening in the pan lines up with the receptacle.
Control signals after entering cooking time or delay start	You forgot to enter a bake temperature or cleaning time.	<ul style="list-style-type: none"> Press the BAKE pad and desired temperature or the SELF CLEAN pad and desired clean time.
Food does not bake or roast properly	Oven controls improperly set.	<ul style="list-style-type: none"> See the <i>Using the oven</i> section.
	Shelf position is incorrect or the shelf is not level.	<ul style="list-style-type: none"> See the <i>Using the oven</i> section.
	Incorrect cookware or cookware of improper size being used.	<ul style="list-style-type: none"> See the <i>Using the oven</i> section.
	Oven thermostat needs adjustment.	<ul style="list-style-type: none"> See the <i>Adjust the oven thermostat—Do it yourself!</i> section.
Clock and timer do not work	Plug on range is not completely inserted in the electrical outlet.	<ul style="list-style-type: none"> Make sure electrical plug is plugged into a live, properly grounded outlet.
	A fuse in your home may be blown or the circuit breaker tripped.	<ul style="list-style-type: none"> Replace the fuse or reset the circuit breaker.
	Oven controls improperly set.	<ul style="list-style-type: none"> See the <i>Using the clock and timer</i> section.
Oven light does not work	Light bulb is loose or defective.	<ul style="list-style-type: none"> Tighten or replace the bulb.
	Switch operating light is broken.	<ul style="list-style-type: none"> Call for service.
Food does not broil properly	Door not open to the broil stop position as recommended.	<ul style="list-style-type: none"> See the <i>Using the oven</i> section.
	Oven controls improperly set.	<ul style="list-style-type: none"> Make sure you press the BROIL HI/LO pad.
	Improper shelf position being used.	<ul style="list-style-type: none"> See the <i>Broiling Guide</i>.
	Cookware not suited for broiling.	<ul style="list-style-type: none"> For best results, use a pan designed for broiling.
	In some areas the power (voltage) may be low.	<ul style="list-style-type: none"> Preheat the broil element for 10 minutes. Broil for the longest period of time recommended in the <i>Broiling Guide</i>.

Problem	Possible Causes	What To Do
Oven temperature too hot or too cold	Oven thermostat needs adjustment.	<ul style="list-style-type: none"> • See the <i>Adjust the oven thermostat—Do it yourself!</i> section.
Oven will not work	<p>Plug on range is not completely inserted in the electrical outlet.</p> <p>A fuse in your home may be blown or the circuit breaker tripped.</p> <p>Oven controls improperly set.</p> <p>Door left in the locked position.</p>	<ul style="list-style-type: none"> • Make sure electrical plug is plugged into a live, properly grounded outlet. • Replace the fuse or reset the circuit breaker. • See the <i>Using the oven</i> section. • If necessary, allow the oven to cool; then unlock the door.
Oven will not self-clean	<p>The oven temperature is too high to set a self-clean operation.</p> <p>Oven controls improperly set.</p> <p>Oven door is not in the locked position.</p>	<ul style="list-style-type: none"> • Allow the oven to cool to room temperature and reset the controls. • See the <i>Using the self-cleaning oven</i> section. • Make sure you move the door latch handle all the way to the right.
"Crackling" or "popping" sound	This is the sound of the metal heating and cooling during both the cooking and cleaning functions.	<ul style="list-style-type: none"> • This is normal.
Excessive smoking during a clean cycle	Excessive soil.	<ul style="list-style-type: none"> • Press the CLEAR/OFF pad. Open the windows to rid the room of smoke. Wait until the light on the SELF CLEAN pad goes off. Wipe up the excess soil and reset the clean cycle.
Oven door will not unlock	Oven too hot.	<ul style="list-style-type: none"> • Allow the oven to cool below locking temperature.
Oven not clean after a clean cycle	<p>Oven controls not properly set.</p> <p>Oven was heavily soiled.</p>	<ul style="list-style-type: none"> • See the <i>Using the self-cleaning oven</i> section. • Clean up heavy spillovers before starting the clean cycle. Heavily soiled ovens may need to self-clean again or for a longer period of time.

Before you call for service...



Troubleshooting Tips

Problem	Possible Causes	What To Do
"F— and a number or letter" flash in the display	You have a function error code. If the function code repeats.	<ul style="list-style-type: none"> • Press the CLEAR/OFF pad. Put the oven back into operation. • Disconnect all power to the range for at least 30 seconds and then reconnect power. If the function error code repeats, call for service. • On self-cleaning models, if a function error code appears during the self-cleaning cycle, check the oven door latch. The latch may have been moved, if only slightly, from the locked position. Make sure the latch is moved to the right as far as it will go. Press the CLEAR/OFF pad. Allow the oven to cool for one hour. Put the oven back into operation.
Display flashes "bAd" then "linE" with a loud tone	The installed connection from the house to the unit is miswired.	<ul style="list-style-type: none"> • Contact installer or electrician to correct miswire.
Display goes blank	A fuse in your home may be blown or the circuit breaker tripped.	<ul style="list-style-type: none"> • Replace the fuse or reset the circuit breaker.
	The clock is turned off from showing in the display.	<ul style="list-style-type: none"> • See the <i>Using the clock and timer</i> section.
Display flashes	Power failure.	<ul style="list-style-type: none"> • Reset the clock.
Unable to get the display to show "SF"	Oven control pads were not pressed properly.	<ul style="list-style-type: none"> • The BAKE and BROIL HI/LO pads must be pressed at the same time and held for 3 seconds.
Power outage, clock flashes	Power outage or surge.	<ul style="list-style-type: none"> • Reset the clock. If the oven was in use, you must reset it by pressing the CLEAR/OFF pad, setting the clock and resetting any cooking function.
"Burning" or "oily" odor emitting from the vent	This is normal in a new oven and will disappear in time.	<ul style="list-style-type: none"> • To speed the process, set a self-clean cycle for a minimum of 3 hours. See the <i>Using the self-cleaning oven</i> section.
Strong odor	An odor from the insulation around the inside of the oven is normal for the first few times the oven is used.	<ul style="list-style-type: none"> • This is temporary.

GE Service Protection Plus™

GE, a name recognized worldwide for quality and dependability, offers you Service Protection Plus™—comprehensive protection on all your appliances—**No Matter What Brand!**

Benefits Include:

- Backed by GE
- All brands covered
- Unlimited service calls
- All parts and labor costs included
- No out-of-pocket expenses
- No hidden deductibles
- One 800 number to call

***We'll Cover Any Appliance.
Anywhere. Anytime.****

You will be completely satisfied with our service protection or you may request your money back on the remaining value of your contract. No questions asked. It's that simple.

Protect your refrigerator, dishwasher, washer and dryer, range, TV, VCR and much more—**any brand!** Plus there's no extra charge for emergency service and low monthly financing is available. Even icemaker coverage and food spoilage protection is offered. You can rest easy, knowing that all your valuable household products are protected against expensive repairs.

Place your confidence in GE and call us in the U.S. toll-free at **800.626.2224** for more information.

*All brands covered, up to 20 years old, in the continental U.S.



Please place in envelope and mail to:

General Electric Company
Warranty Registration Department
P.O. Box 32150
Louisville, KY 40232-2150

Consumer Product Ownership Registration

Dear Customer:

Thank you for purchasing our product and thank you for placing your confidence in us. We are proud to have you as a customer!

Follow these three steps to protect your new appliance investment:

1

Complete and mail your Consumer Product Ownership Registration today. Have the peace of mind of knowing we can contact you in the unlikely event of a safety modification.

2

After mailing the registration below, store this document in a safe place. It contains information you will need should you require service. Our service number is 800.GE.CARES (800.432.2737).

3

Read your Owner's Manual carefully. It will help you operate your new appliance properly.

Model Number

Serial Number

Important: If you did not get a registration card with your product, detach and return the form below to ensure that your product is registered, or register online at ge.com.

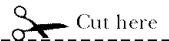

Consumer Product Ownership Registration



Model Number

Serial Number

Mr. Ms. Mrs. Miss

First Name

Last Name

Street Address

Apt. #

E-mail Address*

City

State

Zip Code

Date Placed In Use
Month

Day

Year

Phone Number --

* Please provide your e-mail address to receive, via e-mail, discounts, special offers and other important communications from GE Appliances (GEA).

Check here if you do not want to receive communications from GEA's carefully selected partners.

FAILURE TO COMPLETE AND RETURN THIS CARD DOES NOT DIMINISH YOUR WARRANTY RIGHTS.

For more information about GEA's privacy and data usage policy, go to ge.com and click on "Privacy Policy" or call 800.626.2224.



GE Consumer & Industrial
Appliances
General Electric Company
Louisville, KY 40225
ge.com

Notes.

<i>Safety Instructions</i>	<i>Operating Instructions</i>	<i>Care and Cleaning</i>	<i>Troubleshooting Tips</i>	<i>Consumer Support</i>
----------------------------	-------------------------------	--------------------------	-----------------------------	-------------------------

<i>Consumer Support</i>
<i>Troubleshooting Tips</i>
<i>Care and Cleaning</i>
<i>Operating Instructions</i>
<i>Safety Instructions</i>

Notes.

Notes.

<i>Safety Instructions</i>	<i>Operating Instructions</i>	<i>Care and Cleaning</i>	<i>Troubleshooting Tips</i>	<i>Consumer Support</i>
----------------------------	-------------------------------	--------------------------	-----------------------------	-------------------------

Accessories.

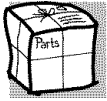

Looking For Something More?

You can find these accessories and many more at ge.com, or call **800.626.2002** (during normal business hours). Have your model number ready.

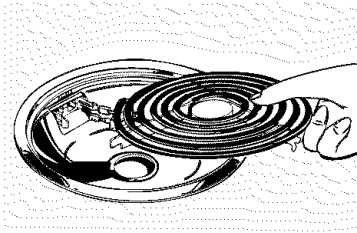

Surface Elements & Drip Pans

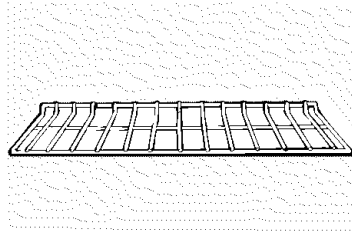

Oven Racks

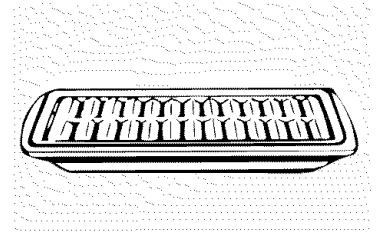

Broiler Pan

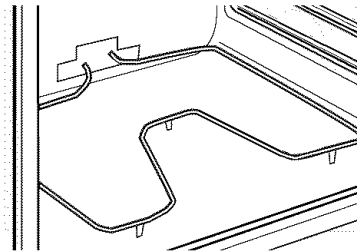

Oven Elements

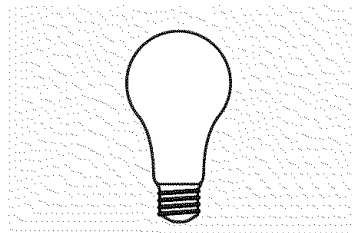

Light Bulbs

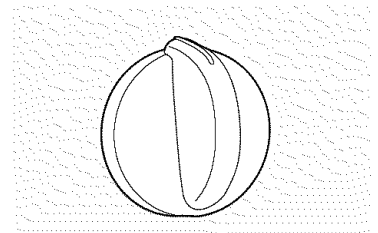

Knobs

Tired of discolored racks? Wishing you had extra-heavy-duty oven racks?

NOW AVAILABLE for your range:

GE's innovative, self-cleanable porcelain-coated oven racks!

- Heavy Duty
- Durable
- Able to be cleaned in a self-cleaning oven

Visit ge.com for more information.

GE Electric Range Warranty.



All warranty service provided by our Factory Service Centers, or an authorized Customer Care[®] technician. To schedule service, on-line, 24 hours a day, visit us at ge.com, or call 800.GE.CARES (800.432.2737). Please have serial number and model number available when calling for service.

Staple your receipt here.
Proof of the original purchase date is needed to obtain service under the warranty.

For The Period Of: GE Will Provide:

One Year

From the date of the original purchase

Any part of the range which fails due to a defect in materials or workmanship. During this **limited one-year warranty**, GE will also provide, **free of charge**, all labor and in-home service to replace the defective part.

What GE Will Not Cover:

- Service trips to your home to teach you how to use the product.
- Improper installation, delivery or maintenance.
- Failure of the product if it is abused, misused, or used for other than the intended purpose or used commercially.
- Replacement of house fuses or resetting of circuit breakers.
- Damage to the product caused by accident, fire, floods or acts of God.
- Incidental or consequential damage caused by possible defects with this appliance.
- Damage caused after delivery.
- Product not accessible to provide required service.

EXCLUSION OF IMPLIED WARRANTIES—Your sole and exclusive remedy is product repair as provided in this Limited Warranty. Any implied warranties, including the implied warranties of merchantability or fitness for a particular purpose, are limited to one year or the shortest period allowed by law.

This warranty is extended to the original purchaser and any succeeding owner for products purchased for home use within the USA. If the product is located in an area where service by a GE Authorized Servicer is not available, you may be responsible for a trip charge or you may be required to bring the product to an Authorized GE Service location for service. In Alaska, the warranty excludes the cost of shipping or service calls to your home.

Some states do not allow the exclusion or limitation of incidental or consequential damages. This warranty gives you specific legal rights, and you may also have other rights which vary from state to state. To know what your legal rights are, consult your local or state consumer affairs office or your state's Attorney General.

Warrantor: General Electric Company, Louisville, KY 40225

Safety Instructions

Operating Instructions

Care and Cleaning

Troubleshooting Tips

Consumer Support

Consumer Support.



GE Appliances Website

ge.com

Have a question or need assistance with your appliance? Try the GE Appliances Website 24 hours a day, any day of the year! For greater convenience and faster service, you can now download Owner's Manuals, order parts or even schedule service on-line.

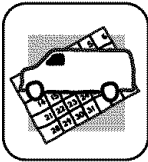

Schedule Service

ge.com

Expert GE repair service is only one step away from your door. Get on-line and schedule your service at your convenience 24 hours any day of the year! Or call 800.GE.CARES (800.432.2737) during normal business hours.

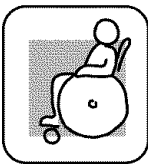

Real Life Design Studio

ge.com

GE supports the Universal Design concept—products, services and environments that can be used by people of all ages, sizes and capabilities. We recognize the need to design for a wide range of physical and mental abilities and impairments. For details of GE's Universal Design applications, including kitchen design ideas for people with disabilities, check out our Website today. For the hearing impaired, please call 800.TDD.GEAC (800.833.4322).



Extended Warranties

ge.com

Purchase a GE extended warranty and learn about special discounts that are available while your warranty is still in effect. You can purchase it on-line anytime, or call 800.626.2224 during normal business hours. GE Consumer Home Services will still be there after your warranty expires.

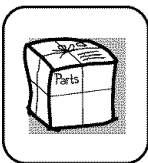

Parts and Accessories

ge.com

Individuals qualified to service their own appliances can have parts or accessories sent directly to their homes (VISA, MasterCard and Discover cards are accepted). Order on-line today, 24 hours every day or by phone at 800.626.2002 during normal business hours.

Instructions contained in this manual cover procedures to be performed by any user. Other servicing generally should be referred to qualified service personnel. Caution must be exercised, since improper servicing may cause unsafe operation.



Contact Us

ge.com

If you are not satisfied with the service you receive from GE, contact us on our Website with all the details including your phone number, or write to: General Manager, Customer Relations
GE Appliances, Appliance Park
Louisville, KY 40225



Register Your Appliance

ge.com

Register your new appliance on-line—at your convenience! Timely product registration will allow for enhanced communication and prompt service under the terms of your warranty, should the need arise. You may also mail in the pre-printed registration card included in the packing material.