



Use & Care Guide

Built-In Wall Oven



 **Electrolux**

Table of contents

Finding information	2
Safety	3-4
Features	5-8
Getting Started	8-9
• Setting clock at power up	8
• Temperature visual display	8
• Oven light	9
• Control lock.....	9
• Setting the kitchen timer	9
Setting oven controls	9-19
• Rapid preheat	9
• Baking.....	10
• Cook time	11
• End time	11
• Broiling.....	12
• Convection baking	13
• Convection roasting	14
• Convection broiling	15
• Convection convert.....	15
• Keep warm	16
• Slow cook	16
• Dehydrating	17
• Bread proof.....	17
• My favorite.....	18
• Sabbath feature	18
Setting your preferences	19-21
• User preferences - Menu.....	19
• Setting the clock - Time of day	20
• Setting clock display - On or off.....	20
• Setting time of day display - 12 or 24 hours	20
• Setting temperature display - F or C.....	20
• Setting continuous bake or 12 hour energy saving...	21
• Audio control.....	21
• Adjusting oven temperature.....	21
• Re-setting to default factory settings	21
Setting starting self-clean	22-23
• Before starting self-clean.....	22
• Setting self-clean	23
• Setting delayed self-clean	23
Care and cleaning	24-26
• Cleaning various parts of your appliance	24
• Special door care instructions	25
• Broiler pan cleaning tips	25
• Changing oven lights.....	25
• To remove and replace oven door	26
Solutions to common problems	27-29
• Baking problems.....	27
• Solutions.....	28-29
Notes	30
Warranty information	31

Please read & save this guide

Thank you for choosing Electrolux, the new premium brand in home appliances. This *Use & Care Guide* is part of our commitment to customer satisfaction and product quality throughout the service life of your new appliance.

We view your purchase as the beginning of a relationship. To ensure our ability to continue serving you, please use this page to record important product information.

Keep a record for quick reference

Purchase date

Electrolux model number

Electrolux serial number

Serial plate location



NOTE

Registering your product with Electrolux enhances our ability to serve you. You can register online at www.electroluxappliances.com or by dropping your Product Registration Card in the mail.

Questions?

For toll-free telephone support in the U.S. and Canada:

1-877-4ELECTROLUX (1-877-435-3287)

For online support and Internet production information visit <http://www.electroluxappliances.com>

What you need to know about safety instructions

Warning and Important Instructions appearing in this guide are not meant to cover all possible conditions and situations that may occur. Common sense, caution and care must be exercised when installing, maintaining or operating a microwave.

ALWAYS contact your dealer, distributor, service agent or manufacturer about problems or conditions you do not understand.

Recognize Safety Symbols, Words, Labels

WARNING

WARNING — Hazards or unsafe practices which **COULD** result in severe personal injury or death.

- **Remove all tape and packaging wrap before using the appliance. Destroy the carton and plastic bags after unpacking the appliance.** Never allow children to play with packaging material. Do not remove the wiring label and other literature attached to the back of the wall oven. Do not remove model/serial number plate.
- **Proper Installation—Be sure your appliance is properly installed and grounded by a qualified electrician or installer in accordance with the National Electrical Code ANSI/NFPA No. 70 (U.S.A.) or CSA C22.1, PART 1 (Canada)—latest editions and local code requirements. Install only per installation instructions provided in the literature package for this appliance.**

Ask your dealer to recommend a qualified technician and an authorized repair service. Know how to disconnect the electrical power to the range at the circuit breaker or fuse box in case of an emergency.

CAUTION

Electronic controllers can be damaged by cold temperatures. When you use your appliance for the first time, or if it has not been used for a long period of time, make sure that it has been exposed to a temperature above 0°C/32°F for at least 3 hours before connecting it to the power supply.

- **User Servicing—Do not repair or replace any part of the appliance unless specifically recommended in the manuals.** All other servicing should be done only by a qualified technician to reduce the risk of personal injury and damage to the appliance.
- **Never modify or alter the construction of a range by removing leveling legs, panels, wire covers, anti-tip brackets/screws, or any other part of the product.**

CAUTION

CAUTION — Hazards or unsafe practices which **COULD** result in minor personal injury.

- Remove the oven door from any unused appliance if it is to be stored or discarded.

WARNING

- **Stepping, leaning or sitting on the door or drawer of this appliance can result in serious injuries and may also cause damage to the appliance.** Do not allow children to climb or play around the appliance. The weight of a child on an open door may cause the appliance to tip, resulting in serious burns or other injury.
- **Do not use the oven for storage.**
- **Storage in or on Appliance—Flammable materials should not be stored in an oven.** This includes paper, plastic and cloth items, such as cookbooks, plasticware and towels, as well as flammable liquids. Do not store explosives, such as aerosol cans, in or near the appliance.

CAUTION

Do not store items of interest to children in the cabinets above an appliance. Children climbing on the oven can be seriously injured.

- Do not leave children alone—Children should not be left alone or unattended in the area where an appliance is in use. They should never be allowed to sit or stand on any part of the appliance.

WARNING

To reduce the risk of tipping of the appliance. The appliance must be secured by properly installed anti tip device. To check if devices are installed properly open the oven door and verify that the anti-tip devices are engaged. See installation instructions.

4 Important Safety Instructions

- **DO NOT TOUCH INTERIOR OVEN ELEMENTS OR INTERIOR SURFACES OF THE WALL OVEN UNTIL THEY HAVE COOLED.** The oven heating elements may be hot even though the elements are dark in color. Areas near the elements may become hot enough to cause burns. During and after use, do not touch, or let clothing or other flammable materials touch these areas until they have had sufficient time to cool. Among these areas are the oven vent openings, the surfaces near these openings, oven door and window.
- **Wear Proper Apparel—**Loose-fitting or hanging garments should never be worn while using the appliance. Do not let clothing or other flammable materials contact hot surfaces.
- **Do Not Use Water or Flour on Grease Fires—**Smother the fire with a pan lid, or use baking soda, a dry chemical or foam-type extinguisher.



WARNING

Never use your appliance for warming or heating the room.

- When heating fat or grease, watch it closely. Fat or grease may catch fire if allowed to become too hot.
- **Use Only Dry Pot holders—**Moist or damp pot holders on hot surfaces may result in burns from steam. Do not let the pot holders touch the hot heating elements. Do not use a towel or other bulky cloth instead of a pot holder.
- **Do Not Heat Unopened Food Containers—**Build-up of pressure may cause the container to burst and result in injury.

IMPORTANT INSTRUCTIONS FOR USING YOUR OVEN

- **Use Care When Opening an Oven Door—**Stand to the side of the appliance when opening the door of a hot oven. Let hot air or steam escape before you remove or replace food in the oven.
- **Keep Oven Vent Ducts Unobstructed.** The wall oven is vented at the upper control panel or at the center trim depending on the model. Touching the surfaces in this area when the wall oven is operating may cause severe burns. Also, do not place plastic or heat-sensitive items near the oven vent. These items could melt or ignite.
- **Placement of Oven Racks.** Always place oven racks in desired location while oven is cool. Remove all utensils from the rack before removing rack. If rack must be moved while oven is hot, use extreme caution. Use pot holders and grasp the rack with both

hands to reposition. Do not let pot holders contact the hot oven element or interior of the oven.

- **Do not use the broiler pan without its insert.** The broiler pan and grid allow dripping fat to drain and be kept away from the high heat of the broiler.
- **Do not cover the broiler grid or oven bottom with aluminum foil.** Exposed fat and grease could ignite.
- **Do not touch a hot oven light bulb with a damp cloth.** Doing so could cause the bulb to break. Disconnect the appliance or shut off the power to the appliance before removing and replacing the bulb.

IMPORTANT INSTRUCTIONS FOR CLEANING YOUR OVEN

- Clean the appliance regularly to keep all parts free of grease that could catch fire. Exhaust fan ventilation hoods and grease filters should be kept clean. Do not allow grease to accumulate. Greasy deposits in the fan could catch fire. Refer to the hood manufacturer's instructions for cleaning.

SELF CLEANING OVENS

- Clean in the self-cleaning cycle only the parts of the appliance listed in this Owner's Guide. Before using the self-cleaning cycle of the appliance, remove the broiler pan, oven racks and any utensils stored in the appliance. Also the side rails of the oven racks must be removed for the self-clean function to operate.
- Do not clean the oven door gasket. The door gasket is essential for a good seal. Care should be taken not to rub, damage or move the gasket.
- Do not use oven cleaners. No oven cleaner or oven liner protective coating of any kind should be used in or around any part of the appliance



CAUTION

The health of some birds is extremely sensitive to the fumes given off during the self-clean cycle of any wall oven. Move birds to another well ventilated room.

Important safety notice

The California Safe Drinking Water and Toxic Enforcement Act requires the Governor of California to publish a list of substances known to the state to cause cancer, birth defects or other reproductive harm, and requires businesses to warn customers of potential exposure to such substances.



NOTE

Save these important safety instructions for future reference.

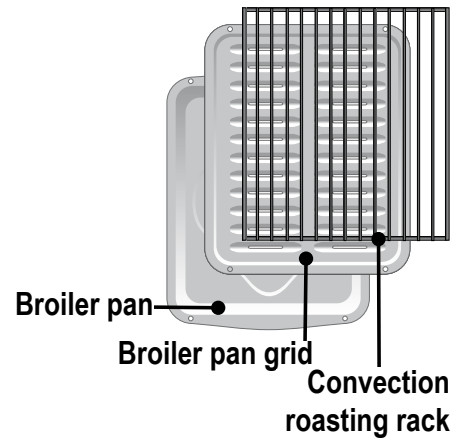
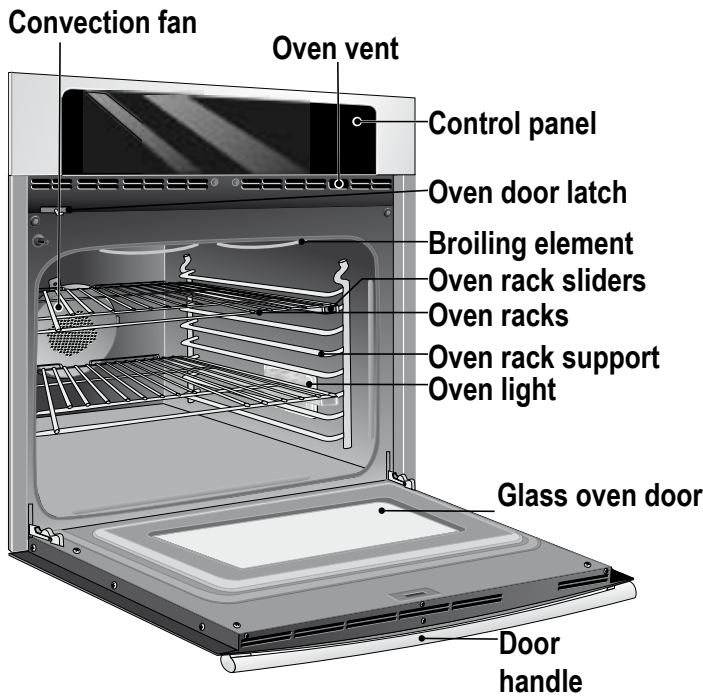

Installing Oven Rack Supports

ALWAYS INSTALL OVEN RACK SUPPORT BEFORE TURNING ON THE OVEN (WHEN THE OVEN IS COOL).

To install oven rack support, insert the supports by pushing them downward into the two brackets on each side of the oven interior, as shown below.

To remove the oven rack support for a self-clean cycle, pull up the support to disengage them from the brackets. If the rack supports are not removed, the self-clean cycle won't start.

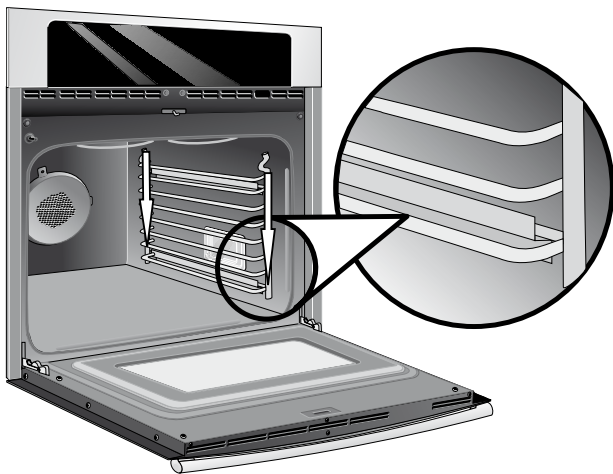

Oven Rack Positions

This oven is equipped with ladder rack supports with 8 positions to accommodate precisely every mode of cooking.

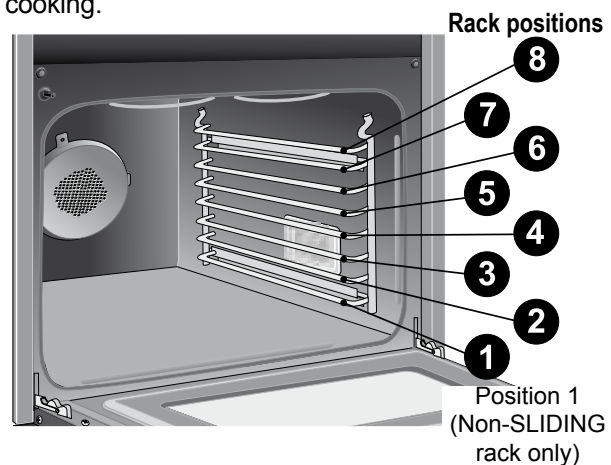

Oven Vents Location

The oven is vented **above each door**. When the oven is on, warm air is released through the vents. This venting is necessary for proper air circulation in the oven and good baking results.

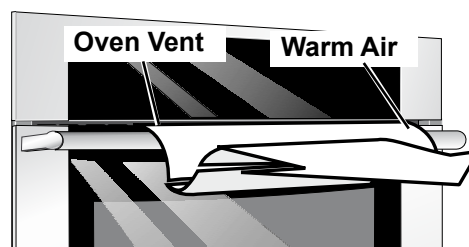

Removing and replacing oven racks

Removing Sliding Oven Racks

1. With the rack in its closed position; grasp the rack and the sliders at once.
2. Slightly lift the rack and sliders and pull it to clear the first bracket.
3. Pull the rack and sliders until the second bracket stops the rack.
4. Lift the rack and sliders and carefully remove them from the oven.

Replacing Sliding Oven Racks

To replace the oven racks, follow the instructions above in reverse order.

Refer to the care and cleaning section for directions on how to clean the racks.

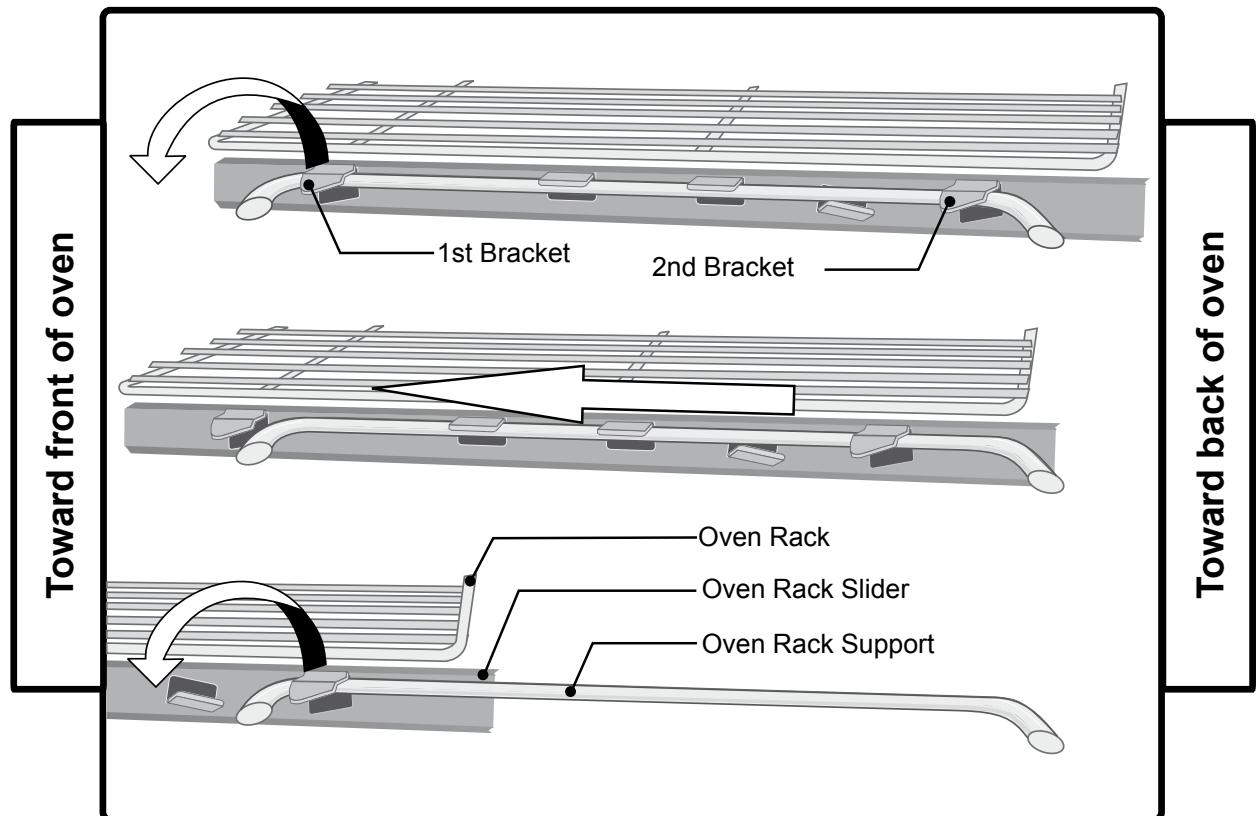

Removing Non-Sliding Oven Rack

Simply pull the rack and slightly tilt it upward when the rack hits its stop position.

Replacing Non-Sliding Oven Rack

Insert the rack into the oven rack supports by inserting the rack openings into the rack supports. Be sure the rack is at the same position on each oven rack support on both sides.

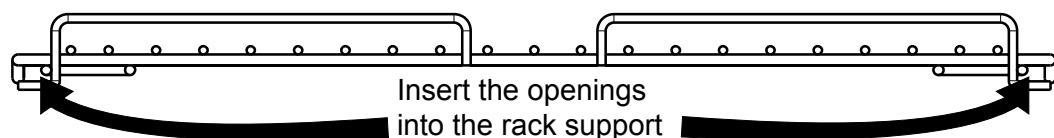

WARNING

Always arrange the oven racks when the oven is cool (prior to operating the oven). Always use oven mitts when using the oven.

Control pad functions

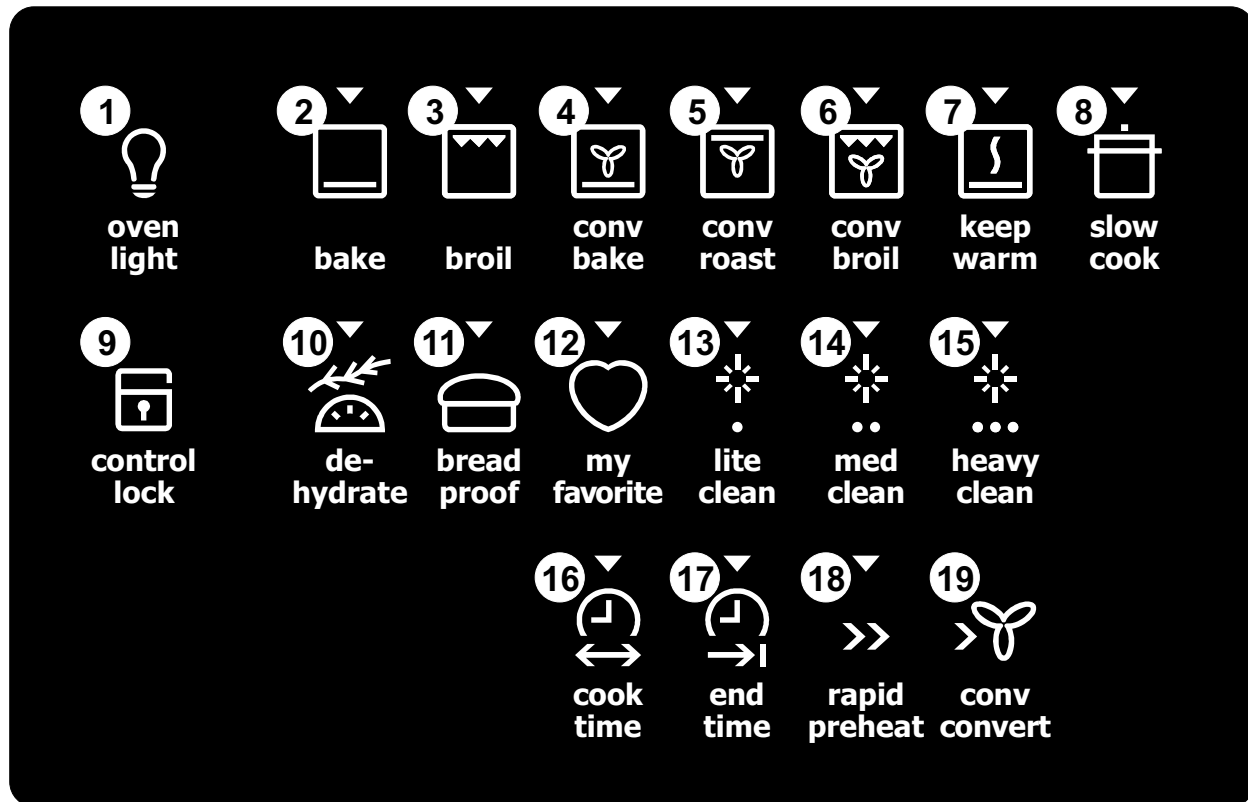

- 1. Light Pad-** Used to turn the oven light on and off (on left or right side depending on your model).
- 2. Bake Pad-** Used to enter the normal baking mode temperature.
- 3. Broil Pad-** Used to select the variable broil mode.
- 4. Convection Bake Pad-** Used to select the convection baking mode.
- 5. Convection Roast Pad-** Used to select the convection roasting mode.
- 6. Convection Broil Pad-** Used to select the convection broil mode.
- 7. Keep Warm Pad-** Used to select the keep warm mode.
- 8. Slow Cook-** Used to select the slow cook mode.
- 9. Control Lock Pad-** Used to disable all oven function (on left or right side depending on your model).
- 10. Dehydrate Pad-** Used to select the dehydrate mode.
- 11. Bread Proof Pad-** Used to select the bread proof mode.
- 12. My Favorite Pad-** Used to save or recall a favorite cooking mode.
- 13. Lite Clean Pad-** Used to start a 2 hours self-clean cycle.
- 14. Med Clean Pad-** Used to start a 3 hours self-clean cycle.
- 15. Heavy Clean Pad-** Used to start a 4 hours self-clean cycle.
- 16. Cook Time Pad-** Used to set a cooking duration time.
- 17. End Time Pad-** Used to select the time at which the cooking will end.
- 18. Rapid Preheat Pad-** Used to preheat the oven to the desired temperature.
- 19. Conv. Convert Pad-** Used to convert a standard temperature to a convection temperature.

8 Features

Control pad functions

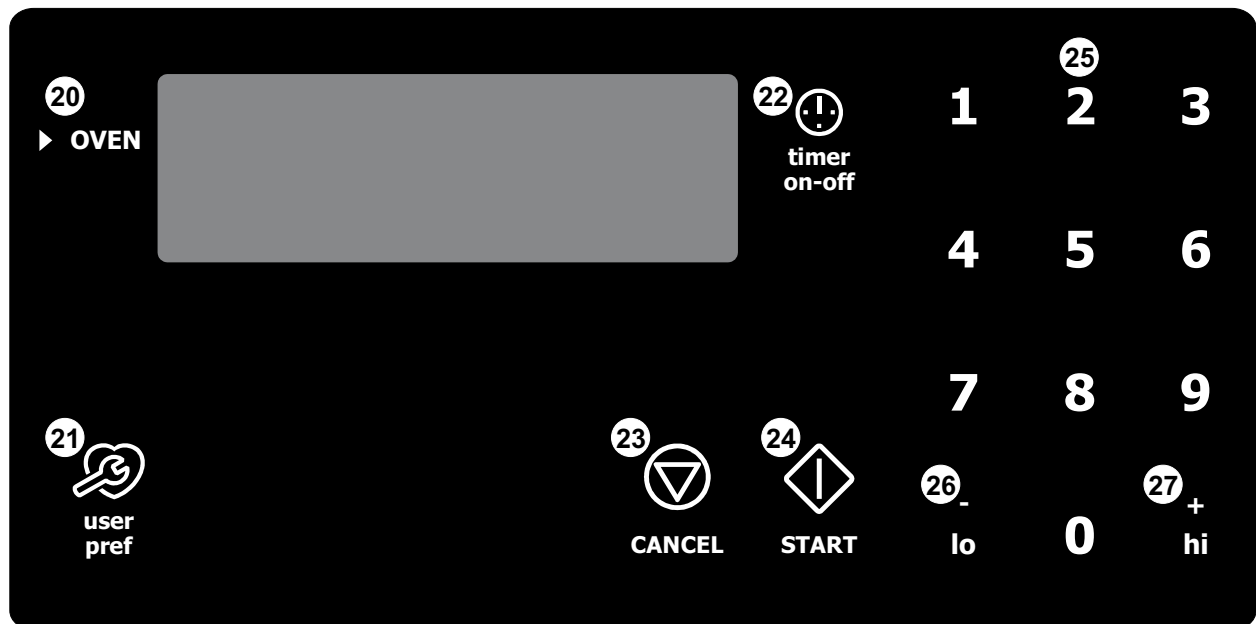

- 20. **Oven Pad**- Used to activate an oven cooking mode.
- 21. **User Preference Pad**- Used to bring the user preference menu in the display.
- 22. **Timer on-off Pad**- Used to set or cancel the minute timer. The minute timer does not start or stop cooking.
- 23. **Cancel Pad**- Used to cancel any functions previously entered except the time of day and

the minute timer. Push **Cancel Pad** to stop cooking.

- 24. **Start Pad**- Used to start all oven functions.
- 25. **0 thru 9 Number Pads** - Used to enter temperature and times.
- 26. **- lo Pad**- Used to lower the temperature and times.
- 27. **+ hi Pad**- Used to raise the temperature and times.

Getting Started

Setting clock at power up

When the unit is first plugged in, or when the power supply to the range has been interrupted, the timer in the display will flash with "CLO 12:00". The clock cannot be set when the oven is on. If an invalid time of day is entered, the control will triple beep to prompt you to re-enter a valid time of day.

To set the clock (example for 1:30)

1. Press **1 3 0** pads to set the time of day to 1:30. The pads **HI** or **LO** can also be pressed to raise or lower the actual time displayed.
2. Press **START** to accept the changes or **CANCEL** to start with a time of 12:00.

Temperature visual display

Your oven is equipped with a temperature visual display. When a cooking mode is set, the actual temperature will be shown in the display and will rise as the unit preheats. When the unit has reached its target temperature, a chime will sound to remind you to place the food in the oven. This feature will be active with some cooking modes; bake, convection bake and convection roast. The cooking modes which does not feature the temperature visual display will be noted in their descriptions.

NOTE: The lowest temperature that can be displayed is 100°F.

Oven light

Your appliance includes "theater" style oven lighting feature that gradually lights the oven interiors to full brightness. The oven is equipped with 2 halogen lights. The oven lights will turn on automatically, when the oven door is opened. The oven light may be turned on when the door is closed by using the oven light pad located on the control panel. The oven light key will toggle the lights at full intensity.

To toggle the Oven Lights ON and OFF

1. Press **OVEN LIGHT**.

Control lock

The Control Lock feature automatically locks the upper oven door, control panel. The Control Lock is only allowed when the oven is turned OFF (not active). **DOOR LOCK** will flash in the display for 20 seconds or until the door has finished locking. Once the door has been locked, **Loc** message will appear in the upper display. Do not attempt to open the oven door while **DOOR LOCK** is flashing.

To toggle the Control Lock ON and OFF

1. Keep **CONTROL LOCK** pressed for 3 seconds.

Setting the kitchen timer

This unit is equipped with a kitchen timer which serve as an extra timer in the kitchen that will beep when the set time has run out. It does not start or stop cooking. The Timer feature can be used during any of the other oven control functions and cooking modes.

To set the Timer (example for 5 minutes)

1. Press **TIMER**. "**00:00**" will appear in the display.
2. Press **5** pad to set the timer to 5 minutes. The pads **HI** or **LO** can also be pressed to raise or lower the actual time displayed.
3. Press again **TIMER** to accept and start the countdown.
4. When the set time has run out, "**00:00**" will be displayed and the **TIMER** pad will flash. The clock will sound a chime that will be repeated at regular intervals until the **TIMER** pad is pressed.

To cancel the Timer before the set time has run out:

Press **TIMER**. The display will return to the time of day.

Setting Oven Controls

Rapid preheat

The Preheat feature will bring the oven up to temperature faster than a regular preheat and then indicate when to place the food in the oven. Preheating is not necessary when roasting or cooking casseroles. The oven can be programmed to preheat at any temperature between 170°F to 550°F with some of the cooking modes; Bake, Convection Bake and Convection Roast.

IMPORTANT: The rapid preheat feature is for single rack **ONLY**. The heat distribution with multiple rack will be uneven.

To set a rapid preheat (example is for a 350°F Bake)

1. Press **OVEN**.
2. Press **BAKE**.
3. Press **RAPID PREHEAT**.
4. Press **START** to begin the baking with the rapid preheat feature enabled.
5. Place food in the oven when the chime signals and **PRE-HEATING** message disappears indicating that the oven has reached the set target temperature.

10 Setting Oven Controls

Baking

This mode is best used for your standard recipes. The hidden bake element is used to heat the air and maintain temperature. The oven can be programmed to bake at any temperature from 170°F to 550°F with a default temperature of 350°F.

Baking Tips

- Always preheat your oven before using the bake mode.
- During preheat, the 3 elements and the convection fan are used in cycle to quickly heat the oven.
- Use only one rack and center the pans as much as possible.
- If using two racks, place the oven racks in positions 3 and 7.
- Allow 2" to 4" (5,1 to 10,2cm) around the utensil(s) for proper air circulation.
- Be sure the pans do not touch each other, the door, sides or back of the oven.

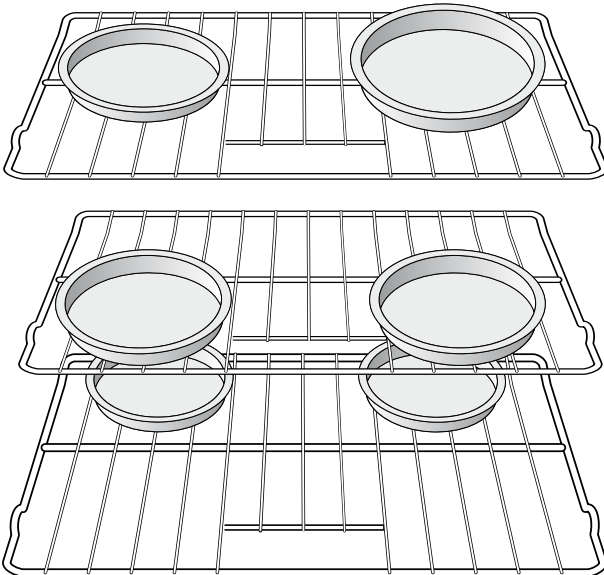

Stagger pans as shown.

To set a Bake Temperature of 350°F

1. Arrange interior oven racks.
2. Press **OVEN** ► **OVEN**.
3. Press **BAKE**.
4. Press **START**. The oven display shows **PRE-HEATING**.
5. Place food in the oven when the chime signals and temperature display shows that the oven has reached the set target temperature and the **PRE-HEATING** message disappear.
6. The Cook Time, Timer, End Time and Rapid Preheat features can be set to control your cooking time (read their sections for directions).
7. Remove food. Always use oven mitts when removing hot pans from the oven.
8. Press **CANCEL** to stop or cancel the Bake feature at any time.

To change to a Bake Temperature of 425°F

1. Press the **HI** or **LO** pads to get to the desired temperature. Each press of **+** or **-** will adjust the temperature by 5°F (or 2°C)

Baking Problems

Refer to the Baking Problems Table in the Solutions to Common Problems section of this manual.

Cook time

Cook Time allows the oven to be set to cook for a set length of time and shut off automatically.

The time remaining will always be shown in the timer section of the display. The oven will shut off and will beep when the countdown is finished. This feature can be used with Bake, Convection Bake, Convection Roast, Slow Cook, Keep Warm, Bread Proof and Dehydrate cooking modes.

To set a timed cooking (*example is a 450°F Bake for 30 minutes*)

1. Press **OVEN**.
2. Press **BAKE**. The temperature numbers will blink in the display.
3. Enter temperature needed; **4 5 0**.
4. Press **COOK TIME**.
5. Enter time needed; **3 0**.
6. Press **START**. The oven will start heating. The cook time will start counting down for the set time.
7. Press **CANCEL** to stop the audible alarm or to cancel the cook time at anytime.

End time

End Time allows the oven to be set to shut off automatically at a set time of day. The oven control will calculate the remaining time by itself. The time remaining will always be shown in the timer section of the display. The oven will shut off and will beep when the countdown is finished. This feature can be used with Bake, Convection Bake, Convection Roast, Slow Cook, Keep Warm, Dehydrate, Clean and Bread Proof cooking modes. This oven can be programmed with Cook Time and End Time to start and stop by itself at the right time.

To set a delayed timed cooking (*example is a 450°F Bake for 30 minutes which will end at 6:00PM*)

1. Press **OVEN**.
2. Press **BAKE**. The temperature numbers will blink in the display.
3. Enter temperature needed; **4 5 0**.
4. Press **COOK TIME**.
5. Enter time needed; **3 0**.
6. Press **END TIME**.
7. Enter time of day needed; **6 0 0**.
8. Press **START**. The time remaining will be shown in the display.
9. Press **CANCEL** to stop the audible alarm or to cancel the cook time at anytime.

CAUTION

Use caution with the **COOK TIME** or **END TIME** features. Use the automatic timer when cooking cured or frozen meats and most fruits and vegetables. Foods that can easily spoil such as milk, eggs, fish, meat or poultry, should be chilled in the refrigerator first. Even when chilled, they should not stand in the oven for more than 1 hour before cooking begins, and should be removed promptly when cooking is completed. Eating spoiled food can result in sickness from food poisoning.

12 Setting Oven Controls

Broiling

This mode is best for meats, fish and poultry up to 1" thick. Broiling is a method of cooking tender cuts of meat by direct heat under the broil element of the oven. The high heat cooks quickly and gives a rich, brown outer appearance. The oven can be programmed to broil at any temperature from 300°F to 550°F with a default temperature of 550°F.

Broiling Tips

- For optimum browning, preheat the broil element for 2 minutes.
- Broil one side until the food is browned; turn and cook on the second side. Season and serve.
- Always pull the rack out to the "stop" position before turning or removing food.
- Always use the broiler pan and its grid when broiling. It allows the dripping grease to be kept away from the high heat of the broil element (see Figure 1).
- For best broiling results, broil with the oven door slightly open.
- **DO NOT** use the broil pan without the insert. **DO NOT cover the broil pan insert with foil.** The exposed grease could catch fire. **DO NOT** use the roasting rack when broiling.

To set a Broil Temperature of 550°F

1. Arrange interior oven racks.
2. Press **OVEN**.
3. Press **BROIL**.
4. Press **START**.
5. Place food in the oven after 2 minutes.
6. Turn food when the top side is browned and cook on the second side.
7. Remove food. Always use oven mitts when removing hot pans from the oven.
8. Press **CANCEL** to stop or cancel the Broil feature at any time.

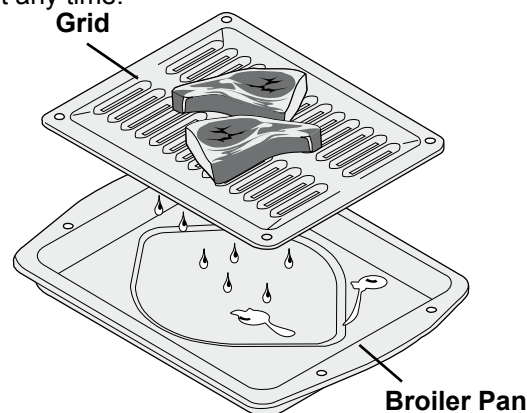

Figure 1

Broiling Times

Electric Wall Oven Broiling Table Recommendations					
Food Item	Rack Position	Temp. Setting	Cook Time		Doneness
			1st side	2nd side	
Steak 1" thick	7	550°F	6:00	4:00	Rare
	7	550°F	7:00	5:00	Medium
Pork Chops 3/4" thick	7	550°F	8:00	6:00	Well
Chicken - Bone In	5	450°F	20:00	10:00	Well
Chicken - Boneless	7	450°F	8:00	6:00	Well
Fish	7	500°F	13:00	n/a	Well
Shrimp	5	550°F	5:00	n/a	Well
Hamburger 1" thick	7	550°F	9:00	7:00	Medium
	5	550°F	10:00	8:00	Well

WARNING

Should an oven fire occur, close the oven door and turn off the oven. If the fire continues, throw baking soda on the fire or use a fire extinguisher. **DO NOT** put water or flour on the fire. Flour may be explosive and water can cause a grease fire to spread and cause personal injury.

Convection baking

This mode of cooking enables you to obtain the best culinary results when baking with multiple pans and racks. Multiple rack baking may slightly increase cook time for some foods but the overall result is time saved. Most foods cooked in a standard oven will cook faster and more evenly with Convection Bake. Convection baking uses the three elements and a fan to circulate the oven's heat evenly and continuously within the oven. The oven can be programmed for Convection baking at any temperature between 170°F to 550°F with a default temperature of 350°F.

Convection Baking Tips:

- Always preheat your oven before using the Convection Bake mode.
- During preheat, the 3 elements and the convection fan are used in cycle to quickly heat the oven.
- If your recipe cooking temperature has already been converted for convection baking there is no need to reduce your oven temperature. If your recipe has not had the temperature converted for convection baking you can easily reduce using the Convection Convert feature. Please see Convection Convert section on next page for further instruction on temperature conversion.
- Use tested recipes with times adjusted for convection baking when using this mode. With single rack convection baking the some foods may have as much as a 25% reduction in cook time, check food at minimum time. Time reductions will vary depending on the amount and type of food to be cooked.
- When using Convection Bake with a single rack, place oven rack in position 3 or 4. If cooking on multiple racks, place the oven racks in positions 2 and 6 or 1, 4 and 7.
- Most bakeries (except cakes) should be baked on pans with no sides or very low sides to allow heated air to circulate around the food.
- Food baked on pans with a dark finish will cook faster.

To set a Convection Bake Temperature of 350°F

1. Arrange interior oven racks.
2. Press **OVEN**.
3. Press **CONVECTION BAKE**.
4. Press **START**. The oven display shows **PRE-HEATING**.
5. Place food in the oven when the chime signals and temperature display shows that the oven has reached the set target temperature and the **PRE-HEATING** message disappear.
6. The Cook Time, Timer, End Time and Rapid Preheat features can be set to control your cooking time (read their sections for directions).

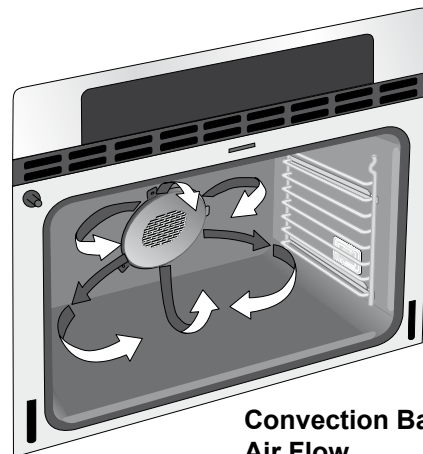

**Convection Bake
Air Flow**

14 Setting Oven Controls

Convection roasting

This mode is best for cooking tender cuts of beef, lamb, park and poultry. Use this mode when cooking speed is desired. The Convection Roasting gently browns the exterior and seals in the juices. Convection roasting uses the hidden bake element, the hidden convection element, the broil element and a fan to circulate the oven's heat evenly and continuously within the oven. The oven can be programmed for Convection Roasting at any temperature between 170°F to 550°F with a default temperature of 350°F.

Convection Roasting Tips

- Use the broiler pan and grid, and the roasting rack (Figure 1). The broiler pan will catch grease spills and the grid will help prevent spatters. The roasting rack will hold the meat.
- Place an oven rack on rack position 2 (next-bottom).
- Make sure the roasting rack is securely seated on the grid in the broiler pan. The roasting rack fits on the grid allowing the heated air to circulate under the food for even cooking and helps to increase browning on the underside.
- There is no need to reduce the convection temperature or to use the Convection Convert feature with this cooking mode.
- **DO NOT** use the broiler pan without the grid or cover the grid with aluminum foil.
- Always pull the rack out to the stop position before removing food.
- Position food (fat side up) on the roasting rack.

To set a Convection Roast Temperature of 350°F

1. Arrange interior oven racks.
2. Press **OVEN**.
3. Press **CONVECTION ROAST**.
4. Press **START**.
5. The Cook Time, Timer, End Time and Rapid Preheat features can be set to control your cooking time (read their sections for directions).
6. Remove food. Always use oven mitts when removing hot pans from the oven.
7. Press **CANCEL** to stop or cancel the Convection Roast feature at any time.

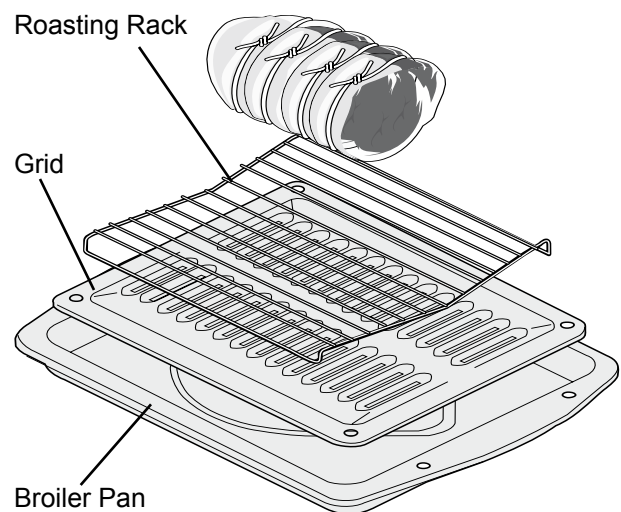

Figure 1

Convection Roasting Chart					
Meat		Weight	Oven Temp	Internal Temp	Cooking Time
Beef	Standing rib roast	4 to 6lbs.	350°F	*	25-30
	Rib eye roast	4 to 6lbs.	350°F	*	25-30
	Tenderloin roast	2 to 3lbs.	400°F	*	15-25
Poultry	Turkey, whole**	12 to 16lbs.	325°F	180°F	8-10
	Turkey, whole**	16 to 20lbs.	325°F	180°F	10-15
	Turkey, whole**	20 to 24lbs.	325°F	180°F	12-16
	Chicken	3 to 4lbs.	350-375°F	180°F	12-16
Pork	Ham roast, fresh	4 to 6 lbs.	325°F	160°F	30-40
	Shoulder blade roast	4 to 6 lbs.	325°F	160°F	20-30
	Loin	3 to 4lbs.	325°F	160°F	20-25
	Pre-cooked ham	5 to 7lbs.	325°F	160°F	30-40

* For beef: med rare 145°F, med 160°F, well done 170°F

** Stuffed turkey requires additional roasting time. Shield legs and breast with foil to prevent over browning and drying of the skin.

Convection broiling

Use this mode for thicker cuts of meat, fish and poultry. The Convection Broiling gently browns the exterior and seals in the juices. Convection broiling uses the broil element and a fan to circulate the oven's heat evenly and continuously within the oven. The oven can be programmed for Convection Broiling at any temperature between 300°F to 550°F with a default temperature of 550°F.

Convection Broiling Tips

- For optimum browning, preheat the broil element for 2 minutes.
- Broil one side until the food is browned; turn and cook on the second side. Season and serve.
- Always pull the rack out to the "stop" position before turning or removing food.
- Always use the broiler pan and its grid when broiling. It allows the dripping grease to be kept away from the high heat of the broil element (see Figure 1).
- **DO NOT** use the broil pan without the insert. **DO NOT cover the broil pan insert with foil.** The exposed grease could catch fire. **DO NOT** use the roasting rack when broiling.
- Convection broiling is generally faster than conventional broiling. Check for doneness at the minimum recommended time.

IMPORTANT: Always use this cooking mode with the oven door closed or the fan will not turn on.

To set a Convection Broil Temperature of 550°F

1. Arrange interior oven racks.
2. Press **OVEN**.
3. Press **CONVECTION BROIL**.
4. Press **START**.
5. Place food in the oven after 2 minutes.
6. Turn food when the top side is browned and cook on the second side.
7. Remove food. Always use oven mitts when removing hot pans from the oven.
8. Press **CANCEL** to stop or cancel the Convection Broil feature at any time.

WARNING

Should an oven fire occur, leave the oven door closed and turn off the oven. If the fire continues, throw baking soda on the fire or use a fire extinguisher. **DO NOT** put water or flour on the fire. Flour may be explosive and water can cause a grease fire to spread and cause personal injury.

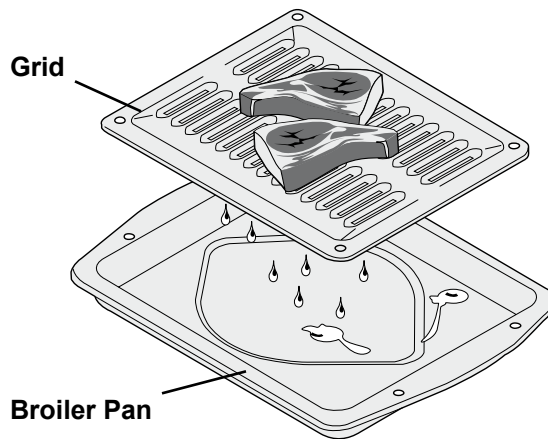

Convection convert

The Convection Convert pad is used to automatically convert a standard baking recipe for convection baking. When set properly, this feature is designed to display the actual converted (reduced) temperature in the display. Convection Convert may **ONLY** be used with a Convection Bake cooking mode. It can be used with the features End Time and Cook Time (see their sections for directions). If convection conversion is used with the cook time and end time features, "CF" (check food) will be displayed when 75% of the bake time complete. At this time the oven control will sound 3 long beeps at regular intervals until baking had finished. When the bake time has completely finished the control will beep at regular interval until the **CANCEL** pad is pressed.

NOTE: To use this feature with the **COOK TIME** option, the **COOK TIME** pad must be pressed before the **CONVECTION CONVERT** pad.

Changing from a normal bake temperature to a convection bake temperature

1. Press **OVEN**.
2. Press **CONVECTION BAKE**.
3. Press **CONVECTION CONVERT**. The temperature displayed will be 25°F lower than what it used to be.
4. Press **START** to begin the convection baking (see Convection Baking section for more informations).

16 Setting Oven Controls

Keep warm

This mode is best for keeping oven baked foods warm for serving after cooking has finished. The Keep Warm feature uses the hidden bake element to maintain the temperature within the oven. The oven can be programmed for Keep Warm at any temperature between 150°F to 190°F with a default temperature of 170°F.

Keep Warm Tips

- Always start with hot food.
- Do not use the Keep Warm feature to heat cold food.
- Food in heat-safe glass and glass ceramic containers may need higher temperature settings compared to food in regular containers.
- Avoid repeated openings of the oven, it will allow hot air to escape and the food to cool.
- Aluminum foil may be used to cover food to increase moisture content.

To set a Warm Keep Temperature of 170°F

1. Arrange interior oven racks.
2. Press **OVEN**.
3. Press **KEEP WARM**.
4. Press **START**.
5. The Cook Time, Timer and End Time features can be set to control your warming time (read their sections for directions).
6. Remove food. Always use oven mitts when removing hot pans from the oven.
7. Press **CANCEL** to stop or cancel the Keep Warm feature at any time.

Slow cook

This mode may be used to cook foods more slowly, at lower oven temperatures and provide cooking results much the same way as a Slow Cooker or Crock-Pot. The Slow Cook feature is ideal for roasting beef, pork & poultry. Slow Cooking meats may result in the exterior of meats becoming dark but not burnt. This is normal. The Slow Cook mode uses the hidden bake element to maintain a low temperature in the oven. There are 2 settings available, high (HI) or low (LO). The maximum cook time for the Slow Cook feature is 12 hours unless the oven control has been changed to the Continuous Bake mode.

Slow Cook Tips

- Completely thaw all frozen foods before cooking with the Slow Cook feature.
- When using a single rack, position it in the center of the oven.
- Position multiple racks to accommodate size of cooking utensils when cooking multiple food items.
- Do not open the oven door often or leave the door open when checking foods. If the oven heat escapes often, the Slow Cook time may need to be extended.
- Cover the foods to keep them moist or use a loose or vented type cover to allow foods to turn crisp or brown.
- Cook times will vary; depending on the weight, fat content, bone & the shape of the meat.
- Use the recipe's recommended food temperature and a food thermometer to determine when the food is done.
- Preheating the oven will not be necessary when using the Slow Cook feature.
- Add any cream or cheese sauces during the last hour of cooking.

To set a Slow Cook

1. Arrange interior oven racks and place food in the oven.
2. Press **OVEN**.
3. Press **SLOW COOK**.
4. Press **HI** for high (**HI**) setting or **LO** low (**Lo**) setting.
5. Press **START**.
6. The Cook Time, Timer and End Time features can be set to control your Slow Cook time (read their sections for directions).
7. Remove food. Always use oven mitts when removing hot pans from the oven.
8. Press **CANCEL** to stop or cancel the Slow Cook feature at any time.

Dehydrating

This mode dries foods with heat from the bake and the convection element. The heat is circulated throughout the oven by the convection fan. Dehydrating is used to dry and/or preserve foods such as fruits, meats, vegetables and herbs. This mode holds an optimum low temperature while circulating the heated air to slowly remove moisture. The oven can be programmed for Dehydrating at any temperature between 100°F to 225°F with a default temperature of 120°F.

Dehydrating Tips

- Do not preheat the oven.
- Multiple racks can be used simultaneously.
- Drying times vary depending on the moisture and sugar content of the food, the size of the pieces, the amount being dried and the humidity in the air.
- Check food at the minimum drying time.
- Treat fruits with antioxidants to avoid discoloration.
- Consult a food preservation book or a library for additional information.

To set a Dehydrate Temperature of 120°F

1. Arrange interior oven racks and place food.
2. Press **OVEN**.
3. Press **DEHYDRATE**.
4. Press **START** to begin dehydrating.
5. Remove food. Always use oven mitts when removing hot pans from the oven.
6. Press **CANCEL** to stop or cancel the Dehydrate feature at any time.

Bread proofing

Proofing bread prepares the dough for baking by activating the yeast. This feature is ideal for proofing, or rising bread dough. The oven can be programmed for Bread Proofing at any temperature between 85°F to 100°F with a default temperature of 100°F.

Bread Proofing Tips

- No need to preheat for this feature.
- Proof bread until dough has doubled in bulk.
- For best results, place a shallow pan with 1 to 3 cups of boiling hot water on the lowest rack position to keep the air moist inside the oven cavity.
- Allow at least 1" between edge of pan and walls of the oven.
- Limit frequent door openings to prevent losing heat and lengthening proofing time.

To set a Bread Proof

1. Arrange interior oven racks and place bread dough in the oven.
2. Press **OVEN**.
3. Press **BREAD PROOF**.
4. Press **START** to begin the bread proofing.
5. The Cook Time, Timer and End Time features can be set to control your Bread Proof time (read their sections for directions).
6. Remove food.
7. Press **CANCEL** to stop or cancel the Bread Proof feature at any time.

To change a Bread Proof temperature while the function is active:

1. Press the **HI** or **LO** pads to get to the desired temperature.

18 Setting Oven Controls

My favorite

The Favorites settings allows you to save your most frequently used or most complex cooking sequences. This feature will save the cooking mode, the target temperature and the cooktime (if any).

To save a Favorite (example is a 450°F Bake for 30 minutes)

- Saving a Favorite can only be done for an oven which is currently in operation.

1. Press **OVEN**.
2. Press **BAKE**. The default temperature will appear in the display.
3. Enter temperature needed; **4 5 0**.
4. Press **COOK TIME**. The time numbers will blink in the display.
5. Enter time needed; **3 0**.
6. Press **START**.
7. Press and hold for 3 seconds any **MY FAVORITE** pad. Notice that the red indicator above the key will light up.

To recall a Favorite

- Recalling a Favorite can only be done for an oven which is not currently in operation.

1. Press **OVEN**.
2. Press **MY FAVORITE** pad which is currently lighted up.
3. Press **START**.

To overwrite a Favorite:

1. To overwrite a My Favorite simply start a new cooking sequence and save it into My Favorite. The new My Favorite settings will overwrite the old one.

To delete a Favorite:

1. Select oven by pressing.
2. Press **MY FAVORITE** pad for **3 seconds**.

Sabbath feature (for use on the Jewish sabbath & holidays)

The **HI** and **LO** pads are used to set the Sabbath feature. The Sabbath feature may only be used with the **BAKE** pad. The oven temperature may be set higher or lower after setting the Sabbath feature (the oven temperature adjustment feature should be used only during Jewish Holidays), however the display will not visibly show or provide any audible tones indicating whether the change occurred correctly. Once the oven is properly set using Bake with the Sabbath feature active, the oven will remain continuously ON until cancelled. This will override the factory preset 12-Hour Energy Saving feature.

If the oven light will be needed during the Sabbath, press **OVEN LIGHT** before activating the Sabbath feature. Once the oven light is turned ON and the Sabbath feature is active, the oven light will remain ON until the Sabbath feature is turned OFF. If the oven light needs to be OFF, be sure to turn the oven light OFF before activating the Sabbath feature.

IMPORTANT NOTES: It is not advised to attempt to activate any other program feature other than **BAKE** while the Sabbath feature is active. ONLY the following key pads will function after setting the Sabbath feature; **0 to 9, BAKE, START, CANCEL, HI and LO. ALL OTHER KEYPADS** will not function once the Sabbath feature is properly activated.

To Program the Upper Oven to Begin Baking Immediately & Activate the Sabbath feature (example: baking at 350°F)

1. Place the food in the oven.
2. Press **OVEN**.
3. Press **BAKE**.
4. If you desire to set the oven control for a **COOK TIME** do so at this time. If not, skip this step and continue to step 5. Refer to their section for complete instructions. Remember the oven will shut down after using **COOK TIME** and therefore may only be used once during the Sabbath/Jewish Holidays.

Sabbath feature (for use on the Jewish sabbath & holidays)

5. Press **START**.
6. The oven will turn ON and begin heating immediately.
7. Press and hold both the **HI** and **LO** pads for at least 3 seconds. **SAb** will appear in the oven display. Once **SAb** appears in the display the oven control will no longer beep or display any further changes and the oven is properly set for the Sabbath feature.

Note: You may change the oven temperature once baking has started. The **HI** pad will increase the temperature by 5°F (or 2°C if set to Celsius mode) and the **LO** pad will decrease the temperature by 5°F (or 2°C if set to Celsius mode). Remember that **the oven control will no longer beep or display any further changes** once the oven is set for the Sabbath feature.

8. The oven may be turned OFF at any time by pressing **CANCEL** pad (this will turn the oven OFF only). To turn OFF the Sabbath feature press and hold both the **HI** and **LO** pads for at least 3 seconds. **SAb** will disappear from the display.

Should you experience a power failure or interruption, the oven will shut off. When power is returned the oven will not turn back on automatically. **SF** (Sabbath Failure) will be displayed in the oven control display. The oven will remember that it is set for the Sabbath and the food may be safely removed from the oven while still in the Sabbath feature, however the oven cannot be turned back on until after the Sabbath. After the Sabbath observance turn OFF the Sabbath feature. Press and hold both the **HI** and **LO** pads for at least 3 seconds. **SAb** will disappear from the display and the oven may be used with all normal functions. For further assistance, guidelines for proper usage, and a complete list of models with the Sabbath feature, please visit the web at <http://www.star-k.org>.

Setting Your Preferences

User Preferences

The User Preferences menu includes all user defined options. This feature enables you to control the various options of the electronic controls. This menu features the Time of Day, Celsius or Fahrenheit display mode, Continuous Bake or 12 Hour Energy Saving modes, Clock display or No-Clock display, 12 Hours Time of Day or 24 Hours Time of Day, Audio Control, and Adjusting the oven temperature. The User Preferences menu is only available when the oven is not being used (not cooking).

To browse through the User Preferences menu

1. Press **USER PREF** to bring up the User Preferences menu.
2. Press **USER PREF** again to browse through the menu pages.
3. Press **LO** or **HI** to toggle between the available options.
4. Press **START** while the chosen option is on display to change.
5. Press **CANCEL** when finished to get back to the standard oven display.

User Preferences menu items:

- **CLO 12:00**; Setting the clock.
- **CLO on**; Clock on/off.
- **CLO 12hr**; 12/24 hour time of day display.
- **F-C F**; Fahrenheit / Celsius display.
- **E S on**; 12 hour Energy Saving on/off.
- **AUd**; Audio on/off and volume.
- **UPO**; Adjusting oven temperature.
- **rSt**; Reset to default factory settings.

Setting the clock- Time of day

The clock may be set for 12 or 24 hour time of day operation (see advanced settings section). The clock has been preset at the factory for the 12 hour operation. When the range is first plugged in, or when the power supply to the range has been interrupted, the display will show "CLO 12:00". The clock must be set before the oven can be used. When power to the unit has been interrupted, "12:00" appears and flashes in the display. To set the Clock in this case, skip step 1 in the example below and follow steps 2 and 3.

To set the clock (example for 1:30)

1. Press **USER PREF** until you get to the **CLO 12:00** menu page.
2. Press **1 3 0** pads to set the time of day to 1:30. The pads **HI** or **LO** can also be pressed to raise or lower the actual time displayed.
3. Press **START** to accept the changes and go back to user preferences menu display.
4. Press **CANCEL** when finished to get back to the standard oven display.

Setting the clock- On or Off

The oven control can be programmed to display the time of day or not. The oven has been preset at the factory to display the time of day.

Changing clock display between ON and OFF

1. Press **USER PREF** until you get to the **CLO on** menu page.
2. Press **LO** or **HI** to toggle between displaying or hiding the clock.
3. Press **START** to accept the changes and go back to user preferences menu display.
4. Press **CANCEL** when finished to get back to the standard oven display.

Setting time of day display- 12 or 24 hours

The oven control can be programmed to display time of day in 12 hours or 24 hours mode. The oven has been preset at the factory to display in 12 hours mode.

Changing between 12 or 24 hour time of day display

1. Press **USER PREF** until you get to the **CLO 12hr** menu page.
2. Press **LO** or **HI** to toggle the display of the clock in 12 or 24 hours.
3. Press **START** to accept the changes and go back to user preferences menu display.
4. Press **CANCEL** when finished to get back to the standard oven display.
5. Remember to set your clock after changing the time of day display mode.

Setting temperature display- Fahrenheit or Celsius

The oven control can be programmed to display temperatures in Fahrenheit or Celsius. The oven has been preset at the factory to display in Fahrenheit.

To change display from Fahrenheit to Celsius or Celsius to Fahrenheit

1. Press **USER PREF** until you get to the **F-C F** menu page.
 2. Press **LO** or **HI** to toggle between the **°C** and **°F** display options.
 3. Press **START** to accept the changes and go back to user preferences menu display.
 4. Press **CANCEL** when finished to get back to the standard oven display.
-

Setting continuous bake or 12 hour energy saving

The oven control has a factory preset built-in 12 Hour Energy Saving feature that will shut off the oven if the oven control is left on for more than 11 hours and 59 minutes. The oven can be programmed to override this feature for Continuous Baking.

Changing between 12 hour energy saving and continuous bake

1. Press **USER PREF** until you get to the **E S** menu page.
2. Press **LO** or **HI** to toggle the energy saving setting on and off.
3. Press **START** to accept the changes and go back to user preferences menu display.
4. Press **CANCEL** when finished to get back to the standard oven display.

Audio control

The Audio Control feature allows the oven control to be operated without sounds or beeps whenever necessary. If desired the control can be programmed for silent operation and later returned to operating with all the default sounds and beeps. The volume of the beeps can also be adjusted.

To change the audio mode or audio volume

1. Press **USER PREF** until you get to the **AUd** menu page.
2. Press **LO** or **HI** to toggle between the available volume settings. **AUd 5** for the highest volume setting to **AUd 1** for the lowest volume. **AUd OFF** to disable the beeps.
3. Press **START** to accept the changes and go back to user preferences menu display.
4. Press **CANCEL** when finished to get back to the standard oven display.

Adjusting oven temperature

The temperature in the oven has been pre-set at the factory. When first using the oven, be sure to follow recipe times and temperatures. If you think the oven is too hot or too cool, the temperature in the oven can be adjusted. Before adjusting, test a recipe by using a temperature setting that is higher or lower than the recommended temperature. The baking results should help you to decide how much of an adjustment is needed.

To adjust the oven temperature

1. Press **USER PREFERENCES** until you get to the **UPO** menu page.
2. Enter the temperature by pressing the **LO** or **HI** pads. The temperature can only be adjusted by $\pm 35^{\circ}\text{F}$.
3. Press **START** to accept the changes and go back to user preferences menu display.
4. Press **CANCEL** when finished to get back to the standard oven display.

Re-setting to default factory settings

The oven control can be set to return to its original factory settings. This includes: Setting the Clock ON/OFF to ON, Setting the clock display mode to 12h, Display mode to Fahrenheit, Setting the oven temperature adjustment to zero, Setting audio level to 5 and Enabling the 12h energy saving mode. Resetting the control also erases the My Favorite recipes.

To reset the oven control to its original settings

1. Press **USER PREF** until you get to the **rSt no** menu page.
2. Press **LO** or **HI** to select **YES**.
3. Press **START** to reset to default factory settings.

Before starting self-clean

Adhere to the Following Cleaning Precautions:

- Allow the oven to cool before cleaning.
- Wear rubber gloves when cleaning any exterior parts of the oven manually.
- Before cleaning any part of the oven, be sure the oven is turned off or else push **CANCEL** pad. Wait until the oven is cool.
- **DO NOT** use commercial oven cleaners or oven protective coatings in or around any part of the self-cleaning oven.
- **DO NOT** clean the oven door gasket. The gasket on the oven door is essential for a good seal. Care should be taken not to rub, damage or move the gasket.
- **DO NOT** use any cleaning materials on the gasket. Doing so could damage it.
- **DO NOT** force the oven door open. The automatic door locking system can be damaged.
- Remove the broiler pan, insert, all utensils and any **aluminum foil**. These items can not withstand high cleaning temperatures.
- All oven racks and supports **MUST** be removed. If they are left in while attempting to set the self-clean cycle, the display will show **REMOVE RACKS**. The oven control will not start a self-clean cycle without first removing all the oven racks and supports.
- **Remove any excess spillovers** in the oven cavity **before** starting the self-cleaning cycle. To clean, use hot, soapy water and a cloth. Large spillovers can cause smoke or a fire when subjected to high temperatures.
- Clean any soil from the oven frame and the door liner (see illustration). These areas heat sufficiently during a self-clean to burn soil on. Clean with hot soapy water.
- **DO NOT** allow food spills with a high sugar or acid content (such as tomatoes, sauerkraut, fruit juices or pie filling) to remain on the surface as they may leave a dull spot even after cleaning.

WARNING

During the self-cleaning cycle, the outside of the oven can become very hot to the touch. **DO NOT** leave small children unattended near the appliance.

CAUTION

- **DO NOT** line the oven walls, oven racks, bottom or any other part of the range with aluminum foil. Doing so will stop heat distribution, produce poor baking results and cause permanent damage to the oven interior (aluminum foil will melt to the interior surface of the oven).
- Use caution when opening the door after the self-clean cycle is finished. The oven may still be **VERY HOT**.
- The health of some birds is extremely sensitive to the fumes given off during the self-clean cycle of any wall oven. Move birds to another well ventilated room.

Do NOT
Hand
Clean Door
Gasket

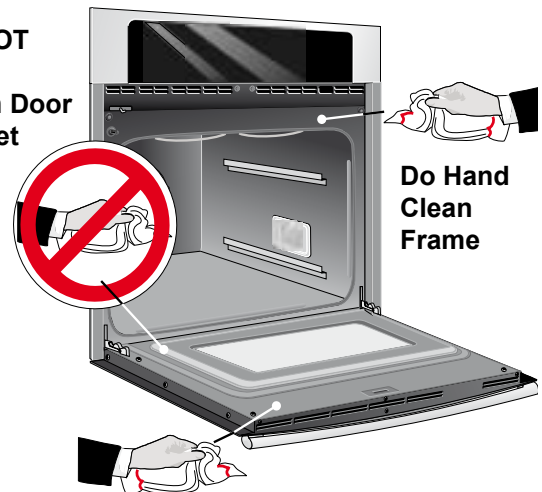



**Do Hand
Clean
Frame**

**Do Hand Clean Door Area
which out of the Door Gasket**



Setting self-clean

A self-cleaning oven cleans itself with high temperatures (well above cooking temperatures) which eliminate soil completely or reduce it to a fine powdered ash you can whisk away with damp cloth. If you are planning to use the oven directly after a self-clean cycle remember to allow time for the oven to cool down and the oven door to unlock. This normally takes about one hour.

1. Remove the oven racks and the racks supports.
2. Be sure the clock is set with the correct time of day and the oven door is closed.
3. Press **OVEN**.
4. Press **LITE CLEAN** for a 2 hours self-clean, **MED CLEAN** for 3 hours, or press **HEAVY CLEAN** for 4 hours cleaning cycle.
5. Press **START**. The "DOOR  icon will flash.
6. As soon as the control is set, the motor driven oven door lock will begin to close automatically. Once the door has been locked the "DOOR  indicator light will stop flashing and remain on.

Note: Allow about 15 seconds for the oven door lock to close.

When the Self-Clean Cycle is Completed

1. The time of day and "DOOR  will remain ON.
2. The display will show an "Hot" message while the oven is still too hot to open door.
3. Once the oven has cooled down for 1 HOUR, and the "DOOR  icon is no longer displayed, the oven door can then be opened.

Stopping or Interrupting a Self-Cleaning Cycle



If it becomes necessary to stop or interrupt a self-cleaning cycle due to excessive smoke:

1. Press **CANCEL**.
2. Once the oven has cooled down for approximately 1 HOUR and the "DOOR  icon is no longer displayed, the oven door can then be opened.

WARNING



During the self-cleaning cycle, the outside of the oven can become very hot to the touch. **DO NOT** leave small children unattended near the appliance.

Setting delayed self-clean

1. Remove the oven racks and the racks supports.
2. Be sure the clock is set with the correct time of day and the oven door is closed.
3. Press **OVEN**.
4. Press **LITE CLEAN** for a 2 hours self-clean, **MED CLEAN** for 3 hours, or press **HEAVY CLEAN** for 4 hours cleaning cycle.
5. Press **START**. The "DOOR  icon will flash.
6. As soon as the control is set, the motor driven oven door lock will begin to close automatically. Once the door has been locked the "DOOR  indicator light will stop flashing and remain on.
7. Press **END TIME**.
8. Enter time of day needed for the end of the cycle (example for "6:00"; **6 0 0**).
9. Press **START**.

Note: Allow about 15 seconds for the oven door lock to close.

When the Self-Clean Cycle is Completed

1. The time of day and "DOOR  will remain ON.
2. The display will show an "Hot" message while the oven is still too hot to open door.
3. Once the oven has cooled down for 1 HOUR, and the "DOOR  icon is no longer displayed, the oven door can then be opened.

Stopping or Interrupting a Self-Cleaning Cycle

If it becomes necessary to stop or interrupt a self-cleaning cycle due to excessive smoke:

1. Press **CANCEL**.
2. Once the oven has cooled down for approximately 1 HOUR and the "DOOR  icon is no longer displayed, the oven door can then be opened.

CAUTION

DO NOT force the oven door open. This can damage the automatic door locking system. Use care when opening the oven door after the self-cleaning cycle. Stand to the side of the oven when opening the door to allow hot air or steam to escape. The oven may still be VERY HOT.

Cleaning Various Parts of Your appliance

Before cleaning any part of the appliance, be sure all controls are turned OFF and the appliance is COOL. REMOVE SPILLOVERS AND HEAVY SOILING AS SOON AS POSSIBLE. REGULAR CLEANINGS WILL REDUCE THE NUMBER OF MAJOR CLEANINGS LATER.

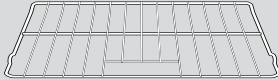
Surfaces	How to Clean
Glass, Painted and Plastic Body Parts and Decorative Trim	<i>For general cleaning</i> , use hot, soapy water and a cloth. <i>For more difficult soils and built-up grease</i> , apply a liquid detergent directly onto the soil. Leave on soil for 30 to 60 minutes. Rinse with a damp cloth and dry. DO NOT use abrasive cleaners on any of these materials; they can scratch.
Control Panel	<i>Before cleaning the control panel</i> , turn all controls to OFF. Lightly spray the control panel with a liquid cleaner. Wipe with a soft cloth or paper towel. DO NOT use abrasive cleaners or scouring pads. These can permanently damage the control panel surface.
Porcelain Enamel Broiler Pan and Grid	Gentle scouring with a soapy scouring pad will remove most spots. Rinse with a 1:1 solution of clear water and ammonia. <i>If necessary</i> , cover difficult spots with an ammonia-soaked paper towel for 30 to 40 minutes. Rinse with clean water and a damp cloth, and then scrub with a soap-filled scouring pad. Rinse and wipe dry with a clean cloth. Remove all cleaners or the porcelain may become damaged during future heating.
Stainless Steel, Chrome Decorative Trim, Oven Racks, Oven Racks Support	Clean with hot, soapy water and a dishcloth. Rinse with clean water and a cloth. Cover stubborn spots with an ammonia-soaked paper towel for 30 to 40 minutes. Rinse. Cleaners made especially for stainless steel are recommended. Be sure to rinse the cleaners as bluish stains may occur during heating and cannot be removed.
Oven Racks	Oven racks and oven rack supports must be removed from the oven during the self-clean cycle for cleaning. If they are not removed, the self-clean cycle will not start. Clean them as described above.
	
Oven Door	To clean oven door, wash with hot, soapy water and a clean cloth. DO NOT immerse the door in water or clean the oven door gasket.
Oven Door Gasket	The oven gasket located on the inner frame of the door and visible when the door is opened is essential for a good seal. Care should be taken not to rub, damage or remove the gasket.

Special door care instructions

→ IMPORTANT

Most oven doors contain glass that can break.
Read the following recommendations:

- **Do not** close the oven door until all the interior oven racks are fully inserted and retracted to the back of the oven.
- Do not hit the glass with pots, pans, or any other object. The oven door glass may break or even break at a later time unexpectedly.
- Scratching, hitting, jarring or stressing the oven door glass may weaken its structure causing an increased risk of breakage at a later time.
- You may use a glass cleaner on the outside of the oven door glass. **Do not spray** or allow water or the cleaner to enter or drip down into the oven door vents. Spray cleaner on cloth first and then wipe the oven door clean.
- **Do not** use strong oven cleaners, powders or any harsh abrasive cleaning materials on the outside of the oven door or glass.
- **Never clean** the oven door gasket. The oven door gasket should always clean during the Self-clean cycle.

Broiler pan cleaning tips

To make cleaning easier, line the bottom of the broiler pan with aluminum foil. **DO NOT** cover the broiler grid with foil.

To prevent grease from baking on, remove the broiler pan from the oven as soon as cooking is completed. Use hot pads because the broiler pan is extremely hot. Pour off grease. Soak the pan in **HOT**, soapy water.

Clean the broiler pan as soon as possible after each use. If necessary, use soap-filled steel wool pads. Heavy scouring may scratch the grid.

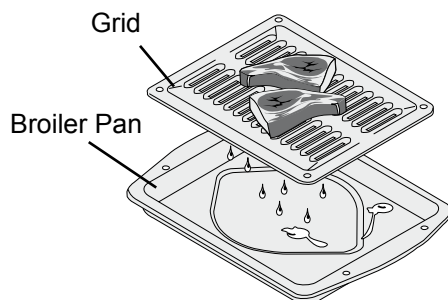

Changing oven lights

⚠ CAUTION

Be sure the range is unplugged and all parts are **COOL** before replacing oven light. Wear a leather-faced glove for protection against possible broken glass or burns.

The oven light bulbs are located on both side of the oven cavity and both are covered with a glass shield. The glass shield must be in place whenever the oven is in use.

Replacing the oven interior light bulbs:

1. Turn electrical power off at the main source or unplug the appliance.
2. Remove oven interior light shield as illustrated below.
3. Replace bulb with a new appliance bulb. Please note: Do not allow your fingers to touch the new bulb when replacing. This will shorten the life of the new bulb. Use a paper towel to cover the new bulb when installing.
4. Replace glass shield over bulb.
5. Turn power back on again at the main source (or plug the appliance back in).
6. The clock will then need to be reset.

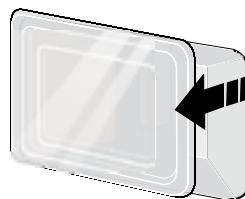

Lift backside of glass shield and remove it.

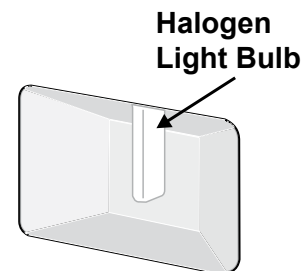

To remove the oven door

CAUTION

- To prevent possible burns, do not attempt to remove the oven door until the oven has completely cooled.
- To avoid possible injury to hands when removing or replacing the oven door, follow the instructions below carefully and always hold the oven door with hands positioned away from the door hinge area (See Fig. 3).

IMPORTANT

The oven door is heavy. Be careful when removing and lifting the door. Do not lift the oven door by the handle.

1. Fully open the oven door.
2. Unlock both oven door hinge locks by pulling them up and away from the oven frame until they stop (unlocked position) -Fig. 2-. If needed use a small flat-bladed screwdriver to assist with loosening the door hinge locks.
3. Firmly grasp both sides of oven door -Fig. 3-.
4. Before completing this step, be prepared to hold the whole weight of the door while grasping the sides of the oven door with both hands. Hold midway down the oven door sides. Close the oven door to about 4 inches and continue closing beyond the door stop position. The oven door should release from the frame on its own -Fig. 3-.
5. Carefully lift door away evenly, slightly up and out until both hinge arms are clear of the hinge slots in the oven frame -Fig. 3-. After door has been removed, be sure to lay the door flat with the inside of the door downward (never rest the oven door with any weight on the door handle).

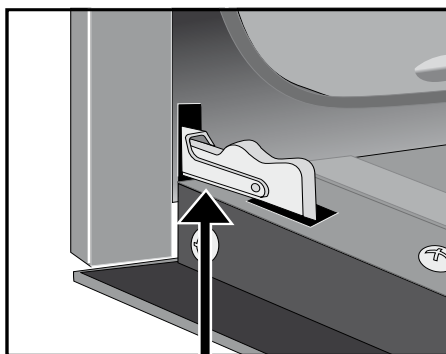

Lock in normal position
Fig. 1

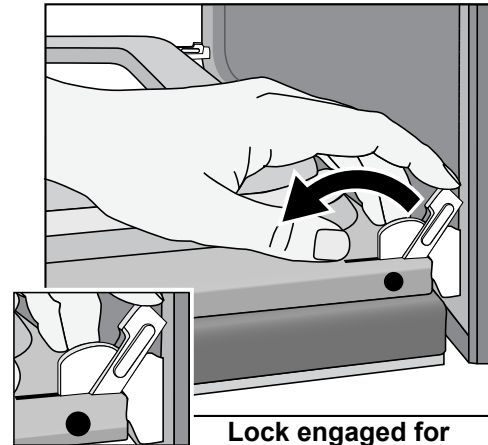

Lock engaged for
door removal

Fig. 2

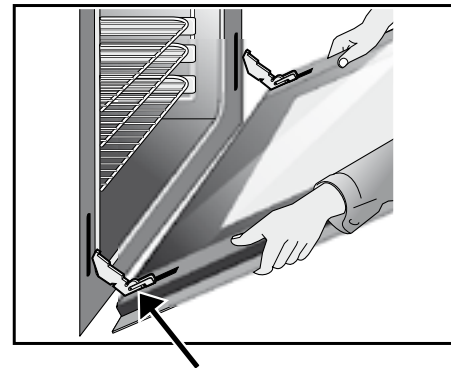

HINGE SLOT - Door removed
from the appliance

Fig. 3





To replace the oven door

1. Firmly grasp the oven door along both sides just below the door handle. When positioning the door hinge arms with the door hinge slots in the oven frame, you may wish to use your knee to stabilize the door before attempting to insert the door hinge arms in the hinge slots.
2. Position the angle of the door to the door removal angle and carefully insert the door hinge arms fully and evenly into the door hinge slots. Carefully let the weight of the door transfer from your hands so that the oven now supports the oven door.
3. Open the oven door down to the fully open position.
4. With the door in the fully open position, push both oven door hinge locks toward the oven frame until they both are locked.
5. Close the oven door.

Baking problems

For best cooking results pre-heat the oven when baking cookies, breads, cakes, pies or pastries, etc. There is no need to preheat the oven for roasting meats or baking casseroles. The cooking times and temperatures needed to bake a product may vary slightly from your previous appliance.

Baking Problems and Solutions Chart

Baking Problems	Causes	Solutions
Cookies and biscuits burn on the bottom. 	<ul style="list-style-type: none"> • Cookies and biscuits put into the oven before the preheating time is completed. • Oven rack overcrowded or rack position too low. • Dark pan absorbs heat too fast. 	<ul style="list-style-type: none"> • Allow oven to preheat to the selected temperature before placing food in oven. • Choose pan sizes that will permit 5.1 cm to 10.2 cm (2" to 4") of air space on all sides when placed in the oven. • Use a medium-weight aluminum baking sheet.
Cakes too dark on top or bottom. 	<ul style="list-style-type: none"> • Cakes put into the oven before preheating time is completed. • Rack position too high or low. • Oven too hot. 	<ul style="list-style-type: none"> • Allow oven to preheat to the selected temperature before placing food in the oven. • Use proper rack position for baking needs. • Set oven temperature 25°F/12°C lower than recommended.
Cakes not done in the center. 	<ul style="list-style-type: none"> • Oven too hot. • Incorrect pan size. • Pan not centered in oven. 	<ul style="list-style-type: none"> • Set oven temperature 25°F/12°C lower than recommended. • Use pan size suggested in recipe. • Use proper rack position and place pan so there is 5.1 cm to 10.2 cm (2" to 4") of space on all sides of pan.
Cakes not level. 	<ul style="list-style-type: none"> • Range not level. • Pan too close to oven wall or rack overcrowded. • Pan warped. 	<ul style="list-style-type: none"> • Place a marked glass measuring cup filled with water on the center of the oven rack. If the water level is uneven, refer to the installation instructions for leveling the range. • Be sure to allow 5.1 cm to 10.2 cm (2" to 4") of clearance on all sides of each pan in the oven. • Do not use pans that are dented or warped.
Foods not done when cooking time is up. 	<ul style="list-style-type: none"> • Oven too cool. • Oven overcrowded. • Oven door opened too frequently. 	<ul style="list-style-type: none"> • Set oven temperature 25°F/12°C higher than suggested and bake for the recommended time. • Be sure to remove all pans from the oven except the ones to be used for baking. • Open oven door only after shortest recommended baking time.

Before you call for service, review the following list. It may save you time & expense. The list includes common occurrences that are not the result of defective workmanship or materials in this appliance.



IMPORTANT

Before calling for service, review this list. It may save you both time and expense. This list includes common experiences that are not the result of defective workmanship or material in your cooktop.

Before you call	
Problem	Solution
Oven control beeps and displays an F error code.	<ul style="list-style-type: none"> Electronic control has detected a fault condition. Push CANCEL pad to clear the display and stop the display from beeping. Reprogram the oven. If a fault reoccurs, record the fault number, push the CANCEL pad and contact an authorized servicer.
Installation	<ul style="list-style-type: none"> Place oven rack in center of oven. Place a level on the oven rack. Contact installing agent if rack and cabinet cutout flooring are not level. Kitchen cabinet misalignment may make range appear to be not level. Be sure cabinets are square and level. Contact cabinet maker to correct problem.
Entire range does not operate	<ul style="list-style-type: none"> When the range is first plugged in, or when the power supply to the oven has been interrupted, the display will flash. The range cannot be programmed until the clock is set. Be sure electrical cord is securely connected into the electrical junction box. Cord/plug is not installed and/or connected. Cord is not supplied with range. Contact your dealer, installing agent or authorized servicer. Service wiring not complete. Contact your dealer, installing agent or authorized servicer. Power outage. Check house lights to be sure. Call your local electric company. Short in cord/plug. Replace cord/plug. Controls are not set properly. See instructions to set the controls. House fuse has blown or circuit breaker has tripped immediately following installation. House fuse may not be fully engaged. Check fuse and screw or engage circuit breaker securely.
Oven light does not work	<ul style="list-style-type: none"> Burned-out or loose bulb. Follow the instructions under Oven Light to replace or tighten the bulb.
Self-cleaning cycle does not work	<ul style="list-style-type: none"> Make sure the oven door is closed. Make sure you have removed the oven racks and the oven rack supports from the oven. Controls not set properly. Follow instructions under "Using the Self-Clean Feature".
Poor cooking results	<ul style="list-style-type: none"> Many factors affect baking results. See baking for hints, cause and corrections. See Adjusting Oven Temperature. Adjust the recipe's recommended power levels or cooking times. Cookware is too lightweight or warped. Use heavier quality cookware so foods being prepared may cook more evenly.
Flames inside oven or smoking from oven vent	<ul style="list-style-type: none"> Excessive spillovers in oven. For example this will happen for pie spillovers or large amounts of grease left on the oven bottom. Wipe up excessive spillovers before starting oven.

Questions or for service call: 1-877-4ELECTROLUX (1-877-435-3287)

Before you call

Problem	Solution
Oven smokes excessively during broiling	<ul style="list-style-type: none">• Meat too close to the broiler element. Reposition the rack to provide more clearance between the meat and the broiler. Preheat broil element for quick searing operation.• Meat not properly prepared. Remove excess fat from meat. Cut remaining fatty edges to prevent curling, but do not cut into the lean.• Grid on broiler pan wrong side-up. Grease does not drain into broiler pan. Always place the grid on the broiler pan with the ribs up and the slots down to allow grease to drip into the pan.• Broiler pan used without grid or grid cover with aluminum foil. DO NOT use the broiler pan without the grid or cover the grid with aluminum foil.• Oven needs to be cleaned. Grease has built up on oven surfaces. Regular cleaning is necessary when broiling frequently. Grease or food spatters cause excessive smoking.
Soil not completely removed after self-cleaning cycle is completed	<ul style="list-style-type: none">• Failure to clean bottom, from top of oven, frame of oven or door area outside oven seal. These areas are not in the self-cleaning area, but get hot enough to burn on residue. Clean these areas before the self-cleaning cycle is started. Burned on residue can be cleaned with a stiff nylon brush and water or a nylon scrubber. Be careful not to damage the oven gasket.• Excessive spillovers in oven. Set the self-clean cycle for longer cleaning time.

Your appliance is covered by a one year limited warranty. For one year from your original date of purchase, Electrolux will repair or replace any parts of this appliance that prove to be defective in materials or workmanship when such appliance is installed, used, and maintained in accordance with the provided instructions. In addition, the glass cooktop or radiant surface element of your appliance (excluding built-in and free-standing range appliances) is covered by a two through five year limited warranty. During the 2nd through 5th years from your original date of purchase, Electrolux will provide a replacement glass cooktop or radiant surface element for your appliance which has proven to be defective in materials or workmanship when such appliance is installed, used, and maintained in accordance with the provided instructions.

Exclusions

This warranty does not cover the following:

1. Products with original serial numbers that have been removed, altered or cannot be readily determined.
2. Product that has been transferred from its original owner to another party or removed outside the USA or Canada.
3. Rust on the interior or exterior of the unit.
4. Products purchased "as-is" are not covered by this warranty.
5. Products used in a commercial setting.
6. Service calls which do not involve malfunction or defects in materials or workmanship, or for appliances not in ordinary household use or used other than in accordance with the provided instructions.
7. Service calls to correct the installation of your appliance or to instruct you how to use your appliance.
8. Expenses for making the appliance accessible for servicing, such as removal of trim, cupboards, shelves, etc., which are not a part of the appliance when it is shipped from the factory.
9. Service calls to repair or replace appliance light bulbs, air filters, water filters, other consumables, or knobs, handles, or other cosmetic parts.
10. Labor or in-home service costs during the additional limited warranty periods beyond the first year from your original date of purchase.
11. Pickup and delivery costs; your appliance is designed to be repaired in the home.
12. Surcharges including, but not limited to, any after hour, weekend, or holiday service calls, tolls, ferry trip charges, or mileage expense for service calls to remote areas, including the state of Alaska.
13. Damages to the finish of appliance or home incurred during transportation or installation, including but not limited to floors, cabinets, walls, etc.
14. Damages caused by: services performed by unauthorized service companies; use of parts other than genuine Electrolux parts or parts obtained from persons other than authorized service companies; or external causes such as abuse, misuse, inadequate power supply, accidents, fires, or acts of God.

DISCLAIMER OF IMPLIED WARRANTIES; LIMITATION OF REMEDIES

CUSTOMER'S SOLE AND EXCLUSIVE REMEDY UNDER THIS LIMITED WARRANTY SHALL BE REPAIR OR REPLACEMENT AS PROVIDED HEREIN. CLAIMS BASED ON IMPLIED WARRANTIES, INCLUDING WARRANTIES OF MERCHANTABILITY OR FITNESS FOR A PARTICULAR PURPOSE, ARE LIMITED TO ONE YEAR OR THE SHORTEST PERIOD ALLOWED BY LAW, BUT NOT LESS THAN ONE YEAR. ELECTROLUX SHALL NOT BE LIABLE FOR CONSEQUENTIAL OR INCIDENTAL DAMAGES SUCH AS PROPERTY DAMAGE AND INCIDENTAL EXPENSES RESULTING FROM ANY BREACH OF THIS WRITTEN LIMITED WARRANTY OR ANY IMPLIED WARRANTY. SOME STATES AND PROVINCES DO NOT ALLOW THE EXCLUSION OR LIMITATION OF INCIDENTAL OR CONSEQUENTIAL DAMAGES, OR LIMITATIONS ON THE DURATION OF IMPLIED WARRANTIES, SO THESE LIMITATIONS OR EXCLUSIONS MAY NOT APPLY TO YOU. THIS WRITTEN WARRANTY GIVES YOU SPECIFIC LEGAL RIGHTS. YOU MAY ALSO HAVE OTHER RIGHTS THAT VARY FROM STATE TO STATE.

If You Need Service

Keep your receipt, delivery slip, or some other appropriate payment record to establish the warranty period should service be required. If service is performed, it is in your best interest to obtain and keep all receipts. Service under this warranty must be obtained by contacting Electrolux at the addresses or phone numbers below.

This warranty only applies in the USA, Puerto Rico and Canada. In the USA and Puerto Rico, your appliance is warranted by Electrolux Major Appliances North America, a division of Electrolux Home Products, Inc. In Canada, your appliance is warranted by Electrolux Canada Corp. Electrolux authorizes no person to change or add to any obligations under this warranty. Obligations for service and parts under this warranty must be performed by Electrolux or an authorized service company. Product features or specifications as described or illustrated are subject to change without notice.

USA

1.800.944.9044

Electrolux Home Products, Inc.,
10200 David Taylor Drive
Charlotte, NC 28262

Canada

1-800-265-8352

Electrolux Canada Corp.
5855 Terry Fox Way
Mississauga, Ontario, Canada L5V 3E4

 **Electrolux**
