

BOSCH

INSTALLATION INSTRUCTION MANUAL

for

Bosch Electric Built-in

Single & Double Oven Models HBL 53../54../55../56..

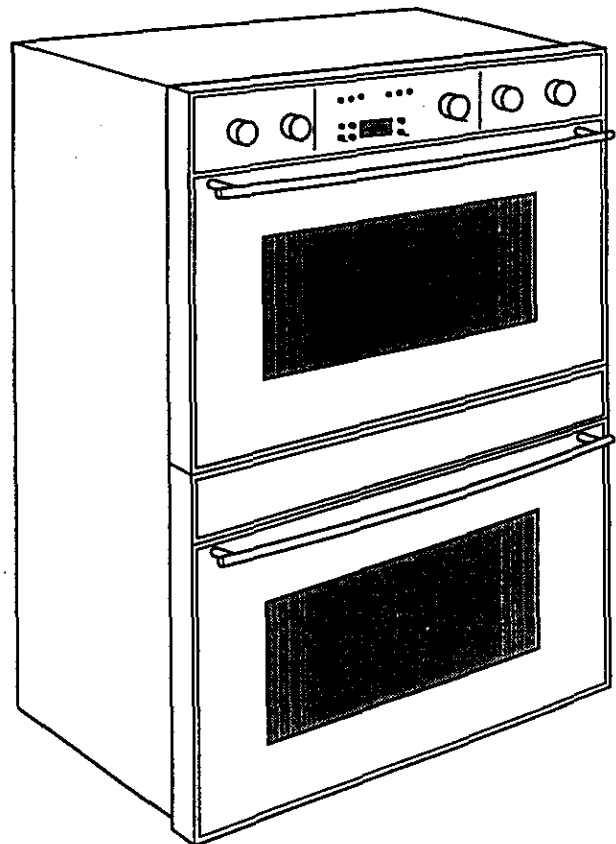
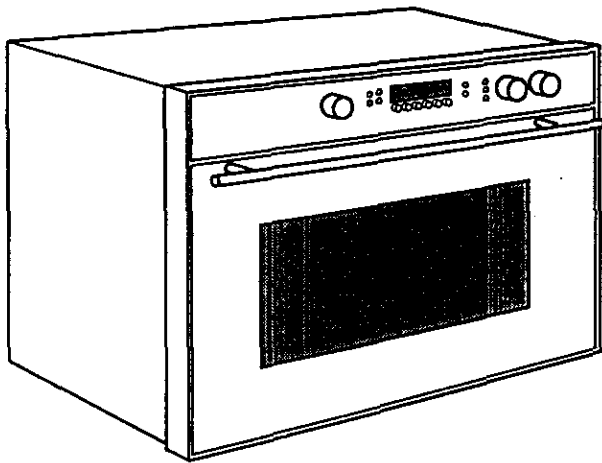

BEFORE YOU BEGIN, READ THESE INSTRUCTIONS COMPLETELY AND CAREFULLY

IMPORTANT: Save these instructions for the local electrical inspector's use
INSTALLER: Please leave this manual with owner for future reference.
OWNER: Please keep this manual for future reference

Table of Contents

INTRODUCTION	3
Tools You Will Need	3
Power Requirements	3
Choosing Oven Location	3
Steps for Installation	3
TECHNICAL DATA	4
Single oven	4
Double oven	4
UNDERCOUNTER INSTALLATION	5
SINGLE OVEN	5
WALL INSTALLATION	6
SINGLE OVEN	6
DOUBLE OVEN	7
ELECTRICAL SUPPLY	8
WIRING REQUIREMENTS	8
CONNECTING TO 208 VOLT CIRCUIT	9
ELECTRICAL CONNECTIONS	10
3-WIRE BRANCH CIRCUIT	10
4-WIRE BRANCH CIRCUIT	10
FINAL CHECKLIST	11

INTRODUCTION

Please read these instructions **COMPLETELY AND CAREFULLY**. They will save you time and effort and help to ensure optimum oven performance. Be sure to observe all **WARNINGS**.

These installation instructions are intended for use by a qualified installer. In addition to these instructions the oven shall be installed:

- In the United States, in accordance with the National Electric Code/State and Municipal codes and/or local codes.
- In Canada, in accordance with Canadian Electric Code C22.1-latest edition/Provincial and Municipal codes and/or local codes.

These shall be carefully followed at all times.

Note: If installing your oven in Canada please check to make sure that you have a model with the UL Canadian listing mark, as shown below:



The UL Canadian listing mark consists of the circled UL symbol preceded by the letter "C", as shown. This should appear on the oven's rating plate along with the UL United States listing mark, which is the circled UL symbol above but not preceded by the letter "C".

TOOLS YOU WILL NEED

The following tools are needed to install your new cook-top:

- Tape measure and straightedge or ruler
- Pencil
- Phillips screwdriver
- Level
- Wire cutters and wire stripper
- 1" hole saw
- Hand or saber saw.

POWER REQUIREMENTS

The oven must be supplied with the proper voltage and frequency. The oven is manufactured to be connected to a three wire or four wire, single phase, 240 volt, 60 Hz AC electrical supply on a separate circuit fused on both sides of the line. If

a 208 volt circuit must be used, wiring inside the oven must be modified. See **Connection to a 208 Volt Circuit**, in this manual. A circuit breaker or time-delay fuse sized not to exceed the circuit rating of the appliance specified on the rating plate located on the frame behind the door of the oven is recommended.

The oven must be supplied with copper wires **ONLY**.

It is recommended that you have the electrical wiring and hook-up of your oven performed by a qualified electrician. After installation is complete have the electrician show you where the main disconnect is and which of the circuit breakers/fuses are for the cook-top.

CHOOSING OVEN LOCATION

Carefully select the location where the oven will be placed. The oven should be located for convenient use in the kitchen, but away from strong drafts. Strong drafts may be caused by open doors or windows, or by heating and/or air conditioning vents or fans. Make sure that electrical power can be provided to the location selected.

STEPS FOR INSTALLATION

The following pages provide the necessary information for proper installation of the oven arranged as follows:

- Technical Data
- Installation Cutout Dimensions, Required Clearances and Mounting instructions for:
 - > Undercounter Installation, Single Oven
 - > Wall Installation, Single Oven
 - > Wall Installation, Double Oven
- Electrical Supply and Wiring Requirements
- Modifications required if Connecting to 208 Volt Circuit.
- Electrical Connections for 3-wire or 4-wire Branch Circuit.
- Final Checklist.

TECHNICAL DATA

SINGLE OVEN

For cutout dimensions see following sections titled:

Preparing Location

Single Oven Models	Electrical Ratings and Maximum Connected Load				Convection Oven
	Volts	Hertz	Amperes @240V/208V	Watts @240V/208V	
HBL 532A UC	240/208	60	13.5/13.6	3,250/2,820	No
HBL 535A UC	240/208	60	13.5/13.6	3,250/2,820	No
HBL 536A UC	240/208	60	13.5/13.6	3,250/2,820	No
HBL 542A UC	240/208	60	13.5/13.6	3,250/2,820	Yes
HBL 545A UC	240/208	60	13.5/13.6	3,250/2,820	Yes
HBL 546A UC	240/208	60	13.5/13.6	3,250/2,820	Yes

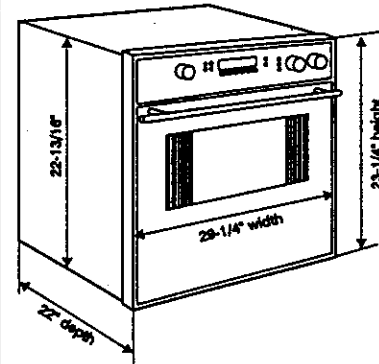

DOUBLE OVEN

For cutout dimensions see following sections titled:

Preparing Location

Double Oven Models	Electrical Ratings and Maximum Connected Load				Convection Oven (top/bottom)
	Volts	Hertz	Amperes @240V/208V	Watts @240V/208V	
HBL 552A UC	240/208	60	27.1/27.1	6,500/5,640	Yes/No
HBL 555A UC	240/208	60	27.1/27.1	6,500/5,640	Yes/No
HBL 556A UC	240/208	60	27.1/27.1	6,500/5,640	Yes/No
HBL 562A UC	240/208	60	27.1/27.1	6,500/5,640	Yes/Yes
HBL 565A UC	240/208	60	27.1/27.1	6,500/5,640	Yes/Yes
HBL 566A UC	240/208	60	27.1/27.1	6,500/5,640	Yes/Yes

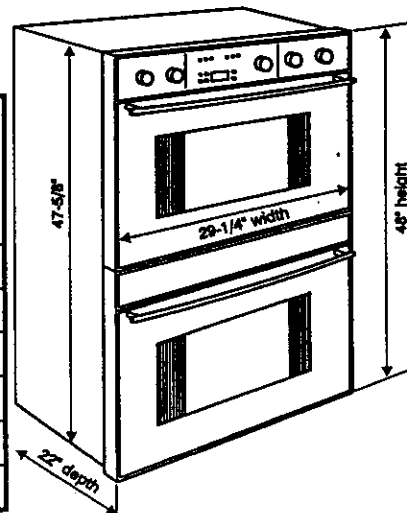

UNDERCOUNTER INSTALLATION, SINGLE

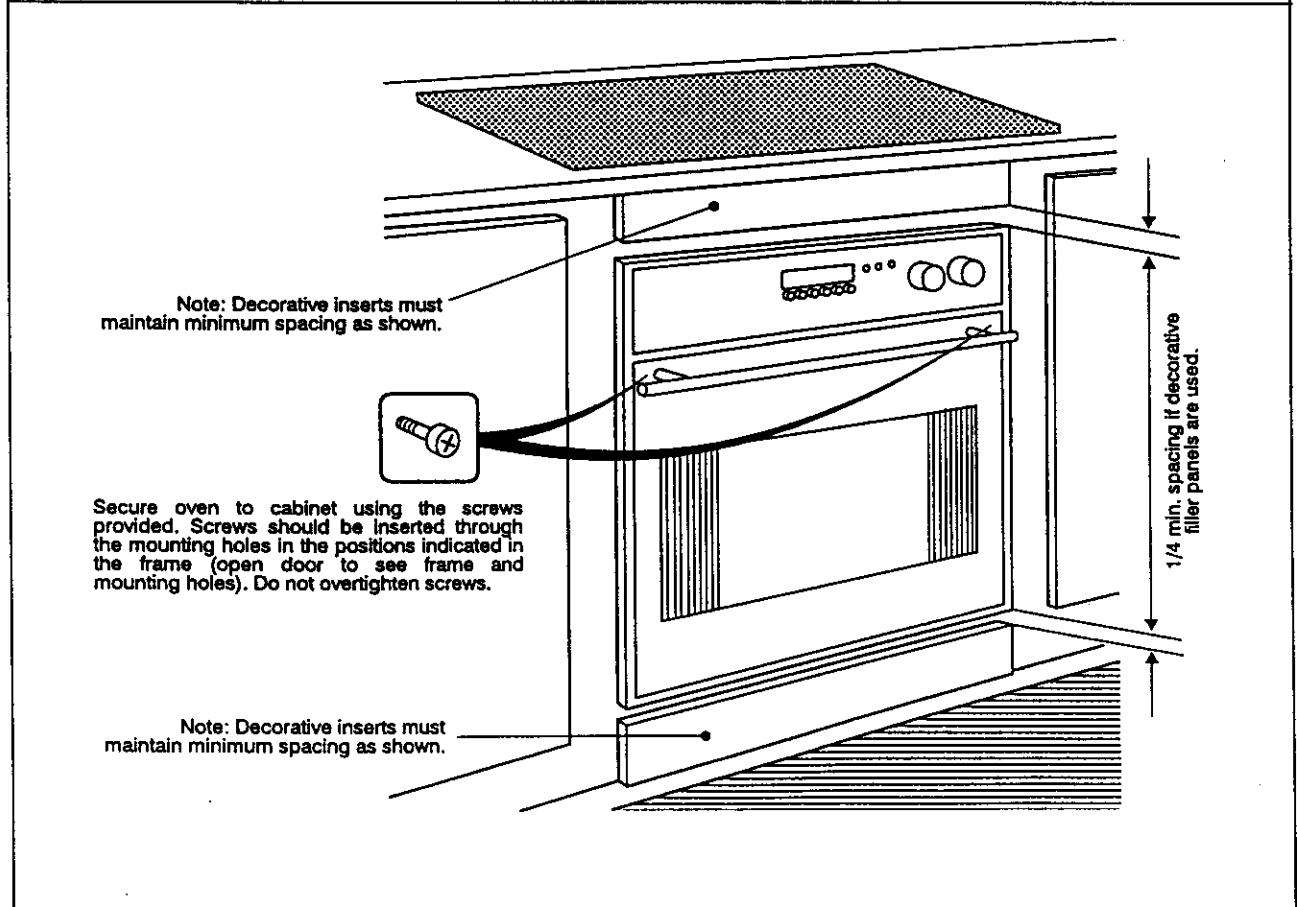
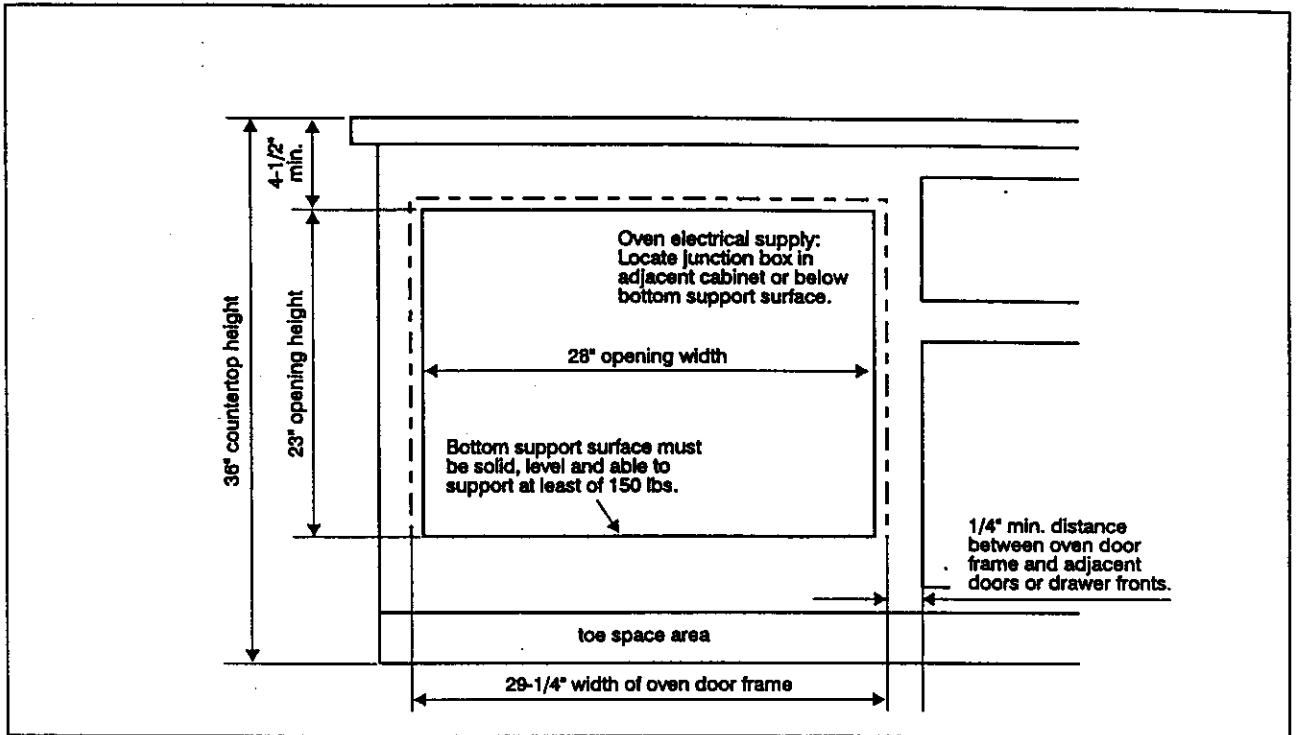

Refer to and follow Notes and Warning listed under **Wall Installation, Single Oven** (facing page)

WALL INSTALLATION, SINGLE OVEN

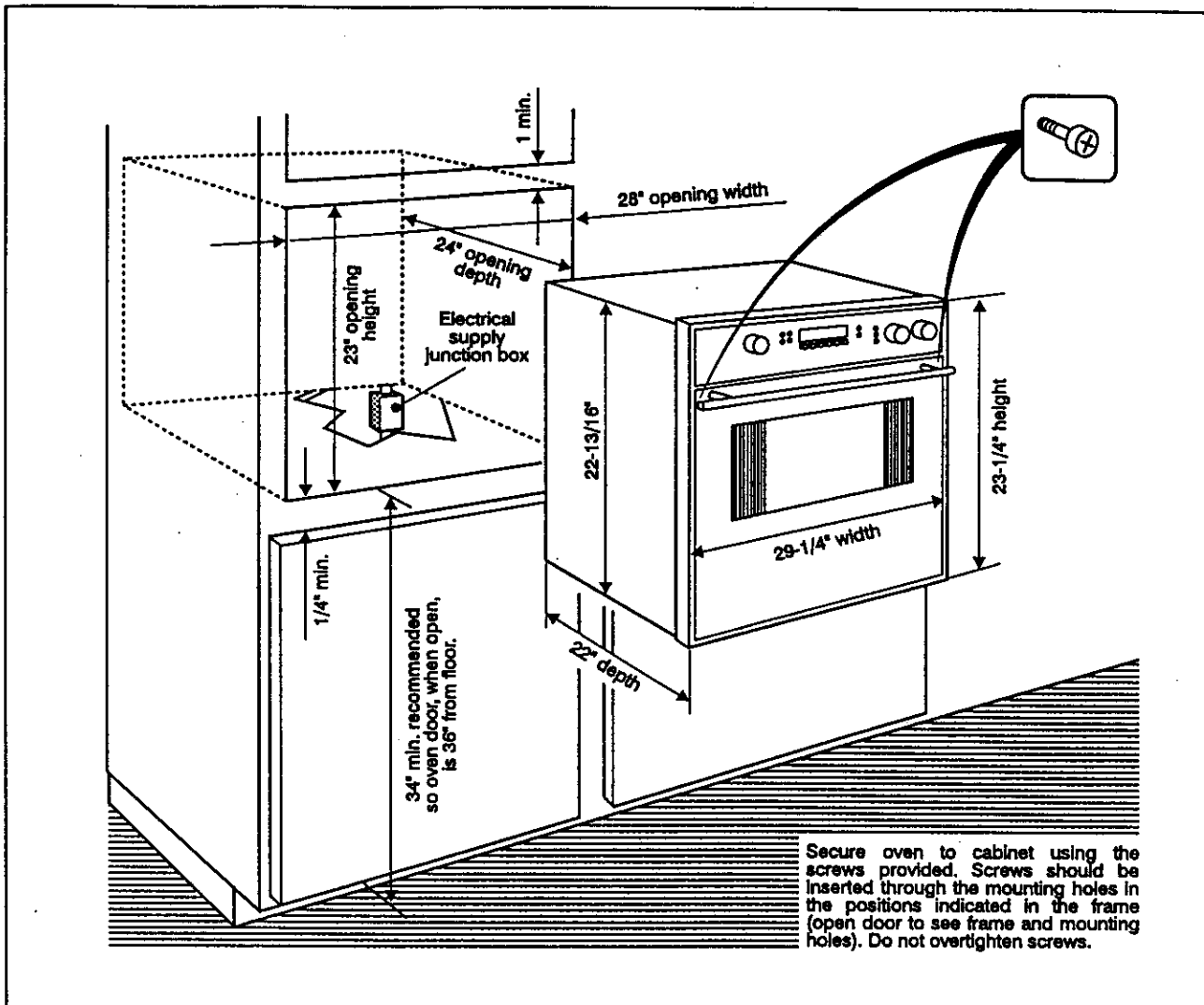

- Note:**
1. Do not slide oven across floor. Damage to floor covering or floor could result.
 2. The oven support surface must be a minimum 3/4" thick plywood platform, solid, level and flush with the bottom of the cabinet cutout.
 3. Use extreme caution when moving or installing the oven. It is very heavy.
 4. Be very careful when moving or installing the oven to avoid damage to the oven frame or damage to the cabinets.
 5. Be sure to level oven. An oven that is not level may provide poor or inconsistent baking results.

6. Be careful when placing oven. DO NOT pinch the conduit between the oven back or wall and the inner cabinet wall or floor.



WARNING

Securely fasten oven to cabinet using the screws provided. Failure to do so could result in oven moving or tipping during use and causing damage to the oven or cabinets or personal injury.

WALL INSTALLATION, DOUBLE OVEN

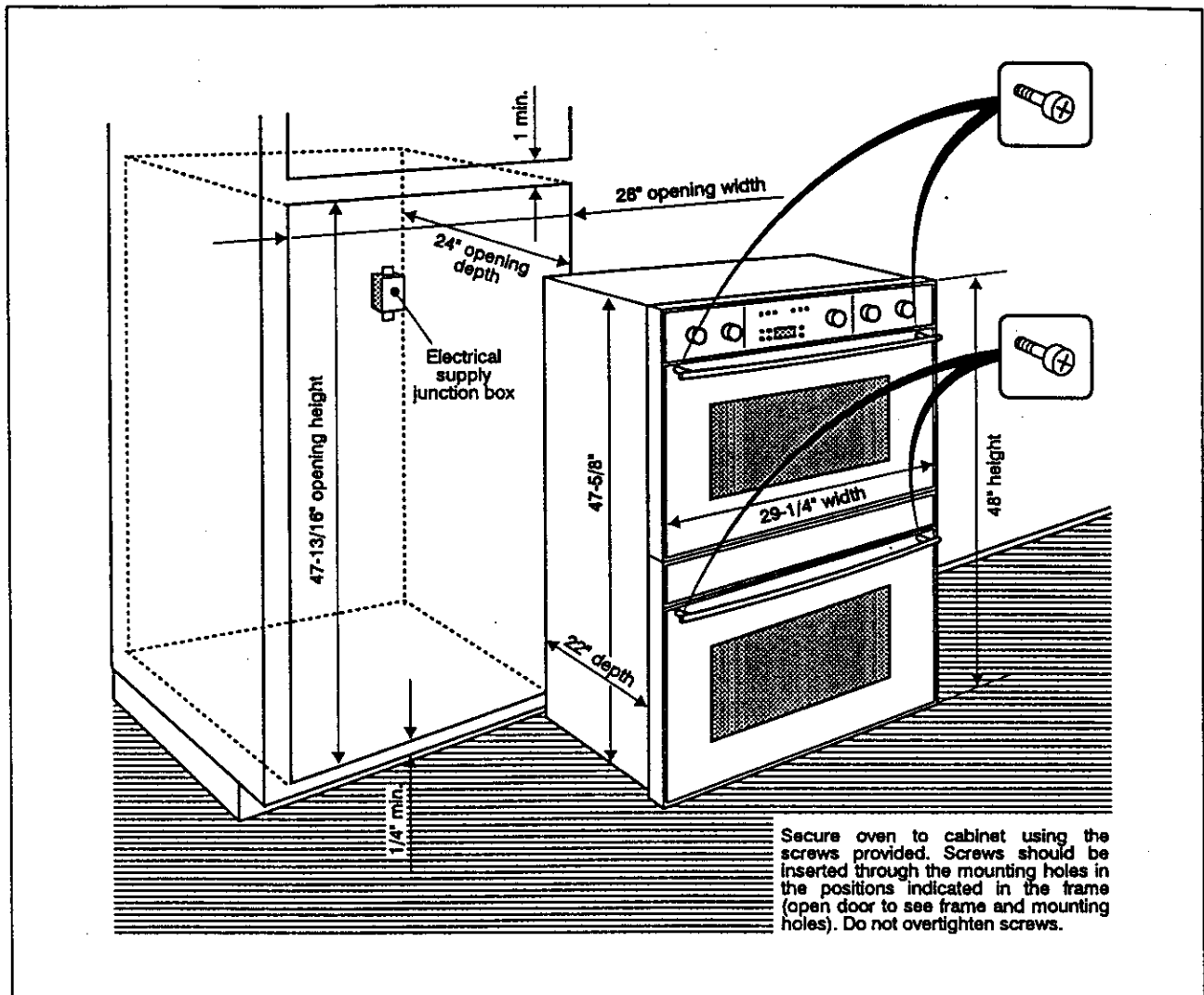

- Note:**
1. Do not slide oven across floor. Damage to floor covering or floor could result.
 2. The oven support surface must be a minimum 3/4" thick plywood platform, solid, level and flush with the bottom of the cabinet cutout.
 3. Use extreme caution when moving or installing the oven. It is very heavy.
 4. Be very careful when moving or installing the oven to avoid damage to the oven frame or damage to the cabinets.
 5. Be sure to level oven. An oven that is not level may provide poor or inconsistent baking results.

6. Be careful when placing oven. DO NOT pinch the conduit between the oven back or wall and the inner cabinet wall or floor.

WARNING

Securely fasten oven to cabinet using the screws provided. Failure to do so could result in oven moving or tipping during use and causing damage to the oven or cabinets or personal injury.

ELECTRICAL SUPPLY

Before installing the oven have a qualified electrician verify that your home is provided with adequate electrical service and that the addition of the oven will not overload the branch circuit on which it is to be installed. A separate three-wire or four-wire single phase, 240 Volt, 60 Hz., or a 208 Volt, 60 Hz. branch circuit is required.

Note: For use with 208 V, 60 Hz supply voltage the wiring must be modified as shown in **Connecting to 208 Volt Circuit.**

For hook-up of the oven you will need to have an approved junction box installed where it will be easily reached through the front of the cabinet where the oven will be located. The oven has 3 feet of conduit. Allow two to three feet of slack in the line so that the oven can be moved if servicing is ever necessary. **DO NOT** shorten the flexible conduit.



WARNING

ELECTRICAL SHOCK HAZARD

- The electrical power to the oven branch circuit must be shut off while line connections are being made.
- Do not use an extension cord with this appliance.
- Electrical ground is required on this appliance. The free end of the green wire (the ground wire) must be connected to a suitable ground.
This wire must remain grounded to the oven.
- If cold water pipe is interrupted by plastic, non-metallic gaskets, union connections or other insulating materials, **DO NOT** use for grounding.
- **DO NOT** ground to a gas pipe.
- **DO NOT** have a fuse in the **NEUTRAL** or **GROUNDING** circuit. A fuse in the **NEUTRAL** or **GROUNDING** circuit could result in an electrical shock.
- Check with a qualified electrician if you are in doubt as to whether the appliance is properly grounded.

Failure to follow these instructions could result in serious injury or death.

WIRING REQUIREMENTS

When making the wire connections, use the entire length of the conduit provided (3 feet). The conduit must not be cut.

Before making connections make sure the power is off and read and observe the following:

1. A separate three-wire or four wire, single phase, 240 Volt, 60 Hz. or 208 Volt, 60 Hz branch circuit is required for the oven.
2. The oven must be connected with **COPPER WIRE ONLY.**

3. In the United States:

Wiring must conform to the National Electrical Code, ANSI/NFPA No. 70 latest edition. You can obtain a copy of the National Electrical Code by writing:

National Fire Protection Association
Batterymarch Park
Quincy, MA 02269

In Canada:

Wiring must conform to Canadian Electrical Code C22.1- latest edition. You can obtain copies of the Canadian Electrical Code by writing:

Canadian Standards Association
178 Rexdale Boulevard
Rexdale (Toronto), Ontario, Canada
M9W 1R3

4. Wire size (**COPPER WIRE ONLY**) and connections must be suitable for the rating of the appliance per the National Electrical Code requirements. The flexible armored cable extending from the oven should be connected directly to the junction box.
5. The junction box should be located so as to allow as much slack as possible between the junction box and the oven so it can be moved if servicing is ever required.
6. A U.L. listed conduit connector must be provided at each end of the power supply cable.

CONNECTING TO 208 V CIRCUIT

The ovens are pre-wired for connection to 240 volt, 60 Hertz supply. If connecting to a 208 volt, 60 Hz. supply a jumper must be used across two terminals. For the double oven models there are two jumpers, one for the upper oven and one for the lower oven. For the single ovens there is one jumper.

Please refer to figures below for placement of jumper for 208 volt, 60 hertz connection.

To connect to 208 volt circuit:

- 1 Remove the access panel(s) located on the back of the oven(s).
- 2 Loosen the first and second screws in the terminal block as shown in applicable figure above.
- 3 Place the metal jumper between the first and second screws and tighten screws to hold jumper in place.
- 4 Replace access panel(s).

Placing of jumper for single oven or upper oven of double oven, for connection to 208 volt, 60 Hz.

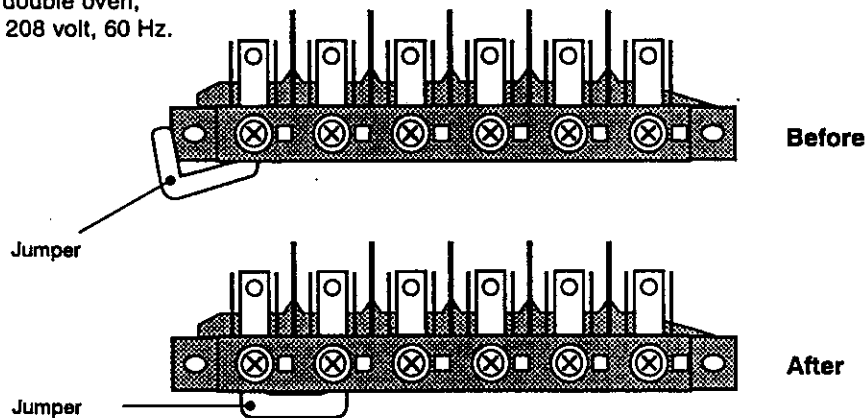

Placing of jumper for lower oven of double oven, for connection to 208 volt, 60 Hz.

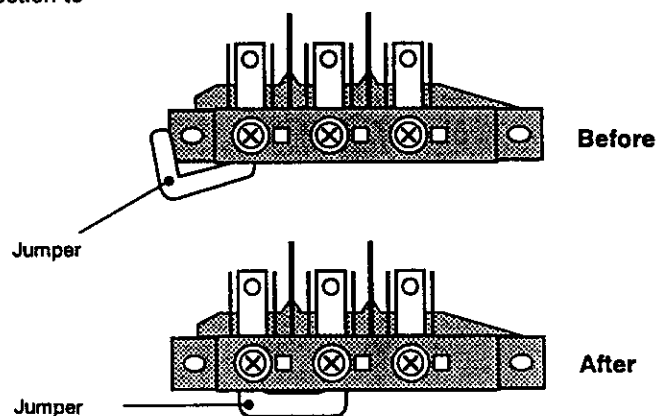

ELECTRICAL CONNECTIONS

This appliances is manufactured with a green GROUND wire connected to the oven chassis. After making sure that the power has been turned off connect the flexible conduit from the oven to the junction box using a U.L. listed conduit connector. Figures A and B and the instructions provided below present the most common way of connecting the ovens. Your local codes and ordinances, of course, take precedence to these instructions. Complete electrical connections according to local codes and ordinances.

3-WIRE BRANCH CIRCUIT

Refer to Figure A, where local codes allow the connection of GROUND wire from the cook-top to the branch circuit NEUTRAL wire (grey or white colored wire):

- If local codes permit, connect the green GROUND wire from the oven and the white wire from the oven to the branch circuit NEUTRAL wire (grey or white colored wire).
- Connect the red and black leads from the cook-top to the corresponding leads in the junction box.

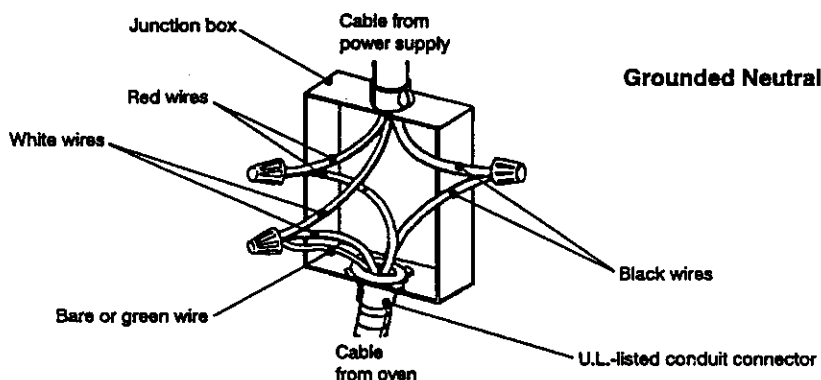

Figure A.

4-WIRE BRANCH CIRCUIT

Refer to Figure B:

- Connect the green GROUND wire from the oven to the GROUND wire in the junction box (bare or green colored wire).
- Connect the white wire from the oven to the NEUTRAL (grey or white) wire in the junction box.
- Connect the red and black leads from the oven to the corresponding leads in the junction box.

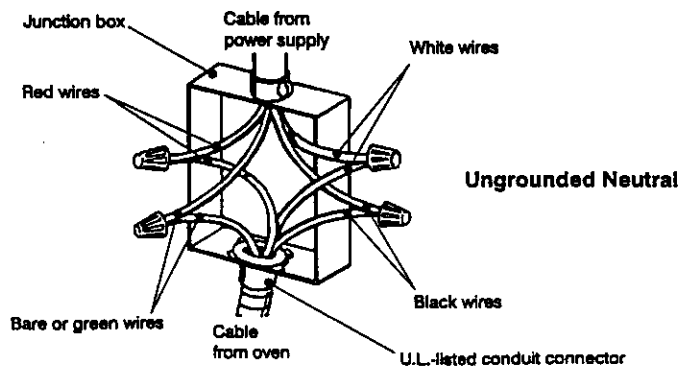
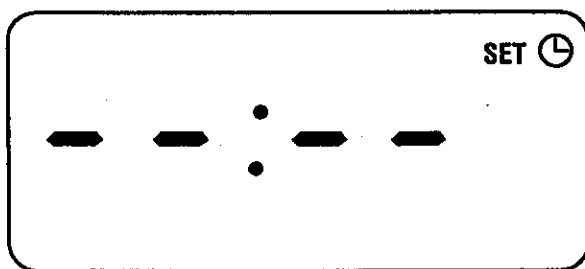

Figure B.

FINAL CHECK LIST

To prevent improper connections leading to damage of electrical components and so voiding the warranty, the following steps must be performed:

1. Check the electrical requirements and make sure you have the correct electrical supply and that the oven is properly grounded.
2. Make sure all control knobs are in the off position.
3. Turn on the power supply to the oven. When the oven is first turned on the display will come on showing all the call-outs and then will become blank with the Set Clock symbol in the upper right corner, as shown below.



4. Check power at the junction box wires using a volt meter having a range of 0-250 VAC. If you have installed the oven for use on 240 volt supply you should find that the voltage reading between the black and red wires (Line to Line) should be 220 to 240 volts. If you have modified the oven(s) for use on 208

volt the voltage reading between the black and red wires should be 190 to 208 volts.

5. Set the time of day by pressing the Set Clock button and pressing the plus (+) or minus (-) button, to the right of the display to set the correct time. Once the time is set depress the Set Clock button to enter the time. A "beep" will sound and the Set Clock symbol in the upper right will disappear.
6. Turn the Mode Selector knob to Manual position, the Selector knob to Bake and turn the Temperature knob to 350 °F. The cooling fan, the oven lights and the Preheat light should come on to indicate that the oven is heating. The Preheat light will turn off when the set temperature (350 °F) is reached. Turn Temperature knob to off. If you have installed a double oven repeat test for second oven.
7. To check the other oven functions refer to the Using the Oven Controls section of the Use and Care Manual.
8. If the oven is working properly turn the Selector knob(s) and the Temperature Control knob(s) to their off positions and press in the knobs so that they are flush with the oven and turn off the power supply to the oven.
9. Place the cover on the junction box and make sure the cover is securely fastened and turn on the power to the oven.
10. Leave these INSTALLATION instructions as well as the USE AND CARE MANUAL with the owner.