

KitchenAid®

*30" Built-In
Microwave-Convection Hood*

Model KHMC106W

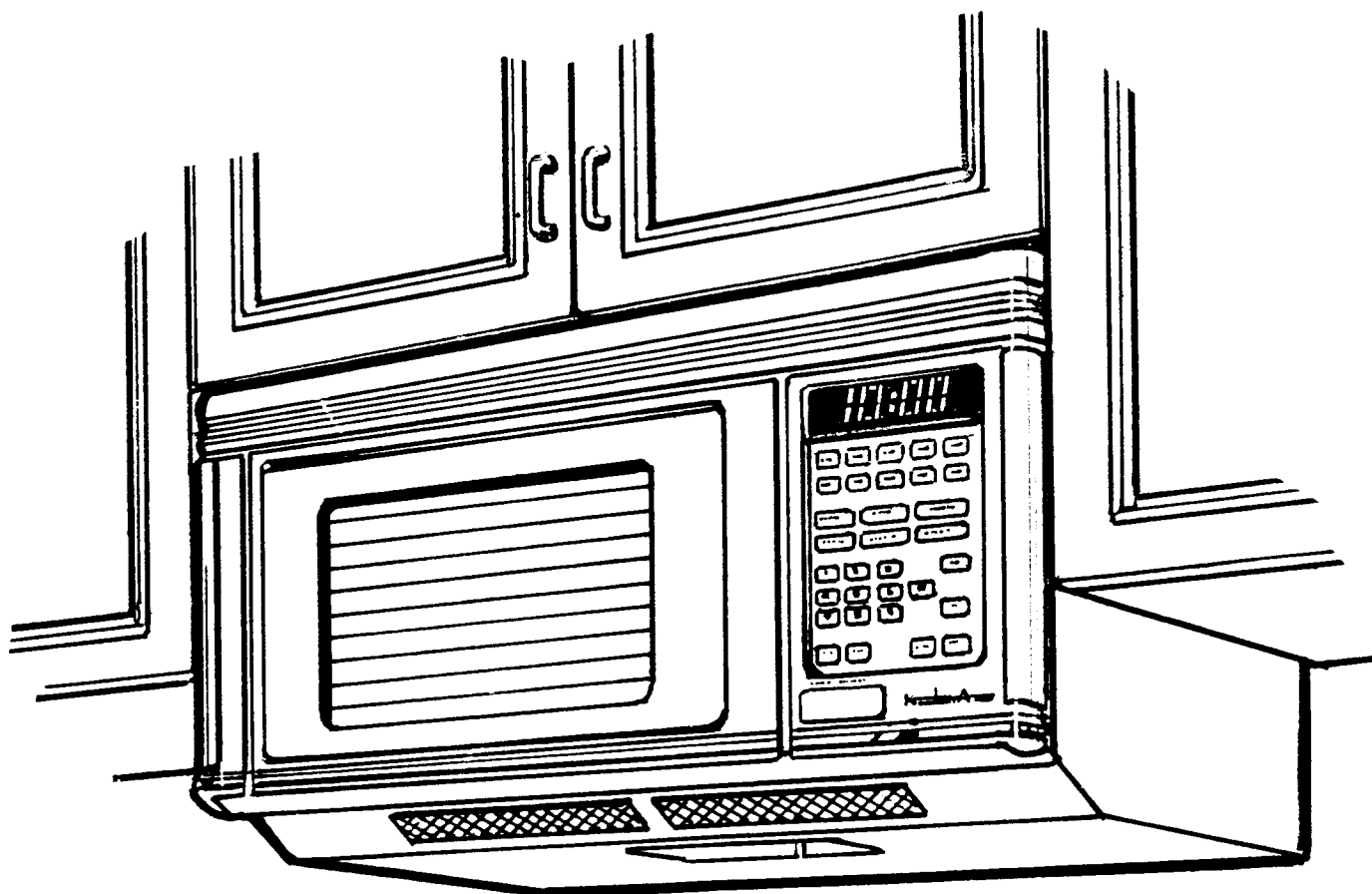

USE and CARE GUIDE

4174868

TABLE OF CONTENTS

Table of Contents.....	1	Convection and Automatic Mix Cooking.....	17
Specifications.....	1	To Cook with Convection without Preheating.....	18
Important Safety Instructions.....	2	To Cook with Automatic Mix without Preheating..	18
Before You Install Your Microwave-Convec-		To Preheat and Cook with Convection.....	19
tion Oven.....	3	To Preheat and Cook with Automatic Mix.....	20
Grounding Instructions.....	3	To Sequence Cook with Automatic Mix.....	20
Precautions to Avoid Possible Exposure to		Convection Cooking Using Temperature Probe....	21
Excessive Microwave Energy.....	4	Automatic Mix Cooking Using Temperature	
Owner Registration.....	4	Probe.....	21
Oven Features.....	5	Convection and Microwave Cooking.....	22
Touch Control Panel.....	6	Broiling.....	23
Accessories.....	6	Slow Cook.....	24
Operation of Touch Control Panel.....	7	Custom Cook.....	25
To Set the Clock.....	7	To Cook with Custom Cook.....	25
Kitchen Timer.....	8	Custom Cook Chart.....	26
Stop/Cancel	8	Auto Start.....	26
Easy Minute.....	8	Safety Precautions	27
Microwave Cooking.....	9	Condensation.....	27
Cooking by Time.....	9	Cleaning and Care.....	28
Pause.....	10	Service Call Check.....	30
Custom Defrost.....	10	Warranty.....	31
Custom Defrost Chart.....	12	How to Arrange for Service.....	31
Reheat.....	13		
Reheat Chart.....	13		
Temperature Probe Cooking.....	14		
To Cook with Temperature Probe.....	15		
To Monitor Temperature.....	15		
Sensor Temp.....	16		
Sensor Temp Chart.....	16		

© 1989 KitchenAid, Inc.

SPECIFICATIONS:

AC Line Voltage :	Single phase 120V, 60 Hz, A.C. only
AC Power Required:	1.6 kW (Microwave) 1.6 kW (Convection)
Output Power:	
Microwave	700 W (2000 cc water load), 2450 MHz
Convection Heater	1350 W
Outside Dimentions	29-7/8"(W), 16-1/2"(H), 15"(D)
Cavity Dimentions	13-5/8"(W), 8-3/8"(H), 13-1/2"(D)
Weight	Approx. 74 lbs.
Hood Lamp	2 lamps (40W x 2, incandescent lamp)
Hood Fan	Horizontal discharge 310 C.F.M., Vertical discharge 300 C.F.M.

In compliance with standards set by:

FCC - Federal Communications Commission Authorized

DHHS - Complies with Department of Health and Human Services (DHHS) Rule, CFR, Title 21, Chapter 1, Subchapter J.



- This symbol on the nameplate means the product is listed by Underwriter's Laboratories.

IMPORTANT SAFETY INSTRUCTIONS

Microwave convection ovens have been thoroughly tested for safe and efficient operation. However, as with any appliance, there are special installation and safety precautions which must be followed to ensure safe and satisfactory operation and prevent damage to the unit.

!WARNING

To reduce the risk of fire, electrical shock, injury to persons, or damage when using the microwave oven, follow basic precautions, including the following:

1. Read all instructions before using the appliance.
2. Visually check after unpacking:
Remove all packing material from the oven cavity.
Check the oven for any damage, such as misaligned door, damaged gaskets around door or dents inside the oven cavity or on the door. If there is any damage, please do not operate the oven until it has been checked by an Authorized KitchenAid Servicer and any repairs made, if necessary.
3. Read and follow the specific **"PRECAUTIONS TO AVOID POSSIBLE EXPOSURE TO EXCESSIVE MICROWAVE ENERGY"** on page 4.
4. This appliance must be grounded. Connect only to properly grounded outlet. See **"GROUNDING INSTRUCTIONS"** on page 3.
5. Install or locate this appliance only in accordance with the provided installation instructions.
6. Some products such as whole eggs and sealed containers - for example, closed glass jars - may explode and should not be heated in this oven.
7. Use this appliance only for its intended use as described in this manual.
8. As with any appliance, close supervision is necessary when used by children.
9. Do not operate this appliance if it has a damaged cord or plug, if it is not working properly, or if it has been damaged or dropped.
10. This appliance should be serviced only by qualified service personnel. Contact nearest Authorized KitchenAid Servicer for examination, repair or adjustment.
11. Do not block or cover any openings on the appliance.
12. Do not use outdoors.
13. Do not immerse cord or plug in water.
14. Keep cord away from heated surfaces.
15. Do not let cord hang over edge of table or counter.
16. See door surface cleaning instructions on page 28.
17. To reduce the risk of fire in oven cavity:
 - a. Do not overcook food. Carefully attend appliance if paper, plastic, or other combustible materials are placed inside the oven to facilitate cooking.
 - b. Remove wire twist-ties from paper and plastic bags before placing bag in oven.
 - c. If materials inside oven should ignite, keep oven door closed, turn oven off, and disconnect the power cord, or shut off power at the fuse or circuit breaker panel.
18. The appliance is specifically designed to heat or cook foods and is not intended for industrial or laboratory use. Do not attempt to heat corrosive chemicals in the microwave oven.
19. Because of the automatic exhaust fan feature, the following cautions must be observed:
 - a. Do not leave the area when using your cooktop at a high setting. Accidental fires from boilovers or splattering on the surface unit could spread, especially if the exhaust fan is operating.
 - b. Do not allow grease and soil to build up in the grease filter. Exhaust fan efficiency will decrease and fire may result. Clean often following the filter cleaning instructions on page 28.
 - c. Do not change the cooktop or oven lights without turning the power off at the main power supply, (see page 29). Electrical shock may result.
 - d. Do not flame foods on a cooktop surface below this unit. The fan, if operating, may spread the flame and cause personal injury or property damage.
20. Read and follow Safety Precautions on page 27.

Note: Never use ranges for space heating. This implies OK to use ranges as space heaters if no microwave oven above them.

SAVE THESE INSTRUCTIONS

Before you install your microwave convection oven

Read and carefully follow the **INSTALLATION INSTRUCTIONS** packed with your oven.

⚠ WARNING

Personal Injury Hazard

Failure to follow the installation instructions could lead to product malfunction or personal injury.

It is your responsibility to be sure your microwave oven:

- Has been installed where it is protected from the weather. **The microwave oven should be at a temperature above 50° F (10° C) for proper operation.**
- Has been properly connected to electrical supply and grounded.
(See Installation Instructions.)
- Is not used by children or anyone unable to operate it properly.
- Is properly maintained.
- Is used only for jobs expected of a home microwave oven.

GROUNDING INSTRUCTIONS

This appliance must be grounded. In the event of an electrical short circuit, grounding reduces the risk of electric shock by providing an escape path for the electric current. This appliance is equipped with a cord having a grounding wire with a grounding plug. The plug must be plugged into an outlet that is properly installed and grounded.

⚠ WARNING

Electrical Shock Hazard

Improper use of the grounding plug can result in a risk of electrical shock. DO NOT UNDER ANY CIRCUMSTANCES, REMOVE THE POWER SUPPLY CORD GROUNDING PRONG.

Consult a qualified electrician or serviceman if grounding instructions are not completely understood or if doubt exists as to whether the appliance is properly grounded.

If it is necessary to use an extension cord, use only a 3-wire extension cord that has a 3-blade grounding plug and a 3-slot receptacle that will accept the plug on the appliance. The marked rating of the extension cord should be AC 115-120 Volt, 15 Amp. or more.

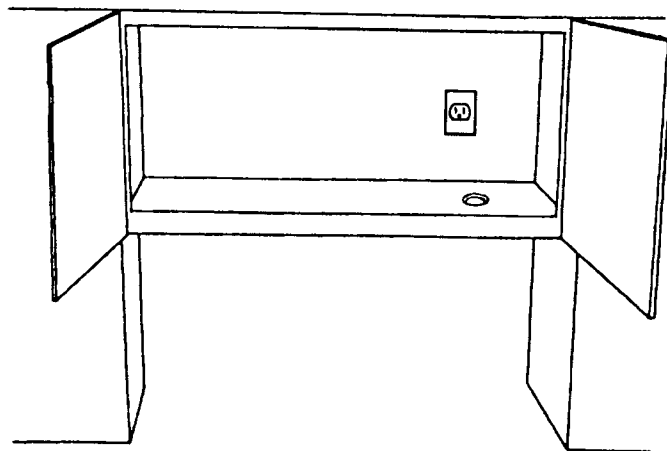

DO NOT UNDER ANY CIRCUMSTANCES CUT OR REMOVE THE ROUND GROUNDING PRONG FROM THE PLUG.

NOTE: If your electric power line or outlet voltage is less than normal 120 volts, cooking times may be longer.

OWNER REGISTRATION

Copy your Model and Serial Numbers here...

If you need service or call with a question, have this information ready:

1. **Complete** Model and Serial Numbers from the plate just behind the microwave oven door on the oven frame.
2. Purchase date from your sales slip.

Copy this information in these spaces. Keep this book, your warranty and sales slip together in a handy place. **Please complete and mail the Owner Registration Card furnished with this product.**

Model Number

Serial Number

Purchase Date

Service Company Phone Number

Fill out and return the "Microwave Registration Card" included with your oven. If the card is missing, please send the model number of your microwave oven with your name and address to...

KitchenAid, Inc.
701 Main St.
St Joseph, MI 49085

This information will help us reach you if there is ever a need to pass along information about your microwave oven.

PRECAUTIONS TO AVOID POSSIBLE EXPOSURE TO EXCESSIVE MICROWAVE ENERGY

- (a) Do not attempt to operate this oven with the door open since open-door operation can result in harmful exposure to microwave energy. It is important not to defeat or tamper with the safety interlocks.
- (b) Do not place any object between the oven front face and the door or allow soil or cleaner residue to accumulate on sealing surfaces.
- (c) Do not operate the oven if it is damaged. It is particularly important that the oven door close properly and that there is no damage to the:
(1) door (bent), (2) hinges and latches (broken or loosened), (3) door seals and sealing surfaces.
- (d) The oven should not be adjusted or repaired by anyone except properly qualified service personnel.
- (e) Do not operate the oven with the temperature probe caught between the oven front face and the door.

OVEN FEATURES

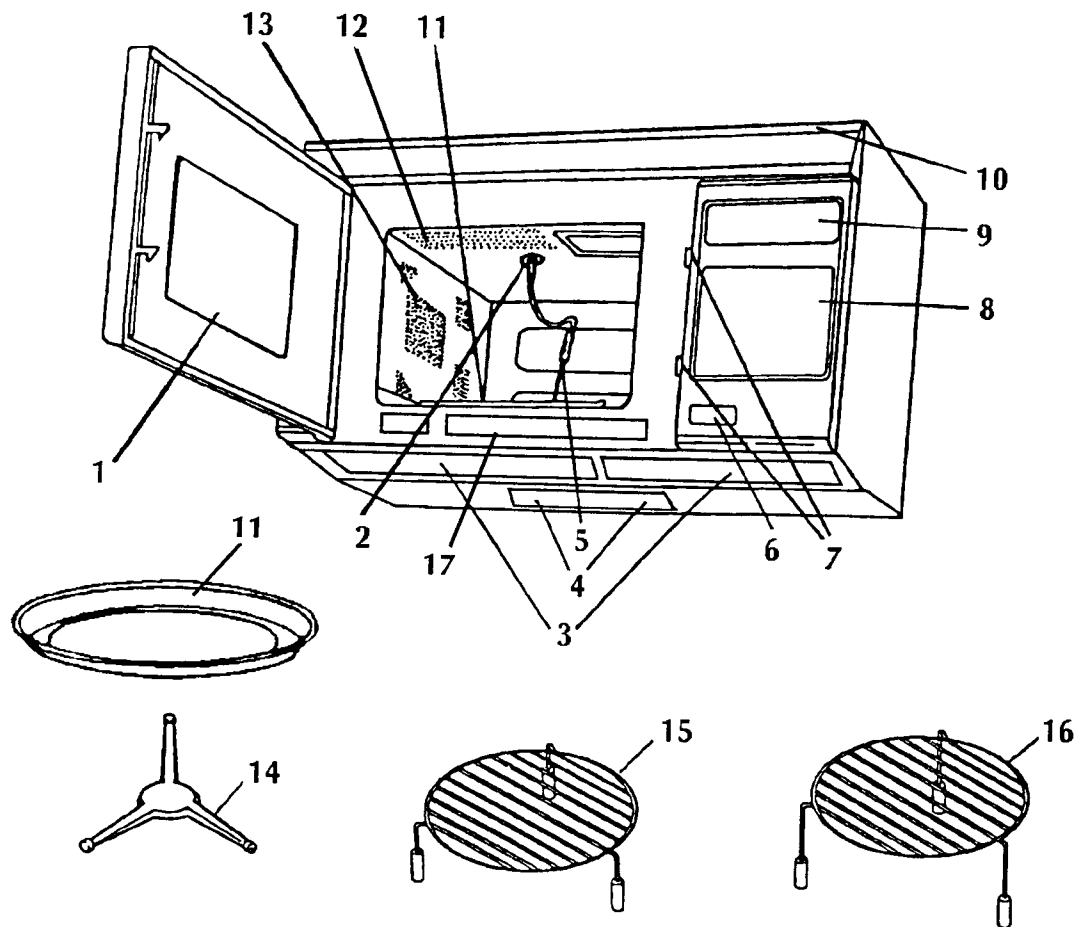

1. Oven door with see-through window.
2. Temperature probe receptacle.
3. Grease filters.
4. Hood lamps.
5. Removable temperature probe.
6. One touch door opener.
7. Door latches.
8. Touch control panel.
9. Lighted digital display.
10. Ventilation openings.
11. Removable turntable.
12. Oven lamp.
13. Convection air openings.
14. Turntable support. (It must be placed under the removable turntable.)
15. Broiling trivet.
16. Baking rack.
17. Quick Setting Guide.

TOUCH CONTROL PANEL

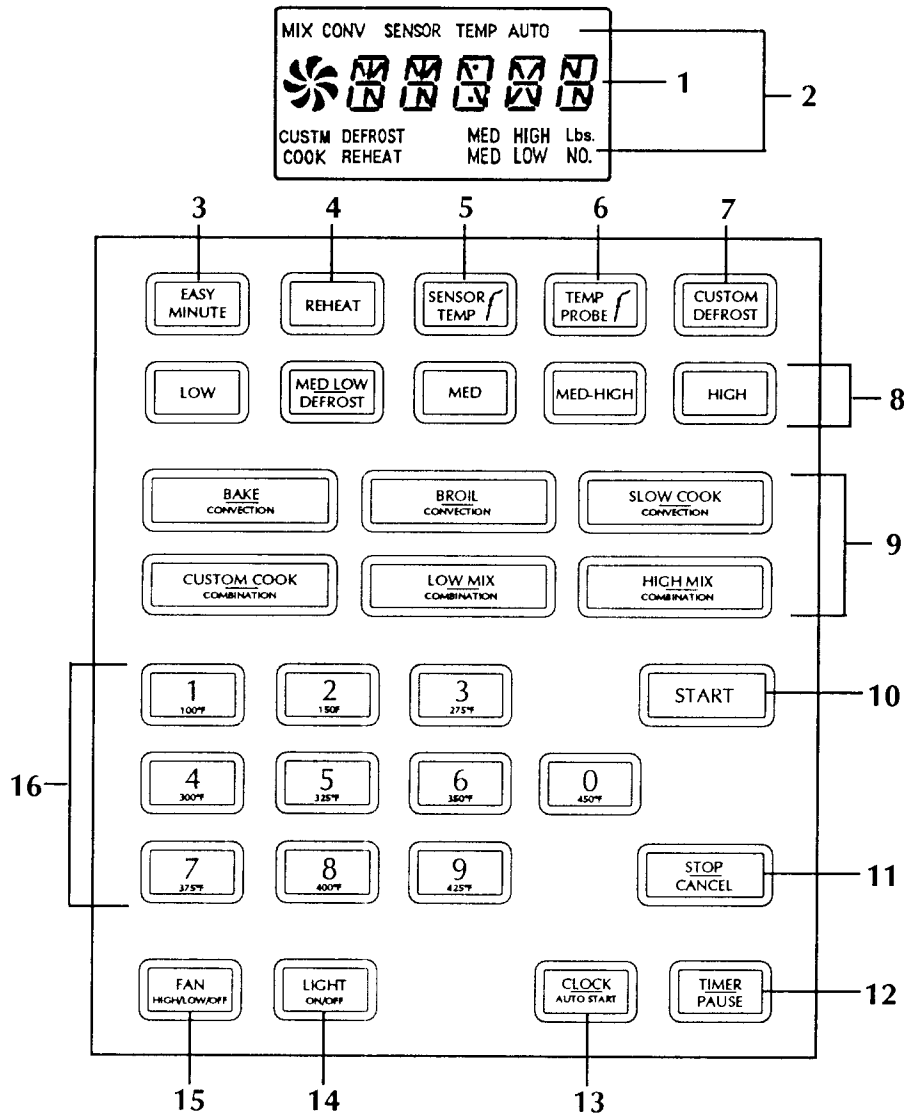

- ### FEATURES
1. Lighted digital display
 2. Indicators
 3. EASY MINUTE pad
 4. REHEAT pad
 5. SENSOR TEMP pad
 6. TEMP PROBE pad
 7. CUSTOM DEFROST pad
 8. Variable Cooking Control pads.
 9. Convection and Combination Cooking pads.
 10. START pad
 11. STOP/CANCEL pad.
 12. TIMER/PAUSE pad.
 13. CLOCK/AUTO START pad.
 14. HOOD LAMP pad. Push alternately for On and Off.
 15. FAN pad. Press once for High and twice for Low. Press again for Off.
 16. Number and Temperature selection pads.

ACCESSORIES

The following accessories are designed especially for use in this oven. The racks are for convection and combination cooking only; do not use for microwave cooking alone. Do not substitute similar types of racks for these specially designed ones.

Broiling Trivet

Used for roasting or broiling to allow juices to drain away from food.



Baking Rack

This rack is used for two-layer cooking, such as layer cakes, muffins, etc.

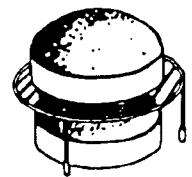

Operation of Touch Control Panel

Your new Touch Control microwave- convection oven uses a microprocessor, the electronic brain that provides a wide variety of cooking programs which could not be achieved by conventional control methods. The operation of the oven is controlled by touching the appropriate pads arranged on the surface of the control panel.

An entry signal tone should be heard each time you touch the control panel to make a correct entry. If you do not hear this sound:

- 1) You have not used enough pressure in touching the pad.
- 2) You have made more entries than the control panel will accept.
- 3) You have made an incorrect entry.





In addition to the entry signal tone, an audible signal will sound for approximately 2 seconds at the end of the cooking cycle.

After cooking or using the minute timer, the time of day will appear on the display.

- * Make sure the oven is plugged into a 3-pronged 115-120 volt household outlet. When the oven is plugged in, the display will show **88:88**, flashing on and off each second. Touch the STOP/CANCEL pad: **1:00** will appear.
- * You cannot program the oven if the door is not closed firmly.
- * This oven can be programmed for up to 4 automatic sequences. (EX.: Microwave Med - Microwave High - Pause - High Mix Roast)
- * During cooking, the program cannot be changed until the STOP/CANCEL pad is touched twice. All functions are locked in to prevent accidental changes.
- * During cooking, when the door is opened, the cooking time in the readout automatically stops. The cooking time starts to count down again when the door is closed and the START pad is touched.
- * If the electrical power to your microwave oven is interrupted, the display will intermittently show **88:88** after the power is reinstated. If this occurs during cooking, the program will be erased. Simply reset the clock for the correct time of day and reprogram.

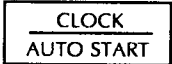
To Set the Clock

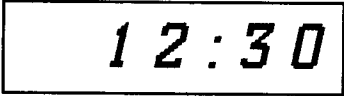
- * Suppose you want to enter the correct time of day 12:30 (A.M. or P.M.)

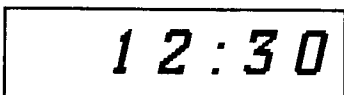
Step	Procedure	Pad Order	Display
1.	Touch the CLOCK/AUTO START pad.		
2.	Enter the correct time of day by touching the numbers in sequence.		
3.	Touch CLOCK/AUTO START pad again.		

- NOTE: 1. This is a 12 hour clock. **ERROR** will appear in the readout if you attempt to enter an incorrect clock time. For example, if you try to enter 8:61 or 13:00, **ERROR** and the incorrect clock time will appear repeatedly. To erase **ERROR**, touch the STOP/CANCEL pad. If you accidentally touch more than 4 number pads, the last 4 numbers you have touched will appear on the display.
2. If the oven is in cooking or minute timer mode and you wish to know the time of day, simply touch the CLOCK/AUTO START pad. As long as your finger is touching the pad, the time will be displayed. This checking operation does not interfere with the cooking time, oven temperature, or minute timer.

Kitchen Timer

The Timer/ Pause pad can be used as a timer for up to 99 minutes, 99 seconds. There is no cooking involved.

* Suppose you want to make a 3 minute long distance phone call.

Step	Procedure	Pad Order	Display			
1.	Enter desired time.	<table border="1" style="display: inline-table; vertical-align: middle;"> <tr> <td style="padding: 2px 10px;">3</td> <td style="padding: 2px 10px;">0</td> <td style="padding: 2px 10px;">0</td> </tr> </table>	3	0	0	3 00
3	0	0				
2.	Touch TIMER/PAUSE pad.	<table border="1" style="margin: auto;"> <tr> <td style="padding: 5px;">TIMER PAUSE</td> </tr> </table>	TIMER PAUSE	3 . 00		
TIMER PAUSE						

To cancel the minute timer during operation, touch the STOP/CANCEL pad and the time of day will reappear.

Stop/Cancel

Use the STOP/CANCEL pad to:

1. Erase if a mistake is made during programming.
2. Cancel minute timer.
3. Stop the oven temporarily during cooking.
4. Cancel a program during cooking, touch twice.

Easy Minute

Easy Minute allows you to cook for a minute at HIGH by simply touching the Easy Minute pad. You can also extend cooking time in multiples of 1 minute by repeatedly touching the Easy Minute pad during the cooking program of microwave, convection or combination cooking.

*Suppose you want to heat a cup of soup for one minute.

Step	Procedure	Pad Order	Display	
1.	Touch EASY MINUTE pad.	<table border="1" style="margin: auto;"> <tr> <td style="padding: 5px;">EASY MINUTE</td> </tr> </table>	EASY MINUTE	1 . 00
EASY MINUTE				

NOTE: 1. Easy Minute can only be entered within 1 minute after cooking, closing the door, touching STOP/CANCEL pad or during cooking. Easy Minute cannot be used to start the oven if any program is on the display.

2. The cooking time can be increased in multiples of 1 minute by repeatedly touching the Easy Minute pad during a cooking program of microwave, convection or combination cooking and during maintaining temperature with the probe. Easy Minute cannot be used with Reheat, Sensor Temp, Custom Defrost, CustomCook and Slow Cook.

MICROWAVE COOKING

Cooking by Time

There are five preset power levels:

Approximate percentage of microwave power for each power level:	
HIGH	100%
MED HIGH	70%
MED	50%
MED LOW/DEFROST	30%
LOW	10%

When using other than High, it is normal to hear the magnetron cycle on and off.

*Suppose you want to heat soup for 2 minutes 30 seconds at MEDIUM.

Step	Procedure	Pad Order	Display
1.	Enter desired cooking time.	<input type="button" value="2"/> <input type="button" value="3"/> <input type="button" value="0"/>	2 30
2.	Select desired variable cooking control setting.	<input type="button" value="MED"/>	2.30 MED
3.	Touch START pad.	<input type="button" value="START"/>	2.30 COOK MED

Your oven can be programmed for up to four sequences for cooking. First touch time and then the cooking mode. For example to program a second sequence of 1 minute 30 seconds at HIGH:

Step	Procedure	Pad Order	Display
3.	After step 2 above, enter desired time for the second cooking time.	<input type="button" value="1"/> <input type="button" value="3"/> <input type="button" value="0"/>	1 30
4.	Touch the desired variable cooking control setting..	<input type="button" value="HIGH"/>	1.30 HIGH
5.	Touch the START pad.	<input type="button" value="START"/>	2.30 COOK MED

NOTE: If you accidentally touch the wrong Variable Cooking Control pad, immediately touch the correct pad. The last pad touched will be the setting the oven accepts. For example, if you touch MED HIGH pad and then immediately touch MED pad, the oven will cook at MEDIUM. If HIGH is selected as the final sequence, it is not necessary to touch the HIGH pad. If HIGH is programmed as the first, second or third sequence, the HIGH pad must be touched.

Pause

PAUSE allows you to stop the oven between stages to stir, turn food over or add ingredients during the cooking process.

* Suppose you want to cook soup for 5 minutes at HIGH, stir and continue to cook for 3 minutes at MEDIUM.

Step	Procedure	Pad Order	Display
1.	Enter desired cooking time for the first stage.	<input type="text" value="5"/> <input type="text" value="0"/> <input type="text" value="0"/>	5 00
2.	Select desired variable cooking control setting. Touch HIGH pad..	<input type="text" value="HIGH"/>	5 .00 HIGH
3.	Touch TIMER/PAUSE pad.	<input type="text" value="TIMER
PAUSE"/>	PAUSE
4.	Enter desired cooking time for second stage.	<input type="text" value="3"/> <input type="text" value="0"/> <input type="text" value="0"/>	3 00
5.	Select desired variable cooking control setting. Touch MED pad for MEDIUM.	<input type="text" value="MED"/>	3 .00 MED
6.	Touch START pad.	<input type="text" value="START"/>	5 .00 COOK HIGH
7.	When the first stage finishes, an audible signal will sound 4 times and the oven will stop. Open door and stir soup.		PAUSE
8.	Close the door. <input type="text" value="PRESS"/> and <input type="text" value="START"/> will be displayed repeatedly. Touch START pad.	<input type="text" value="START"/>	3 .00 COOK MED



NOTE: PAUSE cannot be programmed as the first cooking sequence or used alone. If PAUSE is used as the first sequence, the oven will begin counting down as a minute timer.

Custom Defrost

Your oven has special function keys to defrost meats and poultry faster and better. Custom Defrost automatically defrosts roast beef, pork, steaks, chops, ground meat, whole chicken and chicken pieces. Each key has 3 defrosting stages.

* Suppose you want to defrost a 2 lb. steak with Custom Defrost.

Step	Procedure	Pad Order	Display
1.	Touch CUSTOM DEFROST pad.	<input type="text" value="CUSTOM DEFROST"/>	F 0 0 0 CUSTOM DEFROST
2.	Select desired Custom Defrost setting. Touch 2 to defrost steak.	<input type="text" value="2"/>	CD - 2 CUSTOM DEFROST Lbs. Lbs. will flash on and off

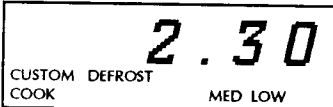
Step	Procedure	Pad Order	Display
3.	Touch the number pads to enter weight.	<input type="text" value="2"/> <input type="text" value="0"/>	 <p>Lbs. stops flashing and remains on display.</p>
4.	Touch the START pad.	<input type="text" value="START"/>	 <p>When the 1st stage finishes, an audible signal will sound 4 times and oven will stop. <input type="text" value="TURN"/> <input type="text" value="OVER"/> and <input type="text" value="COVER"/> <input type="text" value="EDGE"/> will be displayed repeatedly.</p>
5.	Open the door. Turn steak over and shield any warm portions. Close the door.		<input type="text" value="PRESS"/> and <input type="text" value="START"/> will be displayed repeatedly.
6.	Touch the START pad.	<input type="text" value="START"/>	 <p>When the second stage finishes, an audible signal will sound 4 times and oven will stop. <input type="text" value="LOOK"/> <input type="text" value="COVER"/> <input type="text" value="EDGE"/> will be displayed repeatedly.</p>
7.	Open the door. Shield any warm portions. Close the door.		<input type="text" value="PRESS"/> and <input type="text" value="START"/> will be displayed repeatedly.
8.	Touch the START pad.	<input type="text" value="START"/>	 <p>When the 3rd stage finishes, an audible signal will sound. <input type="text" value="COVER"/> and <input type="text" value="STAND"/> will be displayed continuously.</p>

Open door or touch STOP/CANCEL pad. The time of day will reappear on the display.

NOTE:

1. The weight can be entered in 0.1 lb. increments. Pounds must be rounded off to the nearest tenth of a pound. (Example: 1.75 lbs. should be rounded off to 1.8 lbs.)
2. Foods weighing more or less than the quantity listed in the chart should be defrosted following the guidelines in the cookbook. If an incorrect weight is entered and the START pad is touched, and the incorrect weight will be displayed repeatedly. The STOP/CANCEL pad has to be touched to reprogram the oven.
3. Elevate whole chicken or roast on a microwave safe rack or inverted saucer set on a microwave safe utility dish. Defrost roasts with the fat side down; turn over when the oven signals.

Custom Defrost Chart

Setting	Food	Quantity	Display	Procedure	Time
1	Roast Beef, Pork	2.5 to 6.0 lbs.	TURN OVER COVER EDGE LOOK COVER EDGE	* After the 1st stage, turn over and shield the warm portions with aluminum foil. *After the 2nd stage, if there are warm portions, shield with aluminum foil.	Let stand, covered, 30-45 minutes
2	Steaks Chops Fish	0.5 to 4.0 lbs.	TURN OVER COVER EDGE LOOK COVER EDGE	* After the 1st stage, turn over and shield the warm portions with aluminum foil. *After the 2nd stage, if there are warm portions, shield with aluminum foil.	Let stand, covered, 10-15 minutes.
3	Ground meat	0.5 to 3.0 lbs.	PULL APART RE- MOVE	*Remove any thawed pieces after each stage.	Let stand, covered, 5-10 minutes.
4	Chicken, whole	2.5 to 6.0 lbs.	TURN OVER COVER EDGE LOOK COVER EDGE	* After the 1st stage, turn over and shield the warm portions with aluminum foil. *After the 2nd stage, if there are warm portions, shield with aluminum foil.	Remove giblets before freezing poultry. Let stand covered, 30-55 minutes.
5	Chicken pieces	0.5 to 3.0 lbs.	PULL APART RE- ARRNG RE- ARRNG COVER EDGE	* After the 1st stage, turn over and rearrange. *After 2nd stage, if there are warm or thawed portions, rearrange or remove.	Let stand, covered, 10-15 minutes.

NOTE: Check foods when oven signals. After the final stage, small sections may still be icy. Let stand to continue thawing. Do not cook until all ice crystals are thawed.







Shielding roasts and steaks prevents cooking from occurring before the center of the food is defrosted.

Use small strips of aluminum foil to shield edges and thinner sections of the food.

Reheat

The Reheat feature allows you to reheat many of your favorite foods automatically without setting the time or power level.

*Suppose you want to reheat a dinner plate.

Step	Procedure	Pad Order	Display
1.	Touch REHEAT pad.		
2.	Select desired REHEAT setting. Touch 2 to reheat dinner plate.		
3.	Touch START pad.		

The cooking time will count down to zero. When the timer reaches zero, all indicators will go out and an audible signal will sound. The time of day will reappear on the display.

Reheat Chart

Setting	Food	Quantity	Procedure	Time*
1	Roll, Muffin	1 medium	Wrap in paper towel.	15 sec.
2	Dinner plate	1 plate	Place meaty portions and bulky vegetables to outside of dish. Cover with waxed paper.	3 mins.
3	Vegetables	1 cup	Cover; stir before serving.	1 mins. 50 secs.
4	Casserole	1 cup	Cover; stir before serving.	3 mins.
5	Soup	1 cup	Cover; stir before serving.	2 mins. 30 secs.

*Times are given for your reference, when you select Reheat, the heating time will appear on display and countdown. You can use these settings for other foods you may prepare.

NOTE: 1. Foods can be covered with waxed paper or vented plastic wrap. Temperature of foods covered with plastic wrap tend to be slightly higher than those covered with waxed paper.
2. When placing casserole on plate for reheating, pat with spoon to 1 to 1 1/2 inches thick.
3. Slice meat for reheating on dinner plate.
4. Stir items after removing from oven, if possible.

Temperature Probe Cooking

Your oven is equipped with a removable temperature probe. Suggested cooking and serving temperatures are given throughout the cookbook. Please refer to the beginning of each chapter and to individual recipes for temperature guidelines.

To Use the Temperature Probe

1. Insert the pointed metal thermometer portion (B) of the temperature probe into the food. It is easier to position the probe correctly if this is done while the food is outside the oven. Be sure to insert the probe at least 2/3 of the length of the thermometer portion (B) into the food. For casseroles, place the thermometer in the center of the food. When cooking meats, insert in the center of the meatiest portion away from bone or fatty sections. For poultry, insert the probe between the inner thigh and the body of the bird.
2. Place the food on the turntable inside the oven.
3. Insert the probe plug (A) into the receptacle in the top center of the oven cavity (ceiling of the oven). Be sure the probe is securely inserted. This portion rotates as the food turns on the turntable.
4. Avoid placing the rubber cord (C) directly on or in the food.
5. Program the oven for cooking by temperature or with Sensor Temp. When the food reaches the programmed temperature, the oven will turn off automatically. Reposition the probe to check temperature. Repeat the same program. If the temperature is low, cooking will continue until the correct temperature is reached. If the temperature is correct, the oven will shut off. The time of day will reappear on the display.
6. Remove the probe plug from the receptacle before removing the food from the oven.

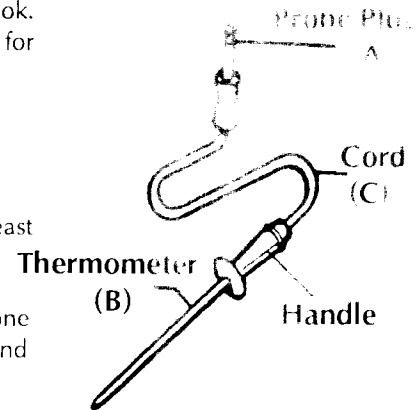

⚠ WARNING

Burn Hazard

Oven and probe may be hot. Use a potholder to remove the probe. Failure to do so could result in burns.

Use and Care of Temperature Probe

1. DO NOT OPERATE THE OVEN EMPTY WITH THE TEMPERATURE PROBE INSIDE. TO AVOID THIS POSSIBILITY, DO NOT LEAVE THE PROBE IN THE OVEN WHEN NOT IN USE.
2. The temperature probe should be unplugged and removed from the oven when not in use. Store the probe in a safe, convenient place outside the oven.
3. Carefully wash the temperature probe in warm sudsy water and wipe dry.
4. The temperature probe should never be allowed to touch the interior walls or door of the oven.
5. Do not use the temperature probe when using a browning dish.
6. This temperature probe is designed specifically for use in this oven. Do not substitute any other probe for this one. The probe cannot be used in other microwave ovens.
7. Avoid harsh treatment of the probe. Do not drop the probe. It is a thermometer. Handle it carefully.
8. Potholders may be needed when removing the temperature probe.
9. Do not remove the probe from the receptacle or from the food by pulling on the cord. Use the insulated handle.
10. Do not try to force the temperature probe into solidly frozen food.
11. Temperatures are displayed in the range of 90°F to 230°F. The maximum temperature which can be entered is 200°F. If a temperature more than 200°F or less than 90°F is set, **ERROR** and the incorrect temperature will appear on the display. The STOP/CANCEL pad must be touched in order to reprogram the oven.
12. Temperature readings are given for some recipes which should be cooked covered. If you wish to use the probe, cover the food with clear plastic wrap and insert the probe through the plastic wrap.
13. You will often notice a change in the temperature after stirring. This is normal and occurs in conventional cooking also.
14. Recommended cooking or serving temperatures are given for those recipes in your cookbook where cooking by temperature is appropriate. You may choose to cook by either time or temperature.

To Cook with Temperature Probe

* Suppose you want to roast a chicken to 180°F at MEDIUM HIGH.

Step	Procedure	Pad Order	Display
1.	Place probe in chicken. Insert probe plug into the receptacle in the top center of the oven cavity. Enter desired temperature.	1 8 0	1 8 0
2.	Touch TEMP PROBE pad to select temperature cooking.	TEMP PROBE	TEMP 1 8 0 F
3.	Select desired variable cooking control setting. Touch MED HIGH pad.	MED HIGH	TEMP 1 8 0 F MED HIGH
4.	Touch START pad. When food temperature is lower than 90°F, LO F will be displayed. When the internal temperature reaches 90°F, the readout will display the actual temperature of the food as it increases to 180°F. When it reaches 180°F as detected by the temperature probe, the oven will automatically shut off.	START	TEMP L O F COOK MED HIGH

Your oven can be programmed to maintain any temperature from 90°F to 200°F for up to 99 minutes 99 seconds. This feature can be used to keep food warm at the desired serving temperature until you are ready to eat, or food can be simmered at a specific temperature for up to 99 minutes 99 seconds.

* If you want to maintain exactly 180°F for 20 minutes in the above example.

Step	Procedure	Pad Order	Display
4.	After step 3, enter desired cooking or "holding" time. To maintain 180°F for 20 minutes.	2 0 0 0	2 0 0 0
5.	Touch START pad.	START	As with the above example, when food temperature is lower than 90°F, LO F will be displayed.

In the above example, if the actual temperature drops below 180°F during the 20 minute "holding" time, microwave energy will come on long enough to boost the temperature back up to 180°F.

NOTE: 1. If the temperature probe is not plugged in properly or is defective, TEMP indicator will flash on and off. When you touch START, TEMP will remain. PROBE will flash on the display, and oven will not turn on.

2. If you are in the process of cooking using the temperature probe and wish to check the temperature you have programmed, simply touch the TEMP pad. As long as your finger is touching the TEMP pad., the programmed temperature will be displayed.

To Monitor Temperature

If the temperature probe is plugged into the top center of the oven cavity and the probe is placed in water or food, the temperature of the water or food can be monitored on the readout. Touch the TEMP pad. Temperature detected by temperature probe will appear on display. (90°F to 230°F will be displayed.) To return to the time of day, touch the STOP/CANCEL pad.

Sensor Temp

Sensor Temp settings 1-6 automatically cook roasts, poultry and casseroles to an exact internal doneness. The finished temperatures are already calculated.

Sensor Temp setting 7 is used for slow cooking. Sauces, stews or meats that benefit from slow cooking can be done very easily. It will bring the food quickly up to temperature and maintain it for up to 4 hours.

*Suppose you want to cook a beef roast to medium doneness.

Step	Procedure	Pad Order	Display
1.	Place probe in meat. Put meat in the oven. Insert probe plug into the receptacle in the top center of the oven cavity. Close the door. Touch the SENSOR TEMP pad.	SENSOR TEMP	SENSOR TEMP FOOD
2.	Select desired Sensor Temp setting. Touch 2 to cook roast to medium.	2	MIX SENSOR TEMP ST - 2
3.	Touch the START pad. When the internal temperature reaches 100°F, the readout will display the actual temperature of the food as it increases to 130°F. The oven will automatically shut off and COVER and STAND will be displayed repeatedly.	START	MIX SENSOR TEMP ST - 2 COOK

Open oven door or touch STOP/CANCEL pad. The time of day will reappear on the display.

NOTE: If you touch the wrong Sensor Temp setting, retouch the correct setting.

Sensor Temp Chart

Place roasts and turkey breasts on broiling trivet. Place shallow glass baking dish under the meat if you want to save drippings for gravy. Using small strips of aluminum foil, shield edges of roasts from beginning to assure perfect results. Foil strips should not touch probe or rack. Select Sensor Temp setting. Oven will signal when final temperature is reached. Reposition probe and reprogram. If the temperature is low, cooking will continue until temperature is reached. If temperature is correct, the oven will shut off.

Food	Setting	Internal Temperature	Comments	Cooking Mode
Roast beef (rare)	1	120°F	Stand, covered, 10 min.	HIGH MIX 325°F
Roast beef (medium)	2	130°F	Stand, covered, 10 min.	HIGH MIX 325°F
Roast beef (well done)	3	150°F	Stand, covered, 15 min.	HIGH MIX 325°F
Roast pork	4	170°F	Stand, covered, 10 min.	HIGH MIX 325°F
Turkey breast	5	170°F	Stand, covered, 10 min.	HIGH MIX 325°F
Casserole with cooked ingredients	6	160°F	Cover with lid or plastic wrap	MICROWAVE
Simmer (sauces, stews)	7	180°F	Hold for a maximum of 4 hr.*	MICROWAVE

* If you want to simmer food for less than 4 hours, stop oven after desired simmer time.

Convection and Automatic Mix Cooking

This section of the Operation Manual gives you helpful hints for convection and combination cooking. Please consult your KitchenAid Convection Microwave Cookbook for more specific cooking instructions and procedures.

Recommended Utensils:

Metal turntable
Baking Rack
Broiling trivet
Metal baking pans

Aluminum foil containers
Heat resistant glass
Glass Ceramic cookware

Ovenable paper board containers (follow manufacturer's instructions)

⚠ WARNING

Burn Hazard

- Use oven mitts to remove hot cooking utensils and hot oven racks to prevent burns. The interior surfaces of the oven will be hot.
- Use cooking utensils that will not melt or burn in the hot oven. Do not use light plastic containers, plastic wraps or paper products during any convection or combination cycle.

Convection Cooking

During convection heating, hot air is circulated throughout the oven cavity to brown and crisp foods quickly and evenly. This oven can be programmed for ten different convection cooking temperatures for up to 99 minutes 99 seconds.

The oven should not be used without the turntable in place, and it should never be restricted so that it cannot rotate. You may remove the turntable when preheating the oven and when preparing food to be cooked directly on the turntable.

Helpful Hints:

1. Foods may be cooked either directly on the turntable or with the rack or trivet on the turntable.
2. Do not cover turntable, broiling trivet or baking rack with aluminum foil. It interferes with the flow of air that cooks the food.
3. Round pizza pans are excellent cooking vessels for many convection-only items. Choose pans that do not have extended handles.
4. Hot dogs cooked on the broiling trivet may be turned over to give an even, grilled appearance.

Automatic Mix Cooking:

This oven has two preprogrammed settings that make it easy to cook with both convection heat and microwave automatically.

With the exception of those foods that cook best by convection heating alone, most foods are well suited to mix cooking using either LOW MIX/BAKE or HIGH MIX/ROAST.

The marriage of these two cooking methods produces juicy meats, moist and tender cakes, and fine textured breads, all with just the right amount of browning and crispness.

Helpful Hints:

1. Meats may be roasted directly on the broiling trivet or in a shallow roasting pan on the trivet on the turntable.
2. Less tender cuts of beef can be roasted and tenderized using oven cooking bags.
3. When baking, check for doneness after time has elapsed. If not completely done, let stand in oven for a few minutes to complete cooking.

NOTE:

During mix baking some metal baking utensils may cause arcing when they come in contact with the turntable, oven walls or metal accessory racks. Arcing is a discharge of electricity that occurs when microwaves come in contact with metal. If arcing occurs, place a heat resistant dish (glass pie plate, glass pizza dish or dinner plate) between the pan and the turntable or trivet. If arcing occurs with other baking utensils, discontinue their use for combination cooking.

To Cook with Convection without Preheating

*Suppose you want to cook at 350°F for 20 minutes.

Step	Procedure	Pad Order	Display
1.	Enter desired cooking time.	<input type="text" value="2"/> <input type="text" value="0"/> <input type="text" value="0"/> <input type="text" value="0"/>	
2.	Touch CONVECTION pad.	<input type="text" value="CONVEC"/>	
3.	Enter desired temperature.	<input type="text" value="6"/> 350°F	
4.	Touch START pad.	<input type="text" value="START"/>	

NOTE: Convection temperatures are entered by touching the pad with the temperature indicated below the number. (Ex: For 350°F, touch the number 6 pad.)

If you are cooking with convection or automatic mix and you wish to check the temperature you have programmed, simply touch the CONVECTION pad. The programmed temperature will be displayed as long as the CONVECTION pad is touched.

To Cook with Automatic Mix without Preheating

*Suppose you want to bake a cake for 20 minutes on LOW MIX/BAKE.

Step	Procedure	Pad Order	Display
1.	Enter desired cooking time.	<input type="text" value="2"/> <input type="text" value="0"/> <input type="text" value="0"/> <input type="text" value="0"/>	
2.	Touch LOW MIX/BAKE pad.	<input type="text" value="LOW MIX
BAKE"/>	
3.	Touch START pad.	<input type="text" value="START"/>	

NOTE: To cook on HIGH MIX/ROAST setting, use above procedure, touching HIGH MIX/ROAST pad in Step 2.

*Suppose you want to bake a double crust pie for 30 minutes on HIGH MIX/ROAST at 400°F (change temperature).

Step	Procedure	Pad Order	Display
1.	Enter desired cooking time.	<input type="text" value="3"/> <input type="text" value="0"/> <input type="text" value="0"/> <input type="text" value="0"/>	
2.	Touch HIGH MIX/ROAST pad.	<input type="text" value="HIGH MIX ROAST"/>	
3.	Enter desired temperature.	<input type="text" value="8"/> 400°F	
4.	Touch START pad.	<input type="text" value="START"/>	

To Preheat and Cook with Convection

Your oven can be programmed to combine preheating and convection cooking or preheating and automatic mix cooking operations. You can preheat at the same temperature as the convection temperature or the automatic mix temperature or change it to a higher or lower temperature.



*Suppose you want to preheat the oven to 325°F then cook for 20 minutes at 325°F.

Step	Procedure	Pad Order	Display
1.	Touch CONVECTION pad.	<input type="text" value="CONVEC"/>	
2.	Touch desired preheat temperature pad.	<input type="text" value="5"/> 325°F	
3.	Enter desired cooking time.	<input type="text" value="2"/> <input type="text" value="0"/> <input type="text" value="0"/> <input type="text" value="0"/>	
4.	Touch START pad. When the oven reaches the programmed temperature, the Convection Fan Symbol will stop flashing and begin rotating and an audible signal will sound 4 times, and the temperature will be displayed.*	<input type="text" value="START"/>	
5.	Open door. Place food in oven. Close door. Touch START pad.	<input type="text" value="START"/>	

* At this point the oven is preheated. If the oven door is not opened, the oven will begin temperature holding operation. The oven will automatically hold at the preheat temperature for 15 minutes. After this time has elapsed, an audible signal will sound and the oven will turn off. The time of day will reappear on the display.

To Preheat and Cook with Automatic Mix

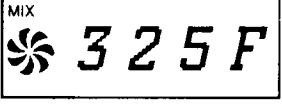

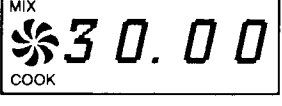











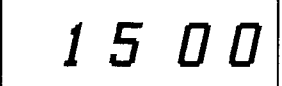





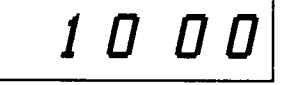

*Suppose you want to preheat the oven to 325°F and bake a pie for 20 minutes on HIGH MIX/ROAST. See "To Preheat and Cook with Convection" above. Touch HIGH MIX/ROAST pad after step 3. Continue with steps 4 and 5.

Step	Procedure	Pad Order	Display
4.	Touch HIGH MIX/ROAST pad. Note: If a different mix cooking temperature is desired, also touch temperature pad.		
5	Touch START pad. As with previous procedure, oven will sound when preheated. Open door. Place food in oven. Close door and touch START pad.		

To Sequence Cook with Automatic Mix

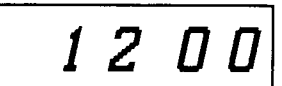
Your oven can be programmed for up to four sequences for cooking. First touch time and then cooking mode. If HIGH MIX or LOW MIX are a desired cooking mode, first touch time, then HIGH MIX or LOW MIX and then a temperature pad.

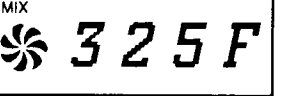
* Suppose you want to cook on Convection for 15 minutes at 400°F, followed by 10 minutes at MEDIUM microwave cooking level and then 12 minutes at HIGH MIX/ROAST.

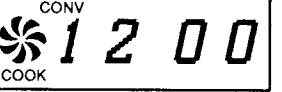
Step	Procedure	Pad Order	Display
1.	Enter the desired cooking time for the first sequence.	   	
2.	Enter first cooking mode. Touch CONVECTION pad.		
3.	Touch desired preheat temperature pad.	 400°F	
4.	Enter desired cooking time for the second sequence.	   	
5.	Enter desired variable cooking control setting. Touch MED for MEDIUM.		
6.	Enter desired cooking time for the third sequence.	   	
7.	Enter third cooking mode. Touch HIGH MIX/ROAST pad.		
8.	Touch START pad. The oven will automatically change to each sequence as programmed.		

Convection Cooking Using Temperature Probe

The Temperature Probe can be used also during convection cooking or automatic mix cooking to cook food to an internal temperature of 90°F to 200°F.

When the desired food temperature has been reached, the oven will turn off automatically.

*Suppose you want to cook a roast at 325°F (convection temperature) until it reaches 150°F (food temperature).

Step	Procedure	Pad Order	Display
1.	Place probe in meat. Insert probe plug into the receptacle in the top center of the oven cavity. Touch number pads for desired food temperature.	<div style="display: inline-block; border: 1px solid black; padding: 2px 5px;">1</div> <div style="display: inline-block; border: 1px solid black; padding: 2px 5px; margin-left: 10px;">5</div> <div style="display: inline-block; border: 1px solid black; padding: 2px 5px; margin-left: 10px;">0</div>	1 5 0
2.	Touch TEMP PROBE pad.	<div style="border: 1px solid black; padding: 5px; display: inline-block;">TEMP PROBE</div>	<div style="text-align: right; font-size: 0.8em;">TEMP</div> 1 5 0 F
3.	Touch CONVECTION pad.	<div style="border: 1px solid black; padding: 5px; display: inline-block;">CONVEC</div>	<div style="display: flex; justify-content: space-between; font-size: 0.8em;"> CONV TEMP </div> <div style="display: flex; align-items: center; justify-content: center;"> F </div>
4.	Touch convection temperature for desired oven temperature. (Ex. 325°F)	<div style="border: 1px solid black; padding: 5px; display: inline-block; text-align: center;"> 5 325°F </div>	<div style="display: flex; justify-content: space-between; font-size: 0.8em;"> CONV TEMP </div> <div style="display: flex; align-items: center; justify-content: center;"> 3 2 5 F </div>
5.	Touch START pad.	<div style="border: 1px solid black; padding: 5px; display: inline-block;">START</div>	<p style="font-size: 0.8em;">When food temperature is lower than 90°F:</p> <div style="display: flex; justify-content: space-between; font-size: 0.8em;"> CONV TEMP </div> <div style="display: flex; align-items: center; justify-content: center;"> L O F </div> <div style="text-align: left; font-size: 0.8em; margin-top: 5px;"> COOK </div>

When the internal temperature reaches 90°F, the readout will display the actual temperature to the food as it increases to 150°F.

Automatic Mix Cooking Using Temperature Probe





*Suppose you want to cook a roast on HIGH MIX/ROAST until it reaches 150°F.

See "Convection Cooking Using Temperature Probe" above. Touch HIGH MIX/ROAST instead of CONVECTION pad in Step 3, eliminate Step 4, and touch START.

Convection and Microwave Cooking

Your oven can be programmed to combine convection and microwave cooking operations.



*Suppose you want to bake chicken pieces at 350°F for 15 minutes and then cook at MEDIUM for 3 minutes.

Step	Procedure	Pad Order	Display
1.	Enter desired convection cooking time.	1 5 0 0	15 00
2.	Touch CONVECTION pad.	CONVEC	 CONV F
3.	Enter desired convection temperature.	6 350°F	 CONV 350 F
4.	Enter desired microwave cooking control setting.	3 0 0	3 00
5.	Select variable cooking control setting.	MED	3.00 MED
6.	Touch START pad.	START	 CONV COOK 15.00 The timer begins to count down to zero. When it reaches zero, the display changes:  CONV COOK 3.00 MED The timer counts down the microwave time to zero.

Broiling

Preheating is automatic when the BROIL setting is used. Only actual cooking time is entered; the oven signals when it is preheated to 450°F. Use broil for steaks, chops, chicken pieces and many other foods. See your KitchenAid Convection Cookbook for suggestions and cooking time.

*Suppose you want to broil a steak for 15 minutes.

Step	Procedure	Pad Order	Display
1.	Enter maximum broiling time.	<input type="text" value="1"/> <input type="text" value="5"/> <input type="text" value="0"/> <input type="text" value="0"/>	15 00
2.	Touch BROIL pad. No food in oven.	<input type="text" value="BROIL"/>	CONV  450 F
3.	Touch START pad. When oven temperature reaches 450°F, the Convection Fan Symbol will stop flashing and begin rotating. An audible signal will sound 4 times.*	<input type="text" value="START"/>	<input type="text" value="PRE-"/> and <input type="text" value="HEAT"/> will be displayed repeatedly. CONV  450 F COOK
4.	Open door. Place food in oven. Close door. Touch START pad.	<input type="text" value="START"/>	CONV  15.00 COOK





* Oven will maintain 450°F for 15 minutes after signal sounds and Convection Fan Symbol begins to rotate. If the door is not opened (food placed in oven) within 15 minutes, The oven will automatically cut off.

Although timer is set for the maximum broiling time as directed in Step 1, check food at minimum time recommended in the chart. This step will eliminate the need to completely reprogram the oven if additional time is needed. Simply close the oven door and touch START to continue.

Slow Cook

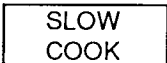
The SLOW COOK setting is preset for 300°F for 4 hours. It is designed for foods which cook longer than 99 minutes 99 seconds at 300°F or less. Foods such as baked beans or stews are best cooked slowly at low temperatures. The SLOW COOK feature expands the length of cooking time to a maximum of 4 hours at 300°F or lower. It adds to the overall versatility of your new Microwave Convection oven. When using this setting, no cooking time is entered; you will need to time the food manually.

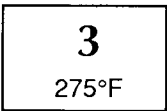
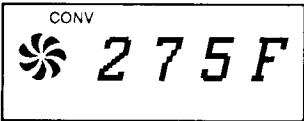
*Suppose you want to change oven temperature from 300°F to 275°F.

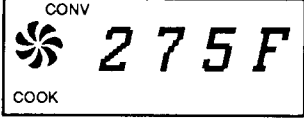
Step	Procedure	Pad Order	Display
1.	Touch SLOW COOK pad.		
2.	Enter desired oven temperature if you want to change from 300°F.		
3.	Touch START pad.		 Convection Fan Symbol will begin to rotate.

After 4 hours an audible signal will sound. All indicators will go out. The time of day will appear on the display. If the oven door is opened or the STOP/CANCEL pad is touched during the SLOW COOK cycle, the program will be cancelled and the oven will turn off. If you need to check food, open the oven door and check or stir. After closing the door, touch SLOW COOK, lower temperature if needed, and touch START to reactivate the oven. When changing SLOW COOK temperature, a temperature above 300°F cannot be entered.

Easy Minute

Easy Minute allows you to cook for a minute at HIGH by simply touching the Easy Minute pad. You can also extend cooking time in multiples of 1 minute by repeatedly touching the Easy Minute pad during the cooking program of microwave, convection or combination cooking.

* Suppose you want to heat a cup of soup for one minute.

Step	Procedure	Pad Order
1.	Easy Minute pad	EASY MINUTE

Note: 1. Easy Minute can only be entered within 1 minute after cooking, closing the door, touching STOP/ CANCEL pad or during cooking. Easy Minute cannot be used to start the oven if any program is on display.



2. The cooking time can be increased in multiples of 1 minute by repeatedly touching the Easy Minute pad during a cooking program of microwave, convection or combination cooking and during maintaining temperature with the probe. Easy Minute cannot be used with Reheat, Sensor Temp, Custom Defrost, Custom Cook and Slow Cook.

Custom Cook

Custom Cook will automatically compute the oven temperature, microwave power and cooking time for baking, roasting, and broiling. It is based on specific foods and the quantity or weight of the food.

To Cook With Custom Cook

*Suppose you want to use Custom Cook to cook a 6.95 pound chicken.

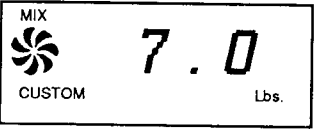
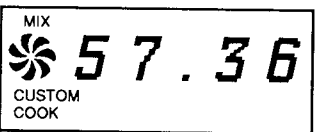
Step	Procedure	Pad Order	Display
1.	Touch CUSTOM COOK pad.	CUSTOM COOK	 CUSTOM FOOD
2.	Select food category for Custom Cook. Touch 3 to cook Roast Chicken.	3	 MIX CC.-3 Lbs. CUSTOM Lbs. will flash on and off.
3.	Touch number pads to enter weight.	7 0	 MIX 7.0 Lbs. CUSTOM Lbs. stops flashing.
4.	Touch the START pad.	START	 MIX 57.36 CUSTOM COOK Convection fan symbol will rotate.

After cooking, **COVER** and **STAND** will be displayed repeatedly.

Open oven door or touch STOP/CANCEL pad. The time of day will reappear on the display.

If the cooking time for any Custom Cook food is more than one hour, 1H and the minutes will appear on the display. When the countdown reaches one hour (60 minutes), minutes and seconds will appear on the display and continue to count down.

- NOTE:
1. Use foods listed in the Custom Cook Section of the control panel.
 2. Custom Cook works with foods at normal storage temperature. For example, chicken would be at refrigerator temperature and cakes and bread would be at room temperature.
 3. Foods weighing more or less than the quantity listed in the chart should be cooked following guidelines in the cookbook. If you enter an incorrect quantity and touch the START pad, **ERROR** and the incorrect quantity will appear alternately on the display.
 4. The weight or quantity can be entered for each Custom Cook Setting. The unit, pounds (Lbs.) or quantity (No.), will appear on the display. For example, turkey would be calculated in pounds and hamburger patties would be quantity.
 5. Pounds must be rounded off to the nearest tenth of a pound (Example: 5.45 lbs. should be rounded off to 5.5 lbs.)
 6. Preheat is automatic with CC-1 (Hamburgers, broiled) and CC-2 (chicken, broiled). When the oven reaches the desired temperature, an audible signal will sound 4 times; place the food in the oven and touch START.
 7. All foods can be seasoned, as desired, before cooking begins.
 8. If the door is opened during Custom Cook, shut door and touch START pad to resume cooking.

Custom Cook Chart

Food	Custom Cook Setting	Amount	Unit	Procedure	Comments
Hamburgers, broiled	1	2-8 pieces	Number of patties	Season, as desired. Place on broiling trivet.	Patties should be 1/4 lb. each, 1/2-inch thick.
Chicken, broiled	2	0.5 - 3.5 lbs.	Pounds	Season, as desired. Place on broiling trivet.	Chicken next to bone should no longer be pink.
Chicken, roast	3	2.5 - 7.5 lbs.	Pounds	Season, as desired. Place on broiling trivet.	Let stand, covered with foil, 10 to 15 minutes.
Turkey	4	6.5 - 9.0 lbs.	Pounds	Season, as desired. If stuffed, add 1-2 lbs. for stuffing depending on size of bird. Place on broiling trivet.	Let stand, covered with foil, 10 - 15 minutes.
Cake layers	5	1 - 2 layers	Number of layers	One or two 9-inch round metal cake pans, greased.	Cool 10 minutes in pan on wire rack; remove from pan. Complete cooling on wire rack.
Bread loaves	6	1 - 2 loaves	Number of loaves	One or two 9 x 5 metal loaf pans, greased.	Remove from pans immediately. Cool on wire racks.

⚠ WARNING

To avoid sickness and food waste when using AUTO START:

- Do not use foods that will spoil while waiting for cooking to start, such as dishes with milk or eggs, cream soups, and cooked meats or fish. Any food that has to wait for cooking to start should be very cold or frozen before it is put in the oven. **MOST UNFROZEN FOODS SHOULD NEVER STAND MORE THAN TWO HOURS BEFORE COOKING STARTS.**
- Do not use foods containing baking powder or yeast when using AUTO START. They will not rise properly.
- Do not allow food to remain in oven for more than two hours after end of cooking cycle.

If you wish to program your oven to begin cooking automatically at a designated time of day, follow this procedure:

*Suppose you want to start cooking a stew for 20 minutes on MEDIUM at 4:30 this afternoon.

Before setting, check to make sure the clock is showing the correct time of day.

Auto Start

Step	Procedure	Pad Order
1.	Enter the desired start time.	<div style="display: flex; justify-content: space-around; width: 100px;"> <div style="border: 1px solid black; padding: 2px 5px;">4</div> <div style="border: 1px solid black; padding: 2px 5px;">3</div> <div style="border: 1px solid black; padding: 2px 5px;">0</div> </div>
2.	Touch CLOCK/AUTO START pad.	<div style="border: 1px solid black; padding: 5px; width: 100px; margin: 0 auto;"> CLOCK <hr style="border: 0; border-top: 1px solid black;"/> AUTO START </div>
3.	Enter desired cooking program.	<div style="display: flex; justify-content: space-around; width: 100px; margin-bottom: 5px;"> <div style="border: 1px solid black; padding: 2px 5px;">2</div> <div style="border: 1px solid black; padding: 2px 5px;">0</div> <div style="border: 1px solid black; padding: 2px 5px;">0</div> <div style="border: 1px solid black; padding: 2px 5px;">0</div> </div> <div style="border: 1px solid black; padding: 5px; width: 100px; margin: 0 auto; text-align: center;">MED</div>
4.	Touch START pad.	<div style="border: 1px solid black; padding: 10px; width: 100px; margin: 0 auto; text-align: center;">START</div>

NOTE: The Auto Start feature can be used for any of the programs except Custom Defrost and Easy Minute. Once you have correctly programmed the oven for Auto Start, the correct time of day (not the Auto Start time) will appear on the display. To check the programmed Auto Start time, Touch the CLOCK/AUTOSTART pad. The programmed Auto Start time will appear as long as your finger is touching the pad. Checking the Auto Start Time will not interfere with the operation of oven. To cancel Auto Start, simply touch the STOP/CANCEL pad twice.

SAFETY PRECAUTIONS

⚠️ WARNING

To reduce the risk of fire, electrical shock, injury to persons, or damage when using the microwave oven, follow these precautions.

1. Do not operate the oven empty in the microwave mode. Either food or water should always be in the oven during operation to absorb microwave energy.
2. Limit use of metal to those specific examples given in the utensil section of your cookbook. Generally, metal should not be used during operations of microwave mode only. Metal utensils can be used for convection and combination cooking.
Aluminum foil can be used for shielding to prevent overcooking or overdefrosting. Pieces should be small and smooth. Never allow to touch oven wall or door.
3. Do not cook eggs in the shell. Pressure will build up inside the shell and may cause them to burst and burn you. Do not reheat cooked eggs unless they are scrambled or chopped. Puncture the egg yoke before cooking eggs.
4. Avoid canning in the microwave oven; harmful bacteria may not be destroyed. Closed glass jars may explode resulting in damage to the oven or personal injury.
5. Do not heat oil or fat for deep frying. Microwaveable utensils are not suitable and it is difficult to maintain appropriate deep frying temperatures.
6. Pierce the "skin" of potatoes, whole squash, apples, or any fruit or vegetable with a skin covering before cooking. Do not overcook. Fire could result.
7. Popcorn may be cooked in a special microwave popcorn popper. Follow popper manufacturer's instructions carefully. Microwave popped corn produces a lower yield than conventional popping; there will be a number of unpopped kernels. Do not use oil unless specified by the manufacturer.
Popcorn bagged especially for the microwave oven can also be used. Follow package directions carefully and never exceed the suggested times, usually five minutes. **Elevate bag on an inverted glass pie plate.** When popping slows to one or two seconds between pops, remove from the oven. Do not try to re-pop unpopped kernels.
Never use a regular paper bag or glass utensil for popping corn. Overcooking may result in smoke and fire.
8. Do not use paper towels, plates, or other utensils made from recycled paper for microwave cooking. Recycled paper products may contain impurities which could cause the paper to ignite during microwave cooking.
9. Do not use plastic or styrofoam utensils for microwave cooking if the oven is hot from convection cooking. The utensils may melt.
10. Unlike microwave-only ovens, all microwave convection ovens have the tendency to become hot on the cabinet and oven door, as do conventional ovens and convection-only ovens. Be careful when touching parts other than the control panel during or immediately following convection cooking.
11. To test a dish for safe microwave oven use, put it into the oven with a cup of water **beside it**. Cook on HIGH Cook Power for one minute. **If the dish gets hot and water stays cool, do not use it.**
12. Liquids heated in certain containers (especially cylindrical-shaped containers) may become overheated. The liquid may splash out with a loud noise during or after heating or when adding ingredients (coffee, etc.) resulting in harm to the oven and possible personal injury. For best results stir any liquid several times before heating or reheating.
13. **DO NOT** use the oven to sterilize objects (baby bottles, etc.). It is difficult to maintain the high temperature required for safe sterilization.
14. **DO NOT** heat, store or use flammable, inflammable or corrosive materials in or near the oven. Fumes can create a fire hazard or explosion.
15. **NEVER** lean on the door or allow a child to swing on it when the door is open. Injury could result.
16. **DO NOT** try to melt paraffin wax in the oven. You may be burned.
17. **DO NOT** use newspaper or other printed paper in the oven. Fire could result.
18. **DO NOT** dry flowers, fruit, herbs, wood, paper, gourds or clothes in the oven. Fire could result.
19. **DO NOT** use the oven for storage. Do not leave paper products, books or cooking utensils in the oven when not in use. Fire may result if someone accidentally starts the oven. Don't let anything touch the top of the oven.

CONDENSATION

Occasionally some foods will cause the oven to "sweat." The humidity and moisture in food will influence the amount of moisture in the oven. Generally, covered foods will not cause as much condensation as uncovered foods. Be sure the vents are not blocked.

Condensation is a normal part of microwave cooking.

The door seal is designed to prevent leakage of microwave energy during cooking. The door seal does not need to be airtight in order to accomplish this. Occasionally moisture may appear around the oven door. You may be able to see some small areas of light or feel air movement around the oven door. None of these situations are abnormal or necessarily indicate the oven is leaking microwave energy.

CLEANING AND CARE

Exterior

The outside surface is precoated metal and plastic. Clean the outside with mild soap and water; rinse and dry with a soft cloth. Do not use any type of household or abrasive cleaner.

Interior

The oven walls, ceiling, and floor are stainless steel. For easy cleaning, wipe up any splatters or spills with a soft, damp cloth or sponge after each use or clean with mild detergent and water.

For heavier soil, use a mild cleaner such as Soft Scrub® or Bon Ami® following manufacturer's instructions.

Commercial oven cleaner, preferably the brush-on-type can be used following manufacturer's instructions.

Apply to stainless walls, floor, ceiling or turntable only. Do not use spray-on oven cleaner, it may damage

internal parts. Plastic or nylon scouring sponges or pads recommended for use on Teflon* and Silverstone*

can be used on the oven walls, ceiling or turntable. Be sure to rinse cavity with a damp cloth or sponge

after cleaning to remove completely all cleaner residue. Dry with a soft cloth.

Do not use harsh abrasives.

*Dupont's registered trademark.

⚠ WARNING

Fire Hazard

Grease or soil accumulation may cause a fire hazard or longer cooking times. Clean oven to prevent fire hazard.

Turtable/Turtable Support:

The turntable and turntable support can be removed for easy cleaning. Wash the turntable and turntable support in mild sudsy water; for stubborn stains, use a mild cleanser and scouring sponge as described above. The turntable and turntable support are dishwasher-proof.

Foods with high acidity, such as tomatoes and lemons, will cause the porcelain enamel turntable to discolor. Do not cook highly acidic foods directly on the turntable; if spills occur, wipe up immediately.

The turntable motor shaft is not sealed, so excess water or spills should not be allowed to stand in this area.

Door:

Wipe the window on both sides with a damp cloth to remove any spills or splatters. Metal parts will be easier to maintain if wiped frequently with a damp cloth. Avoid the use of harsh abrasives.

Touch Control Panel:

Care should be taken in cleaning the touch control panel. If the control panel becomes soiled, open the oven door before cleaning. This will inactivate the control panel. Wipe the panel with a cloth dampened slightly with water only and dry with a soft cloth. Do not scrub or use any sort of chemical cleansers.

⚠ WARNING

Electrical Shock Hazard

Before replacing grease and charcoal filters, and oven and hood lamps, disconnect power to the oven at the circuit breaker panel or by unplugging. Failure to do so could result in electrical shock.

Grease Filters:

Filters should be cleaned at least once a month. Never operate your hood without the filters in place.

1. To replace grease filters, disconnect power to the oven at the circuit breaker panel or by unplugging.
2. Pull the tab toward the front of the oven, down slightly and remove the filter. Repeat for other filter.
3. Soak the filters in a sink or dish pan filled with hot water and detergent.
DO NOT use ammonia or other alkali; they will react with the filter material and darken it.
4. Agitate and scrub with a brush to remove embedded dirt.
5. Rinse thoroughly and shake dry.
6. Replace by fitting the filter back into the opening. Push back and up into place.
7. Reconnect electricity.

Hood Lamps:

1. To replace hood lamps, first disconnect power to the oven at the circuit breaker panel or by unplugging.
2. Push the cover by hand and slide it toward the back, and open the front side. (See illustration.)
3. Replace only with equivalent 40 watt bulb available at most hardware stores or lighting centers. **DO NOT USE A BULB LARGER THAN 40 WATTS.**

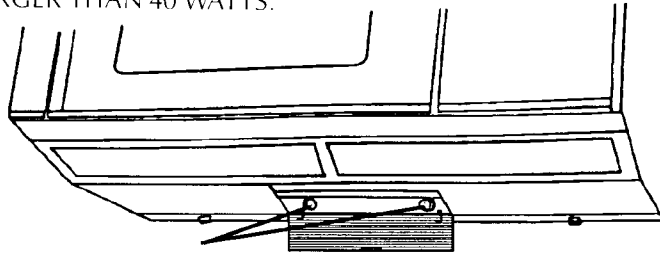

4. Slide cover back into place. The glass covering the lamps may become hot. Do not touch the glass while hood lamps are in use. Do not use hood lamps for long term use.
5. Reconnect electricity.

⚠ WARNING

Fire Hazard

Use a 40-watt maximum bulb. Failure to do so could result in fire.

Charcoal Filter

The supplied charcoal filter is used for non-vented, recirculated installation. Install according to instructions packed with filter. The filter should be changed every 6 to 12 months depending on use.

1. Disconnect power to the oven at the circuit breaker panel or by unplugging. (See illustration below).
2. Remove louver mounting screw from top center location on top of cabinet.
3. Push DOWN at two (2) positions (A) and UP at position (B) to unhook louver from unit and remove.
4. Change the charcoal filter.
5. Snap louver back in place and replace the screw.
6. Reconnect electricity.

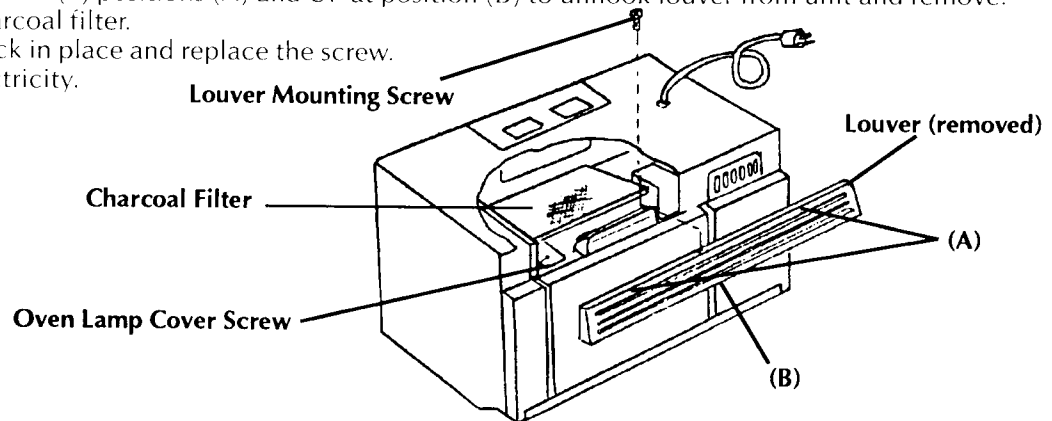

Oven Lamp:

Remove the louver per instructions 1-3 above and charcoal filter, if used.

4. Remove and save one Phillips head screw from oven lamp cover.
5. Remove old lamp and replace only with equivalent 30 watt lamp available from most hardware stores and lighting centers. **DO NOT USE BULB LARGER THAN 30 WATTS.**
6. Replace the oven lamp cover, Phillips head screw and charcoal filter (if used); snap louver back into place and replace louver mounting screw.
7. Reconnect electricity.

⚠ WARNING

Fire Hazard

Use a 30-Watt maximum bulb. Failure to do so could result in fire.

Hood:

The hood fan will automatically start when heat rises from range surface units. This protects the oven from excessive temperature rise. Fan will stay on until temperature decreases. Fan starts automatically at low speed. You can select either HIGH or LOW speeds. Fan cannot be manually turned off during this time.

PRECAUTIONS FOR PROPER USE:

1. **DO NOT** leave range unattended while using high temperatures. Automatic fan may start and provide excessive air to the surface units. This may cause spattering or boil-over.
2. Avoid burning food.
3. Keep grease filters clean.

SERVICE CALL CHECK

Please check the following before calling service:

1. Does the display light? Yes _____ No _____
2. When the door is opened, does the oven lamp light? Yes _____ No _____

If "No" is the answer for both, please check the wall socket and breaker. If both the wall socket and breaker are functioning properly, CONTACT YOUR NEAREST AUTHORIZED KITCHENAID SERVICER.

Please check the following if "Yes" is the answer to either of the above questions:

3. Place one cup of water in a glass measuring cup in the oven and close the door securely. Oven light should go off if the door is closed properly.

Program the oven for three minutes on HIGH, Touch these pads:

3	0	0
START		

- A. Does the oven lamp light? Yes _____ No _____
- B. Does the cooling fan work?
(Put your hand over the top ventilation openings.) Yes _____ No _____
- C. Does the turntable rotate? It is normal for the turntable to turn in either direction. Yes _____ No _____
- D. Do COOK and HIGH indicators light? Yes _____ No _____
- E. At the end of 3 minutes, is the water bubbling? Yes _____ No _____
4. Remove the water from the oven and program:

5	0	0
CONVEC		
450°F		
START		

- A. Do CONV, Fan Symbol, and COOK light? Yes _____ No _____
- B. After the oven shuts off, is the inside of the oven hot? Yes _____ No _____

If "NO" is the answer to any of the above questions, PLEASE CONTACT YOUR NEAREST AUTHORIZED KITCHENAID SERVICER.

KITCHENAID®

ELECTRIC BUILT-IN MICROWAVE/HOOD AND MICROWAVE-CONVECTION/HOOD WARRANTY

LENGTH OF WARRANTY:	KITCHENAID WILL PAY FOR:	KITCHENAID WILL NOT PAY FOR:
ONE YEAR FULL WARRANTY FROM DATE OF INSTALLATION	Replacement parts and repair labor costs to correct defects in materials or workmanship. Service must be provided by an authorized KitchenAid servicing outlet.	A. Service calls to: <ol style="list-style-type: none"> 1. Correct the installation of the oven. 2. Instruct you how to use the oven. 3. Replace house fuses or correct house wiring.
SECOND THROUGH FIFTH YEAR LIMITED WARRANTY FROM DATE OF INSTALLATION	Replacement magnetron tube on microwave oven to correct defects in materials or workmanship. For model KHMC106, replacement part for the electric element to correct defects in material and workmanship.	B. Repairs when oven is used in other than normal home use. C. Damage resulting from accident, alteration, misuse, abuse, improper installation or installation not in accordance with local electrical codes. D. Any labor costs during the limited warranties. E. Replacement parts or repair labor costs for units operated outside the United States. F. Pick up and delivery. This product is designed to be repaired in the home.

KITCHENAID, INC. DOES NOT ASSUME ANY RESPONSIBILITY FOR INCIDENTAL OR CONSEQUENTIAL DAMAGES.

Some states do not allow the exclusion or limitation of incidental or consequential damages, so this exclusion or limitation may not apply to you. This warranty gives you specific rights and you may have other rights which vary from state to state.

HOW TO ARRANGE FOR SERVICE

- * First call your dealer or repair service he recommends.
- * All service should be handled locally by the dealer from whom you purchased the unit or an authorized KitchenAid servicing outlet. If your local service is not satisfactory, contact the Customer Relations Department, KitchenAid, Inc., P.O. Box 558, St. Joseph, Michigan 49085-0558. Call toll-free 800-422-1230.

© 1989 KITCHENAID, INC.

St. Joseph, Michigan USA 49085

Part No. TINSEA472WRRO/4174868