











Use & Care Manual

Electric Range

Welcome	2	
Important Safety Instructions ..	3-4	
Installation Instructions.....	5-6	
Setting Surface Controls....	6-9	
Surface Cooking	10	
Before Setting Oven Controls	10-11	
Setting Oven Controls	11	
Cooking Informations	12-13	
Care & Cleaning	14-20	
Adjusting Your Oven Temperature	20	
Before You Call Solutions to Common Problems	21-22	



Welcome & Congratulations

Please attach sales receipt here for future reference.

Congratulations on your purchase of a new appliance! We are very proud of our product and are completely committed to providing you with the best service possible. Your satisfaction is our number one priority.

We know you'll enjoy your new appliance and **Thank You** for choosing our product. We hope you consider us for future purchases.

PLEASE CAREFULLY READ AND SAVE THESE INSTRUCTIONS

This Use & Care Manual contains general operating instructions for your appliance and feature information for several models. Your product **may not** have all the described features. The graphics shown are representative. The graphics on your appliance may not look exactly like those shown. These instructions are not meant to cover every possible condition and situation that may occur. Common sense and caution must be practiced when installing, operating and maintaining any appliance.

Please record your model and serial numbers below for future reference.

Model Number: _____

Serial Number: _____

Purchase Date: _____

Serial Plate Location

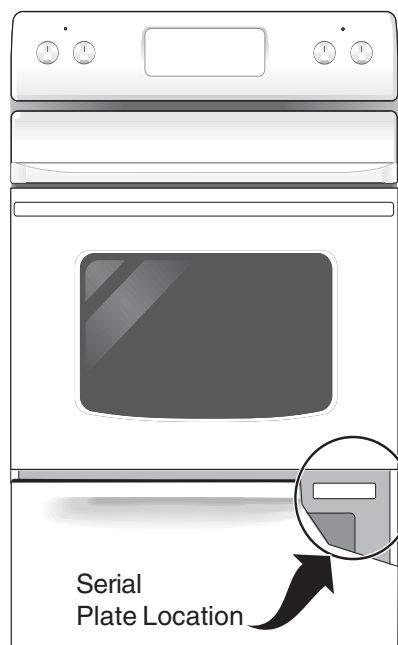

Important Safety Instructions



Read all instructions before using this appliance.

Save these instructions for future reference.

This guide contains important safety symbols and instructions. Please pay special attention to these symbols and follow all instructions given. Here is a brief explanation of these symbols.

⚠ WARNING This symbol will help alert you to situations that may cause serious bodily harm, death or property damage.

⚠ CAUTION This symbol will help alert you to situations that may cause bodily injury or property damage.

- **Remove all tape and packaging wrap before using the range. Destroy the carton and plastic bags after unpacking the range.** Never allow children to play with packaging material.
 - **Proper Installation—Be sure your appliance is properly installed and grounded by a qualified technician in accordance with CSA C22.1 PART 1 — latest edition and local code requirements.** Install only per installation instructions provided in the literature package for this range.
 - Ask your dealer to recommend a qualified technician and an authorized repair service. Know how to disconnect the electrical power to the range at the circuit breaker or fuse box in case of an emergency.
 - **User Servicing — Do not repair or replace any part of the appliance unless specifically recommended in the manuals.** All other servicing should be done only by a qualified technician to reduce the risk of personal injury and damage to the range.
 - **Never modify or alter the construction of a range by removing panels, wire covers or any other part of the product.**
- ⚠ WARNING** Stepping, leaning or sitting on the door or drawer of this range can result in serious injuries and may also cause damage to the range. Do not allow children to climb or play around the range. The weight of a child on an open door may cause the range to tip, resulting in serious burns or other injury.
- ⚠ WARNING** Do not use the oven or warmer drawer (if equipped) for storage.
- **Storage in or on Appliance — Flammable materials should not be stored in an oven, near surface units or in the storage drawer.** This includes paper, plastic and cloth items, such as cookbooks, plasticware and towels, as well as flammable liquids. Do not store explosives, such as aerosol cans, on or near the range. Flammable materials may explode and result in fire or property damage.
- ⚠ CAUTION** Do not store items of interest to children in the cabinets above a range or on the backguard of a range. Children climbing on the range to reach items could be seriously injured.
- **Do not leave children alone. Children should not be left alone or unattended in the area where an appliance is in use.** They should never be allowed to sit or stand on any part of the appliance.
 - **DO NOT TOUCH SURFACE UNITS, AREAS NEAR THESE UNITS, OVEN HEATING ELEMENTS OR INTERIOR SURFACES OF THE OVEN OR WARMER DRAWER (if equipped).** Both surface units and oven heating elements may be hot even though they are dark in color. Areas near surface units may become hot enough to cause burns. During and after use, do not touch, or let clothing or other flammable materials touch these areas until they have had sufficient time to cool. Among these areas are the cooktop, surfaces facing the cooktop, the oven vent openings and surfaces near these openings, oven door and window.
 - **Wear Proper Apparel — Loose-fitting or hanging garments should never be worn while using the appliance.** Do not let clothing or other flammable materials contact hot surfaces.
- ⚠ WARNING** Never use your appliance for warming or heating the room.
- **Do Not Use Water or Flour on Grease Fires—Smother the fire with a pan lid, or use baking soda, a dry chemical or foam-type extinguisher.**
 - **When heating fat or grease, watch it closely.** Fat or grease may catch fire if allowed to become too hot.
 - **Use Only Dry Potholders — Moist or damp potholders on hot surfaces may result in burns from steam.** Do not let the potholders touch hot heating surface units or interior oven elements. Do not use a towel or other bulky cloth instead of a potholder.
 - **Do Not Heat Unopened Food Containers—Build-up of pressure may cause the container to burst and result in injury.**
 - **Remove the oven door from any unused range if it is to be stored or discarded.**
 - **IMPORTANT—Do not attempt to operate the oven during a power failure. If the power fails, always turn the oven off.** If the oven is not turned off and the power resumes, the oven will begin to operate again. Food left unattended could catch fire or spoil.
- ⚠ CAUTION** Electronic controllers can be damaged by cold temperatures. When you use your range for the first time, or if it has not been used for a long period of time, make sure that it has been exposed to a temperature above 0°C/32°F for at least 3 hours before connecting it to the power supply.



Important Safety Instructions

IMPORTANT INSTRUCTIONS FOR USING YOUR COOKTOP

- **Know which knob controls each surface heating unit.**
- **Use Proper Pan Size** — This appliance is equipped with one or more surface units of different sizes. Select utensils having flat bottoms large enough to cover the surface unit. The use of undersized utensils will expose a portion of the surface heating unit to direct contact and may result in ignition of clothing. Proper relationship of utensil to the surface unit will also improve efficiency.
- **Utensil Handles Should Be Turned Inward and Should Not Extend Over Adjacent Surface Units** — To reduce the risk of burns, ignition of flammable materials, and spillage due to unintentional contact with the utensil.
- **Never Leave Surface Units Unattended** — Boilovers cause smoking and greasy spillovers that may ignite, or a pan that has boiled dry may melt.
- **Do Not Immerse or Soak Removable Heating Elements** — Heating elements should never be immersed in water. Heating elements clean themselves during normal operation.
- **Glazed Cooking Utensils** — Only certain types of glass, glass/ceramic, ceramic, earthenware, or other glazed utensils are suitable for rangetop service without breaking due to the sudden change in temperature. Check the manufacturer's recommendations for rangetop use.

FOR CERAMIC GLASS COOK TOP MODELS

- **Do Not Clean or Operate a Broken Cooktop** — If cooktop should break, cleaning solutions and spillovers may penetrate the broken cooktop and create a risk of electric shock. Contact a qualified technician immediately.
- **Clean Cooktop with Caution** — If a wet sponge or cloth is used to wipe spills on a hot cooking area, be careful to avoid a steam burn. Some cleaners can produce harmful fumes if applied to a hot surface.
- **Avoid scratching the cooktop glass with sharp objects.**

IMPORTANT INSTRUCTIONS FOR USING YOUR OVEN

- **Use Care When Opening Door** — Stand to the side of the range when opening the door of a hot oven. Let hot air or steam escape before you remove or replace food in the oven.
- **Keep Oven Vent Ducts Unobstructed.** The oven is vented between the cooktop and the backguard. Touching the surfaces in this area when the oven is operating may cause severe burns. Also, do not place plastic or heat-sensitive items on or near the oven vent. These items could melt or ignite.

- **Placement of Oven Racks.** Always place oven racks in desired location while oven is cool. Remove all utensils from the rack before removing rack. If rack must be moved while oven is hot, use extreme caution. Use potholders and grasp the rack with both hands to reposition. Do not let potholders contact the hot oven element or interior of the oven.
- **Do not use a broiler pan without its insert.** The broiler pan and grid allow dripping fat to drain and be kept away from the high heat of the broiler.
- **Do not cover the broiler grid with aluminum foil.** Exposed fat and grease could ignite.
- **Do not touch a hot light bulb with a damp cloth.** Doing so could cause the bulb to break. Disconnect the range or turn off the power to the range before removing and replacing light bulb.
- **Protective Liners** — Do not use aluminum foil to line oven bottom or any other part of the range. Only use aluminum foil as recommended for baking if used as a cover placed on the food. Any other use of protective liners or aluminum foil may result in a risk of electric shock or fire or a short circuit.

SELF-CLEANING OVENS

- **Clean in the self-cleaning cycle only the parts of the oven listed in this owner's guide.** Before self-cleaning the oven, remove all utensils stored in the oven.
- **Do not clean the oven door gasket.** Care should be taken not to rub, damage or move the gasket.
- **Do not use oven cleaners.** No oven cleaner or oven liner protective coating of any kind should be used in or around any part of the oven.
- **Remove oven racks.** Oven racks colour will change if left in the oven during a self-cleaning cycle.

CAUTION The health of some birds is extremely sensitive to the fumes given off during the self-clean cycle of any range. Move birds to another well ventilated room.

IMPORTANT INSTRUCTIONS FOR CLEANING YOUR RANGE

- **Clean the range regularly to keep all parts free of grease that could catch fire.** Exhaust fan ventilation hoods and grease filters should be kept clean. Do not allow grease to accumulate. Greasy deposits in the fan could catch fire. Refer to the hood manufacturer's instructions for cleaning.

Installation Instructions

Installation and service must be performed by a qualified technician.



IMPORTANT: Save for the local electrical inspector's use.
Read and save these instructions for future reference.

Clearances and Dimensions

- Provide adequate clearances between the range and adjacent combustible surface (1.3cm (1/2")) to the cabinet side walls and the rear wall).
- Location—Check location where the range will be installed. Check for proper electrical supply and the stability of floor.
- Dimensions that are shown must be used. Given dimensions provide minimum clearance. Contact surface must be solid and level.

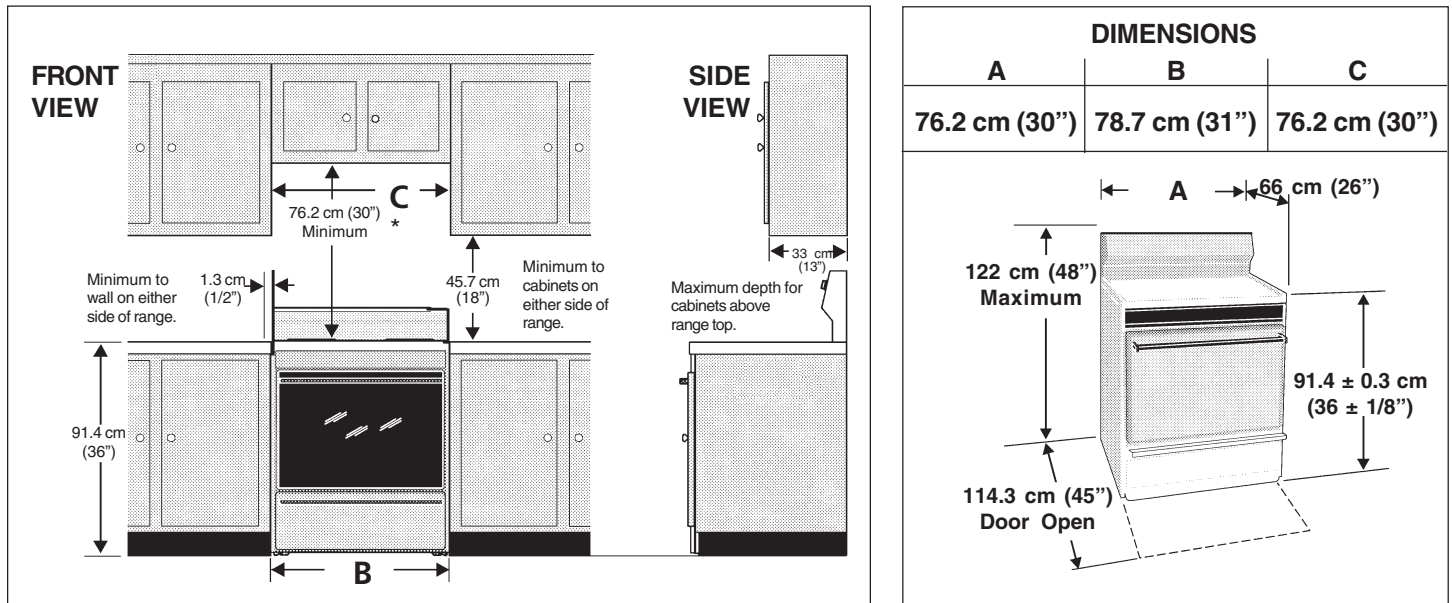

* 76.2 cm (30") Minimum clearance between the top of the cooking surface and the bottom of an unprotected wood or metal cabinet; or 61 cm (24") Minimum when bottom of wood or metal cabinet is protected by not less than 0.64 cm (1/4") flame retardant millboard covered with not less than 0.038 cm (0.015") stainless steel, 0.061 cm (0.024") aluminum or 0.051 cm (0.020") copper. 1.3 cm (1/2") clearance is the minimum for the rear and sides of the range. Follow all dimension requirements provided above to prevent property damage, Potential fire hazard, and incorrect countertop and cabinet cuts.

To eliminate the risk of burns or fire by reaching over heated surface units, cabinet storage space located above the surface units should be avoided. If cabinet storage is to be provided, the risk can be reduced by installing a range hood that projects horizontally a minimum of 12.7 cm (5") beyond the bottom of the cabinets.

Electrical Connection Requirements

Plug the range cable (4 conductors) into a 4 conductor range outlet. Outlet must be properly grounded and in accordance with the Canadian Electrical Code (CSA Standard (C22.1 Part 1 -- latest edition) -- and any local electrical code requirements.

Location

Set your new range 1.3 cm (1/2") away from the rear wall and line it up with the kitchen counters. Make sure there is at least 1.3 cm (1/2") of clearance between each side of the range and the kitchen counters. Allow 7.6 cm (3") min. clearance between your range and the refrigerator, if they are side by side.

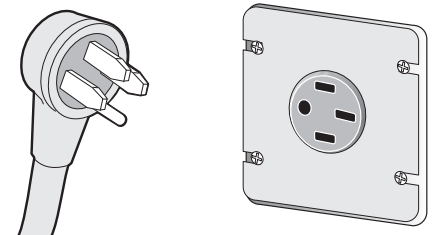

Circuit Protection (Models with electric outlet(s))

As a protection against surcharge, a 15 amp, 120 volt breaker is provided for each of the electric outlet(s) (2 max.) located on top or underneath of the control panel. Models with no electric outlet have no breaker.



Installation Instructions

Leveling

For good baking results, your range should be level. Screw type leveling legs are provided at each corner of the range at the base. Remove the storage drawer to adjust the leveling legs. (Refer to Storage Drawer section).

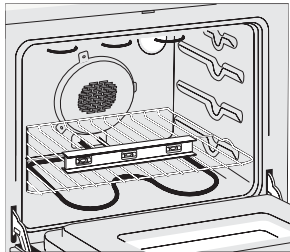

To level the range:

1. Use a 1-1/4" open end key or an adjustable wrench to equally unscrew the four leveling legs two to three turns each.
2. Install an oven rack in the center of the oven.
3. Move the range to its final position, then put a spirit level on the rack to check for levelness. Take two readings, one with the level placed diagonally first in one direction, and then the other.
4. Use the 1-1/4" key or wrench to adjust the leveling legs. Turn each one

until the range stands firm without wobbling.

5. Some models are supported by smooth glide rollers to facilitate moving.

If floor is flat and level, open the drawer and lower the front roller locking levers (some models) to prevent the range from moving.

If floor is not flat or level or if this model has rollers without locking levers, use the 4 leveling legs to level, support and prevent the range from moving.

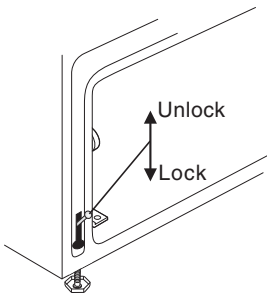
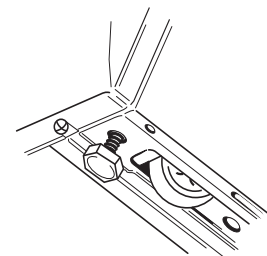

LOCKING THE FRONT ROLLERS (some models)



Setting Surface Controls

Models with Coil Elements (some models)

NOTE: All knobs shown in this owner's Guide are typical only.

1. Place the pan on the surface element.
2. Push in and turn the surface element control knob to desired setting.
3. The Element On indicator lights are located on the control panel between two element control knobs, one on each side, and will glow when a surface element is turned ON. A quick glance at this indicator light after cooking is an easy check to be sure ALL surface controls are turned OFF. Always turn the element off before removing the pan.

Note: The size and type of utensil used, and the amount and type of food being cooked will influence the setting needed for best cooking results.

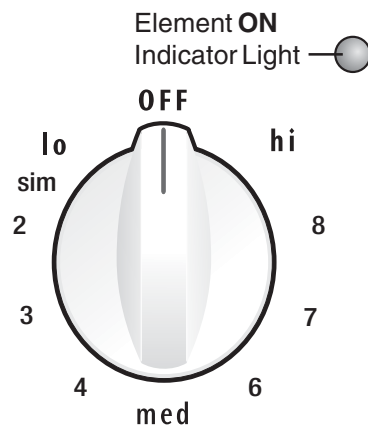

Setting	Type of Cooking
HI (MAX)	Start most foods, bring water to a boil, pan broiling.
5 (MED)	Maintain a slow boil, thicken sauces and gravies, steam vegetables.
2-4 (MED-LOW)	Keep food cooking, poach, stew.
LO (MIN)	Keep warm, melt, simmer.

The suggested settings found in the chart above are based on cooking in medium thickness aluminum pans with lids. Settings may vary when using other types of pans.

CAUTION Do not place items such as salt and pepper shakers, spoon holders or plastic wrappings on top of the cooktop when it is in use. These items could melt or ignite. Potholders, towels or wood could catch fire if placed too close to the element.

WARNING DO NOT use the surface element in self-clean mode. During the self-clean cycle, the surface elements, when used, are subjected to high heat. To ensure maximum element life, do not use the surface element during a self-clean cycle.

Setting Surface Controls



Models with Ceramic Glass Cooktop (Some models)

About the Ceramic Glass Cooktop

The ceramic cooktop has radiant surface elements located below the surface of the glass. The design of the ceramic cooktop outlines the area of the surface element underneath. **Make sure** the diameter of the pan matches the diameter of the element outline on the cooktop (See Figure 1).

Heat is transferred up through the surface of the cooktop to the cookware. Only flat-bottom cookware should be used. The type and size of cookware, the number of surface elements in use and their settings, are all factors that will affect the amount of heat that will spread to areas beyond the surface elements. The areas surrounding the elements may become **hot enough to cause burns**. The cooktop should not be used as a cutting board or work surface. Dropping heavy or hard objects on the cooktop may crack it. Pans with rough bottoms may scratch the cooktop surface. Placing foods directly on the smoothtop surface (without cooking utensils) is not recommended as difficult cleaning will result and foods may smoke and cause a potential fire hazard.

About the Radiant Surface Elements

The element temperature rises gradually and evenly. As the temperature rises, the element will glow red. To maintain the selected setting, the element will cycle on and off. The heating element retains enough heat to provide a uniform and consistent heat during the off cycle. For efficient cooking, turn off the element several minutes before cooking is complete. This will allow residual heat to complete the cooking process.

Locations of the Radiant Surface Elements and Controls

Your appliance is equipped with radiant surface elements with different wattage ratings. The ability to heat food quicker and in larger volumes increases as the element wattage increases.

The example shown (figure 1) describes a model with all kind of elements you could possibly have, **but the element configuration, the appearance and graphics of your cooktop may be different**.

NOTE: Due to the high intensity of heat generated by the surface elements, the glass surface will turn green when the element will be turned off. This phenomenon is normal and the glass will come back to its original white color after it has completely cooled down (White glass cooktops only).

Element Configuration, appearance and graphics of cooktops may be different

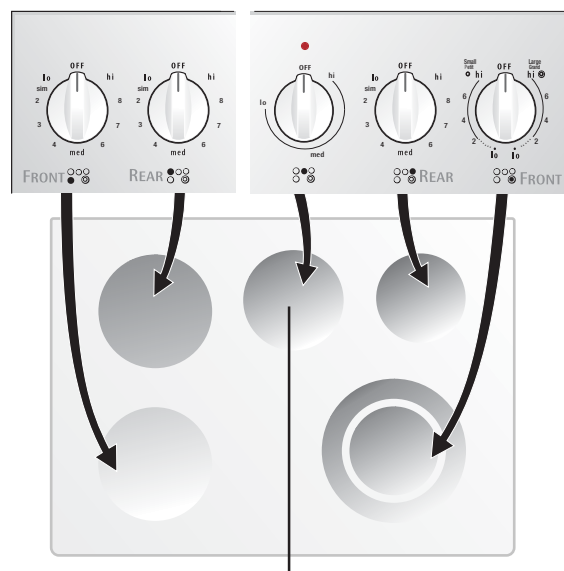

Warmer Zone Element (some models) - Figure 1

NOTE: Please read detailed instructions for ceramic glass cooktop cleaning in the **General Care & Cleaning** section and **Before You Call** checklist section of this Use and Care Guide.

NOTE: Radiant elements have a limiter that allows the element to cycle on and off, even at the HI setting. This helps to prevent damage to the ceramic smooth top. Cycling at the HI setting is normal and can occur if the cookware is too small for the radiant element or if the cookware bottom is not flat (Refer to page 12 under Selecting Surface Cooking Utensils).

Element On & Hot Surface Indicator Lights

Your range is equipped with two different types of radiant surface control indicator lights that will glow on your range—the Element On indicator light and the Hot Surface indicator lights (See Figure 2).

The **Element On indicator lights** are located on the control panel above each radiant element control knob and will glow when a surface element is turned ON. A quick glance at this indicator light after cooking is an easy check to be sure ALL surface controls are turned OFF. The **Hot Surface indicator light** located on the control panel will glow when any surface cooking area heats up and will REMAIN ON until the glass cooktop has cooled to a MODERATE level.

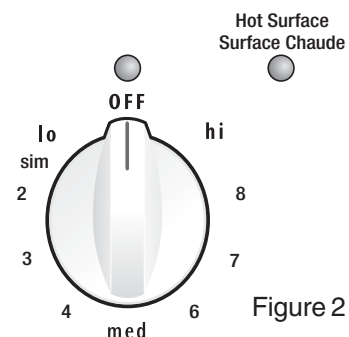

Figure 2

NOTE: Radiant elements have a limiter that allows the element to cycle ON and OFF, even at the HI setting. This helps to prevent damage to the ceramic smoothtop. Cycling at the HI setting is normal and will occur more often if the cookware is too small for the radiant element or if the cookware bottom is not flat.

Setting Surface Controls



Models with Ceramic Glass Cooktop (continued)

Operating Single Radiant Surface Elements

Depending on your model, your cooktop is equipped with 2, 3 or 4 Single Radiant Surface Elements.

To Operate the Single Surface Elements:

1. Place correctly sized cookware on the radiant surface element.
 2. Push in and turn the surface control knob in either direction to the desired setting (Figure 1). Turn the knob to adjust the setting if desired. Start most cooking operations on a higher setting and then turn to a lower setting to finish cooking. Each surface element provides a constant amount of heat at each setting. A glowing red surface heating area extending beyond the bottom edge of the cookware indicates the cookware is **too small** for the surface heating area.
 3. When cooking has completed, turn the surface control knob to OFF before removing the cookware. Note: The Surface Indicator light located on the control panel will come on when the control knob will be turn on and will continue to glow until the glass cooktop has cooled down to a moderate level. The light may remain on even though the controls are turned OFF.
- Note: See Figure 6 for recommended control settings.

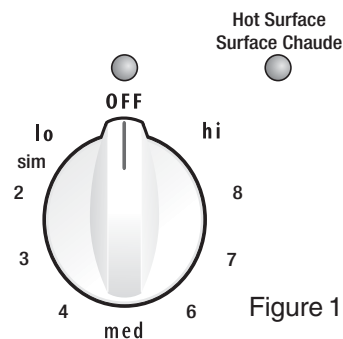

Operating the Dual Surface Radiant Element (some models)

Your model is equipped with 1 or 2 Dual Radiant Surface Elements at right front position (See Figure 2) and at left front position. Symbols on the control panel are used to indicate which coil of the dual radiant element will heat. The ○ symbol indicates that only the inner coil will heat (Figures 2 & 3). The ⊙ symbol indicates that both inner and outer coils will heat (Figures 4 & 5). You may switch from either coil setting at any time during cooking.

To Operate the Dual Surface Element:

1. Place correctly sized cookware on the dual surface element.
2. Push in and turn the control knob counterclockwise (See Figure 3) for smaller cookware or clockwise (See Figure 5) for larger cookware.
3. Turn the knob to adjust the setting if needed. Start most cooking operations on a higher setting and then turn to a lower setting to finish cooking. Each surface element provides a constant amount of heat at each setting. A glowing red surface heating area extending beyond the bottom edge of the cookware indicates the cookware is **too small** for the surface heating area.
4. When cooking has completed, turn the surface control knob to OFF before removing the cookware. **Note:** The Surface Indicator light located on the control panel will come on when the control knob will be turn on and will continue to glow until the glass cooktop has cooled down to a moderate level. The light may remain on even though the controls are turned OFF.

Note: See Figure 6 on page 10 for recommended control settings.

Element configuration, appearance and graphics of cooktops may be different

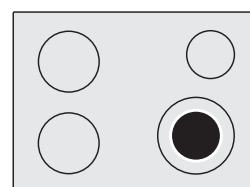

Figure 2

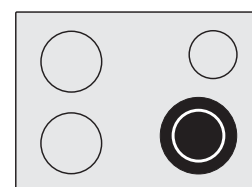

Figure 4

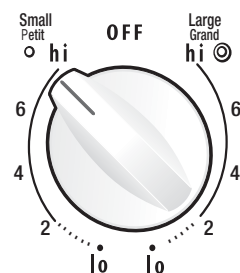

Figure 3

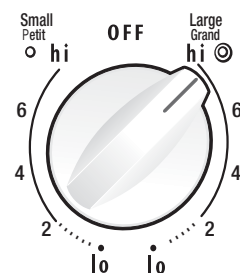

Figure 5

⚠ CAUTION Radiant surface elements may appear to have cooled after they have been turned off. The Hot surface indicator light will come on and will continue to glow until the glass cooktop has cooled down to a moderate level. **The glass surface may still be hot** and burns may occur if the glass surface is touched before it has cooled sufficiently.

Surface Cooking Settings

Use the chart (Figure 6) to determine the correct setting for the kind of food you are preparing.

Note: The size and type of cookware used will influence the setting needed for best cooking results.

Recommended Settings for Single and Dual Surface Elements	
Setting	Type of Cooking
HIGH (Hi)	Start most foods, bring water to a boil, pan broiling
MEDIUM HIGH (5-8)	Continue a rapid boil, fry, deep fat fry
MEDIUM (5)	Maintain a slow boil, thicken sauces and gravies, steam vegetables
MEDIUM LOW (2 - 4)	Keep foods cooking, poach, stew
LOW (Lo - 2)	Keep warm, melt, simmer

Figure 6

⚠ CAUTION Do not place plastic items such as salt and pepper shakers, spoon holders or plastic wrappings on top of the range when it is in use. These items could melt or ignite. Potholders, towels or wooden spoons could catch fire if placed too close to the surface elements.

Setting Surface Controls



Models with Ceramic Glass Cooktop (continued)

Setting Warm Zone Controls (some models)

To Operate the warm zone

Your appliance is equipped with a warm zone. The purpose of the warm zone is to keep hot cooked foods at serving temperature. Always start with hot food. It is not recommended to heat cold food on the warm zone.

Use the warm zone to keep cooked foods hot such as: vegetables, gravies, casseroles, soups, stews, breads, pastries and oven-safe dinner

All food placed on the warm zone should be covered with a lid or aluminum foil to maintain quality. For best results, when warming pastries or breads, the cover should have an opening to allow moisture to escape. **Do not use plastic wrap to cover food. Plastic may melt onto the surface and be very difficult to clean.**

Use only dishware, utensils and cookware recommended for oven and cooktop use on the warm zone.

CAUTION Unlike the surface elements, the warm zone will not glow red when it is hot. Always use potholders or oven mitts when removing food from the warm zone as cookware and plates will not be hot.

Appearance and graphics may be different

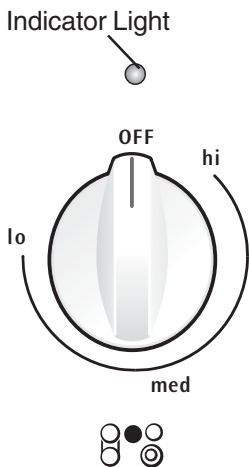

Indicator Lights

The **Hot Surface indicator light** is located above or below the warm zone control. It turns on when the control is set and will continue to glow until the glass cooktop has cooled down to moderate level.

To Set the Warm Zone Control

1. To set the control, push in and turn the knob. The temperatures are approximate, and are designated by **hi**, **med** and **lo**. However, the control can be set at any position between **hi** and **lo** for different levels of heating.
2. When done, turn the control to OFF position. The warm zone will remain warm until the **hot surface indicator light** goes off.

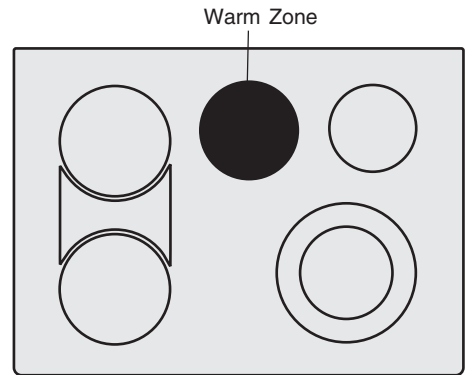

Element configuration, appearance and graphics of cooktops may be different

Temperature Selection

Refer to the chart for recommended heating levels. If a particular food is not listed, start with the medium level, and adjust as needed. Most food can be kept at serving temperatures by using the medium level.

Warm Zone Recommended Food Settings Chart	
<u>Food Item</u>	<u>Heating Level</u>
Breads/Pastries	lo
Casseroles	lo
Dinner Plate with Food	lo
Eggs	lo
Gravies	lo
Meats	med
Sauces	med
Soups (cream)	med
Stews	med
Vegetables	med
Fried Foods	hi
Hot Beverages	hi
Soups (liquid)	hi



Surface cooking

Surface Cooking (Continued)

Selecting Surface Cooking Cookware

Cookware should have flat bottoms that make good contact with the entire surface heating element. Check for flatness by rotating a ruler across the bottom of the cookware (See Figure 1). Be sure to follow the recommendations for using cookware as shown in Figure 2.

Note: The size and type of cookware used will influence the setting needed for best cooking results.

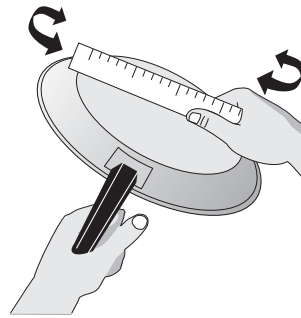
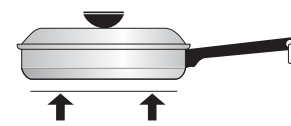

Figure 1

*CORRECT



- Flat bottom and straight sides.
- Tight fitting lids.
- Weight of handle does not tilt pan. Pan is well balanced.
- Pan sizes match the amount of food to be prepared and the size of the surface element.
- Made of a material that conducts heat well.
- Easy to clean.
- Always match pot diameter to element surface diameter.

INCORRECT



- Curved and warped pan bottoms.

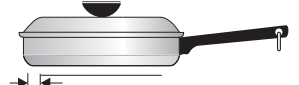

- Pan overhangs element by more than one-half inch.



- Pan is smaller than element.



- Heavy handle tilts pan.

Figure 2

Cookware Material types

The cookware material determines how evenly and quickly heat is transferred from the surface element to the pan bottom. The most popular materials available are:

ALUMINUM - Excellent heat conductor. Some types of food will cause it to darken (Anodized aluminum cookware resists staining & pitting). If aluminum pans slide across the ceramic glass cooktop, they may leave metal marks which will resemble scratches. Remove these marks immediately.

COPPER - Excellent heat conductor but discolors easily. May leave metal marks on ceramic glass (see Aluminum above).

STAINLESS STEEL - Slow heat conductor with uneven cooking results. Is durable, easy to clean and resists staining.

CAST IRON - A poor heat conductor however will retain heat very well. Cooks evenly once cooking temperature is reached. Not recommended for use on ceramic cooktops.

PORCELAIN-ENAMEL on METAL - Heating characteristics will vary depending on base material. Porcelain-enamel coating must be smooth to avoid scratching ceramic cooktops.

GLASS - Slow heat conductor. Not recommended for ceramic cooktop surfaces because it may scratch the glass.



Before Setting Oven Controls

Air Circulation in the Oven

For best air circulation and baking results allow 2-4" (5-10 cm) around the cookware for proper air circulation and be sure pans and cookware do not touch each other, the oven door, sides or back of the oven cavity. The hot air must circulate around the pans and cookware in the oven for even heat to reach around the food.

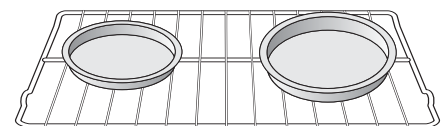

1 Oven Rack

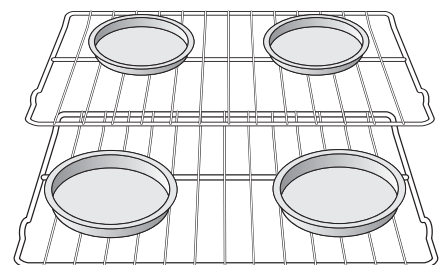

Multiple Oven Racks

Before Setting Oven Controls



⚠ CAUTION This range has a fan that will turn “ON” and “OFF” by itself to keep the electronics cool. It may continue to run after the range has been turned “OFF”, but may also stop immediately and then turn “ON” after a while.

Oven Vent Location -Models with Coil Elements

The oven is vented **through the right rear coil element**. When the oven is on, warm air is released through the vent. This venting is necessary for proper air circulation in the oven and good baking results. **DO NOT** block the vent. Doing so may cause cooking failures, fire or damage to the appliance.

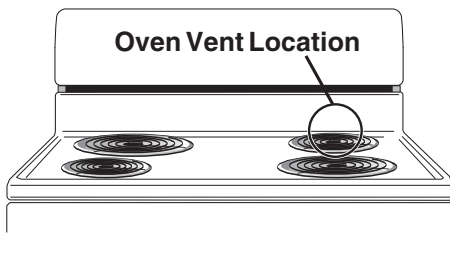

Oven Vent Location -Models with Ceramic Glass Cooktop

The oven vent is located **at right rear of the surface cooktop**. When the oven is on, hot air is released through the vents. This venting is necessary for proper air circulation in the oven and good baking results. **DO NOT** block the vent. Doing so may cause cooking failures, fire or damage to the appliance.

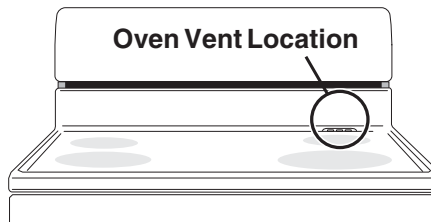

Removing and Replacing Oven Racks

To remove, pull the rack forward until it stops. Lift up front of rack and slide out.
To replace, fit the rack onto the guides on the oven walls. Tilt the front of the rack upward and slide the rack back into place.

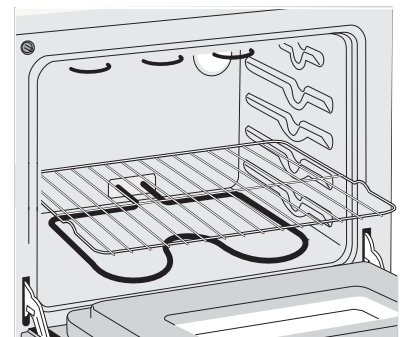

Arranging Oven Racks

ALWAYS ARRANGE OVEN RACKS WHEN THE OVEN IS COOL (PRIOR TO OPERATING THE OVEN). Always use oven mitts when the oven is hot.

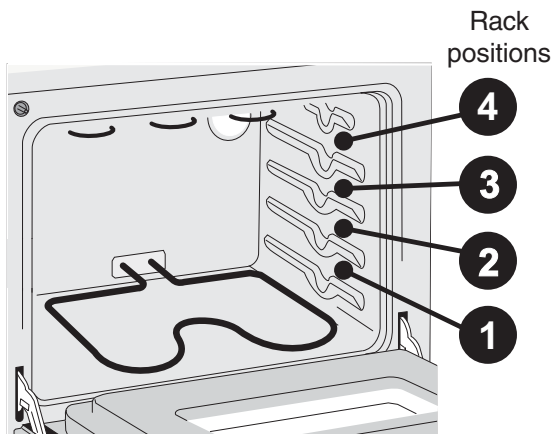

RECOMMENDED RACK POSITIONS FOR BROILING, BAKING & ROASTING

Food	Rack position
Broiling meats, chicken or fish	3 or 4
Cookies, cakes, pies, biscuits & muffins	2 or 3
1 rack	2 & 4
Multiple racks	2 & 4
Frozen pies, angel food cake, yeast, bread, casseroles, small cuts of meat or poultry	1 or 2
Turkey, roast or ham	1

Note: Always use caution when removing food.

Figure 1

Setting Oven Controls



Refer to the Electronic Oven Control Guide for oven settings.







Cooking Informations

Oven Baking

For best cooking results, heat the oven before baking cookies, breads, cakes, pies or pastries, etc... There is no need to preheat the oven for roasting meat or baking casseroles.

The cooking times and temperatures needed to bake a product may vary slightly from your previously owned appliance.

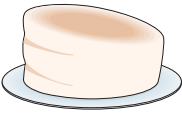
Baking Problems and Solutions Chart

Baking Problems	Causes	Corrections
Cookies and biscuits burn on the bottom. 	<ul style="list-style-type: none"> • Cookies and biscuits put into the oven before the preheating time is completed. • Oven rack overcrowded. • Dark pan absorbs heat too fast. 	<ul style="list-style-type: none"> • Allow oven to preheat to the selected temperature before placing food in oven. • Choose pan sizes that will permit 5.1 cm to 10.2 cm (2" to 4") of air space on all sides when placed in the oven. • Use a medium-weight aluminum baking sheet.
Cakes too dark on top or bottom. 	<ul style="list-style-type: none"> • Cakes put into the oven before preheating time is completed. • Rack position too high or low. • Oven too hot. 	<ul style="list-style-type: none"> • Allow oven to preheat to the selected temperature before placing food in the oven. • Use proper rack position for baking needs. • Set oven temperature 25°F/12°C lower than recommended.
Cakes not done in the center. 	<ul style="list-style-type: none"> • Oven too hot. • Incorrect pan size. • Pan not centered in oven. 	<ul style="list-style-type: none"> • Set oven temperature 25°F/12°C lower than recommended. • Use pan size suggested in recipe. • Use proper rack position and place pan so there is 5.1 cm to 10.2 cm (2" to 4") of space on all sides of pan.
Cakes not level. 	<ul style="list-style-type: none"> • Range not level. • Pan too close to oven wall or rack overcrowded. • Pan warped. 	<ul style="list-style-type: none"> • Place a marked glass measuring cup filled with water on the center of the oven rack. If the water level is uneven, refer to the installation instructions for leveling the range. • Be sure to allow 5.1 cm to 10.2 cm (2" to 4") of clearance on all sides of each pan in the oven. • Do not use pans that are dented or warped.
Foods not done when cooking time is up. 	<ul style="list-style-type: none"> • Oven too cool. • Oven overcrowded. • Oven door opened too frequently. 	<ul style="list-style-type: none"> • Set oven temperature 25°F/12°C higher than suggested and bake for the recommended time. • Be sure to remove all pans from the oven except the ones to be used for baking. • Open oven door only after shortest recommended baking time.

Cooking Informations



Broiling

Broiling is a method of cooking tender cuts of meat by direct heat under the broil element of the oven.

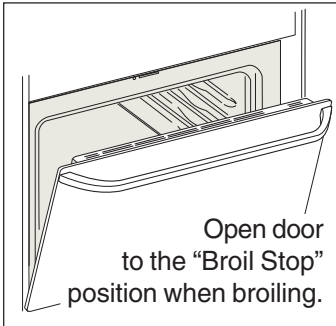

Always pull oven rack out to the "stop" position before turning or removing food.

Preheating

Preheating is suggested when searing rare steaks. (Remove all utensils from the oven before preheating. Foods will stick if placed on hot metal.) To preheat, set the oven control(s) to BROIL as instructed in the Electronic Oven Control Guide. Wait for the element to become red-hot, usually about 2 minutes. Preheating is not necessary when broiling meats well-done.

To Broil

Broil on one side until the food is browned; turn and cook on the second side. Season and serve. Always pull rack out to the "stop" position before turning or removing food.

Determining Broiling Times

Broiling times vary, so watch the food closely. Time not only depends on the distance from the element, but on the thickness and aging of meat, fat content and doneness preferred. The first side usually requires a few minutes longer than the second. Frozen meats also require additional time.

Broiling Tips (some models)

The broiler pan and its grid allow dripping grease to drain and be kept away from the high heat of the broiler.

DO NOT use the pan without its grid. DO NOT cover the grid with foil. The exposed grease could ignite.

CAUTION Should an oven fire occur, close the oven door and turn off the oven. If the fire continues, throw baking soda on the fire or use a fire extinguisher. **DO NOT** put water or flour on the fire. Flour may be explosive.

Broiler Clean-Up Tips (some models):

- To make cleaning easier, line the bottom of the broiler pan with aluminum foil. **DO NOT** cover the broiler grid with foil.
- To prevent grease from baking on, remove the broiler pan from the oven as soon as cooking is completed. Use hot pads because the broiler pan is extremely hot. Pour off grease. Soak the pan in **HOT**, soapy water.
- Clean the broiler pan as soon as possible after each use. If necessary, use soap-filled steel wool pads. Heavy scouring may scratch the grid.

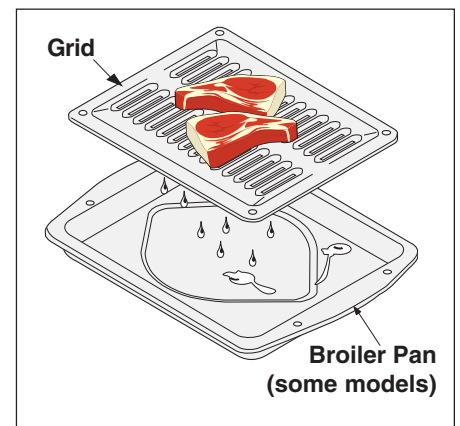



Care & Cleaning (Cleaning Chart)

Cleaning Various Parts of Your Range

Before cleaning any part of the range, be sure all controls are turned OFF and the range is COOL. REMOVE SPILLOVERS AND HEAVY SOILING AS SOON AS POSSIBLE. REGULAR CLEANING WILL REDUCE THE NUMBER OF MAJOR CLEANING LATER.

Surfaces

How to Clean

Aluminum & Vinyl

Use hot, soapy water and a cloth. Dry with a clean cloth.

Painted and Plastic Control Knobs, Body Parts, and Decorative Trim

Using a soft cloth, clean with mild dish detergent and water or a 50/50 solution of vinegar and water. Follow by rinsing the area with clean water; dry and polish with a soft cloth. Glass cleaners may be used if sprayed on a soft cloth first. **DO NOT** spray liquids directly on the control pad and display area. Do not use large amounts of water on the control panel - excess water on the control area may cause damage to the appliance. Do not use other liquid cleaners, abrasive cleaners, scouring pads, or paper towels - they will damage the finish. To remove control knobs, turn to the **OFF** position; grasp firmly and pull straight off the shaft. To replace knobs after cleaning, line up the flat sides of both the knob and the shaft; then push the knob into place.

Stainless Steel (some models) Oven Door & Drawer Front Panel and Decorative Trim

Clean **stainless steel** with hot, soapy water and a dishcloth. Rinse with clean water and a cloth. **Do not use cleaners with high concentrations of chlorides or chlorines.** Do not use harsh scrubbing cleaners. Only use kitchen cleaners that are especially made for cleaning stainless steel. Always be sure to rinse the cleaners from the surface as bluish stains may occur during heating that cannot be removed.

Surface Elements and Drip Bowls (some models)

Surface elements can be unplugged and removed to make cleaning the drip bowls easier. The surface elements clean themselves when they are turned on. Food spilled on a hot element will burn off. Food spilled on a cold element can be cleaned with a damp cloth any remaining soil will burn off the next time element is used. **NEVER IMMERSE A SURFACE ELEMENT IN WATER.** To remove surface element and drip bowls, follow the instructions under **General Cleaning**.

To clean drip bowls, wash in hot, soapy water or in the dishwasher. Rinse and dry while still warm. Hard-to-remove, burned-on soils can be removed by soaking the drip bowls for about 20 minute in a slightly diluted liquid cleanser or solution made of equal parts ammonia and water. A nylon scrubber may be used after soaking. **DO NOT** use abrasive cleanser or steel wool, as they will scratch the surface. Always rinse with clean water and polish, and dry with a soft cloth. To replace drip bowls and surface elements, follow the instructions under **General Cleaning**.

Porcelain Enamel

Broiler Pan and Insert (some models), Cooktop, Surface under Cooktop, Door Liner, Body Parts

Gentle scouring with a soapy scouring pad will remove most spots. Rinse with a 1:1 solution of clear water and ammonia. *If necessary*, cover difficult spots with an ammonia-soaked paper towel for 30 to 40 minutes. Rinse with clean water and a damp cloth, and then scrub with a soap-filled scouring pad. Rinse and wipe dry with a clean cloth. Remove all cleaners or the porcelain may become damaged during future heating. **DO NOT** use spray oven cleaners on the cooktop.

Oven Racks

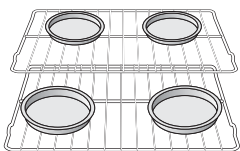

Oven racks should be removed, or else their finish will dull and their color turn slightly blue. If they do go through the self-clean cycle, wait until the oven has cooled, then remove the oven racks and rub their sides with wax paper or a cloth containing a small amount of baby or salad oil; this will make the oven racks glide easier back in and out of their positions.

Oven door



To clean oven door, wash with hot, soapy water and a clean cloth. **DO NOT** immerse the door in water.

DO NOT clean the oven door gasket. The oven door gasket is made of a woven material, on self cleaning models, which is essential for a good seal. Care should be taken not to rub, damage or remove the gasket.

Care & Cleaning



Coil Surface Element (some models)

⚠ CAUTION Be careful not to bend terminal ends when replacing elements after cleaning.

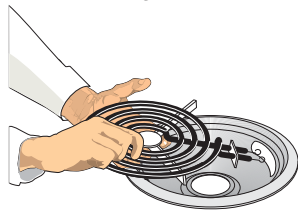

To Remove and Replace Surface Elements and Drip Bowls

ATTENTION: Never leave covers on the coil elements as they could be permanently damaged if the coil is turned on by accident.

Prior to cleaning the coil elements make sure they are cold and that control knobs are turned to OFF

Coil elements clean themselves when they are turned on.

Coil elements and drip bowls are removable and allow to clean the drip bowls.

To remove a coil element, push against the front edge and lift element up and out.

To clean by hand, wash the drip bowls in hot sudsy water. For hard to remove spots, use nylon scrubber with soap. Rinse and dry will still warm.

⚠ CAUTION Never immerse coil elements in water.

To Raise the Cooktop for Cleaning

1. Grasp the sides and lift from the front. A lift-up rod will support the top in its raised position. Only lift the top high enough to allow the support rod to rest in place under the front of the cooktop.
2. Clean underneath using a clean cloth and hot, soapy water.
3. To lower the top, lift the top slightly and lower the rod. Lower the range top down into the range frame.

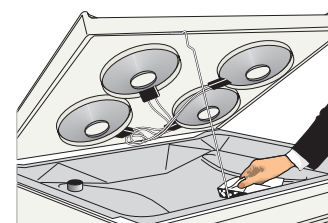

When lowering the lift-up range top, grasp the sides with fingertips only. Be careful not to pinch fingers. **DO NOT** drop or bend the range top when raising or lowering. This could damage the surface.

A rod swings up to support the top for cleaning underneath.

Porcelain enamel cooktop cleaning instructions (some models)

⚠ WARNING Do not use a cooktop cleaner on a hot cooktop. The fumes can be hazardous to your health, and can chemically damage the cooking surface.

⚠ CAUTION Before cleaning the surface cooktop, be sure the controls are turned to OFF and the cooktop is cool.

⚠ CAUTION **DO NOT use commercial oven cleaners** on the **exterior** surfaces including rangetop and door frame. Correct and consistent cleaning is essential to maintaining your porcelain enamel cooktop. If food spills and grease splatters are not removed, they may burn onto the surface of the cooktop and cause permanent discoloration.

Daily Cleaning

For normal soil:

1. Allow cooktop surface to cool.
2. Wipe off spills and splatters using a clean paper towel or a clean cloth with warm, soapy water.
3. If needed, use a soapy steel wool pad or other mild household cleaners.
4. Be sure to rinse off the cleaners or the porcelain may become damaged during future heating.

For heavy, burned-on soil:

1. Allow cooktop surface to cool.
2. Use a soap filled scouring pad with warm water or cover heavily soiled spots with a solution of clear water and ammonia. Scour gently. Rinse and wipe dry with a clean cloth.
3. If any soil remains, apply a few drops of a recommended cooktop cleaning cream on the spots and rub gently using a clean damp cloth or scouring pad. Buff with a dry cloth until all soil and cream are removed. Frequent cleaning with the cooktop cleaning cream leaves a protective coating which helps in preventing scratches and abrasions.

For sugary spillovers:

Sugary spills can chemically damage your cooktop surface. Therefore, you must begin cleaning the spills while the cooktop is still hot. Use caution when following the steps below.

1. Turn off all surface units and remove all pans immediately.
2. Wearing an oven mitt, wipe up carefully or move hot spills away from the element area with a clean damp cloth.
3. Allow the cooktop to cool. Follow the instructions above for heavy, burned-on soil.



Care & Cleaning

Ceramic Glass Cooktop Cleaning & Maintenance (some models)

Consistent and proper cleaning is essential to maintaining your Ceramic glass cooktop

Prior to using your cooktop for the first time, apply the recommended CERAMA BRYTE® Cleaning Creme to the ceramic surface. Clean and buff with a non abrasive cloth or pad. This will make cleaning easier when soiled from cooking. The special cooktop cleaning cream leaves a protective finish on the glass to help prevent scratches and abrasions.

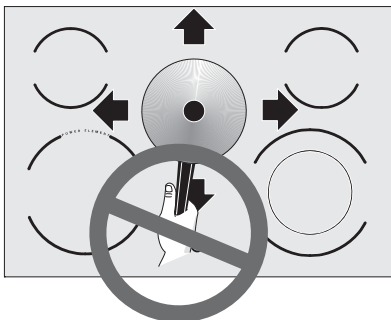

Sliding aluminum or copper clad bottom pans on the cooktop can cause metal markings on the cooktop surface. These marks should be removed **immediately** after the cooktop has cooled using the cooktop cleaning cream. Metal marks can become permanent if not removed prior to future use.

Cookware (cast iron, metal, ceramic or glass) with rough bottoms can mark or scratch the cooktop surface. **Do not slide anything metal or glass** across the cooktop. **Do not** use your cooktop as a cutting board or work surface in the kitchen. **Do not** cook foods directly on the cooktop surface without a pan. **Do not** drop heavy or hard objects on the glass cooktop, or they may crack it.

CAUTION Before cleaning the cooktop, be sure the controls are turned to **OFF** and the cooktop is **COOL**.

WARNING DO NOT use a cooktop cleaner on a hot cooktop. The fumes can be hazardous to your health, and can chemically damage the ceramic glass surface.

Cleaning Recommendations for the Ceramic Glass Cooktop

For light to moderate soil:

Apply a few drops of CERAMA BRYTE® Cleaning Creme directly to the cooktop. Use a paper towel or a Multi-Purpose No Scratch Scrub Sponge to clean the entire cooktop surface. Make sure the cooktop is cleaned thoroughly, leaving no residue. Do not use the sponge you use to clean the cooktop for any other purpose.

For heavy, burned on soil:

First, clean the surface as described above. Then, if soils remain, carefully scrape soils with a metal razor blade scraper, holding scraper at a 30 degree angle to the surface. Remove loosened soils with cooktop cleaning cream and buff surface clean.

CAUTION Damage to the ceramic glass cooktop may occur if you use any scrub pad other than a Multi-Purpose No Scratch Scrub Sponge.

Plastic or foods with a high sugar content:

These types of soils need be removed immediately if spilled or melted onto the ceramic cooktop surface. Permanent damage (such as pitting of the cooktop surface) may occur if not removed **immediately**. After turning the surface elements **OFF**, use a razor blade scraper or a metal spatula with a mitt and scrape the soil from the hot surface (as illustrated). Allow the cooktop to cool, and use the same method for heavy or burned on soils.

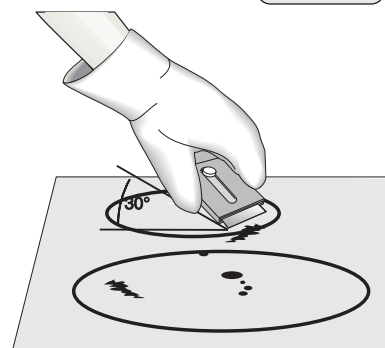

Do not use the following on the ceramic glass cooktop:

- Do not use abrasive cleaners and scouring pads, such as metal and some nylon pads. They may scratch the cooktop, making it more difficult to clean.
- Do not use harsh cleaners, such as chlorine bleach, ammonia or oven cleaners, as they may etch or discolor the cooktop.
- Do not use dirty sponges, cloths or paper towels, as they can leave soil or lint on the cooktop which can burn and cause discoloration.



Special Caution for Aluminum Foil and Aluminum Cooking Utensils

- **Aluminum foil:** Use of aluminum foil will damage the cooktop. Do not use under any circumstances.
- **Aluminum utensils:** Since the melting point of aluminum is much lower than that of other metals, care must be taken when aluminum pots or pans are used. Pans that boil dry may permanently damage cooktop by breaking, fusing to, or marking it.

Care & Cleaning



Care and Cleaning of Stainless Steel (Some Models)

Some models are equipped with stainless steel exterior parts. Special care and cleaning are **required** for maintaining the appearance of stainless parts. Please refer to the table provided at the beginning of the **General Care & Cleaning** section in this Use & Care Guide.

Oven Cleaning

Cleaning the Manual Clean Oven (non self-clean oven, some models)

Make sure the oven is cool and that all control knobs are in OFF position. Cleaning the oven is a lot easier when the door is removed.

1. Remove the oven door; see under **To Remove and Replace the Oven Door** section.
2. Empty the oven including the racks.
3. You can wash your broiler pan, grid and racks in the kitchen sink.
4. Clean oven lining thoroughly with soap and a wet cloth and wipe with a dry cloth.

To remove burned-on fat on oven walls, moisten soiled parts with household ammonia, using a wet cloth. Follow suggested manufacturer's cleaning method. (Do not remove the oven door when using ammonia.)

Complete cleaning with a damp cloth and use a fine steel wool scouring agent if necessary.

The lower element can be moved up for cleaning purposes.

5. Replace racks in the oven. Reinstall oven door.

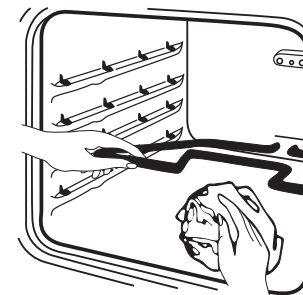

Cleaning the Self-Clean Oven (some models)

Adhere to the following cleaning precautions:

- Allow the oven to cool before cleaning.
- Wear rubber gloves when cleaning any exterior parts of the oven manually.

CAUTION During the self-clean cycle, the outside of the wall oven can become very hot to the touch. **DO NOT** leave small children unattended near the appliance.

CAUTION The health of some birds is extremely sensitive to the fumes given off during the self-cleaning cycle of any range. Move birds to another well ventilated room.

CAUTION Before cleaning any part of the oven, be sure the electronic oven control is turned off or else push **CANCEL** pad. Wait until the oven is cool.

DO NOT use commercial oven cleaners or oven protective coatings in or around any part of the self-cleaning oven. **DO NOT** clean the oven door gasket. The gasket on the oven door is essential for a good seal. Care should be taken not to rub, damage or move the gasket. **DO NOT use any cleaning materials on the gasket. Doing so could damage it. DO NOT use aluminum foil to line the oven bottom.** This may affect cooking or foil could melt and damage the oven surface.

A self-cleaning oven cleans itself with high temperatures (well above cooking temperatures) which eliminate soil completely or reduce it to a fine powdered ash you can wipe away with damp cloth.

Preparing the Oven for Self-Cleaning

1. Remove all excess spillovers in the oven cavity before starting the self-cleaning cycle. To clean, use hot soapy water and a cloth. Large spillovers can cause heavy smoke or fire when subjected to high temperatures. **DO NOT** allow food spills with a high sugar or acid content (such as tomatoes, sauerkraut, fruit juices or pie filling) to remain on the surface as they may cause a dull spot even after cleaning.
2. Clean any soil from the oven frame and the door liner (see illustration). These areas heat sufficiently during self-cleaning cycle to burn soil on. Clean with soap and water.
3. Remove all utensils and any foil. These items do not withstand high cleaning temperatures.
4. Oven racks may be left in the oven or may be removed. If they go through the clean cycle, their color will turn slightly dull. After the cycle is completed and the oven has cooled, rub the sides of the racks with wax paper or a cloth containing a small amount of baby oil or salad oil. This will make the racks glide easier.





Care & Cleaning

Oven Cleaning (Continued)

Cleaning the Self-Clean Oven (some models, Continued)

What to Expect During Cleaning

While the oven is in operation, the oven heats to temperatures much higher than those used in normal cooking. Sounds of metal expansion and contraction are normal. Odor is also normal as the food soil is being removed. Smoke may appear through the oven vent, located on the top of the control panel.

If heavy spillovers are not wiped up before cleaning, they may flame and cause more smoke and odor than usual. This is normal and safe and should not cause alarm. If available, use an exhaust fan during the self-cleaning cycle.

NOTE: A smoke eliminator in the oven vent converts most of the soil into a colorless vapor.

Setting the Controls for Self-Clean Cycle

For the setting of the clean cycle, refer to Timer or Electronic Oven Control Guide.

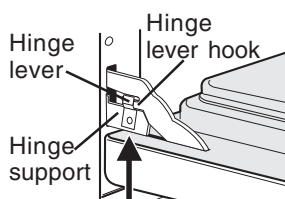

Lock engaged for door removal - Figure 1



- Door removed from the oven - Figure 2

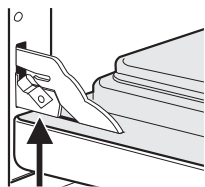

Lock in normal position - Figure 3

Removing and Replacing the Oven Door

CAUTION The door is heavy. For safe, temporary storage, lay the door flat with the inside of the door facing down.

To Remove Oven Door:

1. Open the door to the fully opened position.
2. Pull up the hinge lever located on each hinge supports and engage it into the hinge lever hook (Figure 1). You may have to apply a little downward pressure on the door to pull the lever fully over the hinge lever hook.
3. Grab the door by the sides and pull the bottom of the door up and toward you to disengage the hinge supports. Keep pulling the bottom of the door toward you while rotating the top of the door toward the range to completely disengage the hinge support (Figure 2).
4. To clean oven door, follow the instructions provided in the **Cleaning Chart**.

To Replace Oven Door:

1. Grab the door by the sides; place the hinge support in the hinge slot. Open the door to the fully opened position.
2. Disengage the lever from the hinge lever hook on each side (Figure 3).
Note: Make sure the hinge supports are fully engaged before unlocking the hinge lever.
3. Close the oven door.

Special Door Care Instructions - Most oven doors contain glass that can break.

Read the following recommendations:

1. Do not close the oven door until all the oven racks are fully in place.
2. Do not hit the glass with pots, pans, or any other object.
3. Scratching, hitting, jarring or stressing the glass may weaken its structure causing an increased risk of breakage at a later time.

Care & Cleaning



Storage Drawer with extensible glides (some models)

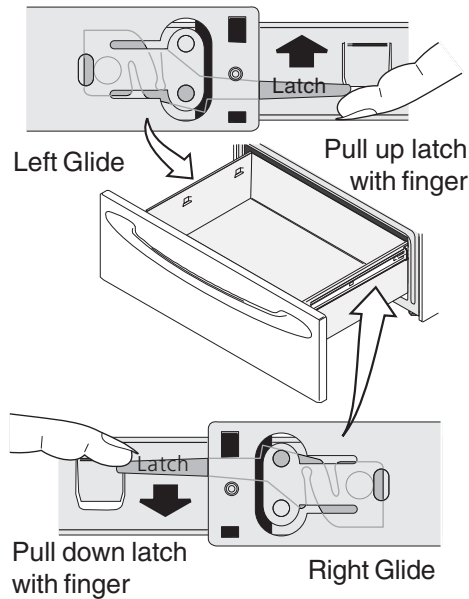

Figure 1

To remove Warmer Drawer:

1. Open the drawer to the fully opened position.
2. Locate the latches on both sides of the warmer drawer. (See Figure 1)
3. Pull up on the left glide latch and push down on the right glide latch. (See Figure 1)
4. Pull the drawer away from the range.
5. To clean warmer drawer, gently scour with a soapy scouring pad, this will remove most spots. Rinse with a 1:1 solution of clear water and ammonia. If necessary, cover difficult spots with an ammonia-soaked paper towel for 30 to 40 minutes. Rinse with clean water and a damp cloth. Remove all cleaners or the porcelain may become damaged during future heating. **DO NOT** use spray oven cleaners on the cooktop.

To Replace Warmer Drawer:

1. Align the glide latches on both sides of the drawer with the slots on the drawer.
2. Push the drawer back into the range.

Regular Storage Drawer (some models)

Use the storage drawer for storing cooking utensils. The drawer can be removed to facilitate cleaning under the range. Use care when handling the drawer.

Removing and Replacing Storage Drawer

To remove the drawer:

1. Pull empty drawer out to the roller guide stop.
2. Tilt the drawer up and pull it out over the rollers.

To replace the drawer:

1. Insert the rear end of the drawer into the opening.
2. Fit the drawer end rollers onto the guide rails.
3. Push the drawer in until it stops, then lift to allow the rollers to clear the roller guide stop, and push in.

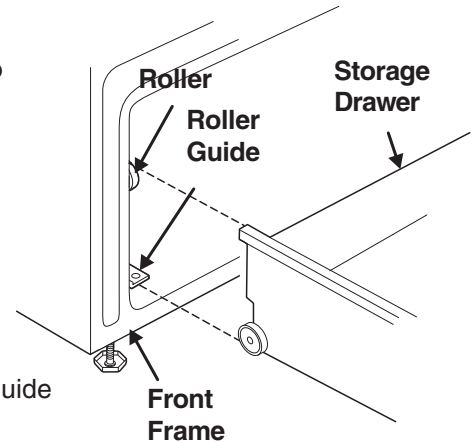

Figure 2



Care & Cleaning

Changing the Surface Light (some models)

CAUTION Be sure all surface element control knobs are turned off “●” and elements are cool.

Use switch located on or underneath the control panel to turn the surface light ON/OFF. Replace the surface light, if after repeated attempts to turn it on you are not successful. It is recommended to use a little mirror to replace the surface light.

To remove and replace the fluorescent light:

1. Place the little mirror to see in it the fluorescent tube.
1. Place your fingers under the tube located underneath and in the middle of the control panel.
2. To remove, turn the tube 90° then pull it down and out of its sockets.
3. To replace the tube, engage the new tube into the sockets, then rotate and snap the tube in place. Turn on the surface light to make sure it will lit.

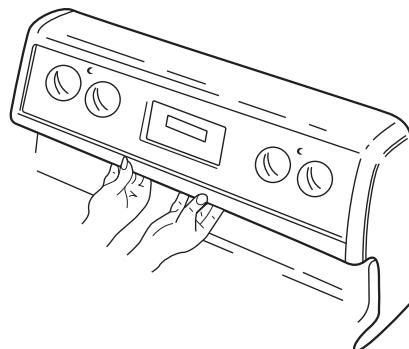

Changing the Oven Light

CAUTION Be sure the oven is unplugged and all parts are COOL before replacing the oven light bulb. Do not turn the oven light on during the self-cleaning cycle. High temperature will reduce lamp life.

The interior oven light will turn on automatically when the oven door is opened.

The oven light may be turned on when the door is closed by using the oven light switch located on the control panel.

On a self clean oven the lamp is covered with a glass shield held in place by a wire holder.

THIS GLASS SHIELD MUST BE IN PLACE WHENEVER THE OVEN IS IN USE.

To replace the light bulb:

CAUTION: BE SURE OVEN IS COOL

1. Turn the power off at the main source.
2. Wear a leather-faced glove for protection against possible broken glass.
3. Replace bulb with a 40 watt appliance bulb only.
4. For self-cleaning oven, press wire holder to one side to release glass shield, change bulb and be sure to replace glass shield.



Adjusting Your Oven Temperature

For instructions on how to adjust the oven temperature refer to the electronic oven control guide.

Before you call *Solutions to Common Problems*



Before you call for service, review this list. It may save you time and expense. The list includes common occurrences that are not the result of defective workmanship or materials in this appliance. You will be charged for a service call while the appliance is in warranty if the problem is not caused by defective product workmanship or materials.

Your new appliance is a carefully engineered product. Many times, what appears to be a reason to call for service requires nothing more than a simple adjustment you can easily make in your own home or is normal operating characteristic of appliance under certain conditions.

This list is applicable to a variety of models; some of the items will not necessarily apply to your appliance.

OCCURRENCE	POSSIBLE CAUSE/SOLUTION
Range is not level.	(1) Poor installation. Place oven rack in center of oven. Place a level on the oven rack. Adjust leveling legs at base of range until the rack is level. When range is level, cooktop may appear out of alignment if countertop is not level. (2) Weak, unstable floor. Be sure floor is level and can adequately support range. Contact a carpenter to correct sagging or sloping floor. (3) Kitchen cabinet misalignment may make range appear to be unlevel. Be sure cabinets are square and have sufficient room for range clearance.
Cannot move appliance easily. Appliance must be accessible for service.	(1) Cabinets not square or are built in too tight. Contact a cabinet maker to correct the problem. (2) Contact builder or installer to make appliance accessible. (3) Carpeting interferes with range. Provide sufficient space so range can be lifted over carpet.
Entire range or oven does not operate.	(1) Make sure cord/plug is tightly into outlet. (2) Service wiring is not complete. (3) Power outage. Check house lights to be sure. Call your local electric company for service.
Oven control beeps and displays an F error code.	(1) This oven is equipped with a state of the art electronic oven controller. Among the many features is a full time oven circuit diagnostics system. The controller constantly monitors the internal circuitry as well as several crucial oven circuits to insure they are all operating correctly. If at any time one of these systems fails, the controller will immediately stop the current operation and beep continuously (flashing an error code of "F1, F2, F3", or "F9" in the controller display window. (2) Electronic control has detected a fault condition. Press STOP/CLEAR to clear the display and stop the beeping. Reprogram oven. If fault remains, record fault number. Press STOP/CLEAR and contact authorized servicer.
Oven light does not work.	(1) Replace or tighten bulb. See Changing Oven Light in this owner's Guide for instructions.
Electrical outlet does not work.	(1) Reset the breaker located underneath the control panel. (2) If the problem returns, verify if the accessory that you connect uses more than 1800 watts. Verify if the accessory is defective. (3) If the problem is not resolved, contact an authorized servicer.
Surface unit does not heat.	(1) No power to the appliance. Check steps under "Entire Range or Oven Does Not Operate" in this Before you Call checklist. (2) Incorrect control setting. Make sure the correct control is on for the surface unit to be used. (3) Incorrect control setting. Make sure the correct control is on for the surface unit to be used.
Surface units too hot or not hot enough.	(1) Lightweight or warped pans used. Use only flat, evenly balanced, medium or heavyweight cookware. Flat pans heat better than warped pans. Cookware materials and weight of the material affect heating. Heavy-and medium- weight pans heat evenly. Because lightweight pans heat unevenly, foods may burn easily.
Drip bowls are pitting or rusting.	(1) Foods with acids, such as tomatoes, if allowed to stand in/on bowls will cause corrosion. Remove and wash drip bowls as soon as possible after spillover. (2) Normal environment. Houses along sea coast are exposed to salt air. Protect bowls as much as possible from direct exposure to salt air.
Drip bowls turning color or distorted out of shape.	(1) Bottom surface of cookware extends beyond surface elements and touches cooktop surface. This can cause high enough temperatures to discolor the drip bowls. DO NOT use cookware of this type. Pan sizes should be matched to the size of the element. Replacement drip bowls may be purchased from your dealer.



Before you call *Solutions to Common Problems*

OCCURRENCE	POSSIBLE CAUSE/SOLUTION
Scratches or abrasions on cooktop surface.	(1) Coarse particles such as salt or sand between cooktop and utensils can cause scratches. Be sure cooktop surface and bottoms of utensils are clean before usage. Small scratches do not affect cooking and will become less visible with time. (2) Cleaning materials not recommended for ceramic-glass cooktop have been used. See “Cooktop Cleaning - Ceramic Glass Cooktop Models” section under General Cleaning. (3) Cookware with rough bottom has been used. Use smooth, flat-bottomed cookware.
Metalmarks.	(1) Sliding or scraping of metal utensils on cooktop surface. Do not slide metal utensils on cooktop surface. Use a ceramic-glass cooktop cleaning cream to remove the marks. “Cooktop Cleaning - Ceramic Glass Cooktop Models” section under General Cleaning.
Brown streaks or specks.	(1) Boilovers are cooked onto surface. Use razor blade scraper to remove soil. “Cooktop Cleaning - Ceramic Glass Cooktop Models” section under General Cleaning.
Areas of discoloration with metallic sheen.	(1) Mineral deposits from water and food. Remove using a ceramic-glass cooktop cleaning cream. Use cookware with clean, dry bottoms.
Poor baking results.	(1) Many factors affect baking results. Make sure the proper rack position is used. Center food in the oven and space pans to allow air to circulate. Allow the oven to preheat to the set temperature before placing food in the oven. Try adjusting the recipe's recommended temperature or baking time. If you feel the oven is too hot or cool, see “ Adjusting Oven Temperature ” in the Electronic Oven Control guide.
Fan noise during cooking operation.	(1) A cooling fan may automatically turn on and off to cool internal parts. It is normal, and the fan may continue to run even after oven is turned off.
Flames inside oven or smoking from vent.	(1) Excessive spillovers in oven. This is normal, especially for pie spillovers or large amounts of grease on the oven bottom. Wipe up excessive spillovers before starting the self-clean cycle. If flames or excessive smoke are present, stop the self-clean cycle and follow the steps under “Stopping or Interrupting the Self-Cleaning Cycle” in the Electronic Oven Control guide.
Oven smokes excessively during broiling.	(1) Control(s) not set properly. Follow instructions under “ Setting Oven Controls ”. (2) Make sure oven is opened to Broil Stop Position . (3) Meat too close to the element. Reposition the rack to provide proper clearance between the meat and the element. Preheat broil element. (4) Grid on broiler pan wrong side up and grease not draining. Always place grid on the broiler pan with ribs up and slots down to allow grease to drip into pan. (5) Grease has built up on oven surfaces. Regular cleaning is necessary when broiling frequently. Old grease or food spatters cause excessive smoking. (6) Control(s) not set properly. Follow instructions under “Oven Cleaning” in the Electronic Oven Control Guide.
Self-cleaning cycle does not work.	(1) Self-cleaning cycle was interrupted. Follow steps under “Stopping or Interrupting the Self-Cleaning Cycle” in the Electronic Oven Control Guide.
Soil not completely removed after self-cleaning cycle.	(1) Failure to clean bottom, front top or oven, frame or door area outside oven seal. These areas are not in the self-cleaning area, but get hot enough to burn on residue. Clean these areas before the self-cleaning cycle is started. Burned-on residue can be cleaned with a stiff nylon brush and water or nylon scrubber. Be careful not to damage the oven seal. (2) Excessive spillovers in oven. Set self-clean cycle for a longer cleaning time.

Avoid Transportation Damage to your Range

If you have to move your range into/out of your residence or when moving to a new home, it is suggested that you take the following precautions:

(1) Screw in the levelling legs under the range. **(2)** Remove the racks and other utensils from the oven, and from the lower drawer. **(3)** Use adhesive tape to firmly secure the door and the drawer to the side panels. Also attach the electric power cord in the same manner. **(4)** Use a two-wheeled trolley with strap and fasten the range to it. Cover the appliance with a heavy blanket to prevent scratches and dents. **(5)** Avoid pulling or pushing the control panel when moving the appliance.