

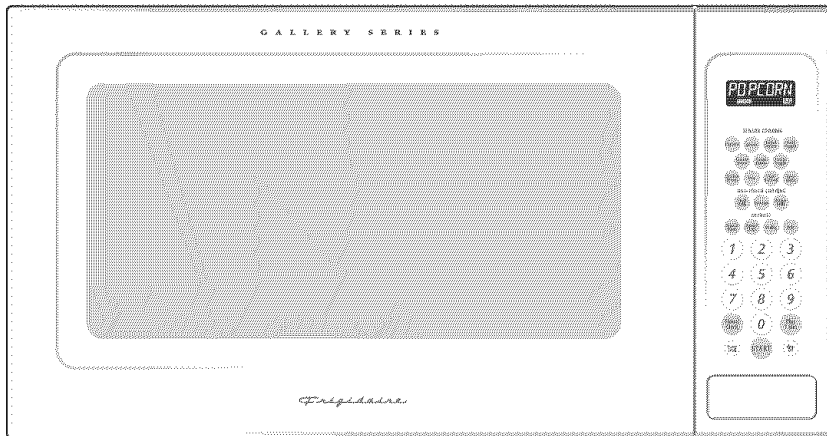









# Use & Care Manual

## Microwave Oven

GLMB209DB, GLMB209DS, GLMB209DQ  
PLMB209DC, CPLMB209DC



Welcome & Congratulations ....	2	
Important Safety Instructions ..	2-7	
Part Names .....	8	
Before Operating .....	9	
Manual Operation .....	9	
Operating Instructions .....	10-14	
Cleaning and Care .....	15	
Service Call Check .....	15	
Specifications .....	16	
Warranty .....	17	

Visit the Frigidaire Web Site at:  
<http://www.frigidaire.com>



## Welcome & Congratulations

### Questions?

**1-800-944-9044**

(United States)

**1-866-729-5199**

(Canada)

Please attach sales receipt here for future reference.

Congratulations on your purchase of a new microwave oven! At **Electrolux Home Products**, we are very proud of our product and are completely committed to providing you with the best service possible. Your satisfaction is our number one priority.

We know you'll enjoy your new microwave oven and **Thank You** for choosing our product. We hope you consider us for future purchases.

### PLEASE CAREFULLY READ AND SAVE THESE INSTRUCTIONS

This Use & Care Manual provides specific operating instructions for your model. Use your microwave oven only as instructed in this manual. These instructions are not meant to cover every possible condition and situation that may occur. Common sense and caution must be practiced when installing, operating and maintaining any appliance.

**Please record your model and serial numbers below for future reference.**

Model Number: \_\_\_\_\_

Serial Number: \_\_\_\_\_

Purchase Date: \_\_\_\_\_

### NEED HELP?

**Visit the Frigidaire Web Site at: <http://www.frigidaire.com>**

Before you call for service, there are a few things you can do to help us serve you better.

#### ***Read this manual.***

It contains instructions to help you use and maintain your microwave oven properly.

***If you received a damaged Microwave Oven...*** immediately contact the dealer (or builder) that sold you the Microwave Oven.

#### ***Save time and money.***

Check the section titled "Service Call Check". This section helps you solve common problems that might occur. If you do need service, you can relax knowing help is only a phone call away. A list of toll-free customer service numbers is included in the back of this manual. Or call Frigidaire Customer Services at 1-800-944-9044, 24 hours a day, 7 days a week.



## Important Safety Instructions



### **PRECAUTIONS TO AVOID POSSIBLE EXPOSURE TO EXCESSIVE MICROWAVE ENERGY**

*For your safety the information in this manual must be followed to minimize the risk of fire or explosion or to prevent property damage, personal injury or loss of life.*

- **Do Not Attempt** to operate this microwave oven with the door open since open-door operation can result in harmful exposure to microwave energy. It is important not to defeat or tamper with the safety interlocks.
- **Do Not Place** any object between the microwave oven front face and the door or allow soil or cleaner residue to accumulate on sealing surfaces.
- **Do Not Operate** the microwave oven if it is damaged. It is particularly important that the microwave oven door close properly and that there is no damage to the:
  1. door (bent)
  2. hinges and latches (broken or loosened)
  3. door seals and sealing surfaces.
- **The Microwave Oven Should Not** be adjusted or repaired by anyone except properly qualified service personnel.

# Important Safety Instructions



**WARNING** This symbol will help alert you to situations that may cause serious bodily harm, death or property damage.

**CAUTION** This symbol will help alert you to situations that may cause bodily injury or property damage.

## READ ALL INFORMATION BEFORE USING

**WARNING** To reduce the risk of fire, burns, electric shock, injury to persons, or exposure to excessive microwave energy when using your appliance, follow basic *precautions, including the following sections.*

- Read all instructions before using the appliance.
- Read and follow the specific **“PRECAUTIONS TO AVOID POSSIBLE EXPOSURE TO EXCESSIVE MICROWAVE ENERGY”** on page 2.
- This appliance must be grounded. Connect only to properly grounded outlet. See **“ELECTRICAL GROUNDING INSTRUCTIONS”** on page 5.
- Install or locate this appliance only in accordance with the provided installation instructions.
- Some products such as whole eggs and sealed containers—for example, closed glass jars—are able to explode and should not be heated in this microwave oven.
- Use this appliance only for its intended use as described in this manual. Do not use corrosive chemicals or vapors in this appliance. This type of microwave oven is specifically designed to heat, cook or dry food. It is not designed for industrial or laboratory use.
- As with any appliance, close supervision is necessary when used by children.
- Do not operate this appliance if it has a damaged cord or plug, if it is not working properly or if it has been damaged or dropped.
- This appliance should be serviced only by qualified service personnel. Contact nearest Electrolux Authorized Servicer for examination, repair or adjustment.
- Do not cover or block any openings on the appliance.
- Do not store or use this appliance outdoors. Do not use this product near water—for example, near a kitchen sink, in a wet basement or near a swimming pool, or similar locations.
- Do not immerse cord or plug in water.
- Keep cord away from heated surfaces.
- Do not let cord hang over edge of table or counter.
- See door surface cleaning instructions on page 15.
- To reduce the risk of fire in the microwave oven cavity:
  - Do not overcook food. Carefully attend appliance when paper, plastic or other combustible materials are placed inside the microwave oven to facilitate cooking.
  - Remove wire twist-ties from paper or plastic bags before placing bag in microwave oven.
  - **If materials inside the microwave oven should ignite, keep microwave oven door closed, turn microwave oven off and disconnect the power cord or shut off power at the fuse or circuit breaker panel.**
  - Do not use the cavity for storage purposes. Do not leave paper products, cooking utensils or food in the cavity when not in use.
- Liquids, such as water, coffee or tea are able to be overheated beyond the boiling point without appearing to be boiling. Visible bubbling or boiling when the container is removed from the microwave oven is not always present. **THIS COULD RESULT IN VERY HOT LIQUIDS SUDDENLY BOILING OVER WHEN A SPOON OR OTHER UTENSIL IS INSERTED INTO THE LIQUID.**
  - To reduce the risk of injury to persons:
    - Do not overheat the liquid.
    - Stir the liquid both before and halfway through heating it.
    - Do not use straight-sided containers with narrow necks. Use a wide-mouthed container.
    - After heating, allow the container to stand in the microwave oven at least for 20 seconds before removing the container.
    - Use extreme care when inserting a spoon or other utensil into the container.
- If the microwave oven is installed as a built-in, observe the following instructions:
  - Do not mount over a sink.
  - Do not store anything directly on top of the appliance surface when the appliance is in operation.
- If the microwave oven light fails, consult a **ELECTROLUX AUTHORIZED SERVICER.**

## SAVE THESE INSTRUCTIONS



## Important Safety Instructions

### UNPACKING AND EXAMINING YOUR MICROWAVE OVEN

#### Remove:

- All packing materials from inside the microwave oven cavity; however, **DO NOT REMOVE THE WAVEGUIDE COVER**, which is located on the right cavity wall. Read enclosures and **SAVE** the Use and Care Manual.
- The feature sticker, if there is one, from the outside of the door.

Check the microwave oven for any damage, such as misaligned or bent door, damaged door seals and sealing surfaces, broken or loose door hinges and latches and dents inside the cavity or on the door. If there is any damage, do not operate the microwave oven and contact your dealer or ELECTROLUX AUTHORIZED SERVICER.

### CHOOSING A LOCATION FOR YOUR MICROWAVE OVEN ON THE COUNTER

You will use the microwave oven frequently so plan its location for ease of use. It's wise, if possible, to have counter space on at least one side of the microwave oven. Allow at least 2 inches on the sides, top and at the rear of the microwave oven for air circulation.

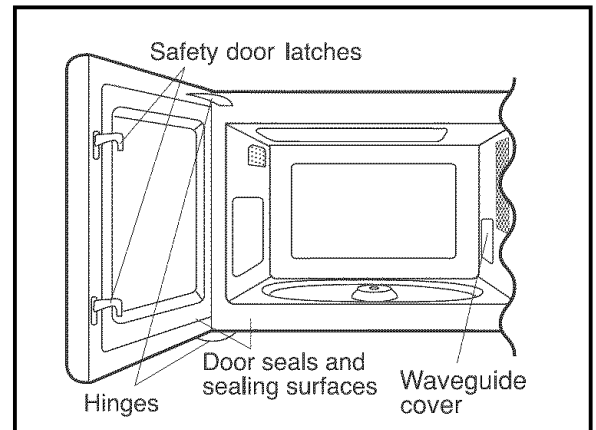

# Important Safety Instructions



## GROUNDING INSTRUCTIONS

This appliance must be grounded. This microwave oven is equipped with a cord having a grounding wire with a grounding plug. It must be plugged into a wall receptacle that is properly installed and grounded in accordance with the National Electrical Code and local codes and ordinances. In the event of an electrical short circuit, grounding reduces risk of electric shock by providing an escape wire for the electric current.

**WARNING** Improper use of the grounding plug can result in a risk of electric shock.

## Electrical Requirements

Check Installation Instructions for proper location for the power supply.

The electrical requirements are a 120 volt 60 Hz, AC only, 15 amp. or more protected electrical supply. It is recommended that a separate circuit serving only the microwave oven be provided.

The microwave oven is equipped with a 3-prong grounding plug. It must be plugged into a wall receptacle that is properly installed and grounded. **DO NOT UNDER ANY CIRCUMSTANCES CUT OR REMOVE THE GROUNDING PIN FROM THE PLUG.**

### NOTES:

1. If you have any questions about the grounding or electrical instructions, consult a qualified electrician or service person.
2. Neither Electrolux nor the dealer can accept any liability for damage to the microwave oven or personal injury resulting from failure to observe the correct electrical connection procedures.

## Radio or TV Interference

Should there be any interference caused by the microwave oven to your radio or TV, check that the microwave oven is on a different electrical circuit, relocate the radio or TV as far away from the microwave oven as feasible or check position and signal of receiving antenna.

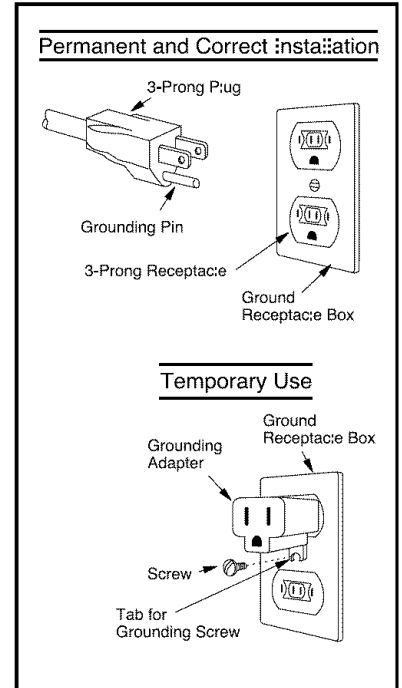



## Important Safety Instructions

### ABOUT YOUR MICROWAVE OVEN

This Use and Care Manual is valuable: read it carefully and always save it for reference.

A good microwave cookbook is a valuable asset. Check it for microwave cooking principles, techniques, hints and recipes.

**NEVER** use the microwave oven without the turntable and support nor turn the turntable over so that a large dish could be placed in the microwave oven. The turntable will turn both clockwise and counterclockwise.

**ALWAYS** have food in the microwave oven when it is on to absorb the microwave energy.

When using the microwave oven at power levels below 100%, you may hear the magnetron cycling on and off. It is normal for the exterior of the microwave oven to be warm to the touch when cooking or reheating.

Condensation is a normal part of microwave cooking. Room humidity and the moisture in food will influence the amount of moisture that condenses in the microwave oven. Generally, covered foods will not cause as much condensation as uncovered ones. Ventilation openings must not be blocked.

The microwave oven is for food preparation only. It should not be used to dry clothes or newspapers.

All microwave ovens are rated by using the IEC Test Procedure as 1200 watts, except for the CPLMB209DC which is 1100 watts. In using recipes or package directions, check food a minute or two before the minimum time and add time accordingly.

### ABOUT MICROWAVE COOKING

- Arrange food carefully. Place thickest areas towards outside of dish.
- Watch cooking time. Cook for the shortest amount of time indicated and add more as needed. Food severely overcooked can smoke or ignite.
- Cover foods while cooking. Check recipe or cookbook for suggestions: paper towels, wax paper, microwave plastic wrap or a lid. Covers prevent splattering and help foods to cook evenly.
- Shield with small flat pieces of aluminum foil any thin areas of meat or poultry to prevent overcooking before dense, thick areas are cooked thoroughly.
- Stir foods from outside to center of dish once or twice during cooking, if possible.
- Turn foods over once during microwaving to speed cooking of such foods as chicken and hamburgers. Large items like roasts must be turned over at least once.
- Rearrange foods such as meatballs halfway through cooking both from top to bottom and from the center of the dish to the outside.
- Add standing time. Remove food from microwave oven and stir, if possible. Cover for standing time which allows the food to finish cooking without overcooking.
- Check for doneness. Look for signs indicating that cooking temperatures have been reached.

#### Doneness signs include:

- Food steams throughout, not just at edge.
- Center bottom of dish is very hot to the touch.
- Poultry thigh joints move easily.
- Meat and poultry show no pinkness.
- Fish is opaque and flakes easily with a fork.

### ABOUT FOODS

- Do not pop popcorn in your microwave oven unless in a special microwave popcorn accessory or unless you use popcorn labeled for use in microwave ovens.
- Some products such as whole eggs and sealed containers—for example, closed jars—will explode and should not be heated in this microwave oven. Such use of the microwave oven could result in injury.
- Do not boil eggs in a microwave oven. Pressure will build up inside egg yolk and will cause it to burst, possibly resulting in injury.
- Operating the microwave with no food inside for more than a minute or two may cause damage to the microwave oven and could start a fire. It increases the heat around the magnetron and can shorten the life of the microwave oven.
- Foods with unbroken outer “skin” such as potatoes, hot dogs, sausages, tomatoes, apples, chicken livers and other giblets, and egg yolks should be pierced to allow steam to escape during cooking.
- Avoid heating baby food in glass jars, even with the lid off. Make sure all infant food is thoroughly cooked. Stir food to distribute the heat evenly. Be careful to prevent scalding when warming formula or breast milk. The container may feel cooler than the milk really is. Always test the milk before feeding the baby.
- Spontaneous boiling—Under certain special circumstances, liquids may start to boil during or shortly after removal from the microwave oven. To prevent burns from splashing liquid, we recommend the following: before removing the container from the microwave oven, allow the container to stand in the microwave oven for 30 to 40 seconds after the microwave oven has shut off. Do not boil liquids in narrow-necked containers such as soft drink bottles, wine flasks and especially narrow-necked coffee cups. Even if the container is opened, excessive steam can build up and cause it to burst or overflow.
- Do not defrost frozen beverages in narrow-necked bottles (especially carbonated beverages). Even if the container is opened, pressure can build up. This can cause the container to burst, possibly resulting in injury.
- Hot foods and steam can cause burns. Be careful when opening any containers of hot food, including popcorn bags, cooking pouches and boxes. To prevent possible injury, direct steam away from hands and face.
- Do not overcook potatoes. They could dehydrate and catch fire, causing damage to your microwave oven.
- Cook meat and poultry thoroughly—meat to at least an INTERNAL temperature of 160°F and poultry to at least an INTERNAL temperature of 180°F. Cooking to these temperatures usually protects against foodborne illness.

# Important Safety Instructions



## ABOUT UTENSILS AND COVERINGS

It is not necessary to buy all new cookware. Many pieces already in your kitchen can be used successfully in your new microwave oven. Make sure the utensil does not touch the interior walls during cooking.

### Use these utensils for safe microwave cooking and reheating:

- glass ceramic (Pyroceram®), such as Corningware®.
- heat-resistant glass (Pyrex®)
- microwave-safe plastics
- paper plates
- microwave-safe pottery, stoneware and porcelain
- browning dish (Do not exceed recommended preheating time. Follow manufacturer's directions.)

### These items can be used for short time reheating of foods that have little fat or sugar in them:

- wood, straw, wicker

## DO NOT USE

- metal pans and bakeware
- dishes with metallic trim
- non-heat-resistant glass
- non-microwave-safe plastics (margarine tubs)
- recycled paper products
- brown paper bags
- food storage bags
- metal twist-ties

Should you wish to check if a dish is safe for microwaving, place the empty dish in the microwave oven and microwave on HIGH for 30 seconds. A dish which becomes very hot should not be used.

### The following coverings are ideal:

- Paper towels are good for covering foods for reheating and absorbing fat while cooking bacon.
- Wax paper can be used for cooking and reheating.
- Plastic wrap that is specially marked for microwave use can be used for cooking and reheating. DO NOT allow plastic wrap to touch food. Vent so steam can escape.
- Lids that are microwave-safe are a good choice because heat is kept near the food to hasten cooking.
- Oven cooking bags are good for large meats or foods that need tenderizing. DO NOT use metal twist ties. Remember to slit bag so steam can escape.

### How to use aluminum foil in your microwave oven:

- Small flat pieces of aluminum foil placed smoothly on the food can be used to shield areas that are either defrosting or cooking too quickly.
- Foil should not come closer than one inch to any surface of the microwave oven.

Should you have questions about utensils or coverings, check a good microwave cookbook or follow recipe suggestions.

**ACCESSORIES** There are many microwave accessories available for purchase. Evaluate carefully before you purchase so that they meet your needs. A microwave-safe thermometer will assist you in

determining correct doneness and assure you that foods have been cooked to safe temperatures. Electrolux is not responsible for any damage to the microwave oven when accessories are used.

## ABOUT CHILDREN AND THE MICROWAVE

Children below the age of 7 should use the microwave oven with a supervising person very near to them. Between the ages of 7 and 12, the supervising person should be in the same room.

At no time should anyone be allowed to lean or swing on the microwave oven door.

Children should be taught all safety precautions: use potholders, remove coverings carefully, pay special attention to packages that crisp food because they may be extra hot.

Don't assume that because a child has mastered one cooking skill he/she can cook everything.

Children need to learn that the microwave oven is not a toy. See page 14 for Child Lock feature.

## ABOUT SAFETY

- Check foods to see that they are cooked to the United States Department of Agriculture's recommended temperatures.

---

160°F - For fresh pork, ground meat, boneless white poultry, fish, seafood, egg dishes and frozen prepared food.

---

165°F - For leftover, ready-to-reheat refrigerated, and deli and carry-out "fresh" food.

---

170°F - White meat of poultry.

---

175°F - Dark meat of poultry.

---

To test for doneness, insert a meat thermometer in a thick or dense area away from fat or bone. NEVER leave the thermometer in the food during cooking, unless it is approved for microwave oven use.

- ALWAYS use potholders to prevent burns when handling utensils that are in contact with hot food. Enough heat from the food can transfer through utensils to cause skin burns.
- Avoid steam burns by directing steam away from the face and hands. Slowly lift the farthest edge of a dish's covering and carefully open popcorn and oven cooking bags away from the face.
- Stay near the microwave oven while it's in use and check cooking progress frequently so that there is no chance of overcooking food.
- NEVER use the cavity for storing cookbooks or other items.
- Select, store and handle food carefully to preserve its high quality and minimize the spread of foodborne bacteria.
- Keep waveguide cover clean. Food residue can cause arcing and/or fires.
- Use care when removing items from the microwave oven so that the utensil, your clothes or accessories do not touch the safety door latches.

# Part Names

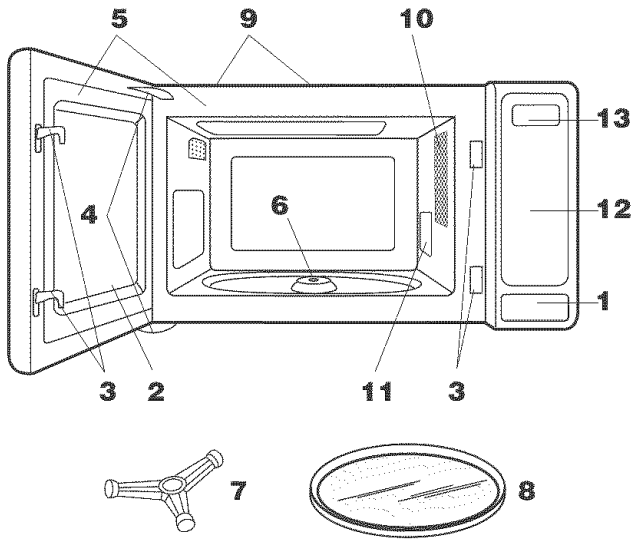

1. One touch door open button  
Push to open door.
2. Microwave Oven door with see-through window
3. Safety door latches  
The Microwave Oven will not operate unless the door is securely closed.
4. Door hinges
5. Door seals and sealing surfaces
6. Turntable motor shaft
7. Removable turntable support  
Carefully place the turntable support in the center of the Microwave Oven floor.
8. Removable turntable  
Place the turntable on the turntable support securely. The turntable will rotate clockwise or counterclockwise. Only remove for cleaning.
9. Ventilation openings (rear)
10. Microwave Oven light  
It will light when Microwave Oven is operating or door is open.
11. Waveguide cover: DO NOT REMOVE.
12. Auto-Touch control panel
13. Time display: 99 minutes, 99 seconds

The 7-digit Interactive Display spells out operating steps and shows cooking hints. When HELP is lighted in the display, touch the **HELP** pad to read a specific hint which may assist you.

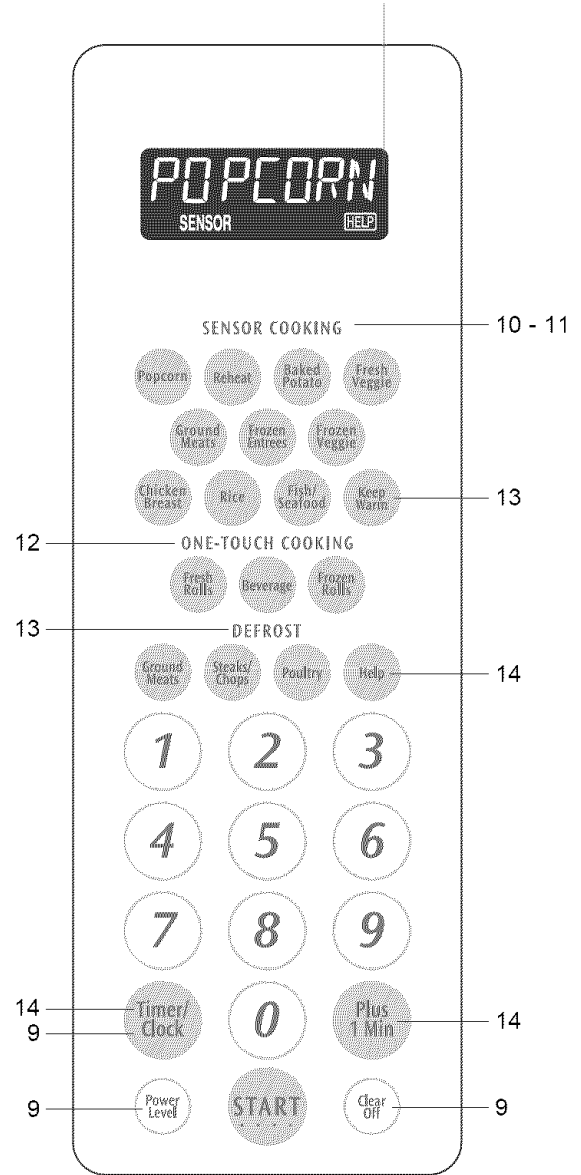

Number next to the control panel illustration indicates page on which there are a feature description and usage information.



# Before Operating



- Before operating your new microwave oven make sure you read and understand this Use and Care manual completely.
- Before the microwave oven can be used, follow these procedures:
  1. Plug in the microwave oven. Close the door. The microwave oven display will show *ENJOY YOUR OVEN PRESS CLEAR AND PRESS CLOCK*.
  2. Touch the **Clear/Off** pad. : will appear.
  3. Set clock.

## TO SET THE CLOCK

- Suppose you want to enter the correct time of day 12:30 (A.M. or P.M.).
  1. Touch **Clock** pad and number 2.
  2. Enter time 1,2,3,0 and press **Clock** pad again.This is a 12 hour clock. If you attempt to enter an incorrect clock time, *ERROR* will appear in the display. Touch the **Clear/Off** pad and re-enter the time.

- If the electrical power supply to your microwave oven should be interrupted, the display will inter-mittently show *ENJOY YOUR OVEN PRESS CLEAR AND PRESS CLOCK* after the power is reinstated. If this occurs during cooking, the program will be erased. The time of day will also be erased. Simply touch **Clear/Off** pad and reset the clock for the correct time of day.

**NOTE:** Your microwave oven can be programmed with the door open except for **START, SENSOR COOKING, ONE-TOUCH COOKING, DEFROST** and **Plus 1 Min.**

## CLEAR/OFF

Touch the **Clear/Off** pad to:

1. Erase if you make a mistake during programming.
2. Cancel timer.
3. Stop the microwave oven temporarily during cooking.
4. Return the time of day to the display.
5. Cancel a program during cooking, touch twice.

# Manual Operation



## TIME COOKING

Your microwave oven can be programmed for 99 minutes 99 seconds (99.99). Always enter the seconds after the minutes, even if they are both zeros.

- Suppose you want to cook for 5 minutes at 100%.
  1. Enter cooking time 5,0,0.
  2. Touch **START** pad.

## TO SET POWER LEVEL

There are eleven preset power levels.

Using lower power levels increases the cooking time, which is recommended for foods such as cheese, milk and long slow cooking of meats. Consult cookbook or recipes for specific recommendations.

TOUCH POWER LEVEL PAD NUMBER OF TIMES FOR DESIRED POWER	APPROXIMATE PERCENTAGE OF POWER	COMMON WORDS FOR POWER LEVELS
POWER LEVEL x 1	100%	High
POWER LEVEL x 2	90%	
POWER LEVEL x 3	80%	
POWER LEVEL x 4	70%	Medium High
POWER LEVEL x 5	60%	
POWER LEVEL x 6	50%	Medium
POWER LEVEL x 7	40%	
POWER LEVEL x 8	30%	Med Low/Defrost
POWER LEVEL x 9	20%	
POWER LEVEL x 10	10%	Low
POWER LEVEL x 11	0%	

- Suppose you want to defrost for 5 minutes at 30%.
  1. Enter defrosting time 5,0,0.
  2. Touch **Power Level** pad eight times or hold down until the desired power level appears.
  3. Touch **START** pad.

When the defrost time is complete, a long tone will sound and *END* will appear in the display.

## MANUAL DEFROST

If the food that you wish to defrost is not listed on the DEFROST CHART or is above or below the limits in the Amount column on the DEFROST CHART, you need to defrost manually.

You can defrost any frozen food, either raw or previously cooked, by using **Power Level** for 30%. Follow the exact 3-step procedure found under TO SET POWER LEVEL. Estimate defrosting time and press **Power Level** pad eight times for 30%.

For either raw or previously cooked frozen food the rule of thumb is approximately 4 minutes per pound. For example, defrost 4 minutes for 1 pound of frozen spaghetti sauce.

Always stop the microwave oven periodically to remove or separate the portions that are defrosted. If food is not defrosted at the end of the estimated defrosting time, program the microwave oven in 1 minute increments on **Power Level** 30% until totally defrosted.

When using plastic containers from the freezer, defrost only long enough to remove from the plastic in order to place in a microwave-safe dish.



# Operating Instructions

## Special Features

### SENSOR COOKING

Electrolux's Sensor is a semi-conductor device that detects the vapor (moisture and humidity) emitted from the food as it heats. The sensor adjusts the cooking times and power level for various foods and quantities.

#### Using Sensor Settings:

1. After microwave oven is plugged in, wait 2 minutes before using SENSOR COOKING.
2. Be sure the exterior of the cooking container and the interior of the microwave oven are dry. Wipe off any moisture with a dry cloth or paper towel.
3. The microwave oven works with foods at normal storage temperature. For example, popcorn would be at room temperature.
4. Any SENSOR COOKING selection can be programmed with More or Less Time Adjustment. See page 14.
5. More or less food than the quantity listed in the chart should be cooked following the guidelines in any microwave cookbook.
6. During the first part of SENSOR COOKING, food name will appear on the display. Do not open the microwave oven door or touch **Clear/Off** during this part of the cooking cycle. The measurement of vapor will be interrupted. If this occurs, an error message will appear. To continue cooking, touch the **Clear/Off** pad and cook manually.  
When the sensor detects the vapor emitted from the food, remainder of cooking time will appear. Door may be opened when remaining cooking time appears on the display. At this time, you may stir or season food, as desired.
7. If the sensor does not detect vapor properly when popping popcorn, the microwave oven will turn off, and the correct time of day will be displayed. If the sensor does not detect vapor properly

when cooking other foods, *ERROR* will be displayed, and the microwave oven will turn off.

8. Check food for temperature after cooking. If additional time is needed, continue to cook manually.
9. SENSOR COOKING can only be entered within 3 minutes after cooking, opening and closing the door or touching the **Clear/Off** pad.
10. Each food has a cooking hint. Touch **Help** pad when the HELP indicator is lighted in the display.

#### Covering Foods:

Some foods work best when covered. Use the cover recommended in the SENSOR COOKING CHART for these foods.

1. Casserole lid.
2. Plastic wrap: Use plastic wrap recommended for microwave cooking. Cover dish loosely; allow approximately 1/2 inch to remain uncovered to allow steam to escape. Plastic wrap should not touch food.
3. Wax paper: Cover dish completely; fold excess wrap under dish to secure. If dish is wider than paper, overlap two pieces at least one inch to cover.

Be careful when removing any covering to allow steam to escape away from you.

#### EXAMPLE:

You can cook many foods by touching just one pad. You don't need to calculate cooking time or power level.

- Suppose you want to reheat canned chili.

Touch **Reheat** pad.

When sensor detects the vapor emitted from the food, remainder of reheating time will appear.

### SENSOR COOKING CHART

FOOD	AMOUNT	PROCEDURE
Popcorn	1 package 1.5 - 3.5 oz bag	Use only popcorn packaged for microwave oven use. Try several brands to decide which you like. Do not try to pop unpopped kernels. Touch <b>Popcorn</b> pad.
Reheat	4 - 36 oz	Place in dish or casserole slightly larger than amount to be reheated. Flatten, if possible. Cover with lid, plastic wrap or wax paper. Use covers such as plastic wrap or lids with larger quantities of more dense foods such as stews. After reheating, stir well, if possible. Re-cover and allow to stand 2 to 3 minutes. Foods should be very hot. If not, continue to heat with variable power and time.
Baked Potato	1 - 8 med.	Pierce. Place on paper-towel-lined turntable. After cooking, remove from microwave oven, wrap in aluminum foil and let stand 5 to 10 minutes.
Fresh Veggie: Soft		Wash and place in casserole. Add no water if vegetables have just been washed. Cover with lid for tender vegetables. Use plastic wrap for tender-crisp vegetables. Touch <b>Fresh Veggie</b> pad. After cooking, stir, if possible. Let stand, covered, for 2 to 5 minutes.
Broccoli	.25 - 2.0 lb	
Brussels sprouts	.25 - 2.0 lb	
Cabbage	.25 - 2.0 lb	
Cauliflower (flowerets)	.25 - 2.0 lb	
Cauliflower (whole)	1 med.	
Spinach	.25 - 1.0 lb	
Zucchini	.25 - 2.0 lb	
Baked apples	2 - 4 med.	

# Operating Instructions

## Special Features



### SENSOR COOKING CHART (CONT.)

FOOD	AMOUNT	PROCEDURE															
Fresh Veggie: Hard Carrots, sliced Corn on the cob Green beans Winter squash: diced halves	.25 - 1.5 lb 2 - 4 .25 - 1.5 lb .25 - 1.5 lb 1 - 2	Place in casserole. Add 1-4 tbsp water. Cover with lid for tender vegetables. Use plastic wrap cover for tender-crisp vegetables. Touch <b>Fresh Veggie</b> pad twice. After cooking, stir, if possible. Let stand, covered, for 2 to 5 minutes.															
Ground Meats	.25 - 2.0 lb	Use this setting to cook ground beef or turkey as patties or in a casserole to be added to other ingredients. Place patties on a microwave-safe rack and cover with wax paper. Place ground meat in a casserole and cover with wax paper or plastic wrap. When microwave oven stops, turn patties over or stir meat in casserole to break up large pieces. Re-cover and touch <b>START</b> . After cooking, let stand, covered, for 2 to 3 minutes.															
Frozen Entrees	6 - 17 oz	Use this pad for frozen convenience foods. It will give satisfactory results for most brands. You may wish to try several and choose your favorite. Remove package from outer wrapping and follow package directions for covering. After cooking, let stand, covered, for 1-3 minutes.															
Frozen Veggie	.25 - 1.5 lb	Add no water. Cover with lid or plastic wrap. After cooking, stir and let stand, covered, for 3 minutes.															
Chicken Breast	.5 - 2.0 lb	Cover with vented plastic wrap. Touch <b>Chicken Breast</b> pad. When microwave oven stops, turn over. Shield with small, flat pieces of aluminum foil any areas that are cooking too rapidly. Re-cover and touch <b>START</b> . After cooking, let stand, covered 3-5 minutes. Chicken should be 160°F.															
Rice	.5 - 2.0 cups	Place rice into a deep casserole and add double quantity of water. Cover with lid or plastic wrap. After cooking, stir, cover and let stand 3 to 5 minutes or until all liquid has been absorbed. <table style="margin-left: auto; margin-right: auto; border-collapse: collapse;"> <thead> <tr> <th style="text-align: left;">Rice</th> <th style="text-align: left;">Water</th> <th style="text-align: left;">Size of casserole</th> </tr> </thead> <tbody> <tr> <td>.5 cup</td> <td>1 cup</td> <td>1.5 quart</td> </tr> <tr> <td>1 cup</td> <td>2 cups</td> <td>2 quart</td> </tr> <tr> <td>1.5 cups</td> <td>3 cups</td> <td>2.5 or 3 quart</td> </tr> <tr> <td>2 cups</td> <td>4 cups</td> <td>3 quart or larger</td> </tr> </tbody> </table>	Rice	Water	Size of casserole	.5 cup	1 cup	1.5 quart	1 cup	2 cups	2 quart	1.5 cups	3 cups	2.5 or 3 quart	2 cups	4 cups	3 quart or larger
Rice	Water	Size of casserole															
.5 cup	1 cup	1.5 quart															
1 cup	2 cups	2 quart															
1.5 cups	3 cups	2.5 or 3 quart															
2 cups	4 cups	3 quart or larger															
Fish/Seafood	.25 - 2.0 lb	Arrange in ring around shallow glass dish (roll fillet with edges underneath). Cover with vented plastic wrap. After cooking, let stand, covered for 3 minutes.															



# Operating Instructions

## Special Features

### ONE-TOUCH COOKING

ONE-TOUCH COOKING allows you to cook or reheat many of your favorite foods by touching just one pad.

- Suppose you want to heat 2 fresh rolls or muffins.

Touch **Fresh Rolls** pad 2 times. The microwave oven starts automatically.

#### NOTE:

1. To increase quantity, touch chosen pad until number in display is same as desired quantity to cook. Ex: touch **Beverage** two times for one cup. More or less food than the quantity listed in the

chart should be heated following the guidelines in any microwave cookbook.

2. To use any ONE-TOUCH COOKING pad, touch within 3 minutes after cooking, opening and closing the door or touching the **Clear/Off** pad.
3. ONE-TOUCH COOKING can be programmed with More or Less Time Adjustment. See page 14.
4. The final result will vary according to the food condition (e.g. initial temperature, shape, quality). Check food for temperature after heating. If additional time is needed, continue to heat manually.

### ONE-TOUCH COOKING CHART

FOOD	AMOUNT	PROCEDURE
Fresh Rolls	1 - 10 pieces	Use this pad to warm rolls, muffins, biscuits, bagels etc. Large items should be considered as 2 or 3 regular size. Arrange on plate; cover with paper towel. For refrigerated rolls or muffins, it may be necessary to double the entered amount to ensure the proper serving temperature. For example, enter quantity of 2 for 1 refrigerated muffin.
Beverage	.5 - 2.0 cups	This setting is good for restoring cooled beverage to a better drinking temperature. Stir liquid briskly before and after heating to avoid "eruption". Touch <b>Beverage</b> pad. <b>Press the pad for amount</b> Once .5 cup Twice 1 cup 3 times 1.5 cups 4 times 2 cups
Frozen Rolls	1 - 10 pieces	Use this pad to warm rolls, muffins, biscuits, bagels etc. Large items should be considered as 2 or 3 regular size. Arrange on plate; cover with paper towel.

# Operating Instructions

## Special Features



### DEFROST

DEFROST automatically defrosts all the foods shown in the DEFROST CHART.

Round the weight to the nearest half pound. (Ex: if the steak's actual weight is 2.2 lb round to 2.0 lb If the steak's weight is 2.4 lb round to 2.5 lb.)

To enter weight, touch the desired DEFROST pad for a 0.5 lb increase per touch. (Ex: touch four times for 2.0 lb.)

• Suppose you want to defrost a 2.0 pound steak.

1. Quickly touch **Steak/Chops** pad 4 times for 2.0 lb. The microwave oven will start automatically.

The microwave oven will stop and directions will be displayed. Follow the indicated message.

2. After the 1st stage, open the door, turn steak over and shield any warm portions. Close the door. Touch **START** pad.
3. After the 2nd stage, open the door and shield any warm portions. Close the door. Touch **START** pad.

After defrost cycle ends, cover and let stand as indicated in chart.

### NOTE:

1. If you attempt to enter more or less than the allowed weight as indicated in chart, **ERROR** will appear in the display.
2. DEFROST can be programmed with More or Less Time Adjustment. See page 14.
3. To defrost other foods or foods above or below the weights allowed on DEFROST CHART use time and 30% power. See Manual Defrost on page 9.
4. You may choose to enter the weight in tenths of pounds. This procedure may be easier with larger weights, such as 3 pounds, because it requires fewer touches. To program, touch desired DEFROST pad and enter weight by touching the number pads. Ex: touch **Steaks/Chops** then 3 and 0 for a weight of three pounds or touch **Steaks/Chops** then 2 and 2 for a weight of 2.2 lb.
5. To use any DEFROST pad, touch within 3 minutes after cooking, opening and closing the door or touching the **Clear/Off** pad.

### DEFROST CHART

FOOD	AMOUNT	PROCEDURE
Ground Meats	.5 - 2.0 lb	Remove any thawed pieces after each stage. Let stand, covered, for 5 to 10 minutes.
Steaks/Chops	.5 - 3.0 lb	After each stage, rearrange and if there are warm or thawed portions, shield with small flat pieces of aluminum foil. Remove any meat or fish that is nearly defrosted. Let stand, covered, for 10 to 20 minutes.
Poultry (Pieces)	.5 - 3.0 lb	After each stage, if there are warm or thawed portions, rearrange or remove. Let stand, covered, for 10 to 20 minutes.

### KEEP WARM

Keep Warm allows you to keep food warm up to 30 minutes.

#### DIRECT USE

• Suppose you want to keep a cup of soup warm for 15 minutes.

1. Touch **Keep Warm** pad.
2. Enter time 1,5,0,0.
3. Touch **START** pad.

The microwave oven will start. The display will show 15.00 and count down. **KEEP WARM** will be displayed during the count down.

You can program Keep Warm with manual cooking to keep food warm continuously after cooking.

### WITH MANUAL COOKING

• Suppose you want to cook a cup of soup for 2 minutes at 70% and keep the soup warm for 15 minutes.

1. Enter cooking time 2,0,0.
2. Touch **Power Level** pad 4 times for 70% power.
3. Touch **Keep Warm** pad.
4. Enter time 1,5,0,0.
5. Touch **START** pad.

The operation will start. When the cooking time is complete, a long tone will sound and **Keep Warm** will start. The display will count down for 15 minutes and **KEEP WARM** will be displayed during the count down.

**NOTE:** Keep Warm cannot be programmed with SPECIAL FEATURES.



# Operating Instructions

## Other Convenient Features

### HELP

Help provides 4 features that make using your microwave oven easy because specific instructions are provided in the interactive display.

#### 1. Child Lock

The Child Lock prevents unwanted microwave oven operation such as by small children. The microwave oven can be set so that the control panel is deactivated or locked. To set, touch **Help**, the number 1 and then touch the **START** pad. Should a pad be touched, *CHILD LOCK ON* will appear in the display. To cancel, touch **Help** and **Clear/Off** pad.

#### 2. Audible Signal Elimination

If you wish to have the microwave oven operate with no audible signals, touch **Help**, the number 2 and **Clear/Off**. To cancel and restore the audible signal, touch **Help**, the number 2 and **START**.

#### 3. Auto Start

If you wish to program your microwave oven to begin cooking automatically at a designated time of day, follow this procedure:

- Suppose you want to start cooking a stew for 20 minutes on 50% at 4:30. Before setting, check to make sure the clock is showing the correct time of day.

1. Touch **Help** pad.
2. Touch number 3.
3. Enter number 4,3,0 for start time.
4. Touch **Timer/Clock** pad.
5. Enter cooking program by touching number 2,0,0,0, **Power Level** pad 6 times.
6. Touch **START** pad.

#### NOTE:

1. Auto Start can be used for manual cooking if clock is set.
2. If the microwave oven door is opened after programming Auto Start, it is necessary to touch the **START** pad for Auto Start time to appear in the readout so that the microwave oven will automatically begin programmed cooking at the chosen Auto Start time.
3. Be sure to choose foods that can be left in the microwave oven safely until the Auto Start time. Acorn or butternut squash are often a good choice.
4. If you wish to know the time of day, simply touch the **Timer/Clock** pad. As long as your finger is touching the **Timer/Clock** pad, the time of day will be displayed.

#### 4. Language /Weight Selection

The microwave oven comes set for English and U.S. Customary Unit-pounds. To change, touch **Help** and the number 4. Continue to touch the number 4 until your choice is selected from the table below. Then, touch **START**.

- Touch number 4 once for English/LB.
- Touch number 4 twice for English/KG.
- Touch number 4 three times for Spanish/LB.
- Touch number 4 four times for Spanish/KG.
- Touch number 4 five times for French/LB.
- Touch number 4 six times for French/KG.

### HELP (In display)

Whenever HELP is lighted in the Interactive Display, touch **Help** to read cooking and operating hints.

### MULTIPLE SEQUENCE COOKING

Your microwave oven can be programmed for up to 4 automatic cooking sequences, switching from one power level setting to another automatically.

Sometimes cooking directions tell you to start on one power level and then change to a different power level. Your microwave oven can do this automatically.

- Suppose you want to cook roast beef for 5 minutes at 100% and then continue to cook for 30 minutes at 50%.

1. First enter cooking time. Then touch **Power Level** pad once for 100% power.
2. Enter second cooking time. Touch **Power Level** pad 6 times for 50% power.
3. Touch **START** pad.

#### NOTE:

1. If you wish to know power level, simply touch the **Power Level** pad. As long as your finger is touching the **Power Level** pad, the power level will be displayed.
2. If 100% is selected as the final sequence, it is not necessary to touch the **Power Level** pad.

### PLUS 1 MIN

Plus 1 Min allows you to cook for a minute at 100% by simply touching the **Plus 1 Min** pad. You can also extend cooking time in multiples of 1 minute by repeatedly touching the **Plus 1 Min** pad during manual cooking.

#### NOTE:

1. To use **Plus 1 Min**, touch pad within 3 minutes after cooking, closing the door, touching the **Clear/Off** pad or during cooking.
2. **Plus 1 Min** cannot be used with Special Features.

### DEMONSTRATION MODE

To demonstrate, touch **Timer/Clock**, the number 0 and touch **START** and hold for 3 seconds. *DEMO ON* will appear in the display. Cooking operations and specific special features can now be demonstrated with no power in the microwave oven. For example, touch **Clear/Off** and touch **Plus 1 Min**, and the display will show *1.00* and count down quickly to *END*.

To cancel, touch **Timer/Clock**, then the number 0 and **Clear/Off**. If easier, unplug the microwave oven from the electrical outlet, replug and set the clock.

### MORE OR LESS TIME ADJUSTMENT

Should you discover that you like any of the SENSOR COOKING, DEFROST or ONE-TOUCH COOKING settings slightly **more** done, touch the **Power Level** pad once after touching your choice of pads. The display will show *MORE*. For slightly **less** done, touch the **Power Level** pad twice after touching your choice of pads. The display will show *LESS*. The **Power Level** pad must be touched within 1 second of touching your choice of pads.

### TIMER

- Suppose you want to time a 3 minute long distance phone call.

1. Touch **Timer/Clock** pad and number 1.
2. Touch 3,0,0 to enter time.
3. Touch **Timer/Clock** pad. The Timer will count down.

# Cleaning and Care



## EXTERIOR

The outside surface is precoated steel and plastic. Clean the outside with mild soap and water; rinse and dry with a soft cloth. Do not use any type of household or abrasive cleaner.

## DOOR

Wipe the window on both sides with a damp cloth to remove any spills or splatters. Metal parts will be easier to maintain if wiped frequently with a damp cloth. Cleaners which are marked specifically for use with stainless steel may be used. Follow package directions exactly. Avoid the use of any harsh cleaner or one not marked for stainless steel use as they may stain, streak or dull the door surface.

## TOUCH CONTROL PANEL

Care should be taken in cleaning the touch control panel. If the control panel becomes soiled, open the microwave oven door before cleaning. Wipe the panel with a cloth dampened slightly with water only. Dry with a soft cloth. Do not scrub or use any sort of chemical cleaners. Close door and touch **Clear/Off**.

## INTERIOR

Cleaning is easy because little heat is generated to the interior surfaces; therefore, there is no baking and setting of spills or spattering. To clean the interior surfaces, wipe with a soft cloth and warm water. **DO NOT USE ABRASIVE OR HARSH CLEANERS OR SCOURING PADS.** For heavier soil, use baking soda or a mild soap; rinse thoroughly with hot water.

## WAVEGUIDE COVER

The waveguide cover is located on the ceiling in the microwave oven cavity. It is made from mica so requires special care. Keep the waveguide cover clean to assure good microwave oven performance. Carefully wipe with a damp cloth any food splatters from the surface of the cover immediately after they occur. Built-up splashes may overheat and cause smoke or possibly catch fire. **DO NOT REMOVE THE WAVEGUIDE COVER.**

## ODOR REMOVAL

Occasionally, a cooking odor may remain in the microwave oven. To remove, combine 1 cup water, grated peel and juice of 1 lemon and several whole cloves in a 2-cup glass measuring cup. Boil for several minutes using 100% power. Allow to set in microwave oven until cool. Wipe interior with a soft cloth.

## TURNTABLE/TURNTABLE SUPPORT

The turntable and turntable support can be removed for easy cleaning. Wash them in mild, sudsy water; for stubborn stains use a mild cleanser and non abrasive scouring sponge. They are also dishwasher-proof. Use upper rack of dishwasher. The turntable motor shaft is not sealed, so excess water or spills should be wiped up immediately.

# Service Call Check



Please check the following before calling for service:

Place one cup of water in a glass measuring cup in the microwave oven and close the door securely. Operate the microwave oven for one minute at HIGH 100%.

- |   |           |          |
|---|-----------|----------|
| <b>A</b> Does the microwave oven light come on?   | YES _____ | NO _____ |
| <b>B</b> Does the cooling fan work? (Put your hand over the rear ventilation openings.)           | YES _____ | NO _____ |
| <b>C</b> Does the turntable rotate? (It is normal for the turntable to turn in either direction.) | YES _____ | NO _____ |
| <b>D</b> Is the water in the microwave oven warm?   | YES _____ | NO _____ |

If "NO" is the answer to any of the above questions, please check electrical outlet, fuse and/or circuit breaker. If they are functioning properly, **CONTACT YOUR NEAREST ELECTROLUX AUTHORIZED SERVICER.**

A microwave oven should never be serviced by a "do-it-yourself" repair person.

**NOTE:** If time appearing in the display is counting down very rapidly, check Demonstration Mode on page 14 and cancel.

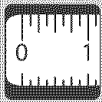

# Specifications

## GLMB209DB/DS/DQ, PLMB209DC, CPLMB209DC

AC Line Voltage:	UL Rating - Single phase 120V, 60Hz, AC only CUL Rating - Single phase 120V, 60Hz, AC only
AC Power Required:	UL Rating - 1700W 14.3 amps. CUL Rating - 1500W 13.0 amps.
Output Power*:	UL - GLMB209DB/DS/DQ, PLMB209DC: 1200W CUL - CPLMB209DC: 1100W
Frequency:	2450 MHz
Outside Dimensions:	24"(W) x 13 3/8"(H) x 19 1/8"(D)
Cavity Dimensions:	17 3/8"(W) x 10 1/2"(H) x 18 5/8"(D)
Microwave oven Capacity**:	2.0 Cu.Ft.
Cooking Uniformity:	Turntable
Weight:	Approx. 46 LB

\* The International Electrotechnical Commission's standardized method for measuring output wattage. This test method is widely recognized.

\*\* Internal capacity is calculated by measuring maximum width, depth and height. Actual capacity for holding food is less.

In compliance with standards set by:

**FCC** – Federal Communications Commission Authorized.

**DHHS** – Complies with Department of Health and Human Services (DHHS) rule, CFR, Title 21, Chapter I, Subchapter J.

**NHW** – Department of National Health and Welfare of Canada.

 – This symbol on the nameplate means the product is listed by Underwriters Laboratories, Inc.

 – This symbol on the nameplate means the product is listed by Underwriters Laboratories, Inc. for use in USA or Canada.

This microwave oven is listed by the Canadian Standard Association as certified (CPLMB209DC).



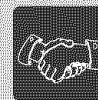

# LIMITED WARRANTY

Your microwave is protected by this warranty

	WARRANTY PERIOD	THROUGH OUR AUTHORIZED SERVICERS, WE WILL:	THE CONSUMER WILL BE RESPONSIBLE FOR:
<b>FULL ONE-YEAR WARRANTY</b>	One year from original purchase date.	Pay all costs for repairing or replacing any parts of this appliance which prove to be defective in materials or workmanship.	Costs of service calls that are listed under <b>NORMAL RESPONSIBILITIES OF THE CONSUMER.*</b>
<b>LIMITED 2ND YEAR WARRANTY (Microwave Oven)</b>	Two years from original purchase date.	Repair or replace any part of the microwave oven which proves to be defective in materials or workmanship.	Cost of shipping the replacement part to the nearest authorized servicer; and all labor and service charges.
<b>LIMITED 2nd - 10th YEAR WARRANTY (Magnetron Tube)</b>	Second through tenth years from original purchase date.	Provide a replacement for any magnetron tube which proves to be defective in workmanship or material.	Cost of shipping the replacement part to the nearest authorized servicer; and all labor and service charges.
<b>LIMITED WARRANTY (Applicable to the State of Alaska)</b>	Time periods listed above.	All of the provisions of the full and limited warranties above and the exclusions listed below apply.	Cost of the technician's travel to the home and any costs for pick up and delivery of the appliance required because of service.

In the U.S.A., your appliance is warranted by Electrolux Home Products, Inc. In Canada, your appliance is warranted by Electrolux Canada Corp. We authorize no person to change or to add to any of our obligations under this warranty. Our obligations for service and parts under this warranty must be performed by us or an authorized servicer.

### \*NORMAL RESPONSIBILITIES OF THE CONSUMER

**This warranty applies only to products in ordinary household use, and the consumer is responsible for the items listed below:**

1. Proper use of the appliance in accordance with instructions provided with the product.
2. Proper installation by an authorized servicer in accordance with instructions provided with the appliance and in accordance with all local plumbing, electrical and/or gas codes.
3. Proper connection to a grounded power supply of sufficient voltage, replacement of blown fuses, repair of loose connections or defects in house wiring.
4. Expenses for making the appliance accessible for servicing, such as removal of trim, cupboards, shelves, etc., which are not a part of the appliance when it was shipped from the factory.
5. Damages to finish after installation.
6. Replacement of light bulbs and/or fluorescent tubes (on models with these features).

### EXCLUSIONS

**This warranty does not cover the following:**

1. CONSEQUENTIAL OR INCIDENTAL DAMAGES SUCH AS PROPERTY DAMAGE AND INCIDENTAL EXPENSES RESULTING FROM ANY BREACH OF THIS WRITTEN OR ANY IMPLIED WARRANTY.  
*Note: Some states do not allow the exclusion or limitation of incidental or consequential damages, so this limitation or exclusion may not apply to you.*
2. Service calls which do not involve malfunction or defects in workmanship or material, or for appliances not in ordinary household use. The consumer shall pay for such service calls.
3. Damages caused by services performed by servicers other than Electrolux Home Products, Inc., Electrolux Canada Corp., or their authorized servicers; use of parts other than genuine Electrolux parts; obtained from persons other than such servicers; or external causes such as abuse, misuse, inadequate power supply or acts of God.
4. Products with original serial numbers that have been removed or altered and cannot be readily determined.

### IF YOU NEED SERVICE

Keep your bill of sale, delivery slip, or some other appropriate payment record. The date on the bill establishes the warranty period should service be required. If service is performed, it is in your best interest to obtain and keep all receipts. This written warranty gives you specific legal rights. You may also have other rights that vary from state to state. Service under this warranty must be obtained by contacting Electrolux Home Products, Inc. or Electrolux Canada Corp.

This warranty only applies in the 50 states of the U.S.A., Puerto Rico, and Canada. Product features or specifications as described or illustrated are subject to change without notice. All warranties are made by Electrolux Home Products, Inc. or Electrolux Canada Corp.

2004\_02

**USA**  
**800•944•9044**  
 Electrolux Home Products, Inc.  
 P.O. Box 212378  
 Augusta, GA 30917

**Canada**  
**866•294•9911 (English or French)**  
 Electrolux Canada Corp.  
 6150 McLaughlin Road  
 Mississauga, Ontario, Canada L5R 4C2