

GAS DOUBLE OVEN RANGE

Use & Care Guide

For questions about features, operation/performance,
parts, accessories or service, call: **1-800-253-1301**.

or visit our website at...
www.whirlpool.com

| | |
|------------------------|---|
| Table of Contents..... | 2 |
|------------------------|---|

Models
GGG388LX, GGG390LX

TABLE OF CONTENTS

| | | | |
|---------------------------------------|-----------|--|-----------|
| RANGE SAFETY | 2 | Positioning Racks and Bakeware | 11 |
| The Anti-Tip Bracket | 4 | Bakeware..... | 12 |
| COOKTOP USE | 5 | Meat Thermometer..... | 12 |
| Cooktop Controls..... | 5 | Oven Vents | 12 |
| Power Failure..... | 5 | Baking..... | 12 |
| Sealed Surface Burners | 6 | Broiling..... | 13 |
| Home Canning | 6 | Convection Cooking - Lower Oven Only | 14 |
| Cookware | 7 | Hold Warm Feature | 15 |
| ELECTRONIC OVEN CONTROLS | 7 | Automatic Shutoff/Sabbath Mode | 16 |
| Display | 8 | Start Time | 16 |
| Cancel | 8 | RANGE CARE | 17 |
| Oven Lights | 8 | Self-Cleaning Cycle..... | 17 |
| Kitchen Timer | 8 | General Cleaning | 18 |
| Settings | 8 | Oven Light | 19 |
| Oven Temperature Control | 10 | Oven Door | 19 |
| Control Lockout..... | 10 | TROUBLESHOOTING | 20 |
| OVEN USE | 10 | ASSISTANCE OR SERVICE | 22 |
| Aluminum Foil..... | 11 | Accessories | 22 |
| | | WARRANTY | 23 |

RANGE SAFETY

Your safety and the safety of others are very important.

We have provided many important safety messages in this manual and on your appliance. Always read and obey all safety messages.



This is the safety alert symbol.

This symbol alerts you to potential hazards that can kill or hurt you and others.

All safety messages will follow the safety alert symbol and either the word "DANGER" or "WARNING."

These words mean:

⚠ DANGER

You can be killed or seriously injured if you don't immediately follow instructions.

⚠ WARNING

You can be killed or seriously injured if you don't follow instructions.

All safety messages will tell you what the potential hazard is, tell you how to reduce the chance of injury, and tell you what can happen if the instructions are not followed.

WARNING: If the information in this manual is not followed exactly, a fire or explosion may result causing property damage, personal injury or death.

- Do not store or use gasoline or other flammable vapors and liquids in the vicinity of this or any other appliance.
- **WHAT TO DO IF YOU SMELL GAS:**
 - Do not try to light any appliance.
 - Do not touch any electrical switch.
 - Do not use any phone in your building.
 - Immediately call your gas supplier from a neighbor's phone. Follow the gas supplier's instructions.
 - If you cannot reach your gas supplier, call the fire department.
- Installation and service must be performed by a qualified installer, service agency or the gas supplier.

WARNING: Gas leaks cannot always be detected by smell.

Gas suppliers recommend that you use a gas detector approved by UL or CSA.

For more information, contact your gas supplier.

If a gas leak is detected, follow the "What to do if you smell gas" instructions.

State of California Proposition 65 Warnings:

WARNING: This product contains a chemical known to the State of California to cause cancer.

WARNING: This product contains a chemical known to the State of California to cause birth defects or other reproductive harm.

The Anti-Tip Bracket

The range will not tip during normal use. However, the range can tip if you apply too much force or weight to the open door without the anti-tip bracket fastened down properly.



⚠ WARNING

Tip Over Hazard

A child or adult can tip the range and be killed.

Connect anti-tip bracket to rear range foot.

Reconnect the anti-tip bracket, if the range is moved.

See the installation instructions for details.

Failure to follow these instructions can result in death or serious burns to children and adults.

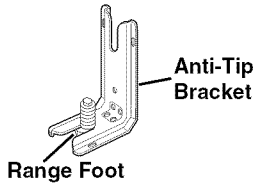

Making sure the anti-tip bracket is installed:

- Slide range forward.
- Look for the anti-tip bracket securely attached to floor or wall.
- Slide range back so rear range foot is under anti-tip bracket.

IMPORTANT SAFETY INSTRUCTIONS

WARNING: To reduce the risk of fire, electrical shock, injury to persons, or damage when using the range, follow basic precautions, including the following:

- **WARNING:** TO REDUCE THE RISK OF TIPPING OF THE RANGE, THE RANGE MUST BE SECURED BY PROPERLY INSTALLED ANTI-TIP DEVICES. TO CHECK IF THE DEVICES ARE INSTALLED PROPERLY, SLIDE RANGE FORWARD, LOOK FOR ANTI-TIP BRACKET SECURELY ATTACHED TO FLOOR, AND SLIDE RANGE BACK SO REAR RANGE FOOT IS UNDER ANTI-TIP BRACKET.
- **WARNING:** NEVER use this appliance as a space heater to heat or warm the room. Doing so may result in carbon monoxide poisoning and overheating of the oven.
- **WARNING:** NEVER cover any slots, holes or passages in the oven bottom or cover an entire rack with materials such as aluminum foil. Doing so blocks air flow through the oven and may cause carbon monoxide poisoning. Aluminum foil linings may also trap heat, causing a fire hazard.
- **CAUTION:** Do not store items of interest to children in cabinets above a range or on the backguard of a range – children climbing on the range to reach items could be seriously injured.
- Proper Installation – The range, when installed, must be electrically grounded in accordance with local codes or, in the absence of local codes, with the *National Electrical Code, ANSI/NFPA 70*. In Canada, the range must be electrically grounded in accordance with Canadian Electrical Code. Be sure the range is properly installed and grounded by a qualified technician.

- This range is equipped with a three-prong grounding plug for your protection against shock hazard and should be plugged directly into a properly grounded receptacle. Do not cut or remove the grounding prong from this plug.
- Disconnect power before servicing.
- Injuries may result from the misuse of appliance doors or drawers such as stepping, leaning, or sitting on the doors or drawers.
- Maintenance – Keep range area clear and free from combustible materials, gasoline, and other flammable vapors and liquids.
- Storage in or on the Range – Flammable materials should not be stored in an oven or near surface units.
- Top burner flame size should be adjusted so it does not extend beyond the edge of the cooking utensil.

For self-cleaning ranges –

- Before Self-Cleaning the Oven – Remove broiler pan and other utensils. Wipe off all excessive spillage before initiating the cleaning cycle.

SAVE THESE INSTRUCTIONS

COOKTOP USE

This manual covers different models. The range you have purchased may have some or all of the items listed. The locations and appearances of the items shown here may not match those of your model.

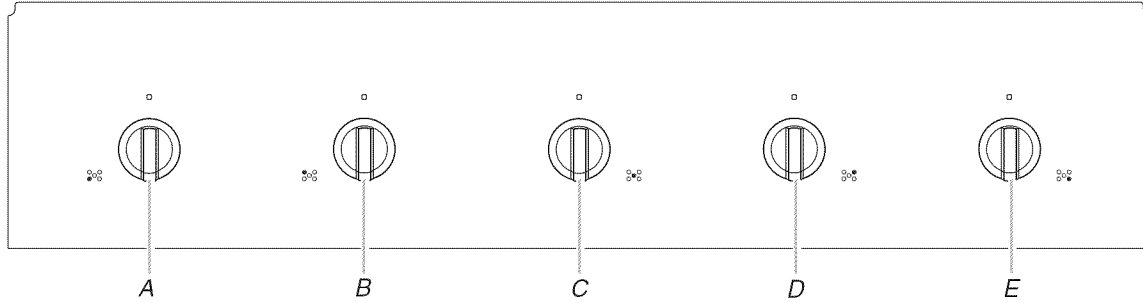

A. Left front control knob
B. Left rear control knob

C. Center burner (on some models)

D. Right rear control knob
E. Right front control knob

Cooktop Controls

WARNING



Fire Hazard

Do not let the burner flame extend beyond the edge of the pan.

Turn off all controls when not cooking.

Failure to follow these instructions can result in death or fire.

IMPORTANT: Your range is factory-set for use with Natural gas. If you wish to use LP gas, an LP Gas Conversion Kit is included with your new range. See the "Gas Conversions" section of the Installation Instructions for details on making this conversion.

Electric igniters automatically light the surface burners when control knobs are turned to LIGHT.

The large burners (16,000, 14,000 and 12,500 Btu/h [British Thermal Units]) provide the highest heat setting, and are ideal for cooking large quantities of food or liquid, using large pots and pans. The small burners (9,200 and 5,000 Btu/h) allow more accurate simmer control at the lowest setting, and are ideal for cooking smaller quantities of food, using smaller pots and pans.

Before setting a control knob, place filled cookware on the grate. Do not operate a burner while using empty cookware or without any cookware on the grate.

NOTE: Visually check that the burner has lit. If the burner does not ignite, listen for a clicking sound. If you do not hear the igniter click, turn the burner off. Check for a tripped circuit breaker or blown household fuse.

Check that the control knob is pressed completely down on the valve shaft. If the spark igniter still does not operate, call a trained repair specialist.

To Set:

1. Push in and turn knob counterclockwise to LIGHT. All the surface burners will click. Only the burner with the control knob turned to LIGHT will produce a flame.
2. Turn knob anywhere between HI and LO. Use the following chart as a guide when setting heat levels.

| SETTING | RECOMMENDED USE |
|---------------------|---|
| LIGHT | <ul style="list-style-type: none"> ■ Light the burner. |
| HI | <ul style="list-style-type: none"> ■ Start food cooking. ■ Bring liquid to a boil. |
| MED (Medium) | <ul style="list-style-type: none"> ■ Hold a rapid boil. ■ Quickly brown or sear food. ■ Fry or sauté foods. ■ Cook soups, sauces and gravies. ■ Stew or steam foods. |
| LO | <ul style="list-style-type: none"> ■ Keep food warm. ■ Simmer. |

REMEMBER: When range is in use or (on some models) during the Self-Cleaning cycle, the entire cooktop area may become hot.

Sealed Surface Burners

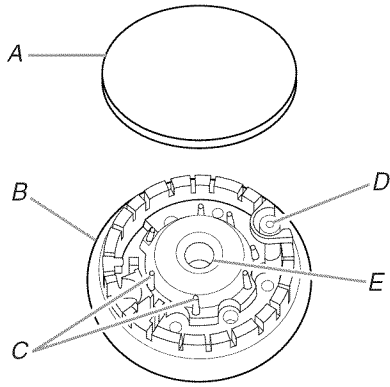

- A. Burner cap
- B. Burner base
- C. Alignment pins
- D. Igniter
- E. Gas tube opening

IMPORTANT: Do not obstruct the flow of combustion and ventilation air around the burner grate edges.

Burner cap: Always keep the burner cap in place when using a surface burner. A clean burner cap will help avoid poor ignition and uneven flames. Always clean the burner cap after a spillover and routinely remove and clean the caps according to the “General Cleaning” section.

Gas tube opening: Gas must flow freely throughout the gas tube opening for the burner to light properly. Keep this area free of soil and do not allow spills, food, cleaning agents or any other material to enter the gas tube opening. Keep spillovers out of the gas tube by always using a burner cap.

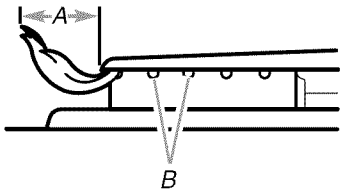

- A. 1-1½" (25-38 mm)
- B. Burner ports

Burner ports: Check burner flames occasionally for proper size and shape as shown above. A good flame is blue in color, not yellow. Keep this area free of soil and do not allow spills, food, cleaning agents or any other material to enter the burner ports.

To Clean:

IMPORTANT: Before cleaning, make sure all controls are off and the oven and cooktop are cool. Do not use oven cleaners, bleach or rust removers.

1. Remove the burner cap from the burner base and clean according to “General Cleaning” section.
2. Clean the gas tube opening with a damp cloth.
3. Clean clogged burner ports with a straight pin as shown. Do not enlarge or distort the port. Do not use a wooden toothpick. If the burner needs to be adjusted, contact a trained repair specialist.

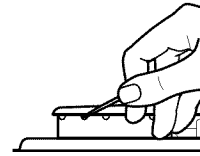

4. Replace the burner cap, making sure the alignment pins are properly aligned with the burner cap.

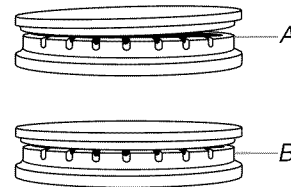

- A. Incorrect
- B. Correct

5. Turn on the burner. If the burner does not light, check cap alignment. If the burner still does not light, do not service the sealed burner yourself. Contact a trained repair specialist.

Home Canning

When canning for long periods, alternate the use of surface burners between batches. This allows time for the most recently used areas to cool.

- Center the canner on the grate.
- Do not place canner on 2 surface burners at the same time.
- For more information, contact your local agricultural department. Companies that manufacture home canning products can also offer assistance.

Cookware

IMPORTANT: Do not leave empty cookware on a hot surface cooking area, element or surface burner.

Ideal cookware should have a flat bottom, straight sides and a well-fitting lid, and the material should be of medium-to-heavy thickness.

Rough finishes may scratch the cooktop or grates. Aluminum and copper may be used as a core or base in cookware. However, when used as a base they can leave permanent marks on the cooktop or grates.

Cookware material is a factor in how quickly and evenly heat is transferred, which affects cooking results. A nonstick finish has the same characteristics as its base material. For example, aluminum cookware with a nonstick finish will take on the properties of aluminum.

Cookware with nonstick surfaces should not be used under the broiler.

Use the following chart as a guide for cookware material characteristics.

| COOKWARE | CHARACTERISTICS |
|---|--|
| Aluminum | <ul style="list-style-type: none"> ■ Heats quickly and evenly. ■ Suitable for all types of cooking. ■ Medium or heavy thickness is best for most cooking tasks. |
| Cast iron | <ul style="list-style-type: none"> ■ Heats slowly and evenly. ■ Good for browning and frying. ■ Maintains heat for slow cooking. |
| Ceramic or Ceramic glass | <ul style="list-style-type: none"> ■ Follow manufacturer's instructions. ■ Heats slowly, but unevenly. ■ Ideal results on low to medium heat settings. |
| Copper | <ul style="list-style-type: none"> ■ Heats very quickly and evenly. |
| Earthenware | <ul style="list-style-type: none"> ■ Follow manufacturer's instructions. ■ Use on low heat settings. |
| Porcelain enamel-on-steel or cast iron | <ul style="list-style-type: none"> ■ See stainless steel or cast iron. |
| Stainless steel | <ul style="list-style-type: none"> ■ Heats quickly, but unevenly. ■ A core or base of aluminum or copper on stainless steel provides even heating. |

ELECTRONIC OVEN CONTROLS

This manual covers different models. The range you have purchased may have some or all of the items listed. The locations and appearances of the items shown here may not match those of your model.

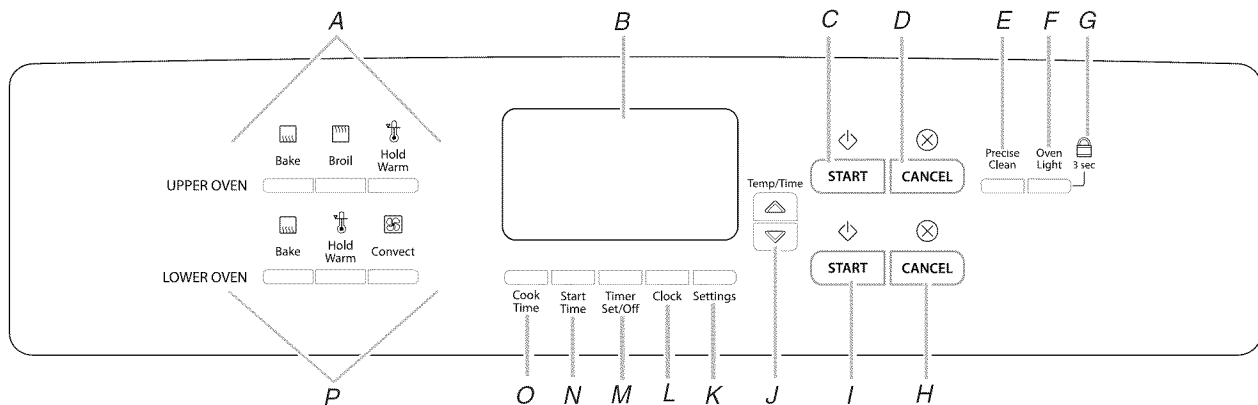

- A. Upper oven settings
- B. Oven display
- C. Upper oven start
- D. Upper oven cancel
- E. Precise Clean™ Feature

- F. Oven light
- G. Control lock
- H. Lower oven cancel
- I. Lower oven start
- J. Temperature/Time adjust

- K. Settings
- L. Clock
- M. Timer set/off
- N. Start time
- O. Cook time
- P. Lower oven settings

Display

When power is first supplied to the range, or if a power failure has occurred, 12:00 will appear on the display. See "Clock" in the "Settings" section to set time of day.

When the oven is not in use, the display shows the time of day.

Cancel

The Cancel pad stops any function except the Clock, Timer and Control Lock.

Oven Light

While the oven doors are closed, press OVEN LIGHT to turn the lights on and off. The oven light will come on when the oven door is opened. The oven light will not come on during the Self-Clean cycle.

Kitchen Timer

The Kitchen Timer can be set in hours or minutes up to 9 hours and 59 minutes, and counts down the set time. The Kitchen Timer does not start or stop the oven.

To Set:

1. Press TIMER SET/OFF pad.
"Set TIMER" will scroll down the upper text display area, and the clock will display "--:--" with the colon flashing.
2. Press the Temp/Time "up" or "down" arrow pads until the desired time is reached.
"Press TIMER" will scroll down the upper text display area.
3. Press TIMER SET/OFF. The colon stops flashing, and the time begins counting down. "TIMER STARTED" will scroll down the upper text display area.
The last minute of the timer countdown will be displayed in seconds.
At the end of the set time, one long beep will sound, and "TIMER End" will be displayed.
4. Press TIMER SET/OFF to clear the display.
NOTE: A reminder beep will sound until the Kitchen Timer is canceled.

To Cancel:

Press the TIMER SET/OFF pad.

Settings

Energy Saver

The Energy Saver mode deactivates the display to reduce energy consumption.

To Activate the Energy Saver Mode:

1. Press and hold SETTINGS for 3 seconds. "Energy saver on." will appear in the upper text area.
2. The setting will be activated after 5 minutes.
Any mode may be used with the range in Energy Saver by simply selecting the desired mode.

To Deactivate the Energy Saver Mode:

1. Press and hold SETTINGS for 3 seconds. "Energy saver off." will appear in the upper text area.
 2. The clock will reappear in the display, and the range can be operated as usual.
-

Fahrenheit and Celsius

The temperature is factory preset to Fahrenheit, but can be changed to Celsius.

1. Press SETTINGS once.
"TEMP UNIT" appears in the upper text area while "Fahrenheit press (^) for Celsius" will scroll twice from right to left in the lower text area.
 2. Press the Temp/Time "up" arrow pad to change the temperature unit setting.
"CELSIUS. Press (^) for Fahrenheit" will scroll twice from right to left in the lower text area.
 3. "CELSIUS Selected" will scroll right to left in the lower text area. The temperature units have been changed.
-

Tones

Tones are audible signals, indicating the following:

Basic Functions

One tone

- Valid pad press
- End of Kitchen Timer (long tone)
- Function has been entered

Two tones

- Oven is preheated

Three tones

- Invalid pad press

Four tones

- End of cycle

Adjusting Sound On or Off

The oven sound is factory set for On but can be changed to Off.

1. Press SETTINGS twice until "SOUND" appears in the upper text area and "ON. Press (^) for OFF" scrolls twice from right to left in the lower text area.
2. Press the Temp/Time "up" arrow pad to turn the sound Off.
"OFF. Press (^) for ON" will scroll twice from right to left in the lower text area. The sound has now been turned off.
3. "OFF Selected" scrolls from right to left in the lower text area. The sound has now been turned off.

Adjusting Sound Volume

The oven sound is factory set for Low but can be changed to High.

1. Press SETTINGS three times until "SOUND VOLUME" scrolls from top to bottom in the upper text area and "LOW Press (^) for HIGH" scrolls twice in the lower text area.
2. Press the Temp/Time "up" arrow pad to turn the sound High.
"HIGH. Press (^) for Low" will scroll twice in the lower text area.
3. "HIGH Selected" scrolls twice in the lower text area. The sound volume has now been changed.

Adjusting End Tone On or Off

The end tone is factory set for On but can be changed to Off.

1. Press SETTINGS four times until "END TONE" scrolls from top to bottom in the upper text area and "ON. Press (^) for OFF" scrolls twice from right to left in the lower text area.
2. Press the Temp/Time "up" arrow pad to turn the end tone off. "OFF. Press (^) for ON" will scroll twice from right to left in the lower text area. The end tone has now been turned off.

Adjusting Keypress Tone On or Off

The keypress tone is factory set for On but can be changed to Off.

1. Press SETTINGS five times until "KEYPRESS TONE" scrolls from top to bottom in the upper text area and "ON. Press (^) for OFF" scrolls twice from right to left in the lower text area.
2. Press the Temp/Time "up" arrow pad to turn the keypress tone Off. "OFF Selected" will scroll twice from right to left in the lower text area. The keypress tone has now been turned off.

Adjusting Reminder Tone On or Off

The reminder tone is factory set for On but can be changed to Off.

1. Press SETTINGS six times until "REMINDER TONE" scrolls from top to bottom in the upper text area and "ON. Press (^) to OFF" scrolls twice from right to left in the lower text area.
2. Press the Temp/Time "up" arrow pad to turn the reminder tone Off. "OFF Selected" will scroll twice from right to left in the lower text area. The reminder tone has now been turned off.

Clock

The clock can be set to display time in a 12-hour or 24-hour format. The clock is set at the factory for the 12-hour format.

To Change the Clock to 24-Hour Format:

1. Press SETTINGS seven times until "12/24 HOUR" appears in the upper text area and "12HR Press (^) for 24Hr" scrolls twice from right to left in the lower text area.
2. Press the Temp/Time "up" arrow pad once to select 24 hour and again to select 12 hour.
3. Wait 30 seconds or press CANCEL to accept the setting.

To Set the Clock:

Before setting, make sure the oven and Kitchen Timer are off.

1. Press CLOCK. "Set Time" appears in the upper text area.
2. Press the Temp/Time "up" or "down" arrow pads until the desired time is displayed.
3. "Press CLOCK" appears in the upper text area and "PUSH START" scrolls from bottom to top in the lower text area.
4. Press CLOCK or START. "Time Set" will scroll from top to bottom in the upper text area for 5 seconds. Once it disappears, the time is set.

Sabbath Mode

Sabbath Mode is used to configure the oven system so that certain features and modes are disabled or defeatured. By enabling Sabbath Mode, the oven will conform to Star-K Jewish Sabbath requirements.

The oven is factory set with Sabbath Mode Off.

To Enable Sabbath mode (one time only):

1. Press SETTINGS eight times until "SABBATH" appears in the upper text area.
2. Press the Temp/Time "up" arrow pad to enable Sabbath Mode. "ON Selected" scrolls twice in the upper text area. The oven is now in Sabbath Mode.

12-Hour Auto Off

The oven control is set to automatically shut off the oven 12 hours after the oven turns on. This will not interfere with any timed or delayed cook function.

To Cancel 12-Hour Auto Off:

1. Press SETTINGS nine times until "12 Hr AUTO_OFF" appears in the upper text area and "ON. Press (^) to OFF" scrolls twice from right to left in the lower text area.
2. Press the Temp/Time "up" arrow pad to turn off the 12-hour Auto Off feature. "OFF. Press (^) to ON" scrolls twice from right to left in the lower text area.
3. "OFF selected" scrolls twice from right to left in the lower text area. The feature has been turned off.

Language

The Language is factory preset to English but can be changed to French or Spanish.

To Change the Language to French:

1. Press SETTINGS 10 times until "LANGUAGE" appears in the upper text area, and "ENGLISH. Press (^) for French Press (v) for Spanish" scrolls twice from right to left in the lower text area.
2. Press the Temp/Time "up" arrow pad to select French. If French is selected, "FRENCH. Press (^) for English Press (v) for Spanish" scrolls twice from right to left in the lower text area.
3. "FRENCH Selected" will scroll twice from right to left in the lower text area. The language displayed will now be French.

To Change the Language to Spanish:

1. Press SETTINGS 10 times until "LANGUAGE" appears in the upper text area, and "ENGLISH. Press (^) for French Press (v) for Spanish" scrolls twice from right to left in the lower text area.
2. Press the Temp/Time "down" arrow pad to select Spanish. If Spanish is selected, "SPANISH. Press (^) for French Press (v) for English" scrolls twice from right to left in the lower text area.
3. "SPANISH Selected" will scroll twice from right to left in the lower text area. The language displayed will now be Spanish.

Oven Temperature Control

The oven provides accurate temperatures; however, it may cook faster or slower than your previous oven, so the temperature calibration can be adjusted. It can be changed in Fahrenheit or Celsius.

Temperature adjustment applies to upper or lower ovens.

A minus sign means the oven will be cooler by the displayed amount. The absence of a minus sign means the oven will be warmer by the displayed amount. Use the following chart as a guide.

| ADJUSTMENT °F (ADJUSTMENT °C) | COOKS FOOD |
|----------------------------------|--------------------|
| 10°F (6°C) | ...a little more |
| 20°F (12°C) | ...moderately more |
| 30°F (17°C) | ...much more |
| -10°F (-6°C) | ...a little less |
| -20°F (-12°C) | ...moderately less |
| -30°F (-17°C) | ...much less |

To Adjust Oven Temperature Calibration:

1. Press SETTINGS 11 times until "TEMP CALIB" appears in the upper text area and "UPPER CALIBRATE. Press (^) for Lower calibrate or push START" scrolls twice from right to left in the lower text area.
2. Press START to calibrate the upper oven. "UPPER calibrate selected" scrolls twice from right to left in the lower text area. "UPPER calibrate" appears in the upper text area, and "Press (^) or (v) for offset" scrolls twice from right to left in the lower text area.

OR

Press the Temp/Time "up" arrow pad to calibrate the lower oven. "LOWER calibrate selected" scrolls twice from right to left in the lower text area. "Lower calibrate" is shown in the upper text area, and "Press (^) or (v) for offset" scrolls twice from right to left in the lower text area.

3. Press the Temp/Time "up" or "down" arrow pad to increase or decrease the temperature in 5°F (3°C) increments. The adjustment can be set between 30°F (17°C) and -30°F (-17°C).
4. Press START to set the adjustment and exit the Temperature Calibration menu.

Control Lockout

The oven controls can be locked out to avoid unintended use of the oven.

The oven controls cannot be locked if the oven is in use, or the oven temperature is 400°F (205°C) or above.

The current time of day will remain in the display when the controls are locked.

To Lock Controls:

1. Press and hold the Oven Light pad for 3 seconds or until "CONTROL LOCKED" scrolls in the upper text area. "CONTROL LOCKED" scrolls while the control is locking, then "LOCKED" is displayed. "LOCKED" remains lit in the display.

To Unlock Controls:

1. Press and hold OVEN LIGHT for 3 seconds. "UNLOCKING" will scroll in the display for 3 seconds while the controls are unlocking, then the time of day is displayed.

OVEN USE

Odors and smoke are normal when the oven is used the first few times, or when it is heavily soiled.

IMPORTANT: The health of some birds is extremely sensitive to the fumes given off. Exposure to the fumes may result in death to certain birds. Always move birds to another closed and well-ventilated room.

Aluminum Foil

IMPORTANT: To avoid permanent damage to the oven bottom finish, do not line the oven bottom with any type of foil, liner or cookware.

- For best cooking results, do not cover entire rack with foil because air must be able to move freely.
- To catch spills, place foil on rack below dish. Make sure foil is at least ½" (1.3 cm) larger than the dish and that it is turned up at the edges.

Positioning Racks and Bakeware

IMPORTANT: To avoid permanent damage to the porcelain finish, do not place food or bakeware directly on the oven door or bottom.

Racks

- Position racks before turning on the oven.
- Do not position racks with bakeware on them.
- Make sure racks are level.
- The upper oven is equipped with 1 flat rack.
- The lower oven is equipped with 2 flat racks.

To Remove Oven Racks:

Flat Racks: Pull rack out to the stop position, raise the front edge, and then lift out.

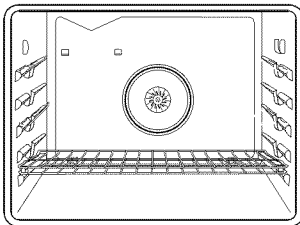

To Replace Oven Racks:

Flat Racks: Place rack on the rack support in the oven. Tilt the front edge up slightly, and slide rack back until it clears the stop position. Lower front and slide back into the oven.

Rack Positions - Upper Oven

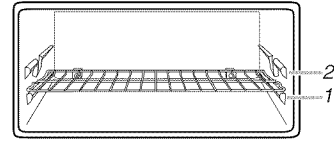

Baking

| FOOD | RACK POSITION |
|--------------|---------------|
| Large dishes | 1 |
| Most foods | 2 |

Broiling

| FOOD | RACK POSITION |
|----------|---------------|
| Broiling | 1 |

Rack Positions - Lower Oven

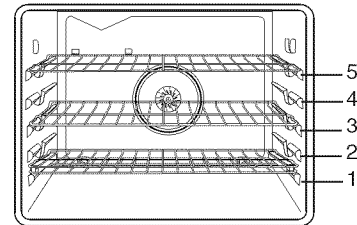

Traditional Cooking

| FOOD | RACK POSITION |
|---|-------------------------------|
| Large roasts, turkeys, angel food, bundt and tube cakes, quick breads, pies | 1 or 2 |
| Yeast breads, casseroles, meat and poultry and 2-rack baking | 2 |
| Cookies, biscuits, muffins, cakes, 1-rack baking | 2 or 3 |
| 2-rack baking | 4 and 5 or 2 and 4 or 2 and 5 |

Convection Cooking (on some models)

| FUNCTION | NUMBER OF RACKS USED | RACK POSITION(S) |
|-------------------------------|----------------------|------------------|
| Convection baking or roasting | 1 | 1, 2 or 3 |
| Convection baking | 2 | 2 and 4 |

BAKEWARE

To cook food evenly, hot air must be able to circulate. Allow 2" (5.0 cm) of space around bakeware and oven walls. Use the following chart as a guide.

| NUMBER OF PAN(S) | POSITION ON RACK |
|------------------|---|
| 1 | Center of rack. |
| 2 | Side by side or slightly staggered. |
| 3 or 4 | Opposite corners on each rack. Make sure that no bakeware piece is directly over another. |

Bakeware

The bakeware material affects cooking results. Follow manufacturer's recommendations and use the bakeware size recommended in the recipe. Use the following chart as a guide.

| BAKEWARE/ RESULTS | RECOMMENDATIONS |
|--|---|
| Light colored aluminum <ul style="list-style-type: none">■ Light golden crusts■ Even browning | <ul style="list-style-type: none">■ Use temperature and time recommended in recipe. |
| Dark aluminum and other bakeware with dark, dull and/or nonstick finish <ul style="list-style-type: none">■ Brown, crisp crusts | <ul style="list-style-type: none">■ May need to reduce baking temperatures slightly.■ Use suggested baking time.■ For pies, breads and casseroles, use temperature recommended in recipe.■ Place rack in center of oven. |
| Insulated cookie sheets or baking pans <ul style="list-style-type: none">■ Little or no bottom browning | <ul style="list-style-type: none">■ Place in the bottom third of oven.■ May need to increase baking time. |
| Stainless steel <ul style="list-style-type: none">■ Light, golden crusts■ Uneven browning | <ul style="list-style-type: none">■ May need to increase baking time. |
| Stoneware/Baking stone <ul style="list-style-type: none">■ Crisp crusts | <ul style="list-style-type: none">■ Follow manufacturer's instructions. |
| Ovenproof glassware, ceramic glass or ceramic <ul style="list-style-type: none">■ Brown, crisp crusts | <ul style="list-style-type: none">■ May need to reduce baking temperatures slightly. |

Meat Thermometer

On models without a temperature probe, use a meat thermometer to determine whether meat, poultry and fish, are cooked to the desired degree of doneness. The internal temperature, not appearance, should be used to determine doneness. A meat thermometer is not supplied with this appliance. Follow manufacturer's directions for using a meat thermometer.

Oven Vents

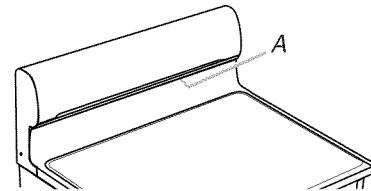

A. Oven vents

The oven vents release hot air and moisture from the ovens, and should not be blocked or covered. Blocking or covering the vents will cause poor air circulation, affecting cooking and cleaning results. Do not set plastics, paper or other items that could melt or burn near the oven vents.

Baking

Before baking, position racks according to the "Positioning Racks and Bakeware" section.

- If only one oven is to be used, that oven will preheat more quickly.
- Allow at least ½" (1.3 cm) between the baking pan or casserole and the top element in the upper oven. Loaf, angel food or bundt pans are not recommended in the upper oven.
- When preheating with a baking/pizza stone inside the upper oven, do not set oven above 400°F (205°C). To use baking/pizza stones at temperatures above 400°F (205°C) in the upper oven, put stone in after the preheat beep.

To Bake or Roast:

1. Press the BAKE keypad for desired oven.
"BAKE" will scroll in the upper or lower text area (depending on oven selection), and 350°F (175°C) will be displayed.
After 3 seconds, "Set temp or" will scroll in the selected oven text area, followed by "Push START."
2. Press the Temp/Time "up" or "down" arrow pads until the desired temperature is displayed.
NOTE: The temperature may be changed at any time by pressing the Temp/Time "up" or "down" arrow pads until the desired temperature is displayed and then START. Changing the temperature once food is placed in the oven could affect the preheat cycle.
3. (Optional) If a Set Cooking Time is desired, press COOK TIME. Press the Temp/Time "up" or "down" arrow pads to adjust the cook time by 5-minute increments until the desired time is displayed.
"Push START" will scroll in the selected oven text area.

4. Press START to begin preheating oven.
“Baking” will appear in the selected oven text area.
After 3 seconds, “Rapid Preheating for single rack baking” will scroll in the selected oven text area until the set temperature is reached.
5. When the preheat cycle is complete, “Preheat done insert food for one rack baking only” will scroll twice in the selected oven text area.
“Bake” will scroll in the selected oven text area until CANCEL for the selected oven is pressed.
6. Place food in the oven.
7. Press UPPER or LOWER CANCEL when finished.
8. Remove food from the oven.

Broiling

Broiling uses direct radiant heat to cook food. The lower the temperature, the slower the cooking. Thicker cuts and unevenly shaped pieces of meat, fish and poultry may cook better at lower broiling temperatures.

- For best results, use a broiler pan and grid. They are designed to drain juices and help avoid spatter and smoke.
If you would like to purchase a broiler pan, one may be ordered. See “Assistance or Service” section to order. Ask for Part Number 4396923.
- For proper draining, do not cover the grid with foil. The bottom of the pan may be lined with aluminum foil for easier cleaning.
- Trim excess fat to reduce spattering. Slit the remaining fat on the edges to avoid curling.
- Select 550°F (288°C) broil for most broiling. Select 450°F (232°C) broil for low-temperature broiling of longer cooking foods such as poultry to avoid overbrowning.

- Pull out oven rack to stop position before turning or removing food. Use tongs to turn food to avoid the loss of juices. Very thin cuts of fish, poultry or meat may not need to be turned.
- After broiling, remove the pan from the oven when removing the food. Drippings will bake on the pan if left in the heated oven, making cleaning more difficult.

Before broiling, position rack according to the Broiling Chart. Position food on grid in the broiler pan, then place it in the center of the oven rack. Close the door.

To Broil Using Hi/Low Temperature Settings:

1. Press BROIL.
“BROIL” appears in the upper text area, and HI will be displayed.
After 3 seconds, “Set temp or” will scroll in the upper text area, followed by “Push START.”
2. Press the Temp/Time “up” or “down” arrow pads to adjust the broil temperature setting to HI or LO.
3. Press START.
“Broiling” will scroll in the upper text area and remains there until the set temperature is reached.
Then “BROIL” will scroll in the upper text area until UPPER CANCEL is pressed.
4. Place food in the oven.
5. Press UPPER CANCEL when finished.
6. Remove food from the oven.

BROILING CHART

Broil times are based on a 5-minute preheat. Times are guidelines only and may need to be adjusted for individual tastes. Turn meat halfway through cooking time. Recommended rack positions are numbered from the bottom (1) to the top (5). For diagram, see the "Positioning Racks and Bakeware" section.

| FOOD | UPPER OVEN RACK POSITION | SETTING | UPPER OVEN COOK TIME (minutes) |
|--|--------------------------|----------|--------------------------------|
| Steak 1" (2.5 cm) thick medium | 1 | HI | 12-16 |
| Ground meat patties 4 oz (113 g), ¾" (2.0 cm) thick up to 12, well-done up to 6, well done | 1 1 | HI HI | 15-20 12-16 |
| Pork chops 1" (2.5 cm) thick, well-done | 1 | HI | 20-25 |
| Chicken bone-in, skin-on breast pieces well-done | 1 | LO | 30-40 |
| Fish* Filets, flaky Steaks, 1" (2.5 cm) thick, flaky | 1 1 | LO LO | 6-7 10-14 |

*When broiling fish, spray broil pan with cooking oil. Do not turn fish filets.

Convection Cooking - Lower Oven Only

(on some models)

During convection cooking, the fan provides increased hot air circulation continuously and more consistently throughout the oven. The movement of heated air around the food helps to speed up cooking by penetrating the cooler outer surfaces. Food cooks more evenly, browning and crisping outer surfaces while sealing moisture inside.

During the Convection function, the ring element operates, along with the fan, to provide an indirect source of heat in the oven cavity. If the oven door is opened during convection cooking or preheating, the element(s) and fan will turn off immediately. Once the door is closed, they will come back on.

- It is important not to cover foods so that surface areas remain exposed to the circulating air, allowing browning and crisping.
- Keep heat loss to a minimum by only opening the oven door only when necessary.
- Choose cookie sheets without sides and roasting pans with lower sides to allow air to move freely around the food.
- Test baked goods for doneness a few minutes before the minimum cooking time with a method such as a toothpick.
- Use a meat thermometer to determine the doneness of meats and poultry. Check the temperature of pork and poultry in 2 or 3 different places, including the thickest part.
- Before convection cooking, position the rack(s) according to the "Positioning Racks and Bakeware" section.

- When using more than one rack, position bakeware/ cookware on the racks to allow movement of the fan circulated air around the food. See the "Positioning Racks and Bakeware" section.
- If the oven is full, extra cooking time may be needed.
- For optimal cooking results, do not cover food.
- When roasting poultry and meat, use a broiler pan and grid. It is not necessary to wait for the oven to preheat, unless recommended in the recipe. To order a broiling pan, see "Assistance or Service" section.

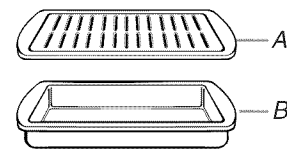

A. Broiler grid
B. Broiler pan

Preheating

During the CONVECT preheating cycle, the fan, ring element (on some models) and bake burner heat the oven cavity. When preheating is finished, the ring element (on some models) cycles to maintain the oven temperature while the fan continues to constantly circulate the heated air.

Convection Baking (on some models)

Use Convection for single or multiple rack baking. When convection baking, reduce the recipe baking temperature by 25°F (15°C).

To Set Convection Bake:

1. Press CONVECT BAKE.
“CONVECT BAKE” will scroll in the lower text area, and 325°F (163°C) will be displayed.
“Set temp or” will scroll in the lower oven text area, followed by “Push START.”
2. Press the Temp/Time “up” or “down” arrow pads until the desired temperature is displayed.
3. Press START.
“CONVECT BAKE” will scroll in the lower oven text area, and “Rapid preheating for single rack Press Start to preheat for multi-rack” will scroll in the lower oven text area until the set temperature is reached. “Preheating” remains in the text area of the display until the set temperature is reached.
4. “Insert food for one rack baking only” will scroll twice in the lower text area once the one rack preheat temperature is reached.
5. “Insert food for multi rack baking only” will scroll twice in the lower text area once the multi rack preheat temperature is reached.
6. When the preheat cycle is complete, “CONVECT BAKE” will scroll in the lower oven text area until LOWER CANCEL is pressed.
7. Place food in the oven.
To change the oven temperature during cooking, press the Temp/Time “up” or “down” arrow pads until the desired temperature is displayed and then START.
8. Press LOWER CANCEL when finished.
9. Remove food from the oven.

Convection Roasting (on some models)

When convection roasting, enter your normal roasting temperature. The roasting time should be set 15 - 30% less than conventional cooking.

It is not necessary to preheat the oven for convection roast.

1. Place food in oven.
2. Press CONVECT ROAST.
“CONVECT ROAST” will scroll in the lower text area, and 325°F (163°C) will be displayed.
“Set temp or” will scroll in the lower oven text area, followed by “Push START.”
3. Press the Temp/Time “up” or “down” arrow pads until the desired temperature is displayed.
4. Press START.
“CONVECT ROAST” will scroll in the lower oven text area.
“Preheating” will scroll in the lower oven text area until the set temperature is reached.
5. When the preheat cycle is complete, “CONVECT ROAST” will scroll in the lower text area. The set temperature will also be displayed.

6. To change the oven temperature during cooking, press the Temp/Time “up” or “down” arrow pads until the desired temperature is displayed and then START.
“CONVECT ROAST” will scroll in the selected oven text area until LOWER CANCEL is pressed.
7. Press LOWER CANCEL when finished.
8. Remove food from the oven.

Hold Warm Feature

WARNING

Food Poisoning Hazard

Do not let food sit in oven more than one hour before or after cooking.

Doing so can result in food poisoning or sickness.

IMPORTANT: Food must be at serving temperature before placing it in the warmed oven. Food may be held up to 1 hour; however, breads and casseroles may become too dry if left in the oven during the Hold Warm feature.

The Hold Warm feature allows hot cooked foods to stay at serving temperature. It can also be used at the end of a timed cook.

Follow manufacturer’s recommendations when warming empty serving bowls and plates.

To Use:

1. Press the HOLD WARM keypad for desired oven.
“HOLD WARM” will scroll in the upper or lower text area (depending on oven selection), and 170°F (77°C) will be displayed.
“Set temp or” will scroll in the selected oven text area, followed by “Push START.”
2. Press the Temp/Time “up” or “down” arrow pads to adjust the temperature by 5°F (3°C) increments until the desired temperature is displayed.
The temperature can be set from 145°F (63°C) to 190°F (85°C).
NOTE: The temperature may be changed at any time by pressing the Temp/Time “up” or “down” arrow pads until the desired temperature is displayed and then START. Changing the temperature once food is placed in the oven could affect the preheat cycle.
3. Press START.
“Hold Warm” will appear in the text area, and the set temperature will be displayed.
4. “HOLDING WARM” and the temperature will be displayed while the Hold Warm setting is active or until UPPER or LOWER CANCEL is pressed.
5. Place food in the oven.
To change the oven temperature during cooking, press the Temp/Time “up” or “down” arrow pads until the desired temperature is displayed and then START.
6. Press UPPER or LOWER CANCEL when finished.
7. Remove food from the oven.

To Cancel Hold Warm Feature:

Press UPPER or LOWER CANCEL. Remove food from oven.

Automatic Shutoff/Sabbath Mode

The oven control is set to automatically shut off the oven 12 hours after the oven is turned on. This feature can be turned off to enable Sabbath Mode.

- 12 Hour Shutoff Mode is disabled during an active Sabbath mode.
- All tones and chimes are disabled during an active Sabbath mode.
- All cooking and cleaning modes, except for Bake, are disabled.
- All keys are disabled during an active Sabbath mode except for Cancel, Start, Kitchen Timer, and the Temp/Time “up” and “down” arrow pads.
- Oven lights status will remain in the state they were in before entering into the Active Sabbath mode.
- Once in the Active Sabbath mode, the oven light will not respond to the Oven Light key or the door being opened.
- Timers are disabled during Active Sabbath mode.
- Cooktop burners can be enabled for use during Sabbath mode.
- Cooktop lockout (if applicable) is disabled during the Sabbath mode.
- Energy saver is disabled during Sabbath mode.

To Enable Sabbath Mode (one time only):

1. Open the lower oven door.
2. Press LOWER CANCEL.
3. Press and hold the Temp/Time “up” arrow pad for 5 seconds. Sabbath on” appears in the upper text display area, and “Press START to enter” scrolls in the lower text display area.
4. Press START to confirm your selection.

“Sabbath Mode - on Holidays press (^) to change temp by +25F and (v) to change temp by -25F and press Start” scrolls in upper text display area. Sabbath mode is now enabled but is not yet active.

5. Close oven door.

A bake function for either, or both, ovens must be started before Sabbath Mode can be activated. The bake function may be set with Cook Time or Delay Start, if desired. See the “Baking” or “Delay Start” sections for more information.

To Disable Sabbath Mode:

1. Open the lower oven door.
2. Press LOWER CANCEL.
3. Press and hold the Temp/Time “up” arrow pad for 5 seconds. Sabbath off” appears in the upper text display area.
4. Close the oven door.

To Activate or Deactivate an Enabled Sabbath Mode:

Sabbath Mode can be activated or deactivated at any time during an enabled Sabbath Mode.

1. With a timed or untimed Bake function started (see the “Baking” section for help starting Bake), press and hold TIMER SET/OFF for 5 seconds. “Sabbath Bake” appears in the upper text area for 3 seconds.

For a Timed Bake function, the time will also be displayed.

After 3 seconds, the display will continuously scroll “Sabbath Mode- on Holidays press (^) to change temp by +25F and (v) to change temp by -25F and press Start.”

To Adjust Temperature (when Sabbath Mode is running in only one oven):

1. Press the Temp/Time “up” or “down” arrow pads. Each press of the pads will increase or decrease temperature by 25°F (14°C). No temperature will appear in the display.
2. Press and hold START longer than 1 second to set the temperature change.

To Adjust Temperature (when Sabbath Mode is running in both ovens):

1. Press BAKE for the desired oven.
2. Press the Temp/Time “up” or “down” arrow pads. Each press of the pads will increase or decrease temperature by 25°F (14°C). No temperature will appear in the display.
3. Press and hold START longer than 1 second to set the temperature change.

To Deactivate an Enabled Sabbath Mode:

1. Press and hold TIMER SET/OFF for 5 seconds to return to regular baking or press CANCEL to turn off the oven(s).

If a Power Failure Occurs During Sabbath Mode

If a power failure occurs during Sabbath Mode, the upper text area will display “Sabbath.” Press UPPER or LOWER CANCEL to exit Sabbath Mode and return to the Automatic Shutoff Mode.

Start Time

⚠ WARNING

Food Poisoning Hazard

Do not let food sit in oven more than one hour before or after cooking.

Doing so can result in food poisoning or sickness.

Start Time allows the oven(s) to cook for a set length of time. It allows the oven(s) to be set to turn on at a certain time of day. Start Time should not be used for food such as breads and cakes because they may not bake properly.

Start Time is available with the Upper or Lower oven or with any cooking or cleaning function. Before setting, a stop time must be entered.

For more information on using Delay Clean, see “To Delay Clean” in the “Range Care” section.

To Set a Delay Start:

1. Press START TIME.
“PRESS (^) FOR UPPER OVEN” will scroll from top to bottom in the upper text area, and “PRESS (v) FOR LOWER OVEN” will scroll from bottom to top in the lower text area.
2. Press the Temp/Time “up” or “down” arrow pads to select the desired oven.
“--:--” will be displayed, and “Set starting time. Push START” will scroll from right to left in the selected oven text area for 2 minutes or until the Temp/Time “up” or “down” arrow pads are pressed again.
3. Press the Temp/Time “up” or “down” arrow pads until the desired time is reached.

“Select cooking/cleaning mode” will scroll in the selected oven text area for 2 minutes or until a cooking cycle is selected.

4. Press the desired cooking cycle key for upper or lower oven. The name of the cooking function will scroll in the selected oven text area, and a temperature value will be displayed. After 3 seconds, "Set temp or" will scroll in the selected oven text area.
5. Press the Temp/Time "up" or "down" pads until the desired temperature is displayed. "Push START" will scroll in the selected oven text area.
6. The cook time can be changed if desired by pressing the Temp/Time "up" or "down" arrow pads until the desired time is reached.
7. Press START.

The selected cooking cycle will begin, and the name will scroll in the upper text area.

8. Place food in the oven.

To change the oven temperature during cooking, press the Temp/Time "up" or "down" arrow pads until the desired temperature is displayed and then START.

The cooking function name will remain in the selected oven text area until the cook time countdown is complete. Then "Cooking Complete" will scroll in the selected oven text area until UPPER or LOWER CANCEL is pressed or the oven door is opened.

9. Press UPPER or LOWER CANCEL when finished.
10. Remove food from the oven.

RANGE CARE

Self-Cleaning Cycle (on some models)

⚠ WARNING



Burn Hazard

Do not touch the oven during the Self-Cleaning cycle.

Keep children away from oven during Self-Cleaning cycle.

Failure to follow these instructions can result in burns.

IMPORTANT: The health of some birds is extremely sensitive to the fumes given off during the Self-Cleaning cycle. Exposure to the fumes may result in death to certain birds. Always move birds to another closed and well-ventilated room.

Self-clean the oven before it becomes heavily soiled. Heavy soil results in longer cleaning and more smoke.

Keep the kitchen well-ventilated during the Self-Cleaning cycle to help get rid of heat, odors, and smoke.

Do not block the oven vent(s) during the Self-Cleaning cycle. Air must be able to move freely. Depending on your model, see "Oven Vent" or "Oven Vents" section.

Do not clean, rub, damage or move the oven door gasket. The door gasket is essential for a good seal.

Prepare Oven:

- Remove the broiler pan, grid, cookware and bakeware and, on some models, the temperature probe from the oven.
- Remove oven racks to keep them shiny and easy to slide. See "General Cleaning" section for more information.
- Remove any foil from the oven because it may burn or melt, damaging the oven.
- Hand clean inside door edge and the 1½" (3.8 cm) area around the inside oven cavity frame, being certain not to move or bend the gasket. This area does not get hot enough during self-cleaning to remove soil. Do not let water, cleaner, etc., enter slots on door frame. Use a damp cloth to clean this area.

- Wipe out any loose soil to reduce smoke and avoid damage. At high temperatures, foods react with porcelain. Staining, etching, pitting or faint white spots can result. This will not affect cooking performance.

Prepare Cooktop:

- Remove plastic items from the cooktop because they may melt.

IMPORTANT:

Oven temperature must be below 400°F (205°C) to program a clean cycle.

Only 1 oven can be cleaned at a time.

The cooktop burners will not function during self clean.

Both oven doors lock when either oven is being cleaned.

How the Cycle Works

IMPORTANT: The heating and cooling of porcelain on steel in the oven may result in discoloring, loss of gloss, hairline cracks and popping sounds.

The Self-Cleaning cycle uses very high temperatures, burning soil to a powdery ash.

The oven is preset for a 3 hour clean cycle; however the time can be changed. Suggested clean times are 2 hours for light soil and between 3 hours and 4 hours for average to heavy soil.

Once the oven has completely cooled, remove ash with a damp cloth. To avoid breaking the glass, do not apply a cool damp cloth to the inner door glass before it has completely cooled.

The oven light will not work during the Self-Cleaning cycle.

When "LOCK" shows in the display, the door cannot be opened. To avoid damage to the door, do not force the door open when "LOCK" is displayed.

If an oven door is left open, "Door open clean cancelled" will appear in the display and a signal will beep. Close the door and press CLEAN.

To Self-Clean:

1. Close the oven door.
2. Press PRECISE CLEAN.

"PRESS (^) FOR UPPER OVEN" will scroll in the upper oven text area and "PRESS (v) FOR LOWER OVEN" will scroll in the lower oven text area,

3. Press the Temp/Time “up” or “down” arrow pads to select the desired oven.
“REMOVE RACKS” will scroll in the selected oven text area.
4. Press the Temp/Time “up” or “down” arrow pad. “Precise Clean” scrolls in the upper text display area, and “PUSH START” scrolls in the lower text display area.
5. Press START.
“Set Clean Time” scrolls in the lower text display area. Press the Temp/Time “up” or “down” arrow pads to adjust the clean time.
6. Press START.
7. “UNLOCK IN XXX” will scroll in the upper or lower text area (depending on oven selection). “LOCKING” will scroll until the door is locked.
After the door is locked, “CLEAN UPPER” or “CLEAN LOWER” will scroll in the selected oven text area until the clean cycle is finished.

When the self-clean cycle ends:

“CLN COMPLETE will scroll in the selected oven text area. After 5 seconds, “OVEN COOLING” will scroll in the display until the oven temperature falls below 500°F (260°C).
“UNLOCKING” will be displayed until the oven door unlocks and the lock icon turns off.

To Delay Start Self-Clean:

Before delay starting Self-Clean, make sure the oven door is completely closed or it will not lock and the cycle will not begin.

1. Press START TIME.
“PRESS (^) FOR UPPER OVEN” will scroll in the upper text area, and “PRESS (v) FOR LOWER OVEN” will scroll in the lower text area.
2. Press the Temp/Time “up” or “down” arrow pads to select the desired oven.
“--:--” will be displayed, and “Set starting time. Push START” will scroll from right to left in the selected oven text area for 2 minutes or until the Temp/Time “up” or “down” arrow pads are pressed again.
3. Press the Temp/Time “up” or “down” arrow pads until the desired time is reached.
“Select cooking/cleaning mode” will scroll in the selected oven text area for 2 minutes or until a cooking cycle is selected.
4. Press PRECISE CLEAN.
“REMOVE RACKS” will scroll in the selected oven text area for 5 seconds, followed by “SELECT OPTION.” In the other text area, “PRESS up or down KEY” will scroll from left to right.
5. Press the Temp/Time “up” or “down” arrow pads until the desired temperature is displayed.
“Push START” will scroll in the selected oven text area.
6. Press the Temp/Time “up” or “down” arrow pads to select the desired cleaning level. The desired clean level and “PUSH START” will scroll in the displays.
7. Press START.
The cleaning cycle will begin, and the name will scroll in the upper text area.
8. “UNLOCK IN XXX” will scroll in the upper or lower text area (depending on oven selection). After 5 seconds, “LOCKING” will scroll until the door is locked.
After the door is lock, “CLEAN UPPER” or “CLEAN LOWER” will scroll in the selected oven text area until the clean cycle is finished.

When the self-clean cycle ends:

“CLN COMPLETE will scroll in the selected oven text area. After 5 seconds, “OVEN COOLING” will scroll in the display until the oven temperature falls below 500°F (260°C).
“UNLOCKING” will be displayed until the oven door unlocks and the lock icon turns off.

General Cleaning

IMPORTANT: Before cleaning, make sure all controls are off and the oven and cooktop are cool. Always follow label instructions on cleaning products.

Soap, water and a soft cloth or sponge are suggested first unless otherwise noted.

EXTERIOR PORCELAIN ENAMEL SURFACES

Food spills containing acids, such as vinegar and tomato, should be cleaned as soon as the entire range is cool. These spills may affect the finish.

Cleaning Method:

- Glass cleaner, mild liquid cleaner or nonabrasive scrubbing pad: Gently clean around the model and serial number plate because scrubbing may remove numbers.
- All-Purpose Appliance Cleaner Part Number 31682 (not included):
See “Assistance or Service” section to order.

STAINLESS STEEL (on some models)

To avoid damage to stainless steel surfaces, do not use soap-filled scouring pads, abrasive cleaners, Cooktop Cleaner, steel-wool pads, gritty washcloths or abrasive paper towels.

Cleaning Method:

Rub in direction of grain to avoid damaging.

- Stainless Steel Cleaner and Polish Part Number 31462 (not included): See “Assistance or Service” section to order.
- Liquid detergent or all-purpose cleaner: Rinse with clean water and dry with soft, lint-free cloth.

PORCELAIN-COATED GRATES AND CAPS

Food spills containing acids, such as vinegar and tomato, should be cleaned as soon as the cooktop, grates and caps are cool. These spills may affect the finish.

To avoid chipping, do not bang grates and caps against each other or hard surfaces such as cast iron cookware.

Do not reassemble caps on burners while they are wet.

Cleaning Method:

- Nonabrasive plastic scrubbing pad and mildly abrasive cleanser:
Clean as soon as cooktop, grates and caps are cool.
- Dishwasher (grates only, not caps):
Use the most aggressive cycle. Cooked-on soils should be soaked or scrubbed before going into a dishwasher.
- Gas Grate and Drip Pan Cleaner Part Number 31617:
See “Assistance or Service” section to order.

COOKTOP CONTROLS

To avoid damage to the cooktop controls, do not use steel wool, abrasive cleansers or oven cleaner.

To avoid damage, do not soak knobs.

When removing or replacing knobs, make sure knobs are in the Off position.

Do not remove seals under knobs, if present.

Cleaning Method:

- Warm, soapy water:
Pull knobs straight away from control panel to remove.

CONTROL PANEL

To avoid damage to the control panel, do not use abrasive cleaners, steel-wool pads, gritty washcloths or abrasive paper towels.

To avoid turning the controls on while cleaning, you may activate the Control Lock feature (on some models). See "Oven Door and Control Lockout" section.

Cleaning Method:

- Glass cleaner and soft cloth or sponge: Apply glass cleaner to soft cloth or sponge, not directly on panel.
- All-Purpose Appliance Cleaner Part Number 31682 (not included):
See "Assistance or Service" section to order.

OVEN DOOR EXTERIOR

Cleaning Method:

- Glass cleaner and paper towels or nonabrasive plastic scrubbing pad: Apply glass cleaner to soft cloth or sponge, not directly on panel.
- All-Purpose Appliance Cleaner Part Number 31682 (not included):
See "Assistance or Service" section to order.

OVEN CAVITY

Do not use oven cleaners.

Food spills should be cleaned when oven cools. At high temperatures, foods react with porcelain and staining, etching, pitting or faint white spots can result.

Cleaning Method:

- Self-Cleaning cycle: See "Self-Cleaning Cycle" first.

OVEN RACKS

Cleaning Method:

- Self-Cleaning cycle: See "Self-Cleaning Cycle" first. Remove racks, or they will discolor and become harder to slide. If this happens, a light coating of vegetable oil applied to the rack guides will help them slide.
- Steel-wool pad

Oven Light

The ovens light is a standard 40-watt appliance bulb.

Before replacing, make sure the oven and cooktop are cool and the control knobs are off.

To Replace:

1. Unplug range or disconnect power.
2. Turn the glass bulb cover in the back of the oven counterclockwise to remove.

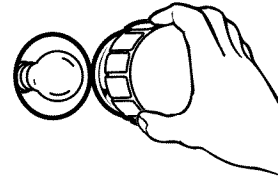

3. Turn bulb counterclockwise to remove from socket.
4. Replace bulb, then bulb cover by turning clockwise.
5. Plug in range or reconnect power.

Oven Door

IMPORTANT:

To avoid oven door glass breakage:

- Do not close the oven door if the racks are not fully inserted into the oven cavity or when bakeware extends past the front edge of an oven rack.
- Do not set objects on the glass surface of the oven door.
- Do not hit glass surfaces with bakeware or other objects.
- Do not wipe down glass surfaces until the oven has completely cooled.

For normal range use, it is not suggested to remove the oven door. However, if removal is necessary, make sure the oven is off and cool. Then, follow these instructions. The oven door is heavy.

To Remove:

1. Open oven door all the way.
2. Pull forward and down on the hinge latch on each side.

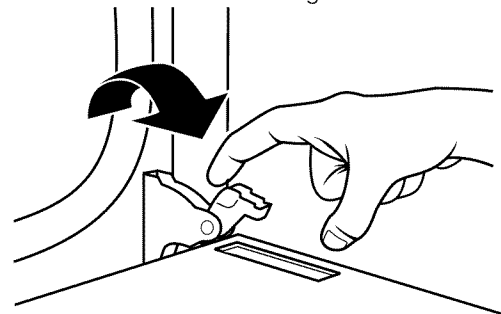

3. Close the oven door as far as it will shut.
4. Lift the oven door while holding both sides.

Continue to push the oven door closed and pull it away from the oven door frame.



To Replace:

1. Insert both hanger arms into the door.



2. Open the oven door.
You should hear a “click” as the door is set into place.
3. Move the hinge levers back to the locked position. Check that the door is free to open and close. If it is not, repeat the removal and installation procedures.

TROUBLESHOOTING

Try the solutions suggested here first in order to avoid the cost of an unnecessary service call.

Nothing will operate

⚠ WARNING



Electrical Shock Hazard

Plug into a grounded 3 prong outlet.

Do not remove ground prong.

Do not use an adapter.

Do not use an extension cord.

Failure to follow these instructions can result in death, fire, or electrical shock.

- **Is the power supply cord unplugged?**
Plug into a grounded 3 prong outlet.
- **Household fuse blown or circuit breaker tripped?**
Replace the fuse or reset the circuit breaker. If the problem continues, call an electrician.
- **Is the main or regulator gas shutoff valve in the off position?**
See Installation Instructions.
- **Is the range properly connected to the gas supply?**
Contact a trained repair specialist or see Installation Instructions.

Surface burners will not operate

- **Is this the first time the surface burners have been used?**
Turn on any one of the surface burner knobs to release air from the gas lines.
- **Is the control knob set correctly?**
Push in knob before turning to a setting.
- **Are the burner ports clogged?**
See “Sealed Surface Burners” section.

Surface burner flames are uneven, yellow and/or noisy

- **Are the burner ports clogged?**
See “Sealed Surface Burners” section.
- **Are the burner caps positioned properly?**
See “Sealed Surface Burners” section.
- **Is propane gas being used?**
The range may have been converted improperly. Contact a service technician or see “Assistance or Service” section.

Surface burner makes popping noises

- **Is the burner wet?**
Let it dry.

Excessive heat around cookware on cooktop

- **Is the cookware the proper size?**
Use cookware about the same size as the surface cooking area, element or surface burner. Cookware should not extend more than ½” (1.3 cm) outside the cooking area.

Cooktop cooking results not what expected

- **Is the proper cookware being used?**
See “Cookware” section.
- **Is the control knob set to the proper heat level?**
See “Cooktop Controls” section.
- **Is the range level?**
Level the range. See the Installation Instructions.

Oven will not operate

- **Is this the first time the oven has been used?**
Turn on any one of the surface burner knobs to release air from the gas lines.
- **Is the electronic oven control set correctly?**
See “Electronic Oven Control(s)” section.
- **On some models, is the Control Lock set?**
See “Control Lockout” section.

Oven burner flames are yellow or noisy

- **Is propane gas being used?**
The range may have been converted improperly. Contact a service technician or see “Assistance or Service” section.

Oven temperature too high or too low

- **Does the oven temperature calibration need adjustment?**
See “Oven Temperature Control” section.

Display shows messages

- **Is the display showing a flashing time?**
There has been a power failure. Clear the display. On some models, reset the clock, if needed. See “Clock” in the “Settings” section.
- **Is the display showing a letter followed by a number?**
Depending on your model, press CANCEL to clear the display. If it reappears, call for service. See “Assistance or Service” section.

Self-Cleaning cycle will not operate

- **Is the oven door open?**
The display will show “door.” Close the oven door all the way.
- **Has the function been entered?**
See “Self-Cleaning Cycle” section.
- **On some models, has a delay start Self-Clean cycle been set?**
See “Self-Cleaning Cycle” section.
- **Has a delay start been set?**
See “Start Time” section.
- **Is the oven temperature above 400°F (205°C)?**
Let the oven cool before using the self-clean cycle.

Oven cooking results not what expected

- **Is the range level?**
Level the range. See the Installation Instructions.
- **Is the proper temperature set?**
Double-check the recipe in a reliable cookbook.
- **Is the proper oven temperature calibration set?**
See “Oven Temperature Control” section.
- **Was the oven preheated?**
See “Baking” section.
- **Is the proper bakeware being used?**
See “Bakeware” section.
- **Are the racks positioned properly?**
See “Positioning Racks and Bakeware” section.
- **Is there proper air circulation around bakeware?**
See “Positioning Racks and Bakeware” section.
- **Is the batter evenly distributed in the pan?**
Check that batter is level in the pan.
- **Is the proper length of time being used?**
Adjust cooking time.
- **Has the oven door been opened while cooking?**
Oven peeking releases oven heat and can result in longer cooking times.
- **Are baked items too brown on the bottom?**
Move rack to higher position in the oven.
- **Are pie crust edges browning early?**
Use aluminum foil to cover the edge of the crust and/or reduce baking temperature.

ASSISTANCE OR SERVICE

Before calling for assistance or service, please check "Troubleshooting." It may save you the cost of a service call. If you still need help, follow the instructions below.

When calling, please know the purchase date and the complete model and serial number of your appliance. This information will help us to better respond to your request.

If you need replacement parts

If you need to order replacement parts, we recommend that you use only FSP® replacement parts. FSP® replacement parts will fit right and work right because they are made with the same precision used to build every new WHIRLPOOL® appliance.

To locate FSP® replacement parts in your area, call us or your nearest Whirlpool designated service center.

In the U.S.A.

Call the Whirlpool Customer eXperience Center toll free: **1-800-253-1301**.

Our consultants provide assistance with:

- Features and specifications on our full line of appliances.
- Installation information.
- Use and maintenance procedures.
- Accessory and repair parts sales.
- Specialized customer assistance (Spanish speaking, hearing impaired, limited vision, etc.).
- Referrals to local dealers, repair parts distributors and service companies. Whirlpool designated service technicians are trained to fulfill the product warranty and provide after-warranty service, anywhere in the United States.

To locate the Whirlpool designated service company in your area, you can also look in your telephone directory Yellow Pages.

For further assistance

If you need further assistance, you can write to Whirlpool Corporation with any questions or concerns at:

Whirlpool Brand Home Appliances
Customer eXperience Center
553 Benson Road
Benton Harbor, MI 49022-2692

Please include a daytime phone number in your correspondence.

Accessories

Accessories U.S.A.

To order accessories, call the Whirlpool Customer eXperience Center toll free at **1-866-664-2449** and follow the menu prompts. Or visit our website at **www.whirlpool.com** and click on "Parts & Accessories."

Accessories

Broiler Pan and Grid

Order Part Number 4396923

Stainless Steel Cleaner and Polish

(stainless steel models)

Order Part Number 31462

All-Purpose Appliance Cleaner

Order Part Number 31682

WHIRLPOOL CORPORATION MAJOR APPLIANCE WARRANTY

LIMITED WARRANTY

For one year from the date of purchase, when this major appliance is operated and maintained according to instructions attached to or furnished with the product, Whirlpool Corporation or Whirlpool Canada LP (hereafter "Whirlpool") will pay for Factory Specified Parts and repair labor to correct defects in materials or workmanship. Service must be provided by a Whirlpool designated service company. This limited warranty is valid only in the United States or Canada and applies only when the major appliance is used in the country in which it was purchased. Outside the 50 United States and Canada, this limited warranty does not apply. Proof of original purchase date is required to obtain service under this limited warranty.

ITEMS EXCLUDED FROM WARRANTY

This limited warranty does not cover:

1. Service calls to correct the installation of your major appliance, to instruct you on how to use your major appliance, to replace or repair house fuses, or to correct house wiring or plumbing.
2. Service calls to repair or replace appliance light bulbs, air filters or water filters. Consumable parts are excluded from warranty coverage.
3. Repairs when your major appliance is used for other than normal, single-family household use or when it is used in a manner that is contrary to published user or operator instructions and/or installation instructions.
4. Damage resulting from accident, alteration, misuse, abuse, fire, flood, acts of God, improper installation, installation not in accordance with electrical or plumbing codes, or use of consumables or cleaning products not approved by Whirlpool.
5. Cosmetic damage, including scratches, dents, chips or other damage to the finish of your major appliance, unless such damage results from defects in materials or workmanship and is reported to Whirlpool within 30 days from the date of purchase.
6. Any food loss due to refrigerator or freezer product failures.
7. Costs associated with the removal from your home of your major appliance for repairs. This major appliance is designed to be repaired in the home and only in-home service is covered by this warranty.
8. Repairs to parts or systems resulting from unauthorized modifications made to the appliance.
9. Expenses for travel and transportation for product service if your major appliance is located in a remote area where service by an authorized Whirlpool servicer is not available.
10. The removal and reinstallation of your major appliance if it is installed in an inaccessible location or is not installed in accordance with published installation instructions.
11. Major appliances with original model/serial numbers that have been removed, altered or cannot be easily determined. This warranty is void if the factory applied serial number has been altered or removed from your major appliance.

The cost of repair or replacement under these excluded circumstances shall be borne by the customer.

DISCLAIMER OF IMPLIED WARRANTIES; LIMITATION OF REMEDIES

CUSTOMER'S SOLE AND EXCLUSIVE REMEDY UNDER THIS LIMITED WARRANTY SHALL BE PRODUCT REPAIR AS PROVIDED HEREIN. IMPLIED WARRANTIES, INCLUDING WARRANTIES OF MERCHANTABILITY OR FITNESS FOR A PARTICULAR PURPOSE, ARE LIMITED TO ONE YEAR OR THE SHORTEST PERIOD ALLOWED BY LAW. WHIRLPOOL SHALL NOT BE LIABLE FOR INCIDENTAL OR CONSEQUENTIAL DAMAGES. SOME STATES AND PROVINCES DO NOT ALLOW THE EXCLUSION OR LIMITATION OF INCIDENTAL OR CONSEQUENTIAL DAMAGES, OR LIMITATIONS ON THE DURATION OF IMPLIED WARRANTIES OF MERCHANTABILITY OR FITNESS, SO THESE EXCLUSIONS OR LIMITATIONS MAY NOT APPLY TO YOU. THIS WARRANTY GIVES YOU SPECIFIC LEGAL RIGHTS, AND YOU MAY ALSO HAVE OTHER RIGHTS WHICH VARY FROM STATE TO STATE OR PROVINCE TO PROVINCE.

If outside the 50 United States and Canada, contact your authorized Whirlpool dealer to determine if another warranty applies.

If you need service, first see the "Troubleshooting" section of the Use & Care Guide. After checking "Troubleshooting," you may find additional help by checking the "Assistance or Service" section or by calling Whirlpool. In the U.S.A., call **1-800-253-1301**. In Canada, call **1-800-807-6777**.

9/07

Keep this book and your sales slip together for future reference. You must provide proof of purchase or installation date for in-warranty service.

Write down the following information about your major appliance to better help you obtain assistance or service if you ever need it. You will need to know your complete model number and serial number. You can find this information on the model and serial number label located on the product.

Dealer name _____
Address _____
Phone number _____
Model number _____
Serial number _____
Purchase date _____

