

FRIGIDAIRE

All about the

Use & Care

of your Gas Range

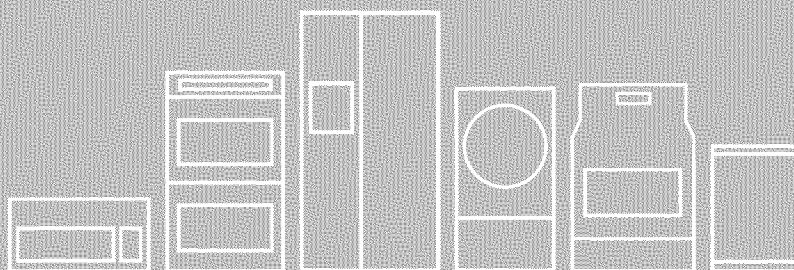

TABLE OF CONTENTS

Important Safety Instructions	3-6	Setting Oven Controls	11-16
Features at a Glance	7	Self-Cleaning	17-18
Before Setting Oven Controls	8	Care & Cleaning	19-21
Before Setting Surface Controls	9	Before You Call	22-23
Setting Surface Controls	10	Major Appliance Warranty	24
Oven Control Functions (300)	11		

PRODUCT RECORD AND REGISTRATION

Contents

Product Registration	2
Important Safety Instructions	3-6
Features at a Glance	7
Before Setting Oven Controls	8
Removing, replacing & arranging the oven racks	8
Before Setting Surface Controls	9
Cookware material types	9
Setting Surface Controls	10
Setting surface burners	10
Home canning	10
Oven Controls Functions	11
Setting Oven Controls	11-16
Setting the clock	11
Changing temperature display (F° or C°)	11
Setting silent control feature	12
Setting minute timer	12
Changing between continuous bake or 12-Hour Energy Saving features	12
Setting bake	13
Setting bake time	13
Setting bake time and start time	14
Setting broil	15
Adjusting oven temperature	16
Setting oven lockout feature	16
Operating oven light	16
Self-Cleaning	17-18
Care & Cleaning	19-21
Cleaning recommendations table	19
Cleaning the cooktop and surface burners	20
Replacing oven light	21
Removing & replacing oven door	21
Before You Call - Solutions to common problems...	22-23
Appliance Warranty	24

Thank you for choosing **Frigidaire**.

This Use & Care Guide is part of our commitment to customer satisfaction and product quality throughout the service life of your new appliance. We view your purchase as the beginning of a relationship. To ensure our ability to continue serving you, please use this page to record important product information.

Need help??

Visit the **Frigidaire web site at www.frigidaire.com**

Before you call for service, there are a few things you can do to help us serve you better.

Read this Use & Care manual.

It contains instructions to help you use and maintain your range properly.

If you received a damaged range ...

immediately contact the dealer (or builder) that sold you the range.

Save time and money.

Check the section titled "Before you call". This section helps step you through some common problems that might occur. If you do need service, help is only a phone call away. Call Frigidaire Customer Services at **1-800-944-9044**.

Product Registration

Registering your product with Frigidaire enhances our ability to serve you. You can register online at **www.frigidaire.com** or by dropping your Product Registration Card in the mail.

Serial plate location

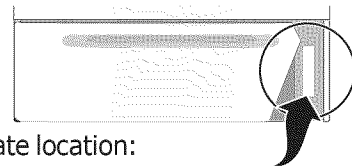

Serial plate location:
open storage drawer (some models) or
remove lower front panel (some models).

Record model & serial numbers here

Purchase date

Model number

Serial number

IMPORTANT SAFETY INSTRUCTIONS

Read all instructions before using this appliance.

Do not attempt to install or operate your appliance until you have read the safety precautions in this manual. Safety items throughout this manual are labeled with a WARNING or CAUTION statement based on the risk type.

Definitions

! This is the safety alert symbol. It is used to alert you to potential personal injury hazards. Obey all safety messages that follow this symbol to avoid possible injury or death.

! WARNING

WARNING indicates a potentially hazardous situation which, if not avoided, may result in death or serious injury.

! CAUTION

CAUTION indicates a potentially hazardous situation which, if not avoided, may result in minor or moderate injury.

➔ IMPORTANT

IMPORTANT indicates installation, operation, maintenance or valuable information that is not hazard related.

Important Safety Instructions

- **Remove all tape and packaging before using the range.** Destroy the carton and plastic bags after unpacking the range. Never allow children to play with packaging material.
- **Proper Installation—Be sure your appliance is properly installed and grounded by a qualified technician in accordance with the National Fuel Gas Code ANSI Z223.- latest edition, or in Canada CAN/CGA B149.1, and CAN/CGA B149.2, and the National Electrical Code ANSI/NFPA No.70-latest edition, or in Canada CSA Standard C22.1, Canadian Electrical Code, Part 1, and local code requirements.** Install only per installation instructions provided in the literature package for this range. Ask your dealer to recommend a qualified technician and an authorized repair service. Know how to disconnect the power to the range at the circuit breaker or fuse box in case of an emergency.

! WARNING

If the information in this manual is not followed exactly, a fire or explosion may result causing property damage, personal injury or death.

FOR YOUR SAFETY:

- **Do not store or use gasoline or other flammable vapors and liquids in the vicinity of this or any other appliance.**
- **WHAT TO DO IF YOU SMELL GAS:**
 - **Do not try to light any appliance.**
 - **Do not touch any electrical switch; do not use any phone in your building.**
 - **Immediately call your gas supplier from a neighbor's phone. Follow the gas supplier's instructions.**
 - **If you cannot reach your gas supplier, call the fire department.**
- **Installation and service must be performed by a qualified installer, servicer or the gas supplier.**

! WARNING

- **All ranges can tip.**
- **Injury to persons could result.**
- **Install anti-tip device packed with range.**
- **See Installation Instructions.**



To reduce the risk of tipping, the range must be secured by properly installed anti-tip bracket provided with the range. To check if the bracket is installed properly, visually check that rear leveling leg is inserted into and fully secured by the anti-tip bracket by removing lower front panel or storage drawer from the range.



For models equipped with a warmer drawer or lower oven, grasp the top rear edge of the range and carefully attempt to tilt it forward. Refer to the installation instructions for proper anti-tip bracket installation.

- **Never modify or alter the construction of a range by removing the leveling legs, panels, wire covers, anti-tip brackets/screws, or any other part of the range.**

Save these instructions for future reference.

IMPORTANT SAFETY INSTRUCTIONS

WARNING

NEVER use this appliance as a space heater to heat or warm the room. Doing so may result in carbon monoxide poisoning.

NEVER cover any slots, holes or passages in the oven bottom or cover an entire rack with materials such as aluminum foil. Doing so blocks air flow through the oven and may cause carbon monoxide poisoning. Aluminum foil linings may trap heat, causing a fire hazard.

Stepping, leaning or sitting on the door or drawers of a range can result in serious injuries and also cause damage to the appliance. DO NOT allow children to climb or play around the range. The weight of a child on an open oven door may cause the range to tip, resulting in serious burns or other injury.

Storage in or on appliance—flammable materials should not be stored in an oven, near surface units or in the storage drawer, warmer drawer or lower oven. This includes paper, plastic and cloth items, such as cookbooks, plasticware and towels, as well as flammable liquids. Do not store explosives, such as aerosol cans, on or near the range.

DO NOT LEAVE CHILDREN ALONE—children should not be left alone or unattended in the area where appliance is in use. They should never be allowed to sit or stand on any part of the appliance, including the storage drawer, lower broiler drawer, warmer drawer or lower double oven.

CAUTION

Do not store items of interest to children in the cabinets above a range or on the backguard of the range. Children climbing on the range to reach items could be seriously injured.

- **Remove the oven door from any unused range if it is to be stored or discarded.**
- **User servicing—Do not repair or replace any part of the appliance unless specifically recommended in the manuals.** All other servicing should be done only by a qualified technician. This may reduce the risk of personal injury and damage to the range.

IMPORTANT

For electric ignition models only: Do not attempt to operate the range during a power failure. If the power fails, always turn off the range. If the range is not turned off and the power resumes, the range will begin to operate again. Once the power resumes, reset the clock and oven function.

CAUTION

- **DO NOT TOUCH SURFACE BURNERS, AREAS NEAR THESE BURNERS, OVEN BURNERS OR INTERIOR SURFACES OF THE OVEN.** Both surface and oven burners may be hot even though flames are not visible. Areas near surface burners may become hot enough to cause burns. During and after use, do not touch, or let clothing or other flammable materials touch these areas until they have had sufficient time to cool. Among these areas are the cook top, surfaces facing the cook top, the oven vent openings and surfaces near these openings, oven door and window.
- **Wear proper apparel—loose-fitting or hanging garments should never be worn while using the appliance.** Do not let clothing or other flammable materials contact hot surfaces.
- **Do not use water or flour on grease fires—smother the fire with a pan lid, or use baking soda, a dry chemical or foam-type extinguisher.**
- **When heating fat or grease, watch it closely.** Fat or grease may catch fire if allowed to become too hot.
- **Use dry potholders - moist or damp potholders on hot surfaces may result in burns from steam.** Do not let potholders touch hot heating elements. Do not use a towel or other bulky cloth instead of a potholder.
- **Do not heat unopened food containers - buildup of pressure may cause container to burst and result in injury.**

IMPORTANT SAFETY INSTRUCTIONS

IMPORTANT INSTRUCTIONS FOR USING YOUR COOKTOP

WARNING

Use Proper Flame Size—Adjust flame size so it does not extend beyond the edge of the utensil. The use of undersized utensils will expose a portion of the burner flame to direct contact and may result in ignition of clothing. Proper relationship of utensil to flame will also improve efficiency.

- **Know which knob controls each surface burner.** Place a pan of food on the burner before turning it on, and turn the burner off before removing the pan.
- **Always turn knob to the full LITE position when igniting top burners.** Visually check that burner has lit. Then adjust the flame so it does not extend beyond the edge of the utensil.
- **Utensil handles should be turned inward and not extend over adjacent surface burners**—To reduce the risk of burns, ignition of flammable materials, and spillage due to unintentional contact with the utensil, the handle of the utensil should be positioned so that it is turned inward, and does not extend over adjacent surface burners.
- **Never leave surface burners unattended at high heat settings**—Boilovers cause smoking and greasy spillovers that may ignite, or a pan that has boiled dry may melt.
- **Glazed cooking utensils**—Only certain types of glass, glass/ceramic, ceramic, earthenware, or other glazed utensils are suitable for cook top service without breaking due to the sudden change in temperature. Check the manufacturer's recommendations for cook top use.
- **When flaming foods under a ventilating hood, turn the fan on.**
- **Air curtain or other overhead range hoods**, which operate by blowing a downward air flow on to a range, shall not be used in conjunction with gas ranges other than when the hood and range have been designed, tested and listed by an independent test laboratory for use in combination with each other.

IMPORTANT INSTRUCTIONS FOR USING YOUR OVEN

- **Use care when opening oven door , warmer drawer or lower oven door**—Stand to the side of the range when opening the door of a hot oven. Let hot air or steam escape before you remove or replace food in the oven.
- **Keep Oven Vent Ducts Unobstructed.** The oven vent is located below the backguard. Touching the surfaces in this area when the oven is operating may cause severe burns. Also, do not place plastic or heat-sensitive items on or near the oven vent. These items could melt or ignite.
- **Placement of Oven Racks.** Always place oven racks in desired location while oven is cool. If rack must be moved while oven is hot use extreme caution. Use potholders and grasp the rack with both hands to reposition. Do not let potholders contact the hot heating elements in the oven. Remove all utensils from the rack before moving.
- **Do not use the broiler pan without its insert.** The broiler pan and its insert allow dripping fat to drain and be kept away from the high heat of the broiler.
- **Do not cover the broiler insert with aluminum foil.** Exposed fat and grease could ignite.
- **Protective liners**—Do not use aluminum foil to line the oven bottom. Only use aluminum foil as recommended in this manual. Improper installation of these liners may result in risk of electric shock, or fire.

SELF-CLEANING OVENS

- **Clean in the self-cleaning cycle only the parts listed in this Use & Care Manual.** Before self-cleaning the oven, remove the broiler pan and any utensils or foods from the oven.
- **Do Not Use Oven Cleaners**—No commercial oven cleaner or oven liner protective coating of any kind should be used in or around any part of the oven.
- **Do Not Clean Door Gasket**—The door gasket is essential for a good seal. Care should be taken not to rub, damage or move the gasket.
- The health of some birds is extremely sensitive to the fumes given off during the self-cleaning cycle of any range. Move birds to another well-ventilated room.

IMPORTANT SAFETY INSTRUCTIONS

IMPORTANT INSTRUCTIONS FOR CLEANING YOUR RANGE

- **Clean the range regularly to keep all parts free of grease that could catch fire.** Pay particular attention to the area around each surface burner. Do not allow grease to accumulate.
- **Kitchen cleaners and aerosols—Always follow the manufacturer's recommended directions for use.** Be aware that excess residue from cleaners and aerosols may ignite causing damage and injury.
- **Clean ventilating hoods frequently—Grease should not be allowed to accumulate on the hood or filter.** Follow the manufacturer's instructions for cleaning hoods.

Important Safety Notice

The California Safe Drinking Water and Toxic Enforcement Act requires the Governor of California to publish a list of substances known to the state to cause cancer, birth defects or other reproductive harm, and requires businesses to warn customers of potential exposure to such substances.

Grounding Instructions

See the **INSTALLATION INSTRUCTIONS** packaged with this range for complete installation and grounding instructions.

WARNING

Avoid fire hazard or electrical shock. Do not use an adapter plug, an extension cord, or remove grounding prong from electrical power cord. Failure to follow this warning can cause serious injury, fire or death.

This appliance is equipped with a 3-prong grounding plug for your protection against shock hazard and should be plugged directly into a properly grounded receptacle. **DO NOT** cut or remove the grounding prong from this plug.

For personal safety, the range must be properly grounded. For maximum safety, the power cord must be plugged into an electrical outlet that is correctly polarized and properly grounded.

If a 2-prong wall receptacle is the only available outlet, it is the personal responsibility of the consumer to have it replaced with a properly grounded 3-prong wall receptacle installed by a qualified electrician.

Grounding type wall receptacle

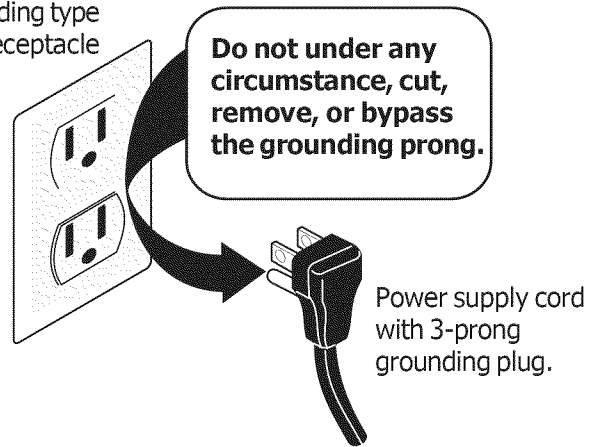

Conversion to Liquefied Petroleum Gas

WARNING

Personal injury or death from electrical shock may occur if the range is not installed by a qualified installer or electrician.

Any additions, changes or conversions required in order for this appliance to satisfactorily meet the application needs must be made by a qualified technician.

If your gas range model is designed to allow for L.P. conversion, the L.P. conversion kit may be obtained from your local appliance dealer and should be installed by a qualified service technician. Before installing the kit be sure to follow the L.P. Installation Instructions carefully.

FEATURES AT A GLANCE

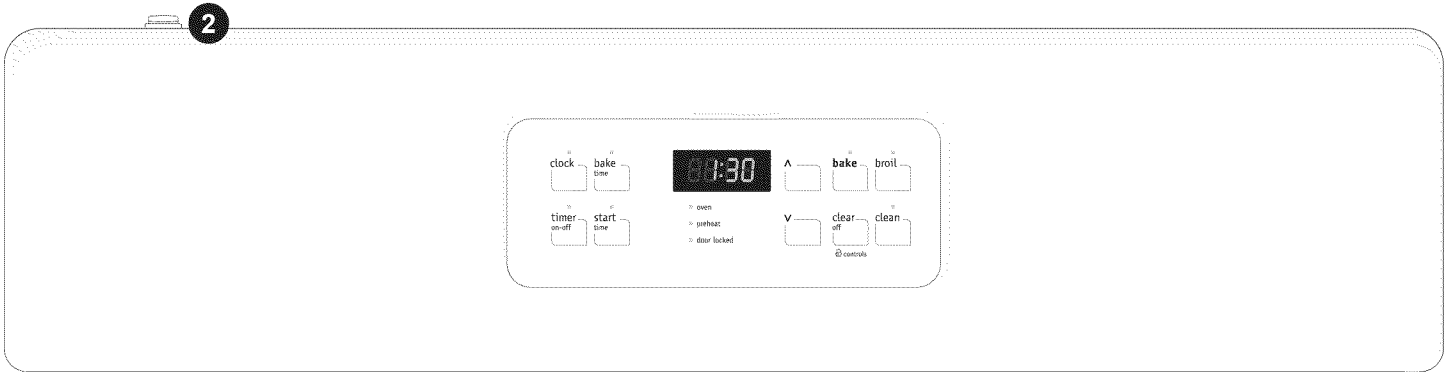

Your gas range features include:

NOTE

The features shown may vary from your appliance according to model type & color.

1. Electronic oven control with kitchen timer.
2. Oven light switch (some models).
3. Left front burner valve and control knob.
4. Left rear burner valve and control knob.
5. Right front burner valve and control knob.
6. Right rear burner valve and control knob.
7. Burner grates (colors and styles vary with model).
8. Interior oven light with removable cover.
9. Automatic oven door light switch (some models).
10. Self-cleaning oven interior.
11. Self-clean door latch.
12. Adjustable interior oven rack(s).
13. Large 1-piece oven door handle.
14. Full width oven door with window.
15. Storage drawer with integrated handle (some models) or lower cover panel (some models).
16. Easy to clean upswept cooktop.
17. 5,000 BTU simmer burner (some models).
18. 9,500 BTU standard burner (some models).
19. 12,000 BTU burner (some models).
20. 14,000 BTU burner (some models).
21. 17,000 BTU burner (some models).
22. Broil pan (some models).
23. Broil pan insert (some models).
24. Leveling legs and **anti-tip** bracket (included).

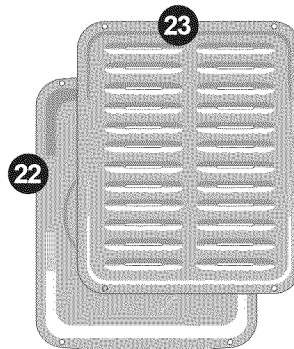
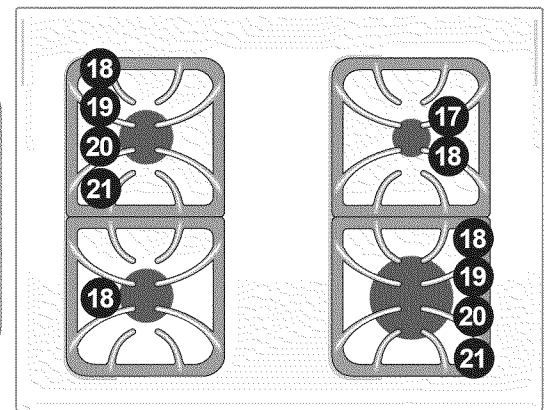
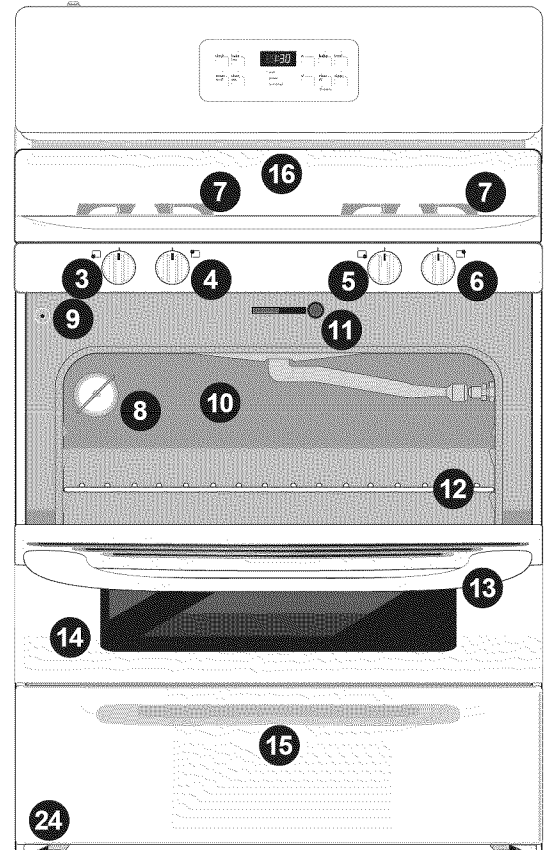

Be sure to visit us online at
www.frigidaire.com
 for a complete line of accessories.

BEFORE SETTING OVEN CONTROLS

Oven vent location

The oven vent is located **below the control panel** (See Fig. 1). When the oven is on, warm air passes through this vent. This venting is necessary for proper air circulation in the oven and good baking results. **Do not block the oven vent.**

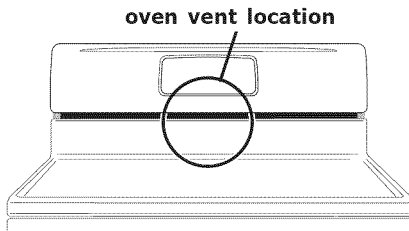

Fig. 1

Removing, replacing & arranging racks

To remove - pull the rack forward until it stops. Lift up front of rack and slide out.

To replace - fit the rack onto the guides on the oven walls. Tilt the front of the rack upward and slide the rack back into place.

Arranging - always arrange the oven racks when the oven is cool (prior to operating the oven).

CAUTION

Always use oven mitts when using the oven. When using the appliance, oven racks and cooktop will become very hot which can cause burns.

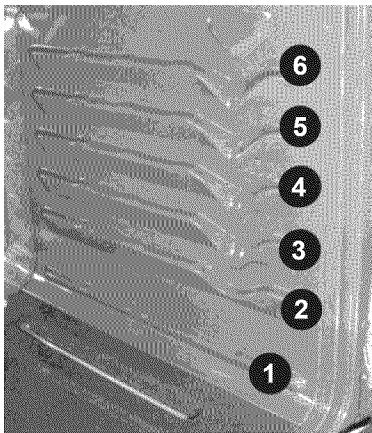
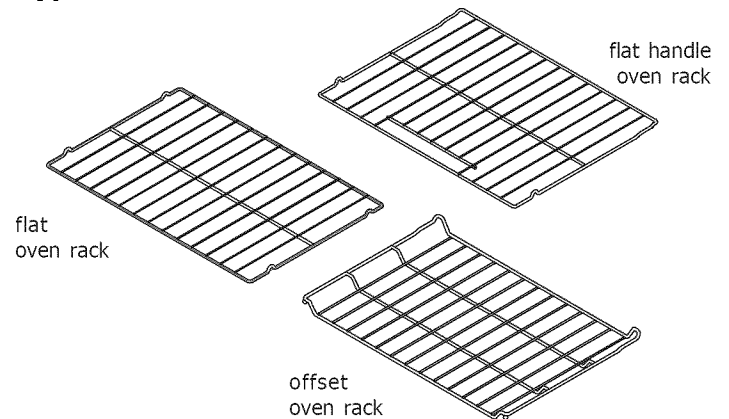

Fig. 2

Recommended rack positions by food type

Food type	Position
Broiling meats	See broil
Cookies, cakes, pies, biscuits & muffins	3 or 4
Frozen pies, angel food cake, yeast, bread and casseroles	1 or 2
Small cuts of meat or poultry	1 or 2
Turkey, roast or ham	1

Types of oven racks



The **flat oven rack** or **flat handle oven rack** (some models) may be used for most cooking needs.

The **offset oven rack** (some models) is designed to place the base of the rack about 1/2 of a rack position lower than normal. This rack design provides several additional possible positions between the standard positions.

Air circulation in the oven

For best baking results allow 2-4" (5-10 cm) around the cookware for proper air circulation and be sure pans and cookware do not touch each other, the oven door, sides or back of the oven cavity. Hot air must be able to circulate around the pans and cookware in the oven for even heat to reach around the food.

Baking layer cakes with 1 or 2 oven racks

For best results when baking cakes using 2 oven racks, place cookware on rack positions 2 & 5 (See Figs. 2 & 3). For best results when using a single oven flat rack, place cookware on rack positions 2, 3 or 4 (See Figs. 2 & 4).

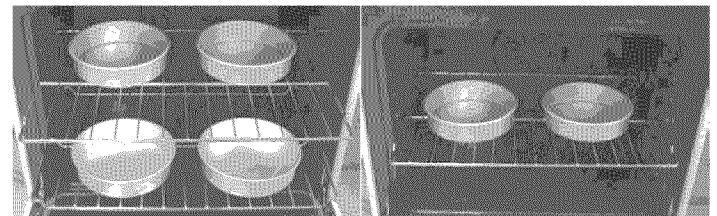

Fig. 3

Fig. 4

BEFORE SETTING SURFACE CONTROLS

Using proper cookware

For best cooking results, cookware should have flat bottoms that rests level on the burner grate. Before using cookware, check for flatness by rotating a ruler across the bottom of the cookware (Fig. 1).

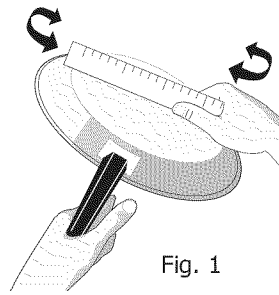

Fig. 1

CAUTION

Do not place flammable items such as plastic salt and pepper shakers, spoon holders or plastic wrappings on the cooktop when it is in use. These items could melt or ignite. Potholders, towels or wooden spoons could catch fire if placed too close to the range cooktop.

IMPORTANT

Do not place aluminum foil, or ANY material that can melt on the range cooktop. If these items melt they may damage the cooktop.

NOTE

The size and type of utensil used, and the amount and type of food being cooked will influence the setting needed for best cooking results.

Cookware material types

The most popular materials available are:

Aluminum - Excellent heat conductor. Some types of food will cause it to darken (Anodized aluminum cookware resists staining & pitting).

Copper - Excellent heat conductor but discolors easily.

Stainless - Slow heat conductor with uneven cooking results. Is durable, easy to clean and resists staining.

Cast Iron - A slow heat conductor however will retain heat very well. Cooks evenly once cooking temperature is reached.

Porcelain-enamel on metal - Heating characteristics will vary depending on base material.

Glass - Slow heat conductor.

Set proper burner flame size

The color of the flame is the key to proper burner adjustment. A good flame is clear, blue and hardly visible in a well-lighted room. Each cone of flame should be steady and sharp. Adjust or clean burner if flame is yellow-orange.

For most cooking; start on the highest setting and then turn to a lower setting to complete the process. Use the recommendations below as a guide for determining proper flame size for various types of cooking (Fig. 2)

For deep fat frying; use a thermometer and adjust the surface knob accordingly. If the fat is too cool, the food will absorb the fat and be greasy. If the fat is too hot, the food will brown so quickly that the center will be under cooked. Do not attempt to deep fat fry too much food at once as the food will neither brown or cook properly.

Flamesize*	Type of cooking
High flame	Start most foods; bring water to a boil; pan broiling.
Medium flame	Maintain a slow boil; thicken sauces, gravies; steaming.
Low flame	Keep foods cooking; poach; stewing.

* These settings are based for medium-weight metal or aluminum pans with lids. Settings may vary when using other types of pans.

Fig. 2

CAUTION

Never extend the flame beyond the outer edge of the cooking utensil. A higher flame wastes energy, and increases your risk of being burned by the flame (Fig. 3).

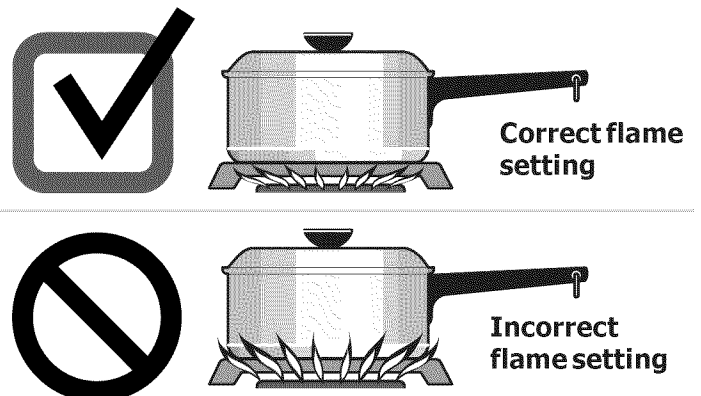

Fig. 3

SETTING SURFACE CONTROLS

Setting surface controls

Your gas appliance may be equipped with different sized surface burners. The ability to heat food quicker and in larger volumes increases as the burner size increases. It is important to select cookware that is suitable for the amount and type of food being prepared.

The smaller **simmer** burner (some models) is best suited for simmering delicate sauces, etc.

The **standard** size (9,500 BTU) burners may be used for most surface cooking needs.

The larger (**Quick Boil** - some models) burner or burners are best used for bringing large quantities of liquid to temperature and when preparing larger quantities of food.

Setting surface burners

1. Place cooking utensil on center of surface burner grate. Make sure the utensil is centered and stable on the grate.
2. Push the desired surface control knob in and turn **counterclockwise** out of the OFF position (Fig. 1).
3. Release the knob and rotate to the **LITE** position. Visually check that the gas burner has lit.
4. Push the control knob in and turn **counterclockwise** to the desired flame size. Use the control knob markings and adjust the flame as needed.

CAUTION

Do not place flammable items such as plastic salt and pepper shakers, spoon holders or plastic wrappings on the cooktop when it is in use. These items could melt or ignite. Potholders, towels or wooden spoons could catch fire if placed too close to the range cooktop.

NOTES

DO NOT cook with the surface control knob left in the LITE position. The electronic ignitor will continue to spark if the control knob is left in the LITE position.

When setting any surface control knob to the LITE position, all electronic surface ignitors will spark at the same time. However, only the surface burner you are setting will ignite.

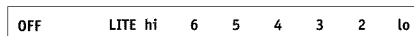
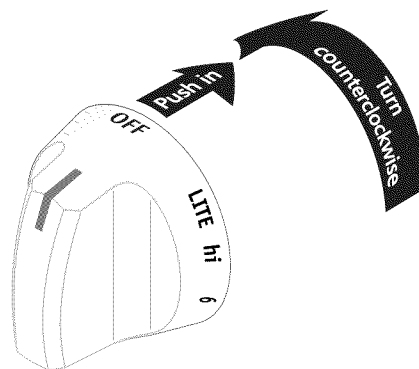

Fig. 1

IMPORTANT

- **NEVER** place or straddle a cooking utensil over 2 different surface cooking areas at the same time.
- **Do not place aluminum foil, or ANY material that can melt on the range cooktop.** If these items melt they may permanently damage the cooktop surface.
- In the event of an electrical power outage, the surface burners can be lit manually. Use caution when lighting surface burners manually. To light a surface burner, hold a lit match to the burner head, then slowly turn the surface control knob to **LITE**. After burner lights push in and turn knob to desired setting.

Home Canning

Be sure to read and observe all the following points when home canning with your appliance. Check with the USDA (United States Department of Agriculture) website and be sure to read all the information they have available as well as follow their recommendations for home canning procedures.

- Use only quality flat bottom canners when home canning. Use a straight-edge to check canner bottom.
- Use only a completely flat bottom canner with no ridges that radiate from the bottom center when home canning using a ceramic cooktop.
- Make sure the diameter of the canner does not exceed 1 inch beyond the surface element markings or burner. It is recommended to use smaller diameter canners on electric coil and ceramic glass cooktops.
- Start with hot tap water to bring water to boil more quickly.
- Use the highest heat setting when first bringing the water to a boil. Once boiling is achieved, reduce heat to lowest possible setting to maintain that boil.

OVEN CONTROL FUNCTIONS

READ THE INSTRUCTIONS CAREFULLY BEFORE USING THE OVEN.

For satisfactory use of your oven, become familiar with the various pad features and functions of the oven as described below.

Feature indicator lights— These indicator lights show which feature is active.

Bake time pad— Use to enter the length of baking time desired.

Up and down arrow pads— Use with the feature or function pads to set oven temperature, bake time, start time, clean time (when programming an automatic start time), setting or adjusting the clock and minute timer.

Bake pad—Use to select the bake feature.

Clock pad— Use to set the time of day.

Timer on-off pad— Use to set or cancel the minute timer. The minute timer does not start or stop cooking. **Timer on-off pad** is used to set the continuous bake function.

Start time pad— Use to set the desired start time for baking & Self-Clean. May be used with **bake time** to program a delayed timed bake.

Oven, preheat & door locked lights* — The "oven" light will glow each time the oven turns on to maintain the set oven temperature. The "preheat" light will glow when the oven is first set to operate, or if the desired temperature is reset higher than the actual oven temperature. The "door locked" light will flash when the oven door locks and unlocks, the oven door lockout is active or when the self-clean cycle feature is active.

Broil pad— Use to select the variable broil feature.

Clean pad— Use to set a Self-Clean cycle.

Clear off pad— Use to clear any feature previously entered except the time of day and minute timer. Press **clear off** to stop cooking. Also use **clear off** to activate oven lockout feature.



SETTING OVEN CONTROLS

Setting the clock

When the appliance is first plugged in or when the power supply to the appliance has been interrupted, the display will flash "12:00". It is recommended to always set the clock for the correct time of day before using the appliance.

To set the clock

1. Press **clock** once (do not hold key pad down).
2. Within 5 seconds, press and hold the **Λ** or **V** until the correct time of day appears in the display.

NOTE

The clock cannot be changed when **the oven is set** or **clean** is active.

Changing the temperature display mode (°F or °C)

The display may be changed to show or Fahrenheit or Celsius oven temperatures. The oven control is set to display °F (Fahrenheit) when shipped from the factory.

NOTE

The temperature display mode cannot be changed when **the oven is set** or **clean** is active.

To change the temperature display mode from °F to °C (Celsius) or from °C to °F (Fahrenheit)

1. Press **broil**. "— —" appears in the display.
2. Press and hold the **Λ** until "HI" appears in the display.
3. Press and hold **broil** until °F or °C appears in the display.
4. Press the **Λ** or **V** to change °F to °C or °C to °F.
5. Press any control pad to return to normal operating mode.

SETTING OVEN CONTROLS

Setting a silent control panel

When choosing a function, a tone will be heard each time a keypad is pressed. If desired, the control can be programmed for silent operation.

To block the controls from sounding when any keypad is pressed in the future, press and hold **start time** keypad for 6 seconds. The control will beep once then release the keypad.

To return the tones, press and hold **start time** again for 6 seconds until the control beeps once.

Setting the minute timer

1. Press **timer on-off**.
2. Press the **▲** to increase the time in one minute increments. Press and hold the **▲** to increase the time in 10 minute increments. The timer can be set for any amount of time from 1 minute to 11 hours and 59 minutes.

Note: If the **▼** pad is pressed first, the timer will advance to 11 hours and 59 minutes.

3. When the set time has run out, the timer will beep 3 times and will continue to beep 3 times every 60 seconds until **timer on-off** is pressed.

To change the timer while it is in use

While the timer is active and shows in the display, press and hold the **▲** or **▼** to increase or decrease the time remaining.

To cancel the minute timer before the set time has run out

Press **timer on-off** once .

NOTES

- The indicator light located above the **timer on-off** pad will glow while the minute timer is active.
- The minute timer will display hours and minutes until 1 hour remains on the timer. Once less than 1 hour remains, the display will count down in minutes and seconds. Once the timer has less than 1 minute remaining only seconds will display.
- The minute timer **will not** start or stop the cooking process. It serves as an extra timer in the kitchen that will beep when the set time has run out. The minute timer can be used alone or while using any of the other oven features. If another feature is active when the minute timer is active, the minute timer will show in the display. To view information about other active features, press the pad for that feature.

Changing between continuous bake setting or 12-Hour Energy Saving feature

The oven control has a built-in 12-Hour Energy Saving feature that will shut off the oven if the oven is left on for more than 12 hours. The oven control can be programmed to override this feature for continuous baking.

Changing to continuous bake setting:

1. Press and hold **timer on-off** down for 6 seconds until a tone sounds. " — — hr" will appear in display for continuous cooking. The current time of day will return to the display.
2. To cancel the continuous bake setting, press **timer on-off** and hold for 6 seconds until a tone sounds. "12hr" will appear in display indicating that the control has returned to the 12-Hour Energy Saving feature.

IMPORTANT

This feature does not change how the cooktop controls operate.

SETTING OVEN CONTROLS

Setting bake

The oven can be programmed to bake at any temperature from 170°F to 550°F (77°C to 287°C). The factory preset automatic bake temperature is 350°F (177°C).

To set bake

1. Press **bake**. "— — —" appears in the display.
2. Within 5 seconds, press the **▲** or **▼**. The display will show "350°F (177°C)." By pressing and holding the **▲** or **▼**, the temperature can then be adjusted in 5°F increments (1°C if the control is set to display Celsius).
3. As soon as the **▲** or **▼** pad is released, the oven will begin heating to the selected temperature. When the displayed temperature reaches the desired baking temperature, the preheat indicator light will turn OFF and the control will beep 3 times.

To change the oven temperature after bake has started

1. Press **bake**. Visually check the bake temperature and that it needs to be changed.
2. Press the **▲** or **▼** pad to increase or decrease the set temperature to the desired new oven temperature.

NOTES

- The **oven** indicator light on the electronic display will turn ON and OFF when using the Bake feature and during preheat. This is normal and indicates that the oven is cycling to maintain the selected baking temperature.
- When the **preheat** indicator light turns OFF, your oven is ready.
- To cancel baking at any time, press **clear off**.

IMPORTANT

Dark or dull pans absorb more heat than shiny bakeware resulting in dark or overbrowning of foods. It may be necessary to reduce the oven temperature or cook time to prevent overbrowning of some foods. Dark pans are recommended for pies. Shiny pans are recommended for cakes, cookies and muffins.

Setting bake time

The **bake time** pad sets the amount of time needed for baking. The oven will turn on immediately and stop automatically after the set bake time ends.

WARNING

FOOD POISONING HAZARD. Do not let food sit for more than one hour before or after cooking. Doing so can result in food poisoning or sickness.

CAUTION

Use caution with the timed bake and delayed timed bake features. Foods that can easily spoil such as milk, eggs, fish, meat or poultry, should be chilled in the refrigerator first. Even when chilled, they should not stand in the oven for more than 1 hour before cooking begins, and should be removed promptly when cooking is finished.

To program the oven to begin baking immediately and to shut off automatically (timed bake)

1. Be sure that the clock displays the correct time of day.
2. Place the food in the oven.
3. Press **bake**. "— — — °" appears in the display.
4. Within 5 seconds, press the **▲** or **▼**. The display will show "350°F (177°C)." By holding the **▲** or **▼**, the temperature can be adjusted in 5°F increments (1°C if the control is set to display Celsius).
5. Press **bake time**. ":00" will appear in the display.
6. Press the **▲** or **▼** until the desired baking time appears in the display.
7. The oven will turn ON and begin heating.

NOTES

- Bake time will not operate when using the broil feature.
- To cancel baking at any time, press **clear off**.

SETTING OVEN CONTROLS

Setting bake time and start time

The **bake time** and **start time** pads may be used to set the length of baking time and to delay the starting time (delayed timed bake). The oven will turn on at a later time and stop automatically after the set bake time ends.

To program oven for a delayed start time and to shut-off automatically

1. Be sure that the clock displays the correct time of day.
2. Place food in the oven.
3. Press **bake**. " — — — ° " appears in the display.
4. Within 5 seconds, press the **▲** or **▼** . The display will show "350°F (177°C)." By holding the **▲** or **▼** , the temperature can then be adjusted in 5°F increments (1°C if the control is set to display Celsius).
5. Press **bake time**. ":00" will appear in the display.
6. Press the **▲** or **▼** until the desired baking time appears.
7. Press **start time**. The time of day will appear in the display.
8. Press the **▲** or **▼** until the desired start time appears in the display.
9. Once the controls are set, the control calculates the time when baking will stop.
10. The oven will turn ON at the delayed start time and begin heating. The oven will turn OFF after the set bake time ends.

When the set bake time runs out

1. "End" will appear in the display window and the oven will shut-off automatically.
2. The control will beep 3 times every 60 seconds as a reminder until **clear off** is pressed.

To change the oven temperature or bake time after baking has started

1. Press the function pad you want to change.
2. Press the **▲** or **▼** to adjust the setting.

WARNING

FOOD POISONING HAZARD. Do not let food sit for more than one hour before or after cooking. Doing so can result in food poisoning or sickness.

CAUTION

Use caution with the timed bake and delayed timed bake features. Foods that can easily spoil such as milk, eggs, fish, meat or poultry, should be chilled in the refrigerator first. Even when chilled, they should not stand in the oven for more than 1 hour before cooking begins, and should be removed promptly when cooking is completed.

IMPORTANT

Dark or dull pans absorb more heat than shiny bakeware resulting in dark or overbrowning of foods. It may be necessary to reduce the oven temperature or cook time to prevent overbrowning of some foods. Dark pans are recommended for pies. Shiny pans are recommended for cakes, cookies and muffins.

NOTE

During a delayed timed bake the preheat indicator light will not function until the set time to start cooking is reached.

SETTING OVEN CONTROLS

Setting broil

Use the broil feature to cook meats that require direct exposure to flame heat for optimum browning results. When broiling always remember to arrange the oven racks while oven is still cool. Position the oven rack as suggested in the **broil settings table** (See Fig. 3).

To set broil

1. Arrange the oven rack while oven is still cool.
2. Press **broil**. " — — "will appear in display.
3. Press and hold the **▲** or **▼** until the desired broil setting level appears in the display. Press the **▲** for **HI** broil or the **▼** for **LO** broil. Most foods may be broiled at the **HI** broil setting. Select the **LO** broil setting to avoid excess browning or drying of foods that should be cooked to the well-done stage.
4. **For optimum browning, preheat the oven for 5 minutes before adding food.**
5. Place the insert on the broil pan (if equipped), then place the food on the broil pan insert (if equipped).
6. Place the broiler pan and insert on the oven rack (if equipped-See Figs. 1 & 2).
7. **Close the oven door.**
8. Broil on one side until food is browned. Turn and broil food on 2nd side. For recommended broil settings and times refer to Fig. 3.
9. When broiling is finished press **clear off**.

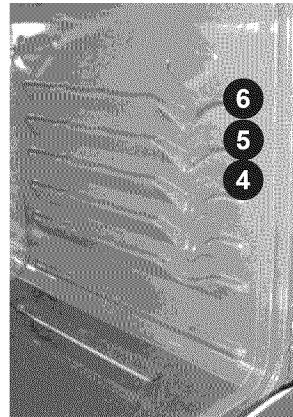

Fig. 1

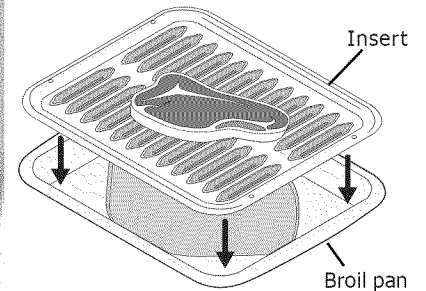

Fig. 2

WARNING

Should an oven fire occur, close the oven door and turn the oven OFF. If the fire continues, use a fire extinguisher. **DO NOT** put water or flour on the fire. Flour may be explosive.

CAUTION

- The broiler pan and the insert (some models) allows grease to drain and be kept away from the high heat of the broiler. **DO NOT** use the pan without the insert. **DO NOT** cover the insert with **aluminum foil**; the exposed grease could ignite.
- To insure proper results when broiling use **ONLY** Electrolux Home Products, Inc. approved broil pan & insert.

NOTE

Always pull the oven rack out to the stop position before turning or removing the food.

Suggested broil settings table (gas oven)

Food	Rack position	Setting	Cook time in minutes		Doneness
			1st side	2nd side	
Steak 1" thick	5th or 6th*	Hi	8	6	Medium
Steak 1" thick	5th or 6th*	Hi	10	8	Medium-well
Steak 1" thick	5th or 6th*	Hi	11	10	Well
Pork chops 3/4" thick	5th	Hi	12	8	Well
Chicken-bone in	4th	Lo	25	15	Well
Chicken-boneless	5th	Lo	10	8	Well
Fish	5th	Hi	- as directed -	-	Well
Shrimp	4th	Hi	- as directed -	-	Well
Hamburger 1" thick	6th*	Hi	12	10	Medium
Hamburger 1" thick	5th	Hi	14	12	Well

*Use the off-set rack if you choose to use oven rack position 6 (if equipped).

Fig. 3

SETTING OVEN CONTROLS

Adjusting the oven temperature

Your appliance has been factory calibrated and tested to ensure an accurate baking temperature. For the first few uses, follow your recipe times and temperature recommendations carefully. If you think the oven is cooking too hot or too cool for your recipe times, you can adjust the control so the oven cooks hotter or cooler than the temperature displayed.

To adjust oven temperature:

1. Press **bake**.
2. Set the temperature to 550°F (287°C) by pressing and holding the **▲**.
3. Within 2 seconds, press and hold **bake** until numeric digit(s) appear. Release **bake** keypad. The display now indicates the amount of degrees offset between the original factory temperature setting and the current temperature setting. If the oven control has the original factory calibration, the display will read "0."
4. The temperature can now be adjusted up or down 35°F (19°C), in 5°F increments by pressing and holding the **▲** or **▼**. Adjust until the desired amount of offset appears in the display. When lowering the oven temperature, a minus sign (-) will appear before the number to indicate that the oven will be cooler by the displayed amount of degrees.
5. When you have made the desired adjustment, press **clear off** to go back to the time of day display.

NOTES

Oven temperature adjustments made will not affect the broil or self-cleaning feature temperatures.

If the display is set for Celsius, adjustments made will be in 1°C increments each press of the **▲** or **▼** keys.

DO NOT USE oven thermometers such as those found in grocery stores to check the temperature settings inside your oven. These oven thermometers may vary as much as 20 to 40 degrees from actual temperatures.

Setting oven lockout

The control can be programmed to lock the oven door and lockout the oven control pads.



To set the oven lockout feature

1. Press **clear off** and hold for 3 seconds. "Loc" will appear in display, the "Door Locked" indicator light will flash and the motor driven door lock will begin to close automatically. **Allow about 15 seconds** for the oven door to lock. Once the oven door is locked, the current time of day will appear in the display.
2. To cancel the Oven Lockout feature, press **clear off** and hold for 3 seconds. The control will unlock the oven door and resume normal operation.

NOTES

DO NOT open the oven door while the indicator light is flashing. Allow about 15 seconds for the oven door to lock. Once the oven door is locked, the current time of day will appear in the display.

If any control pad is pressed with the oven lockout feature active, "Loc" will appear in the display until the control pad is released.

Operating oven light (some models)

The interior oven light will automatically turn ON when the oven door is opened. Press the oven light switch located on the upper left control panel to turn the interior oven light ON and OFF whenever the oven door is closed.

The interior oven light is located at the upper left rear wall of the oven interior and is covered with a glass shield held by a wire holder. The glass shield must be in place whenever the oven is in use. To change the interior oven light, see "Changing the oven light" in the **Care & Cleaning** section.

oven light switch

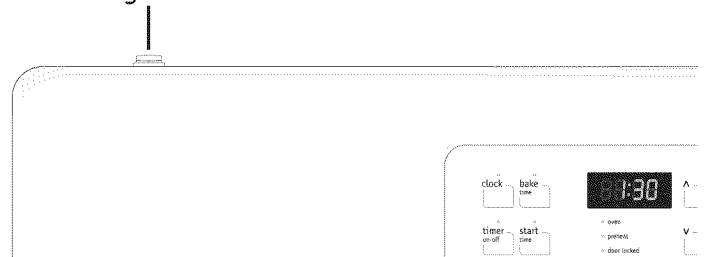

Self-cleaning

A self-cleaning oven cleans itself with high temperatures (well above normal cooking temperatures) which eliminate soils completely or reduces them to a fine powdered ash you can wipe away with a damp cloth.

➔ IMPORTANT

Adhere to the following self-clean precautions:

- **DO NOT** use oven cleaners or oven protective coatings in or around any part of the oven interior.
- **DO NOT** clean the oven door gasket (See Fig. 1). The woven material of the oven door gasket is essential for a good seal. Care should be taken not to rub, damage or remove the gasket.
- **DO NOT** use any cleaning materials on the oven door gasket. Doing so could cause damage.
- **Remove the broiler pan and insert, all utensils and ANY ALUMINUM FOIL. These items cannot withstand high cleaning temperatures and will melt.**
- **Completely remove ALL OVEN RACKS and ANY ACCESSORIES. If the oven racks are not removed they will lose their special coating properties and no longer slide in and out of the oven cavity easily.**
- **Remove any excessive spillovers.** Any spills on the oven bottom should be wiped-up and removed **before starting** the self-cleaning cycle. To clean, use hot, soapy water and a cloth. Large spillovers can cause heavy smoke or fire when subjected to high temperatures. **DO NOT** allow food spills with a high sugar or acid content (such as milk, tomatoes, sauerkraut, fruit juices or pie filling) to remain on the surface as they may leave a dull spot even after cleaning.
- Clean any soil from the oven frame, the door liner outside the oven door gasket and the small area at the front center of the oven bottom. These areas heat sufficiently to burn soil on. Clean with soap and water. These areas are shown in white (See Fig. 1).

⚠ CAUTION

During the self-cleaning cycle, the outside of the range can become very hot to the touch. **DO NOT** leave small children unattended near the appliance.

The health of some birds is extremely sensitive to the fumes given off during the Self-cleaning cycle of any range. Move birds to another well-ventilated room.

DO NOT force the oven door open. This can damage the automatic door locking system. Use caution when opening the door after the self-cleaning cycle is finished. The oven may still be **VERY HOT**.

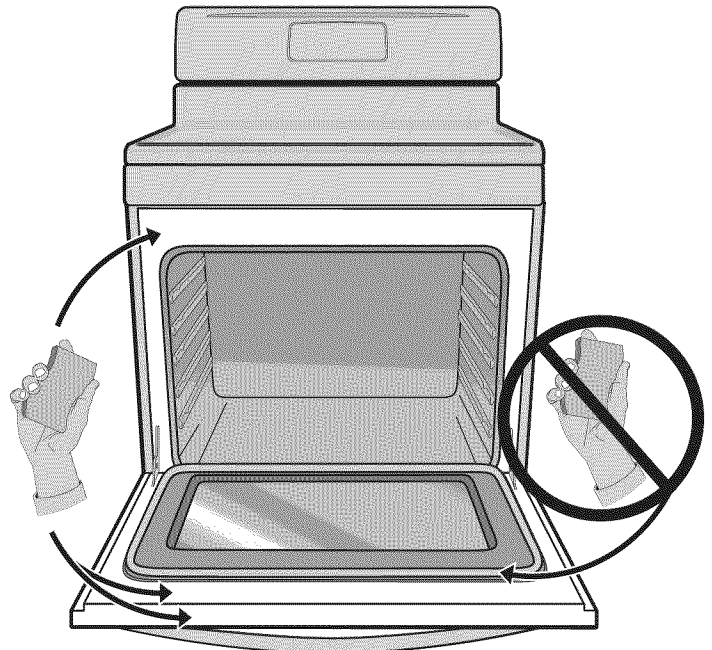

Fig. 1

SELF-CLEANING

Setting a self-clean cycle or a delayed start self-clean cycle

IMPORTANT

To start a self-clean cycle immediately without a **delay**, skip steps 2 & 3 in the instructions provided below.

Setting self-clean cycle

1. Be sure the clock displays the correct time of day.
2. Press **start time**. The " : " in the time of day will flash.
3. Press and hold the **▲** pad to scroll to the time to start the delayed self-clean cycle. Release the pad when the desired time is displayed.
4. Press **clean**. "----" appears in the display.
5. Press the **▲** or **▼** pad once. "3:00" will appear in the display indicating that a 3 hour self-clean time is set. To change to a 2 hour self-clean time press **▼** once (2:00 appears in the display).

(Some models) For a 4 hour self-clean time press **▲** until (4:00 appears in display).
6. "CLn" will appear in the display during the self-clean cycle and the "LOCK" light will glow until the self-cleaning cycle is complete or cancelled and the oven temperature has cooled.

NOTE

As soon as the controls are set, the motor driven lock will begin to close automatically and the "LOCK" indicator light will flash. **DO NOT** open the oven door while the light is flashing (allow about 15 seconds for the oven door to lock).

When the self-clean cycle has completed:

1. The time of day will appear in the display window and the "Clean" and "LOCK" light will continue to glow.
2. Once the oven has cooled down for about 1 HOUR and the "LOCK" light has gone out, the oven door can be opened.

Stopping or interrupting a self-clean cycle

If it becomes necessary to stop or interrupt a self-cleaning cycle once it has been activated

1. Press **clear off**.
2. Once the oven has cooled down for about 1 HOUR and the "LOCK" light has turned off, the oven door can be opened.
3. Restart self-clean cycle once all conditions have been corrected.

CAUTION

To avoid possible burns use care when opening the oven door after the self-cleaning cycle. **Stand to the side of the oven** when opening the door to allow hot air or steam to escape.

DO NOT force the oven door open. This can damage the automatic door locking system. Use caution and avoid possible burns when opening the door after the self-cleaning cycle has completed. The oven may still be **VERY HOT**.

NOTES

Whenever the self-clean feature is active you may check the amount of time remaining by pressing the **clean** pad. Remember the range door cannot be opened until the range has cooled sufficiently. You will need to **add about 1 hour to the time** displayed before you can use the range for cooking.

When the oven is cool, wipe away any residue or powdered ash with a damp cloth or paper towel.

Cleaning recommendation table

Surface type	Recommendation
<ul style="list-style-type: none"> • Control knobs • Painted body parts • Painted decorative trim • Aluminum, plastic or vinyl trim pieces 	<p>Use hot, soapy water and a cloth. Dry with a clean cloth.</p> <p><i>For general cleaning, use hot, soapy water and a cloth. For more difficult soils and built-up grease, apply a liquid detergent directly onto the soil. Leave on soil for 30 to 60 minutes. Rinse with a damp cloth and dry. Do not use abrasive cleaners on any of these materials; they can scratch. To remove control knobs, turn to the OFF position; grasp firmly and pull straight off the shaft. To replace knobs after cleaning, line up the flat sides of both the knob and the shaft; then push the knob into place.</i></p>
<ul style="list-style-type: none"> • Control panel • Decorative trim (some models) 	<p><i>Before cleaning the control panel, turn all controls OFF and if needed remove any knobs from the panel. Clean using hot, soapy water and a dishcloth. Be sure to squeeze excess water from the dishcloth before wiping the control panel; especially when wiping around the controls area. Excess water in or around the controls may cause damage to the appliance. When rinsing, use clean water and a dishcloth and be sure to squeeze excess water from dishcloth before wiping the control panel.</i></p>
<ul style="list-style-type: none"> • Stainless Steel (some models) 	<p>Clean heavier soils with hot, soapy water and a dishcloth. Rinse with clean water and a cloth. Do not use cleaners with high concentrations of chlorides or chlorine. Do not use harsh scrubbing cleaners. Only use kitchen cleaners that are especially made for cleaning stainless steel. Always be sure to wipe the cleaners off from the surface as bluish stains may occur during heating that cannot be removed.</p>
<ul style="list-style-type: none"> • Porcelain enamel broiler pan and broiler pan insert (if equipped) • Door liner & body parts 	<p>Gentle scouring with a soapy non-abrasive scouring pad will remove most spots. Rinse with a 1:1 solution of clear water and ammonia. <i>If necessary, cover difficult spots with an ammonia-soaked paper towel for 30 to 40 minutes. Rinse with clean water and a damp cloth, and then scrub with a soap-filled non-abrasive scouring pad. Rinse and wipe dry with a clean cloth. Remove all cleaners or the porcelain may become damaged during future heating.</i></p>
<ul style="list-style-type: none"> • Oven racks 	<p>Oven racks must be removed from oven before starting self-clean cycle. Clean by using a mild, abrasive cleaner following manufacturer's instructions. Rinse with clean water and dry.</p>
<ul style="list-style-type: none"> • Oven door 	<p>Use soap & water to thoroughly clean the top, sides and front of the oven door. Rinse well. You may use a glass cleaner on the outside glass of the oven door. Do not immerse the door in water. Do not spray or allow water or the glass cleaner to enter the door vents. Do not use oven cleaners, cleaning powders or any harsh abrasive cleaning materials on the outside of the oven door.</p> <p>Do not clean the oven door gasket. On self-cleaning models the oven door gasket is made of a woven material which is essential for a good seal. Care should be taken not to rub, damage or remove this gasket.</p>
<ul style="list-style-type: none"> • Cooktop surface and contoured well areas, surface burner heads and caps 	<p>Do not use spray oven cleaners on the cooktop. See Cleaning the cooktop and surface burner instructions provided in the Care & Cleaning section.</p>

CARE & CLEANING

Cleaning the cooktop and surface burners

CAUTION

- To avoid possible burns **DO NOT** attempt any of the cleaning instructions provided below before turning OFF all of the surface burners and allow them to cool.
- Any additions, changes or conversions required in order for this appliance to satisfactorily meet the application needs must be made by an authorized qualified Agency.

Routinely clean the cooktop. Wipe with a clean, damp cloth and wipe dry to avoid scratches.

Keeping the surface burner head ports and slots clean will prevent improper ignition and an uneven flame. See the following sections for more instructions.

To clean recessed and contoured areas of cooktop

If a spill occurs on or in the recessed or contoured areas, blot up spill with an absorbent cloth. Rinse with a clean, damp cloth and wipe dry.

To clean burner grates

- Clean when the grates are cool.
- Use nonabrasive plastic scrubbing pad and mild abrasive cleanser.
- Food soils containing acids may affect the finish. Clean immediately after the grates are cool.
- Thoroughly dry grates immediately following cleaning.

To clean burner caps

- Remove caps from burner heads after they have cooled.
- Clean heavy soils with a plastic scrubbing pad and absorbent cloth.
- Thoroughly dry burner caps immediately following cleaning including the bottom and inside of cap.
- Do not use abrasive cleaners. They can scratch porcelain.
- Do not clean burner caps in the dishwasher.
- Do not operate surface burners without burner caps properly in place. See **IMPORTANT** notes.

IMPORTANT

- **Always** keep the surface burner caps in place whenever a surface burner is in use.
- When replacing the burner caps, be sure the **burner caps** are **seated firmly** on top of the burner heads.
- The surface burner heads are secured to the cooktop and must be cleaned in place on the cooktop.
- For proper flow of gas and ignition of burners — **DO NOT allow spills, food, cleaning agents or any other material to enter the gas orifice opening.**

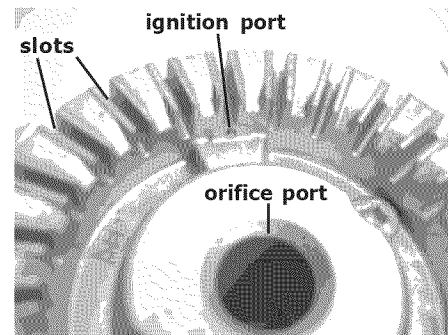

Fig. 1 - Cooktop burner head

To clean the surface burner heads

For proper gas flow it may be necessary to clean the burner head and slots. To clean, first use a clean DAMP cloth to soak up any spills. Remove any food from between the burner slots using a small nonabrasive brush like a toothbrush and afterwards wipe up using a damp cloth. For stubborn soils located in the slots, use a small-gauge wire or needle to clean.

Any spill on or around the electrode must be carefully cleaned. Take care not to hit the electrode with anything hard or it could be damaged.

To clean the burner head ignition ports

Each burner head has a small ignition port located as illustrated. Should you experience ignition problems it may be that this port hole is partially blocked with soil. With the burner head in place, use a small wire gauge needle or the end of a paper clip to clear the ignition port (See Fig. 1 - center burner not shown).

Replacing oven light

CAUTION

Be sure the range is unplugged and all parts are COOL before replacing oven light. Wear a leather-faced glove for protection against possible broken glass.

The light bulb is located at the rear of the oven cavity and is covered with a glass shield held by a wire holder. The glass shield must be in place whenever the oven is in use.

To replace the oven light bulb:

1. Turn electrical power off at the main source or unplug the range.
2. Press wire holder to one side to release the glass shield that covers the light bulb.
3. Replace bulb with a new 40 watt appliance bulb.
4. Replace glass shield over bulb and snap wire holder back into place.
5. Turn power back on again at the main source (or plug the appliance back in).
6. The clock will then need to be reset. To reset, see "Setting the clock" in this Use & Care Guide.

Special door care instructions - Most oven doors contain glass that can break. Read the following recommendations:

- Do not close the oven door until all the oven racks are fully in place.
- Do not hit the glass with pots, pans, or any other object.
- Scratching, hitting, jarring or stressing the glass may weaken its structure causing an increased risk of breakage at a later time.

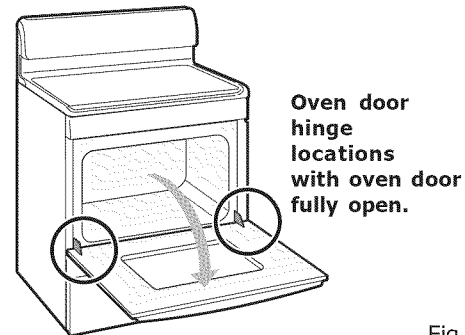

Fig. 1

Removing and replacing the lift-off oven door

CAUTION

The oven door is heavy. For safe, temporary storage, lay the oven door flat with the inside of the door facing down.

To remove oven door:

1. Open oven door completely (horizontal with floor - Fig.1).
2. Pull the door hinge locks on both left and right door hinges down from the oven frame completely towards the oven door (Fig. 2). A tool such as a small flat-blade screwdriver may be required.
3. Firmly grasp both sides of oven door along the door sides (Do not use the oven door handle - Fig. 3).
4. Close the door to the broil stop position (the oven door will stop into this position just before fully closing).
5. With the oven door in the broil stop position, lift the oven door hinge arms over the roller pins located on each side of the oven frame (Fig. 4).

To replace oven door:

1. Firmly grasp both sides of oven door along the door sides (Do not use the oven door handle - Fig. 3).
2. Holding the oven door at the same angle as the removal position, seat the hook of the hinge arm over the roller pins located on each side of the oven door frame (Fig. 4). The hook of the hinge arms must be fully seated onto the roller pins.
3. Fully open the oven door (horizontal with floor - Fig. 1).
4. Push the door hinge locks up towards and into the oven frame on both left and right oven door hinges (Fig. 2) to the locked position; then close the oven door.

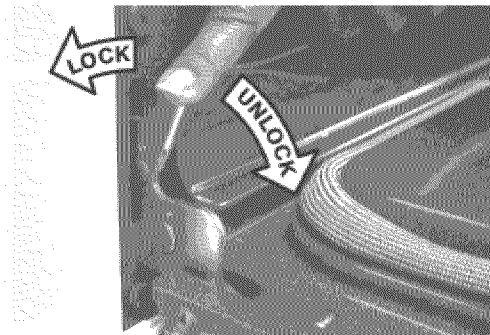

Fig. 2

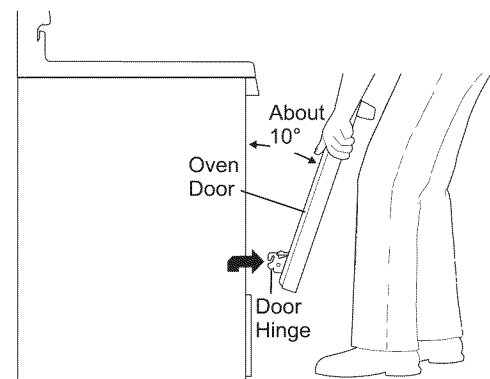

Fig. 3

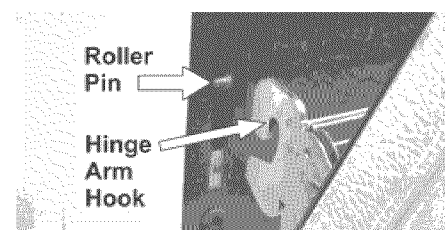

Fig. 4

BEFORE YOU CALL • Solutions to common problems

Problem	Solution
Poor baking results.	<ul style="list-style-type: none">• Many factors affect baking results. Make sure the proper oven rack position is used. Center food in the oven and space pans to allow air to circulate. Allow the oven to preheat to the set temperature before placing food in the oven. Try adjusting the recipe's recommended temperature or baking time. If you feel the oven is too hot or cool, see "Adjusting the oven temperature" section in this Use & Care Guide.
Entire appliance does not operate.	<ul style="list-style-type: none">• The time of day is not set. The time of day must first be set in order to operate the oven. See "Setting the clock" in the Setting Oven Controls section.• Make sure cord/plug is plugged correctly into outlet.• Service wiring not complete. Contact your dealer, installing agent or authorized service agent.• Electrical power outage. Check house lights to be sure. Call your local electric company for service.
Oven portion of appliance does not operate.	<ul style="list-style-type: none">• Be sure the oven controls are set properly for the desired cooking feature. See Setting Oven Controls in this manual or see "Entire appliance does not operate" in this checklist.
Surface burners do not ignite.	<ul style="list-style-type: none">• Surface control knob was not completely turned to LITE. Push in & turn the surface control knob to LITE until burner ignites and then turn control knob to desired flame size.• Burner ports are clogged. With the burner OFF, use a small-gauge wire or needle to burner head slots and ignition ports. See "Cleaning the cooktop and surface burners" in the Care & Cleaning section for additional cleaning instructions.• Range power cord is disconnected from outlet (electric ignition models only). Be sure power cord is securely plugged into the power outlet.• Electrical power outage (electric ignition models only). Burners can be lit manually. See section on Setting Surface Controls.
Surface burner flame only part way around burner cap.	<ul style="list-style-type: none">• Burner slots or ports are clogged. With the surface burner OFF, clean ports with a small-gauge wire or needle.• Moisture is present after cleaning. Lightly fan the flame & allow burner to operate until flame is full. Dry the surface burners thoroughly following the instructions under "Cleaning the cooktop and surface burners" provided in the Care & Cleaning section.
Surface burner flame is orange.	<ul style="list-style-type: none">• Dust particles in main gas line. Allow the burner to operate a few minutes until flame turns blue. In coastal areas, a slightly orange flame is unavoidable due to salt air.
Self-cleaning cycle does not work.	<ul style="list-style-type: none">• Oven control not set properly. Follow instructions under Self-Cleaning.• Self-cleaning cycle was interrupted. Follow steps under "Stopping or interrupting a self-cleaning cycle" under Self-Cleaning.

Problem	Solution
Soil not completely removed after self-cleaning cycle.	<ul style="list-style-type: none">• Failure to clean bottom, front top of oven, frame of oven or door area outside oven seal. These areas are not in the self-cleaning area, but get hot enough to burn on residue. Clean these areas before the self-cleaning cycle is started. Burned-on residue can be cleaned with a stiff nylon brush and water or a nylon scrubber. Be careful not to damage the oven gasket.
Oven smokes excessively during broiling.	<ul style="list-style-type: none">• Incorrect setting. Follow broiling instructions in Setting Oven Controls.• Make sure oven door closed.• Meat too close to upper burner. Reposition oven rack to provide proper clearance between the meat & the burner. Preheat the oven.• Meat not properly prepared. Remove excess fat from meat. Cut remaining fatty edges to prevent curling, but do not cut into lean.• Broiler pan and insert wrong side up and grease not draining. Always place insert on the broiler pan with ribs up & slots down to allow grease to drip into pan (some models).• Grease has built up on oven surfaces. Regular cleaning is necessary when broiling frequently. Old grease or food spatters cause excessive smoking.
Flames inside oven or smoking from oven vent.	<ul style="list-style-type: none">• Excessive spillovers in oven. For example this will happen for pie spillovers or large amounts of grease left on the oven bottom. Wipe up excessive spillovers before starting oven. If flames or excessive smoke are present see "Broiling" in the Setting Oven Controls section.
Oven control panel beeps & displays any F code error (for example F10, F11, F13, F14, F15, F30, F31 or F90).	<ul style="list-style-type: none">• Oven control has detected a fault or error condition. Press clear off to clear the display & stop beeping. Try the bake or broil feature again. If the F code error repeats, remove power from appliance, wait 5 minutes and then repower appliance and set clock for the time of day. Try the bake or broil feature again. If the fault recurs, record fault and call for service.
Oven light does not work.	<ul style="list-style-type: none">• Be sure the light is secure in the socket. Also see "Replacing oven light" in the Care & Cleaning section.
Appliance is not level.	<ul style="list-style-type: none">• Be sure floor is level, strong & stable enough to adequately support range.• If floor is sagging or sloping, contact a carpenter to correct the situation.• Poor installation. Place oven rack in center of oven. Place a level on the oven rack. Adjust leveling legs at base of appliance until the rack is level.• Kitchen cabinet alignment may make range appear not level. Be sure cabinets are square & have sufficient room for appliance clearance.
Cannot move appliance easily. Appliance must be accessible for service.	<ul style="list-style-type: none">• Cabinets not square or are built in too tightly. Contact builder or installer to make appliance accessible.• Carpet interferes with appliance. Provide sufficient space so appliance can be lifted over carpet.

MAJOR APPLIANCE WARRANTY

Your appliance is covered by a one year limited warranty. For one year from your original date of purchase, Electrolux will pay all costs for repairing or replacing any parts of this appliance that prove to be defective in materials or workmanship when such appliance is installed, used and maintained in accordance with the provided instructions.

Exclusions

This warranty does not cover the following:

1. Products with original serial numbers that have been removed, altered or cannot be readily determined.
2. Product that has been transferred from its original owner to another party or removed outside the USA or Canada.
3. Rust on the interior or exterior of the unit.
4. Products purchased "as-is" are not covered by this warranty.
5. Food loss due to any refrigerator or freezer failures.
6. Products used in a commercial setting.
7. Service calls which do not involve malfunction or defects in materials or workmanship, or for appliances not in ordinary household use or used other than in accordance with the provided instructions.
8. Service calls to correct the installation of your appliance or to instruct you how to use your appliance.
9. Expenses for making the appliance accessible for servicing, such as removal of trim, cupboards, shelves, etc., which are not a part of the appliance when it is shipped from the factory.
10. Service calls to repair or replace appliance light bulbs, air filters, water filters, other consumables, or knobs, handles, or other cosmetic parts.
11. Surcharges including, but not limited to, any after hour, weekend, or holiday service calls, tolls, ferry trip charges, or mileage expense for service calls to remote areas, including the state of Alaska.
12. Damages to the finish of appliance or home incurred during installation, including but not limited to floors, cabinets, walls, etc.
13. Damages caused by: services performed by unauthorized service companies; use of parts other than genuine Electrolux parts or parts obtained from persons other than authorized service companies; or external causes such as abuse, misuse, inadequate power supply, accidents, fires, or acts of God.

DISCLAIMER OF IMPLIED WARRANTIES; LIMITATION OF REMEDIES

CUSTOMER'S SOLE AND EXCLUSIVE REMEDY UNDER THIS LIMITED WARRANTY SHALL BE PRODUCT REPAIR OR REPLACEMENT AS PROVIDED HEREIN. CLAIMS BASED ON IMPLIED WARRANTIES, INCLUDING WARRANTIES OF MERCHANTABILITY OR FITNESS FOR A PARTICULAR PURPOSE, ARE LIMITED TO ONE YEAR OR THE SHORTEST PERIOD ALLOWED BY LAW, BUT NOT LESS THAN ONE YEAR. ELECTROLUX SHALL NOT BE LIABLE FOR CONSEQUENTIAL OR INCIDENTAL DAMAGES SUCH AS PROPERTY DAMAGE AND INCIDENTAL EXPENSES RESULTING FROM ANY BREACH OF THIS WRITTEN LIMITED WARRANTY OR ANY IMPLIED WARRANTY. SOME STATES AND PROVINCES DO NOT ALLOW THE EXCLUSION OR LIMITATION OF INCIDENTAL OR CONSEQUENTIAL DAMAGES, OR LIMITATIONS ON THE DURATION OF IMPLIED WARRANTIES, SO THESE LIMITATIONS OR EXCLUSIONS MAY NOT APPLY TO YOU. THIS WRITTEN WARRANTY GIVES YOU SPECIFIC LEGAL RIGHTS. YOU MAY ALSO HAVE OTHER RIGHTS THAT VARY FROM STATE TO STATE.

If You Need Service

Keep your receipt, delivery slip, or some other appropriate payment record to establish the warranty period should service be required. If service is performed, it is in your best interest to obtain and keep all receipts. Service under this warranty must be obtained by contacting Electrolux at the addresses or phone numbers below.

This warranty only applies in the USA and Canada. In the USA, your appliance is warranted by Electrolux Major Appliances North America, a division of Electrolux Home Products, Inc. In Canada, your appliance is warranted by Electrolux Canada Corp. Electrolux authorizes no person to change or add to any obligations under this warranty. Obligations for service and parts under this warranty must be performed by Electrolux or an authorized service company. Product features or specifications as described or illustrated are subject to change without notice.

USA
1.800.944.9044
Electrolux Major Appliances
North America
P.O. Box 212378
Augusta, GA 30907



Canada
1.800.265.8352
Electrolux Canada Corp.
5855 Terry Fox Way
Mississauga, Ontario, Canada
L5V 3E4