



Built-In Gas Cooktops

Safety Instructions 2-6

Operating Instructions

Control Lock7
Cookware8
Dual Stack Burner7
Flame Size8
Lighting a Burner7
PowerBoil™ Burner7
Sealed Gas Burners7

Care and Cleaning

Burners and
Cooktop Electrodes10
Burner Bases10
Burner Caps and Heads10
Burner Grates11
Burner Head and
Cap Replacement11
Control Knobs9
Electrodes10
Glass Cooktop12, 13
Porcelain Enamel Cooktop ...9
Shipping Film and Tape9
Stainless Steel Surfaces9

Troubleshooting Tips ...14, 15

Consumer Support

Consumer Support 24
Product Registration (Canada) 19
Product Registration (U.S.) ...17
Warranty (Canada)23
Warranty (U.S.)22

Write the model and serial numbers here:

Model # _____

Serial # _____

You can find them on a label under the cooktop.

Owner's Manual

- JGP328
- JGP330
- JGP628
- JGP630
- JGP933
- JGP940
- JGP945
- JGP963
- JGP970
- JGP975

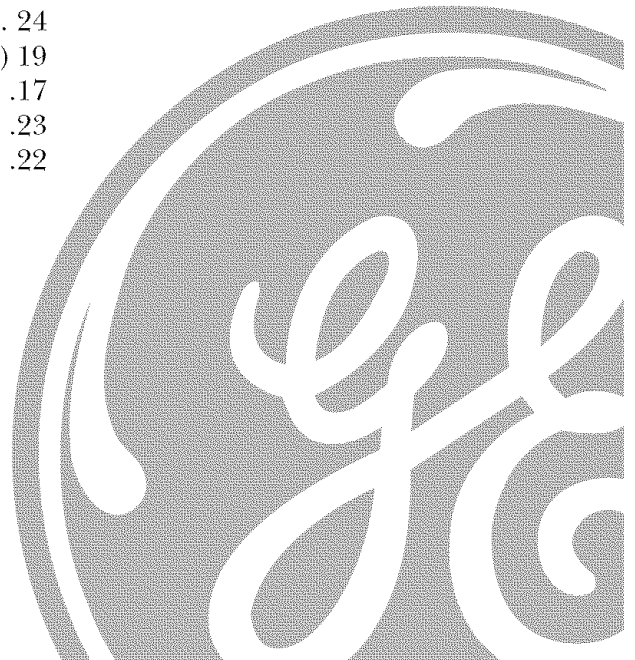

IMPORTANT SAFETY INFORMATION. READ ALL INSTRUCTIONS BEFORE USING.

WARNING: If the information in this manual is not followed exactly, a fire or explosion may result causing property damage, personal injury or death.

- Do not store or use gasoline or other flammable vapors and liquids in the vicinity of this or any other appliance.
- **WHAT TO DO IF YOU SMELL GAS**
 - Do not try to light any appliance.
 - Do not touch any electrical switch; do not use any phone in your building.
 - Immediately call your gas supplier from a neighbor's phone. Follow the gas supplier's instructions.
 - If you cannot reach your gas supplier, call the fire department.
- Installation and service must be performed by a qualified installer, service agency or the gas supplier.



⚠ WARNING!

For your safety, the information in this manual must be followed to minimize the risk of fire or explosion, electric shock, or to prevent property damage, personal injury, or loss of life.

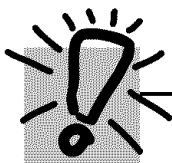

IMPORTANT SAFETY NOTICE

The California Safe Drinking Water and Toxic Enforcement Act requires the Governor of California to publish a list of substances known to the state to cause cancer, birth defects or other reproductive harm, and requires businesses to warn customers of potential exposure to such substances.

Gas appliances can cause minor exposure to four of these substances, namely benzene, carbon monoxide, formaldehyde and soot, caused primarily by the incomplete combustion of natural gas or LP fuels. Properly adjusted burners, indicated by a bluish rather than a yellow flame, will minimize incomplete combustion. Exposure to these substances can be minimized by venting with an open window or using a ventilation fan or hood.

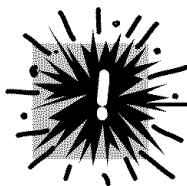

SAFETY PRECAUTIONS

Have the installer show you the location of the cooktop gas shut-off valve and how to shut it off if necessary.

- Have your cooktop installed and properly grounded by a qualified installer, in accordance with the Installation Instructions. Any adjustment and service should be performed only by qualified gas cooktop installers or service technicians.
- Do not attempt to repair or replace any part of your cooktop unless it is specifically recommended in this manual. All other service should be referred to a qualified technician.
- Locate the cooktop out of kitchen traffic path and out of drafty locations to prevent pilot outage and poor air circulation.
- Plug your cooktop into a 120-volt grounded outlet only. Do not remove the round grounding prong from the plug. If in doubt about the grounding of the home electrical system, it is your personal responsibility and obligation to have an ungrounded outlet replaced with a properly grounded, three-prong outlet in accordance with the National Electrical Code. Do not use an extension cord with this appliance.
- Let the burner grates and other surfaces cool before touching them or leaving them where children can reach them.
- Be sure all packaging materials are removed from the cooktop before operating it to prevent fire or smoke damage should the packaging material ignite.
- Be sure your cooktop is correctly adjusted by a qualified service technician or installer. This counter unit, as shipped from the factory, can only be operated with natural gas. Do not try to operate it with LP (bottled) gas unless you follow the Installation Instructions packed with your cooktop. See LP Conversion Instructions.

IMPORTANT SAFETY INFORMATION. READ ALL INSTRUCTIONS BEFORE USING.

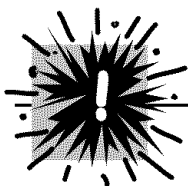

SAFETY PRECAUTIONS

- Do not leave children alone or unattended where a cooktop is hot or in operation. They could be seriously burned.
 - Do not allow anyone to climb, stand or hang on the cooktop.
 - **CAUTION:** Items of interest to children should not be stored in cabinets above a cooktop—children climbing on the cooktop to reach items could be seriously injured.
- ▲ WARNING: NEVER** use this appliance as a space heater to heat or warm the room. Doing so may result in carbon monoxide poisoning and overheating of the cooktop.
- Always keep wooden and plastic utensils and canned food a safe distance away from your cooktop.
 - Always keep combustible wall coverings, curtains or drapes a safe distance from your cooktop.
 - Never wear loose-fitting or hanging garments while using the appliance. Be careful when reaching for items stored in cabinets over the cooktop. Flammable material could be ignited if brought in contact with flame or hot surfaces and may cause severe burns.
 - Teach children not to play with the controls or any other part of the cooktop.
 - For your safety, never use your appliance for warming or heating the room.
 - Always keep dish towels, dishcloths, pot holders and other linens a safe distance from your cooktop.
 - Do not store flammable materials near a cooktop.
 - Do not store or use combustible materials, gasoline or other flammable vapors and liquids in the vicinity of this or any other appliance.
 - Do not let cooking grease or other flammable materials accumulate near the cooktop.
 - Do not operate the burner without all burner parts in place.
 - Do not clean the cooktop with flammable or volatile cleaning fluids.
 - Do not clean the cooktop when the appliance is in use.
 - Avoid scratching the cooktop with sharp instruments, or with rings and other jewelry.
 - Never use the cooktop as a cutting board.
 - Do not use water on grease fires. Never pick up a flaming pan. Turn the controls off. Smother a flaming pan on a surface burner by covering the pan completely with a well-fitting lid, cookie sheet or flat tray. Use a multi-purpose dry chemical or foam-type fire extinguisher.
- Flaming grease outside a pan can be put out by covering it with baking soda or, if available, by using a multi-purpose dry chemical or foam-type fire extinguisher.

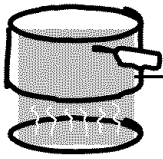

⚠ WARNING! SURFACE BURNERS

Use proper pan size—avoid pans that are unstable or easily tipped. Select cookware having flat bottoms large enough to cover burner grates. To avoid spillovers, make sure cookware is large enough to contain the food properly. This will both save cleaning time and prevent hazardous accumulations of food, since heavy spattering or spillovers left on cooktop can ignite. Use pans with handles that can be easily grasped and remain cool.

- Always use the **LITE** position when igniting the top burners and make sure the burners have ignited.
- Never leave the surface burners unattended at high flame settings. Boilovers cause smoking and greasy spillovers that may catch on fire.
- Use only dry pot holders—moist or damp pot holders on hot surfaces may result in burns from steam. Do not let pot holders come near open flames when lifting cookware. Do not use a towel or other bulky cloth in place of a pot holder. Such cloths can catch fire on a hot burner.
- When using glass cookware, make sure it is designed for cooktop cooking.
- To minimize the possibility of burns, ignition of flammable materials and spillage, turn cookware handles toward the side or back of the cooktop without extending over adjacent burners.
- Always turn the surface burner controls off before removing cookware.
- Carefully watch foods being fried at a high flame setting.
- Always heat fat slowly, and watch as it heats.
- Do not leave any items on the cooktop. The hot air from the vent may ignite flammable items and will increase pressure in closed containers, which may cause them to burst.
- If a combination of oils or fats will be used in frying, stir together before heating or as fats melt slowly.
- Do not use a wok on the cooking surface if the wok has a round metal ring that is placed over the burner grate to support the wok. This ring acts as a heat trap, which may damage the burner grate and burner head. Also, it may cause the burner to work improperly. This may cause a carbon monoxide level above that allowed by current standards, resulting in a health hazard.
- Foods for frying should be as dry as possible. Frost on frozen foods or moisture on fresh foods can cause hot fat to bubble up and over the sides of the pan.
- Use the least possible amount of fat for effective shallow or deep-fat frying. Filling the pan too full of fat can cause spillovers when food is added.
- Use a deep fat thermometer whenever possible to prevent overheating fat beyond the smoking point.
- Never try to move a pan of hot fat, especially a deep-fat fryer. Wait until the fat is cool.
- When preparing flaming foods under the hood, turn the fan on.
- Do not leave plastic items on the cooktop—they may melt if left too close to the vent.
- Keep all plastics away from the surface burners.
- If you smell gas, turn off the gas to the cooktop and call a qualified service technician. Never use an open flame to locate a leak.
- To avoid the possibility of a burn, always be certain that the controls for all burners are at the off position and all grates are cool before attempting to remove them.

IMPORTANT SAFETY INFORMATION. READ ALL INSTRUCTIONS BEFORE USING.



SURFACE BURNERS

Adjust the top burner flame size so it does not extend beyond the edge of the cookware. Excessive flame is hazardous.

- Clean the cooktop surface with caution. If a wet sponge or cloth is used to wipe spills on a hot surface, be careful to avoid steam burns. Some cleaners can produce noxious fumes if applied to a hot surface.

NOTE: We recommend that you avoid wiping any surface areas until they have cooled. Sugar spills are the exception to this. Please see *Cleaning the glass cooktop surface* section.
- When the cooktop is cool, use only CERAMA BRYTE® Ceramic Cooktop Cleaner and the CERAMA BRYTE® Cleaning Pad to clean the cooktop.
- To avoid possible damage to the cooking surface, do not apply cleaning cream to the glass surface when it is hot.
- After cleaning, use a dry cloth or paper towel to remove all cleaning cream residue.
- Read and follow all instructions and warnings on the cleaning cream labels.
- Never clean the cooktop surface when it is hot. Some cleaners produce noxious fumes and wet cloths could cause steam burns if used on a hot surface.
- Never leave jars or cans of fat drippings on or near your cooktop.
- Don't use aluminum foil to line burner bowls. Misuse could result in a fire hazard or damage to the cooktop.
- Do not cover or block the area around the cooktop knobs. This area must be kept clear for proper ventilation and burner performance.
- Large scratches or impacts to glass cooktops can lead to broken or shattered glass.
- Clean only parts listed in this Owner's Manual.



COOK MEAT AND POULTRY THOROUGHLY...

Cook meat and poultry thoroughly—meat to at least an INTERNAL temperature of 160°F and poultry to at least an INTERNAL temperature of 180°F. Cooking to these temperatures usually protects against foodborne illness.

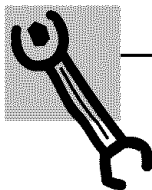

LP CONVERSION KIT

Your cooktop is shipped from the factory set to operate only with Natural Gas.

If you wish to use your cooktop with Liquefied Petroleum Gas, you must follow the Installation Instructions packed with your cooktop. See LP Conversion Instructions. This conversion must be performed by a qualified technician.



**READ AND FOLLOW THIS SAFETY INFORMATION CAREFULLY.
SAVE THESE INSTRUCTIONS**

Using the cooktop burners.

ge.com

Throughout this manual, features and appearance may vary from your model.

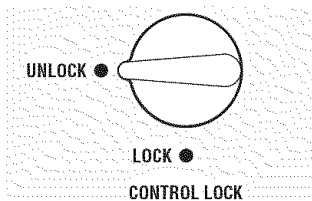

Control Lock (on some models)

To lock the cooktop and prevent unwanted use, turn the control lock knob counterclockwise to **LOCK**. An indicator light will glow to show that the cooktop is locked.

When locked, the cooktop will sound if any control knob is set to any position other than **OFF**.

To unlock, turn the control lock knob to **UNLOCK**.

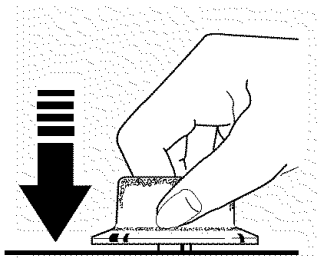

How to Light a Burner

Make sure the control lock knob is in the **UNLOCK** position.

Your cooktop burners are lit by electric ignition, eliminating the need for standing pilot lights with constantly burning flames.

Push the control knob down and turn it to the **LITE** position. After the burner ignites, turn the knob to adjust the flame size. To turn the burner off, turn the knob clockwise as far as it will go, to the **OFF** position.

■ Check to be sure the burner you turn on is the one you want to use.

■ Be sure you turn the control knob to **OFF** when you finish cooking.

■ In case of a power failure, you can light the burners with a match. Hold a lit match to the burner; then push in and turn the control knob to the **LITE** position. Use extreme caution when lighting burners this way. Burners in use when an electrical power failure occurs will continue to operate normally.

■ Do not operate the burner for an extended period of time without cookware on the grate. The finish on the grate may chip without cookware to absorb the heat.

■ Be sure the burners and grates are cool before you place your hand, a pot holder, cleaning cloths or other materials on them.

Sealed Gas Burners

The smallest burner in the right rear and the center burner (on some models) are the simmer burners. These burners can be turned down to **LO** or **SIMMER** (depending on model) for a very low setting. They provide precise cooking performance for delicate foods such as sauces or foods that require low heat for a long cooking time.

The medium (left rear) and the large (left front) burners are the general-purpose burners that can be turned down from **HI** to **LO** to suit a wide range of cooking needs.

Dual Stack Burner (on some models)

The extra large right front burner has maximum heating and precise simmer capability. It can be turned down from **PowerBoil™** to **SIMMER** for a wide range of cooking applications.

PowerBoil™ Burner (on some models)

The extra large right front burner has special **PowerBoil™** settings. This feature should only be used with cookware 11" or larger in diameter, and flames should

never be allowed to extend up the sides of the cookware. This feature is designed to quickly bring large amounts of liquid in pots 11" or larger in diameter to a boil.

Safety Instructions

Operating Instructions

Care and Cleaning

Troubleshooting Tips

Consumer Support

Using the cooktop burners.

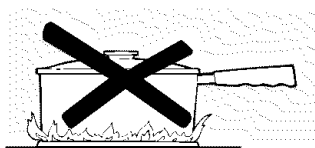

How to Select Flame Size

For safe handling of cookware, never let the flames extend up the sides of the cookware.

Watch the flame, not the knob, as you reduce heat. The flame size on a gas burner should match the cookware you are using.

Any flame larger than the bottom of the cookware is wasted and only serves to heat the handle.



Use a flat-bottomed wok.

Wok This Way

We recommend that you use a 14-inch or smaller flat-bottomed wok. They are available at your local retail store.

Only a flat-bottomed wok should be used. Make sure the wok bottom sits flat on the grate.

Do not use a wok support ring. Placing the ring over the burner or grate may cause the burner to work improperly, resulting in carbon monoxide levels above allowable standards. This could be dangerous to your health.

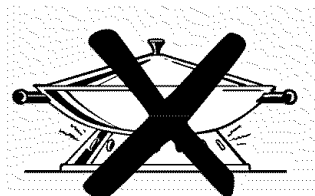

Cookware

Aluminum: Medium-weight cookware is recommended because it heats quickly and evenly. Most foods brown evenly in aluminum cookware. Use saucepans with tight-fitting lids when cooking with minimum amounts of water.

Enamelware: Under some conditions, the enamel of some cookware may melt. Follow cookware manufacturer's recommendations for cooking methods.

Glass: There are two types of glass cookware: those for oven use only and those for cooktop cooking (saucepans, coffee and tea pots). Glass conducts heat very slowly.

Cast Iron: If heated slowly, most cookware will give satisfactory results.

Heatproof Glass-Ceramic: Can be used for either surface or oven cooking. It conducts heat very slowly and cools very slowly. Check cookware manufacturer's directions to be sure it can be used on a gas cooktop.

Stainless Steel: This metal alone has poor heating properties and is usually combined with copper, aluminum or other metals for improved heat distribution. Combination metal cookware usually works satisfactorily if it is used with medium heat as the manufacturer recommends.

Home Canning Tips

Be sure the canner is centered over the burner.

To prevent burns from steam or heat, use caution when canning.

Use recipes and procedures from reputable sources. These are available from manufacturers such as Ball® and Keri® and the Department of Agriculture Extension Service.

Care and cleaning of the cooktop.

ge.com

Be sure electrical power is off and all surfaces are cool before cleaning any part of the cooktop.

How to Remove Protective Shipping Film and Packaging Tape

Carefully grasp a corner of the protective shipping film with your fingers and slowly peel it from the appliance surface. Do not use any sharp items to remove the film. Remove all of the film before using the appliance for the first time.

To assure no damage is done to the finish of the product, the safest way to remove the adhesive left from packaging tape on new appliances is an application of a household liquid dishwashing detergent. Apply with a soft cloth and allow to soak.

NOTE: The adhesive must be removed from all parts before using the cooktop. It cannot be removed if it is baked on.

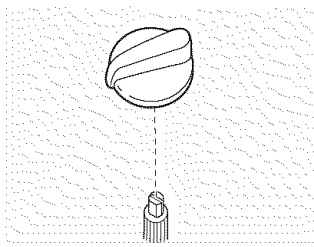

Control Knobs

The control knobs may be removed for easier cleaning.

Make sure the knobs are in the **OFF** positions and pull them straight off the stems for cleaning.

The knobs can be cleaned in a dishwasher or they may also be washed with soap and water. Make sure the insides of the knobs are dry before replacing.

Replace the knobs in the **OFF** position to ensure proper placement.

Pull the knob straight up off the stem.

Porcelain Enamel Cooktop (on some models)

The porcelain enamel finish is sturdy but breakable if misused. This finish is acid-resistant. However, any acidic foods spilled (such as fruit juices, tomato or vinegar) should not be permitted to remain on the finish.

If acids spill on the cooktop while it is hot, use a dry paper towel or cloth to wipe it up right away. When the surface has cooled, wash with an all-purpose cleaner and water. Rinse well.

For other spills such as fat splatterings, wash with soap and water or an all-purpose cleaner after the surface has cooled. Rinse well. Polish with a dry cloth.

Stainless Steel Surfaces (on some models)

Do not use a steel wool pad; it will scratch the surface.

To clean the stainless steel surface, use warm sudsy water or a stainless steel cleaner or polish. Always wipe the surface in the direction of the grain. Follow the cleaner instructions for cleaning the stainless steel surface.

To inquire about purchasing stainless steel appliance cleaner or polish, or to find the location of a dealer or Camco Parts Store nearest you, please call our toll-free number:

**National Parts Center 1.800.626.2002 (U.S.)
1.800.661.1616 (Canada)**

ge.com (U.S.)

www.GEAppliances.ca (Canada)

Safety Instructions

Operating Instructions

Care and Cleaning

Troubleshooting Tips

Consumer Support

Care and cleaning of the cooktop.

CAUTION: DO NOT OPERATE A BURNER WITHOUT ALL BURNER PARTS IN PLACE.

Burners and Cooktop Electrodes

Turn all controls off before removing burner parts.

NOTE: Before removing the burner caps and heads, remember their size and location. Replace them in the same location after cleaning.

The burner assemblies should always be kept clean. Spillovers should be cleaned immediately; they can clog the openings in the burner assemblies.

Remove the burner grates, burner caps and burner heads for easy cleaning.

NOTES:

- Do not attempt to remove the electrode from the cooktop or any screws from the burner head or burner base.
- Do not use steel wool or scouring powders to clean the burners.

Burner Caps and Heads

Wash burner caps and burner heads in hot, soapy water and rinse with clean running water. You may scour with a plastic scouring pad to remove burned-on food particles.

Use a sewing needle or twist tie to unclog the small holes in the burner head, if required.

To remove burned-on food, soak the burner heads in a solution of mild liquid dishwashing detergent and hot water for up to 20–30 minutes, if required. For more stubborn stains, use a toothbrush.

If the spill went inside the burner head assembly (right front burner on models JGP945 and JGP975), wash it under running water. Shake to remove any excess water. Air dry and make sure the small ignitor holes are open.

NOTE: Do not wash any burner parts in a dishwasher.

Burner Bases

The burner bases should not be removed for cleaning.

To clean the burner bases, use soapy water and a plastic scouring pad. Make sure that no water gets into the burner bases and the brass gas orifices.

Wipe clean with a damp cloth. Allow them to dry fully before using.

Cooktop Electrode

Clean this metal part



Do not clean this white ceramic part with an emery board

NOTE: Do not attempt to remove the electrode from the cooktop.

Electrodes

The electrode of the spark igniter is exposed beyond the surface of the burner base. When cleaning the cooktop, be careful not to snag the electrode of the spark igniter with your cleaning cloth. Damage to the igniter could occur.

Be careful not to push in any cooktop controls while cleaning the cooktop. A slight electrical shock might result which could cause you to knock over hot cookware.

Make sure that the white ceramic electrodes in the cooktop are clear of soil and dry. Clean the metal part of the electrode with a soft cloth. For stubborn, hardened soil, clean the metal portion of the electrode with an emery board. Do not clean the white ceramic portion of the electrode with the emery board. It is acceptable to clean the white portion of the electrode with a soft cloth, but not with an emery board.

Before reassembling the surface burners, push down on each of the white ceramic electrodes to make sure they are pressed against the burner bases.

Burner Head and Cap Replacement

Replace the burner head onto the burner base, making sure that the head is properly oriented over the burner base and the electrode. Make sure to place the correct burner head on the correct burner base and that the burner head sits level on the burner base. The burner heads are not interchangeable.

Replace the burner cap onto the burner head, making sure to place the correct burner cap on the correct burner head. The burner caps are not interchangeable. Also, make sure that the burner caps are properly seated on the burner heads.

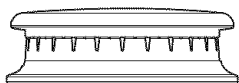

Burner cap properly seated

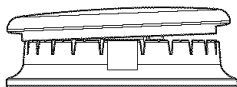

Burner cap not properly seated

JGP940 and JGP970 (all burners)
JGP933 and JGP963
(right front burner only)

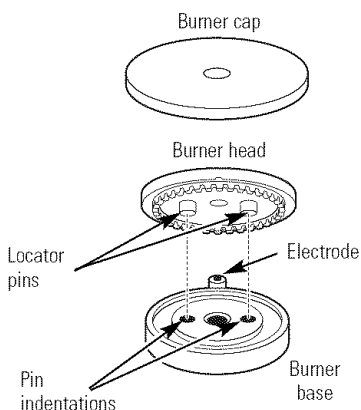

Make sure the pins in the burner heads match the burner base indentations and that they are properly seated in them by rotating the heads until they are level.

JGP328, JGP330, JGP628, JGP630,
JGP933, JGP945, JGP963, JGP975

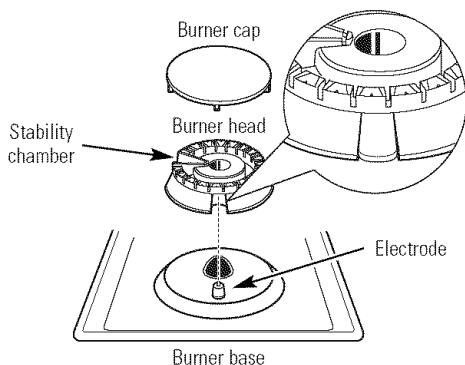

Make sure the slot in the burner head is positioned over the electrode. The burner cap has three to four pins. When replacing the cap, make sure none of the pins sits in the stability chamber.

JGP945 and JGP975
(right front burner only)

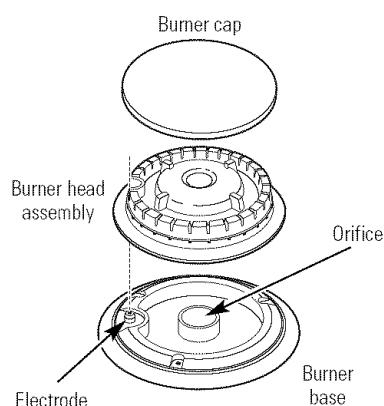

Make sure the hole in the burner head assembly is positioned over the electrode and that the burner head is fully inserted inside the burner base. A small gap between the base and head is normal.

Burner Grates

Your cooktop has professional style grates. These grates are designed for specific positions. These grates should only be used in their proper positions; they should not be interchanged. For your convenience, the undersides of the left and right grates are marked "OUTSIDE" and "INSIDE". Make sure that the sides marked "OUTSIDE" are facing the outer edge of the cooktop and the sides marked "INSIDE" are facing each other. All grates should touch once they are fully assembled on the cooktop surface.

Lift the burner grates out only when cool. Grates should be washed regularly and, of course, after spillovers. Wash them in the dishwasher or in hot, soapy water and rinse with clean water. When replacing the grates, be sure they are positioned securely over the burners.

Although they are durable, the grates will gradually lose their shine, regardless of the best care you can give them. This is due to their continual exposure to high temperatures. You will notice this sooner with lighter color grates.

Do not operate a burner for an extended period of time without cookware on the grate. The finish on the grate may chip without cookware to absorb the heat.

NOTE: Do not clean the grates in a self-cleaning oven.

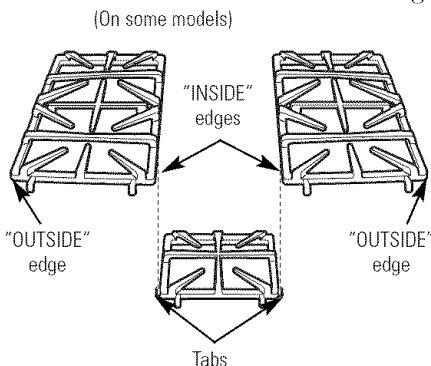
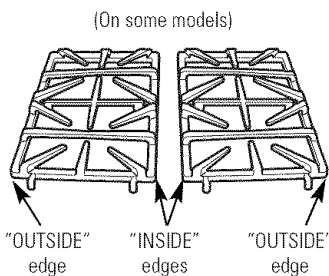

For cooktops with three grates, make sure that the tabs on either side of the center grate fit into the slots located on the "INSIDE" edge of the side grates.

Cleaning the glass cooktop surface. (on some models)

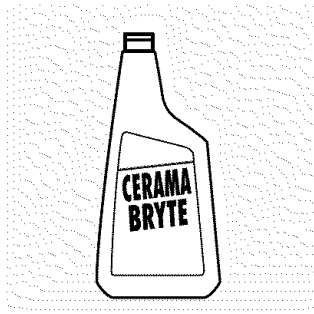

Clean your cooktop after each spill. Use CERAMA BRYTE® Ceramic Cooktop Cleaner.

Normal Daily Use Cleaning

ONLY use CERAMA BRYTE® Ceramic Cooktop Cleaner on the glass cooktop. Other creams may not be as effective.

To maintain and protect the surface of your glass cooktop, follow these steps:

- 1 Before using the cooktop for the first time, remove the burner grates and clean the cooktop with CERAMA BRYTE® Ceramic Cooktop Cleaner. This helps protect the top and makes cleanup easier.
- 2 Daily use of CERAMA BRYTE® Ceramic Cooktop Cleaner will help keep the cooktop looking new.

- 3 Shake the cleaning cream well. Apply a few drops of CERAMA BRYTE® Ceramic Cooktop Cleaner directly to the cooktop.

- 4 Use a paper towel or CERAMA BRYTE® Cleaning Pad for Ceramic Cooktops to clean the entire cooktop surface.

- 5 Use a dry cloth or paper towel to remove all cleaning residue. No need to rinse.

NOTE: It is very important that you **DO NOT** heat the cooktop until it has been cleaned thoroughly.

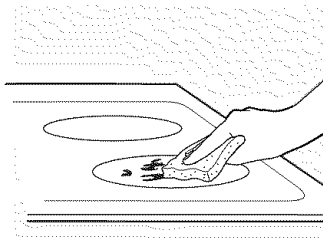

Use a CERAMA BRYTE® Cleaning Pad for Ceramic Cooktops.

Burned-On Residue

WARNING: DAMAGE to your glass surface may occur if you use scrub pads other than those recommended.

- 1 Allow the cooktop to cool.
- 2 Remove the burner grates and spread a few drops of CERAMA BRYTE® Ceramic Cooktop Cleaner on the entire burned residue area.
- 3 Using the included CERAMA BRYTE® Cleaning Pad for Ceramic Cooktops, rub the residue area, applying pressure as needed.

- 4 If any residue remains, repeat the steps listed above as needed.

- 5 For additional protection, after all residue has been removed, polish the entire surface with CERAMA BRYTE® Ceramic Cooktop Cleaner and a paper towel.

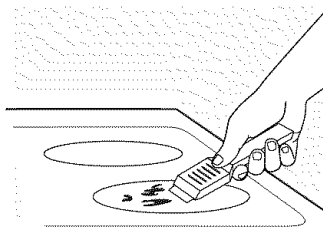

The CERAMA BRYTE® Ceramic Cooktop Scraper and all recommended supplies are available through our Parts Center. See instructions under "To Order Parts" section on next page.

NOTE: Do not use a dull or nicked blade.

Heavy, Burned-On Residue

- 1 Allow the cooktop to cool.
- 2 Remove the burner grates. Use a single-edge razor blade scraper at approximately a 45° angle against the glass surface and scrape the soil. It will be necessary to apply pressure to the razor scraper in order to remove the residue.
- 3 After scraping with the razor scraper, spread a few drops of CERAMA BRYTE® Ceramic Cooktop Cleaner on the entire burned residue area. Use the CERAMA BRYTE® Cleaning Pad to remove any remaining residue.

- 4 For additional protection, after all residue has been removed, polish the entire surface with CERAMA BRYTE® Ceramic Cooktop Cleaner and a paper towel.

Metal Marks and Scratches

- 1 Be careful not to slide pots and pans across your cooktop. It will leave metal markings on the cooktop surface.
These marks are removable using the CERAMA BRYTE® Ceramic Cooktop Cleaner with the CERAMA BRYTE® Cleaning Pad for Ceramic Cooktops.
- 2 If pots with a thin overlay of aluminum or copper are allowed to boil dry, the overlay may leave black discoloration on the cooktop.
This should be removed immediately before heating again or the discoloration may be permanent.

WARNING: Carefully check the bottom of pans for roughness that would scratch the cooktop.

Glass surface—potential for permanent damage.

Our testing shows that if you are cooking high sugar mixtures such as jelly or fudge and have a spillover, it can cause permanent damage to the glass surface unless the spillover is immediately removed.

Damage from Sugary Spills and Melted Plastic

- 1 Turn off all surface burners and, with an oven mitt, remove hot pans and grates.
- 2 Wearing an oven mitt:
 - a. Use a single-edge razor blade scraper (CERAMA BRYTE® Ceramic Cooktop Scraper) to move the spill to a cool area on the cooktop.
 - b. Remove the spill with paper towels.
- 3 Any remaining spillover should be left until the surface of the cooktop has cooled.
- 4 Don't use the surface units again until all of the residue has been completely removed.

NOTE: If pitting or indentation in the glass surface has already occurred, the cooktop glass will have to be replaced. In this case, service will be necessary.

To Order Parts

To order CERAMA BRYTE® Ceramic Cooktop Cleaner and the cooktop scraper, please call our toll-free number:



National Parts Center 800.626.2002
CERAMA BRYTE® Ceramic Cooktop Cleaner # WX10X300
CERAMA BRYTE® Ceramic Cooktop Scraper # WX10X0302
Kit # WB64X5027
(Kit includes cream and cooktop scraper)
CERAMA BRYTE® Cleaning Pads for Ceramic Cooktops # WX10X350

Before you call for service...

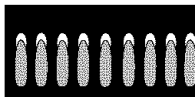

Troubleshooting Tips

Save time and money! Review the charts on these pages first and you may not need to call for service.

Problem	Possible Causes	What To Do
Burners have yellow or yellow-tipped flames	The combustion quality of burner flames needs to be determined visually.	<ul style="list-style-type: none"> Use the illustrations below to determine if your burner flames are normal. If burner flames look like A, call for service. Normal burner flames should look like B or C, depending on the type of gas you use. With LP gas, some yellow tipping on outer cones is normal. <div style="display: flex; justify-content: space-around; align-items: center;"> <div style="text-align: center;">  <p>A–Yellow flames Call for service</p> </div> <div style="text-align: center;">  <p>B–Yellow tips on outer cones Normal for LP gas</p> </div> <div style="text-align: center;">  <p>C–Soft blue flames Normal for natural gas</p> </div> </div>
Control knobs will not turn	Knob isn't pushed down.	<ul style="list-style-type: none"> To turn from the OFF position, push the knob down and then turn.
Burners do not light	Plug on cooktop is not completely inserted in the electrical outlet. Gas supply not connected or turned on. A fuse in your home may be blown or the circuit breaker tripped. Burner parts not replaced correctly. The electrodes under the burners are soiled. The white ceramic electrodes are not securely seated under the burners. Cooktop is locked. The igniter hole (on some models) is plugged.	<ul style="list-style-type: none"> Make sure electrical plug is plugged into a live, properly grounded outlet. See the Installation Instructions that came with your cooktop. Replace the fuse or reset the circuit breaker. See the <i>Care and cleaning of the cooktop</i> section. See the <i>Care and cleaning of the cooktop</i> section. See the <i>Care and cleaning of the cooktop</i> section. Unlock the cooktop. See the <i>Using the cooktop burners</i> section. See the <i>Care and cleaning of the cooktop</i> section.
Ticking sound of spark igniter persists after burner lights	Control knob is still in the LITE position.	<ul style="list-style-type: none"> Turn the knob out of the LITE position to the desired setting. Turn the burner off and relight. If ticking is still present, call for service.
Burner flames very large or yellow	Improper air to gas ratio.	<ul style="list-style-type: none"> If cooktop is connected to LP gas, check all steps in the Installation Instructions that came with your cooktop.

Problem	Possible Causes	What To Do
Cooktop makes sound when a control knob is turned on	The cooktop is locked (on some models).	<ul style="list-style-type: none"> • Turn the control lock knob to UNLOCK.
Scratches on cooktop glass surface	<p>Cookware has been slid across the cooktop surface, leaving deposits.</p> <p>Incorrect cleaning methods being used.</p> <p>Cookware with rough bottoms being used or coarse particles (salt or sand) were between the cookware and the surface of the cooktop.</p>	<ul style="list-style-type: none"> • See the <i>Cleaning the glass cooktop surface</i> section. • Scratches are not removable. Tiny scratches will become less visible in time as a result of cleaning. • To avoid scratches, use the recommended cleaning procedures. Make sure bottoms of cookware are clean before use, and use cookware with smooth bottoms.
Areas of discoloration on the glass cooktop surface	<p>Hot surface on a model with a light-colored cooktop.</p> <p>Food spillovers not cleaned before next use.</p>	<ul style="list-style-type: none"> • This is normal. The surface may appear discolored when it is hot. This is temporary and will disappear as the glass cools. • See the <i>Cleaning the glass cooktop surface</i> section.
Plastic melted to the glass cooktop surface	Hot cooktop came into contact with plastic placed on the hot cooktop.	<ul style="list-style-type: none"> • See the <i>Glass surface—potential for permanent damage</i> section in the <i>Cleaning the glass cooktop surface</i> section.
Pitting (or indentation) of the cooktop	Hot sugar mixture spilled on the cooktop.	<ul style="list-style-type: none"> • Call a qualified technician for replacement.

FOR CONSUMERS IN THE UNITED STATES
GE Service Protection Plus™

GE, a name recognized worldwide for quality and dependability, offers you Service Protection Plus™—comprehensive protection on all your appliances—**No Matter What Brand!**

***We'll Cover Any Appliance.
Anywhere. Anytime.****

Benefits Include:

- Backed by GE
- All brands covered
- Unlimited service calls
- All parts and labor costs included
- No out-of-pocket expenses
- No hidden deductibles
- One 800 number to call

You will be completely satisfied with our service protection or you may request your money back on the remaining value of your contract. No questions asked. It's that simple.

Protect your refrigerator, dishwasher, washer and dryer, range, TV, VCR and much more—**any brand!** Plus there's no extra charge for emergency service and low monthly financing is available. Even icemaker coverage and food spoilage protection is offered. You can rest easy, knowing that all your valuable household products are protected against expensive repairs.

Place your confidence in GE and call us in the U.S. toll-free at **800.626.2224** for more information.

*All brands covered, up to 20 years old, in the continental U.S.



Please place in envelope and mail to:

General Electric Company
Warranty Registration Department
P.O. Box 32150
Louisville, KY 40232-2150

FOR CONSUMERS IN THE UNITED STATES

Consumer Product Ownership Registration

Dear Customer:

Thank you for purchasing our product and thank you for placing your confidence in us.

We are proud to have you as a customer!

Follow these three steps to protect your new appliance investment:

1 Complete and mail your Consumer Product Ownership Registration today. Have the peace of mind of knowing we can contact you in the unlikely event of a safety modification.

2 After mailing the registration below, store this document in a safe place. It contains information you will need should you require service. Our service number is 800.GE.CARES (800.432.2737).

3 Read your Owner's Manual carefully. It will help you operate your new appliance properly.

Model Number

Serial Number

--	--	--	--	--	--	--	--	--	--	--	--	--	--	--	--	--	--	--	--

--	--	--	--	--	--	--	--	--	--	--	--	--	--	--	--	--	--	--	--

Important: If you did not get a registration card with your product, detach and return the form below to ensure that your product is registered, or register online at ge.com.

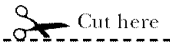

Consumer Product Ownership Registration



Model Number

Serial Number

--	--	--	--	--	--	--	--	--	--	--	--	--	--	--	--	--	--	--	--

--	--	--	--	--	--	--	--	--	--	--	--	--	--	--	--	--	--	--	--

Mr. Ms. Mrs. Miss

First Name | | | | | | | | | | | | | | | | | | | | | |

Last Name | | | | | | | | | | | | | | | | | | | | | |

Street Address | | | | | | | | | | | | | | | | | | | | | |

Apt. # | | | | | | | | | | | | | | | | | | | | | |

E-mail Address* _____

City | | | | | | | | | | | | | | | | | | | | | |

State | | | | | | | | | | | | | | | | | | | | | |

Zip Code | | | | | | | | | | | | | | | | | | | | | |

Date Placed In Use
Month | | | | | | | | | | | | | | | | | | | | | |

Day | | | | | | | | | | | | | | | | | | | | | |

Year | | | | | | | | | | | | | | | | | | | | | |

Phone Number | | | | | | | | | | | | | | | | | | | | | |

* Please provide your e-mail address to receive, via e-mail, discounts, special offers and other important communications from GE Appliances (GEA).

Check here if you do not want to receive communications from GEA's carefully selected partners.

FAILURE TO COMPLETE AND RETURN THIS CARD DOES NOT DIMINISH YOUR WARRANTY RIGHTS.

For more information about GEA's privacy and data usage policy, go to ge.com and click on "Privacy Policy" or call 800.626.2224.



GE Consumer & Industrial Appliances
General Electric Company
Louisville, KY 40225
ge.com

Please place in envelope and mail to:
Veuillez mettre dans une enveloppe et envoyez à :

**OWNERSHIP REGISTRATION
P.O. BOX 1780
MISSISSAUGA, ONTARIO
L4Y 4G1**

(FOR CANADIAN CONSUMERS ONLY)



For Canadian
Customers



Pour les
Consommateurs
Canadiens

CUT ALONG THIS LINE AND RETURN CARD--THANKS

OWNERSHIP REGISTRATION CERTIFICATE - FICHE D'INSCRIPTION DU PROPRIÉTAIRE

Please register your product to enable us to contact you in the remote event a safety notice is issued for this product and to allow for efficient communication under the terms of your warranty, should the need arise.

Veillez enregistrer votre produit afin de nous permettre de communiquer avec vous si jamais un avis de sécurité concernant ce produit était émis et de communiquer facilement avec vous en vertu de votre garantie, si le besoin s'en fait sentir.

REGISTER ON-LINE: www.geappliances.ca		MAIL TO: P.O. BOX 1780, MISSISSAUGA
ENREGISTREMENT SUR INTERNET À: www.electromenagersge.ca		POSTER À: ONTARIO, L4Y 4G1
<input type="checkbox"/> MR./M	<input type="checkbox"/> MRS./MME.	FIRST NAME / PRÉNOM
<input type="checkbox"/> MISS/MLLE.	<input type="checkbox"/> MS.	LAST NAME / NOM
STREET NO./N° RUE		APT. NO./APP./RR#
STREET NAME/RUE		
CITY/VILLE		PROVINCE
		POSTAL CODE/POSTAL
AREA CODE/IND. RÉG.	TELEPHONE	E-MAIL
DID YOU PURCHASE A SERVICE CONTRACT FOR THIS APPLIANCE? AVEZ-VOUS ACHETÉ UN CONTRAT DE SERVICE POUR CET APPAREIL ?		YES/OUÍ <input type="checkbox"/> NO/NON <input type="checkbox"/>
		IF YES/SI OUI: EXPIRATION Y/A M D/J
NAME OF SELLING DEALER/NOM DU MARCHAND		MODEL/MODÈLE
INSTALLATION DATE/DATE D'INSTALLATION Y/A M D/J	CORRESPONDENCE CORRESPONDANCE	SERIAL/SÉRIE
	<input type="checkbox"/> ENGLISH <input type="checkbox"/> FRANÇAIS	
<input type="checkbox"/> I do not wish to receive any promotional offers regarding this product. <input type="checkbox"/> Je ne désire pas recevoir d'offres promotionnelles concernant ce produit.		

Notes.

Safety Instructions

Operating Instructions

Care and Cleaning

Troubleshooting Tips

Consumer Support

GE Gas Cooktop Warranty. *(For Customers in the United States)*

All warranty service provided by our Factory Service Centers, or an authorized Customer Care® technician. To schedule service, on-line, 24 hours a day, visit us at ge.com, or call 800.GE.CARES (800.432.2737). Please have serial number and model number available when calling for service.

Staple your receipt here. Proof of the original purchase date is needed to obtain service under the warranty.

For The Period Of: **GE Will Replace:**

One Year

From the date of the original purchase

Any part of the cooktop which fails due to a defect in materials or workmanship. During this **limited one-year warranty**, GE will also provide, **free of charge**, all labor and related service costs to replace the defective part.

What GE Will Not Cover:

- Service trips to your home to teach you how to use the product.
- Replacement of house fuses or resetting of circuit breakers.
- Improper installation, delivery or maintenance.
- Damage to the product caused by accident, fire, floods or acts of God.
- Failure of the product if it is abused, misused, or used for other than the intended purpose or used commercially.
- Incidental or consequential damage caused by possible defects with this appliance.
- Damage caused after delivery.
- Product not accessible to provide required service.

EXCLUSION OF IMPLIED WARRANTIES—Your sole and exclusive remedy is product repair as provided in this Limited Warranty. Any implied warranties, including the implied warranties of merchantability or fitness for a particular purpose, are limited to one year or the shortest period allowed by law.

This warranty is extended to the original purchaser and any succeeding owner for products purchased for home use within the USA. If the product is located in an area where service by a GE Authorized Servicer is not available, you may be responsible for a trip charge or you may be required to bring the product to an Authorized GE Service location for service. In Alaska, the warranty excludes the cost of shipping or service calls to your home.

Some states do not allow the exclusion or limitation of incidental or consequential damages. This warranty gives you specific legal rights, and you may also have other rights which vary from state to state. To know what your legal rights are, consult your local or state consumer affairs office or your state's Attorney General.

Warrantor: General Electric Company, Louisville, KY 40225

Gas Cooktop Warranty. (For Customers in Canada)

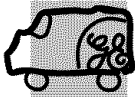

All warranty service provided by our Factory Service Centers or an authorized Customer Care® technician. For service, call 1.800.361.3400. Please have serial number and model number available when calling for service.

Staple your receipt here.
Proof of the original purchase date is needed to obtain service under the warranty.

For The Period Of: We Will Replace:

One Year

From the date of the original purchase

Any part of the cooktop which fails due to a defect in materials or workmanship. During this **limited one-year warranty**, GE will also provide, **free of charge**, all labor and related service costs to replace the defective part.

What We Will Not Cover:

- Service trips to your home to teach you how to use the product.
- Improper installation, delivery or maintenance.
- Failure of the product if it is abused, misused, or used for other than the intended purpose or used commercially.
- Replacement of house fuses or resetting of circuit breakers.
- Damage to the product caused by accident, fire, floods or acts of God.
- Incidental or consequential damage caused by possible defects with this appliance.
- Damage caused after delivery.
- Product not accessible to provide required service.

EXCLUSION OF IMPLIED WARRANTIES—Your sole and exclusive remedy is product repair as provided in this Limited Warranty. Any implied warranties, including the implied warranties of merchantability or fitness for a particular purpose, are limited to one year or the shortest period allowed by law.

Warrantor: CAMCO INC.

Safety Instructions

Operating Instructions

Care and Cleaning

Troubleshooting Tips

Consumer Support

Consumer Support



GE Appliances Website

In the U.S.: **ge.com**

Have a question or need assistance with your appliance? Try the GE Appliances Website 24 hours a day, any day of the year! For greater convenience and faster service, you can now download Owner's Manuals, order parts, catalogs, or even schedule service on-line. You can also "Ask Our Team of Experts™" your questions, and so much more... **In Canada: www.geappliances.ca**

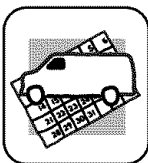

Schedule Service

In the U.S.: **ge.com**

Expert GE repair service is only one step away from your door. Get on-line and schedule your service at your convenience 24 hours any day of the year! Or call 800.GE.CARES (800.432.2737) during normal business hours. **In Canada, call 1.800.361.3400**

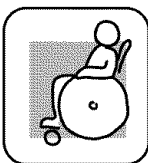

Real Life Design Studio

In the U.S.: **ge.com**

GE supports the Universal Design concept—products, services and environments that can be used by people of all ages, sizes and capabilities. We recognize the need to design for a wide range of physical and mental abilities and impairments. For details of GE's Universal Design applications, including kitchen design ideas for people with disabilities, check out our Website today. For the hearing impaired, please call 800.TDD.GEAC (800.833.4322).

In Canada, contact: Manager, Consumer Relations, Camco, Inc.
Suite 310, 1 Factory Lane
Moncton, N.B. E1C 9M3



Extended Warranties

In the U.S.: **ge.com**

Purchase a GE extended warranty and learn about special discounts that are available while your warranty is still in effect. You can purchase it on-line anytime, or call 800.626.2224 during normal business hours. GE Consumer Home Services will still be there after your warranty expires. **In Canada, call 1.888.261.2133**

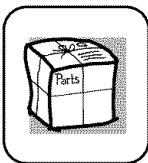

Parts and Accessories

In the U.S.: **ge.com**

Individuals qualified to service their own appliances can have parts or accessories sent directly to their homes (VISA, MasterCard and Discover cards are accepted). Order on-line today, 24 hours every day or by phone at 800.626.2002 during normal business hours.

Instructions contained in this manual cover procedures to be performed by any user. Other servicing generally should be referred to qualified service personnel. Caution must be exercised, since improper servicing may cause unsafe operation.

Customers **in Canada** should consult the yellow pages for the nearest Camco service center, or call 1.888.261.3055.



Contact Us

In the U.S.: **ge.com**

If you are not satisfied with the service you receive from GE, contact us on our Website with all the details including your phone number, or write to:

General Manager, Customer Relations
GE Appliances, Appliance Park
Louisville, KY 40225

In Canada: www.geappliances.ca, or write to: Director, Consumer Relations, Camco, Inc.
Suite 310, 1 Factory Lane
Moncton, N.B. E1C 9M3



Register Your Appliance

In the U.S.: **ge.com**

Register your new appliance on-line—at your convenience! Timely product registration will allow for enhanced communication and prompt service under the terms of your warranty, should the need arise. You may also mail in the preprinted registration card included in the packing material. **In Canada: www.geappliances.ca**