

Use & Care Guide
Guía de uso y cuidada
English / Español

Model/Modelos: 790.7830*, 7840*, 7841*

Kenmore Elite®

Gas Range

Estufa a gas

* = color number, código de color

P/N 316901017

Sears Brands Management Corporation
Hoffman Estates, IL 60179 U.S.A.

www.kenmore.com
www.sears.com



Table of Contents

Warranty	2	Conv Bake	17
Important Safety Instructions	3-6	Conv Roast	18
Product Record/Serial Plate Location	6	Conv Convert	18
Range Features	7	Broil	19
Before Setting Oven Controls	8	Cakes Breads	20
Removing, replacing and arranging oven racks	8	Meat probe	20-21
Before Setting Surface Controls	9	Slow Cook	22
Setting Surface Controls	10-11	Warm & Hold™	23
Setting surface burners	10	Recipe Recall	23
Setting Double Ring burner (some models)	11	Accent light	24
Oven Control Functions	12	Adjusting oven temperature	25
Setting Oven Controls	13-25	Restoring factory default settings	25
Setting clock	13	Sabbath feature	26-27
Setting timer	13	Warmer Drawer	28-31
Add 1 minute	13	Warmer drawer controls	29
Setting 12 or 24 hour display mode	13	Proof Bread	30
Changing between continuous bake setting or 12-Hour		Flex Clean	31-32
Energy Saving feature	13	Care & Cleaning	33-36
Changing oven temperature display mode	14	Cleaning recommendation table	33
Setting silent or audible control mode	14	Cleaning the cooktop and surface burners	34
Oven Lockout	14	Replacing oven lights	35
Setting Preheat	15	Removing and replacing lift-off oven door	36
Setting Bake	15	Before You Call - Solutions to common problems	37-39
Setting Cook Time	16	Master Protection Agreements	41
Setting Delay Start	16	Sears Service	back cover

Kenmore Elite Limited Warranty

When installed, operated and maintained according to all instructions supplied with the product, if this appliance fails due to a defect in material and workmanship within one year from the date of purchase, call 1-800-4-MY-HOME® to arrange for free repair.

For five years from the date of purchase, if the cooktop glass fails due to thermal shock or the cooktop elements are defective, call 1-800-4-MY-HOME® to arrange for free repair. After the first year from purchase date, you must pay the labor cost of part installation. This warranty applies for only 90 days from the date of purchase if this appliance is ever used for other than private family purposes.

This warranty covers only defects in material and workmanship. Sears will NOT pay for:

1. Cracks in a ceramic glass cooktop that are not a result of thermal shock.
2. Stains and scratches on a ceramic glass cooktop resulting from failure to maintain it properly according to all instructions supplied with the product.
3. Expendable items that can wear out from normal use, including but not limited to filters, belts, light bulbs, and bags.
4. A service technician to instruct the user in correct product installation, operation or maintenance.
5. A service technician to clean or maintain this product.
6. Damage to or failure of this product if it is not installed, operated or maintained according to all instructions supplied with the product.
7. Damage to or failure of this product resulting from accident, abuse, misuse or use for other than its intended purpose.
8. Damage to or failure of this product caused by the use of detergents, cleaners, chemicals or utensils other than those recommended in all instructions supplied with the product.
9. Damage to or failure of parts or systems resulting from unauthorized modifications made to this product.

Disclaimer of implied warranties; limitation of remedies

Customer's sole and exclusive remedy under this limited warranty shall be product repair as provided herein. Implied warranties, including warranties of merchantability or fitness for a particular purpose, are limited to one year or the shortest period allowed by law. Sears shall not be liable for incidental or consequential damages. Some states and provinces do not allow the exclusion or limitation of incidental or consequential damages, or limitation on the duration of implied warranties of merchantability or fitness, so these exclusions or limitations may not apply to you.

This warranty applies only while this appliance is used in the United States or Canada.

This warranty gives you specific legal rights, and you may also have other rights which vary from state to state.

Sears Brands Management Corporation, Hoffman Estates, IL 60179 U.S.A.

Sears Canada Inc., Toronto, Ontario, Canada M5B 2B8

All rights reserved. Printed in the USA.

Important Safety Instructions

Read all instructions before using this appliance.

This manual contains important safety symbols and instructions. Please pay attention to these symbols and follow all instructions given.

Definitions

⚠ This is the safety alert symbol. It is used to alert you to potential personal injury hazards. Obey all safety messages that follow this symbol to avoid possible injury or death.

Do not attempt to install or operate your appliance until you have read the safety precautions in this manual. Safety items throughout this manual are labeled with a WARNING or CAUTION statement based on the risk type.

⚠ WARNING - indicates a potentially hazardous situation which, if not avoided, may result in death or serious injury.

⚠ CAUTION - indicates a potentially hazardous situation which, if not avoided, may result in minor or moderate injury.

- **Remove all tape and packaging before using the range.**
Destroy the carton and plastic bags after unpacking the range. Never allow children to play with packaging material.
- **Proper Installation—Be sure your appliance is properly installed and grounded by a qualified technician in accordance with the National Fuel Gas Code ANSI Z223.- latest edition, or in Canada CAN/CGA B149.1, and CAN/CGA B149.2, and the National Electrical Code ANSI/NFPA No.70-latest edition, or in Canada CSA Standard C22.1, Canadian Electrical Code, Part 1, and local code requirements.** Install only per installation instructions provided in the literature package for this range. Ask your dealer to recommend a qualified technician and an authorized repair service. Know how to disconnect the power to the range at the circuit breaker or fuse box in case of an emergency.
- **User servicing—Do not repair or replace any part of the appliance unless specifically recommended in the manuals.** All other servicing should be done only by a qualified technician. This may reduce the risk of personal injury and damage to the range.

Ask your dealer to recommend a qualified technician and an authorized repair service. Know how to disconnect the power to the range at the circuit breaker or fuse box in case of an emergency.

⚠ WARNING If the information in this manual is not followed exactly, a fire or explosion may result causing property damage, personal injury or death.

FOR YOUR SAFETY:

- Do not store or use gasoline or other flammable vapors and liquids in the vicinity of this or any other appliance.
- **WHAT TO DO IF YOU SMELL GAS:**
 - Do not try to light any appliance.
 - Do not touch any electrical switch; do not use any phone in your building.
 - Immediately call your gas supplier from a neighbor's phone. Follow the gas supplier's instructions.
 - If you cannot reach your gas supplier, call the fire department.
- Installation and service must be performed by a qualified installer, servicer or the gas supplier.

⚠ WARNING

- All ranges can tip.
- Injury to persons could result.
- Install anti-tip device packed with range.
- See Installation Instructions.



To reduce the risk of tipping, the range must be secured by properly installed anti-tip bracket provided with the range. To check if the bracket is installed properly, visually check that rear leveling leg is inserted into and fully secured by the anti-tip bracket by removing lower front panel or storage drawer from the range.



For models equipped with a warmer drawer or lower oven, grasp the top rear edge of the range and carefully attempt to tilt it forward. Refer to the installation instructions for proper anti-tip bracket installation.

- **Never modify or alter the construction of a range by removing the leveling legs, panels, wire covers, anti-tip brackets/screws, or any other part of the range.**
- Remove the oven door from any unused range if it is to be stored or discarded.

Save these instructions for future reference.

Important Safety Instructions

Air curtain or other overhead range hoods, which operate by blowing a downward air flow on to a range, shall not be used in conjunction with gas ranges other than when the hood and range have been designed, tested and listed by an independent test laboratory for use in combination with each other.

For electric ignition models only: Do not attempt to operate the range during a power failure. If the power fails, always turn off the range. If the range is not turned off and the power resumes, the range will begin to operate again. Once the power resumes, reset the clock and oven function.

⚠ WARNING NEVER use this appliance as a space heater to heat or warm the room. Doing so may result in CARBON MONOXIDE poisoning.

⚠ WARNING NEVER cover any slots, holes or passages in the oven bottom or cover an entire oven rack with materials such as aluminum foil. Doing so blocks air flow through the oven and may cause CARBON MONOXIDE poisoning. Aluminum foil linings may trap heat, causing a fire hazard.

⚠ WARNING Stepping, leaning or sitting on the door or drawers of a range can result in serious injuries and also cause damage to the appliance. DO NOT allow children to climb or play around the range. The weight of a child on an open oven door may cause the range to tip, resulting in serious burns or other injury.

⚠ WARNING Storage in or on appliance — flammable materials should not be stored in an oven, near surface units or in the storage drawer, warmer drawer or lower oven. This includes paper, plastic and cloth items, such as cookbooks, plasticware and towels, as well as flammable liquids. Do not store explosives, such as aerosol cans, on or near the range.

⚠ WARNING DO NOT LEAVE CHILDREN ALONE — children should not be left alone or unattended in the area where appliance is in use. They should never be allowed to sit or stand on any part of the appliance, including the storage drawer, lower broiler drawer, warmer drawer or lower double oven.

⚠ CAUTION Do not store items of interest to children in the cabinets above a range or on the backguard of the range. Children climbing on the range to reach items could be seriously injured.

⚠ CAUTION Do not use water or flour on grease fires — smother the fire with a pan lid, or use baking soda, a dry chemical or foam-type extinguisher.

⚠ CAUTION When heating fat or grease, watch it closely. Fat or grease may catch fire if allowed to become too hot.

⚠ CAUTION Use dry potholders — moist or damp potholders on hot surfaces may result in burns from steam. Do not let potholders touch hot heating elements. Do not use a towel or other bulky cloth instead of a potholder.

⚠ CAUTION Do not heat unopened food containers — buildup of pressure may cause container to burst and result in injury.

IMPORTANT INSTRUCTIONS FOR USING YOUR OVEN

⚠ CAUTION Protective Liners — DO NOT use aluminum foil to line the oven bottom. Only use aluminum foil as recommended in this manual. Improper installation of these liners may result in risk of electric shock, or fire.

- **Use care when opening oven door , warmer drawer or lower oven door** — Stand to the side of the range when opening the door of a hot oven. Let hot air or steam escape before you remove or replace food in the oven.
- **Keep oven vent ducts unobstructed.** The oven vent is located below the backguard. Touching the surfaces in this area when the oven is operating may cause severe burns. Also, do not place plastic or heat-sensitive items on or near the oven vent. These items could melt or ignite.
- **Placement of Oven Racks.** Always place oven racks in desired location while oven is cool. If rack must be moved while oven is hot use extreme caution. Use potholders and grasp the rack with both hands to reposition. Do not let potholders contact the hot heating elements in the oven. Remove all utensils from the rack before moving.
- **Do not use the broiler pan without its insert.** The broiler pan and its insert allow dripping fat to drain and be kept away from the high heat of the broiler.
- **Do not cover the broiler insert with aluminum foil.** Exposed fat and grease could ignite.

Save these instructions for future reference.

Important Safety Instructions

Important safety notice

The California Safe Drinking Water and Toxic Enforcement Act requires the Governor of California to publish a list of substances known to the state to cause cancer, birth defects or other reproductive harm, and requires businesses to warn customers of potential exposure to such substances.

IMPORTANT INSTRUCTIONS FOR USING YOUR COOKTOP

⚠ WARNING Use Proper Flame Size — Adjust flame size so it does not extend beyond the edge of the utensil. The use of undersized utensils will expose a portion of the burner flame to direct contact and may result in ignition of clothing. Proper relationship of utensil to flame will also improve efficiency.

- **Know which knob controls each surface burner.** Place a pan of food on the burner before turning it on, and turn the burner off before removing the pan.
- **Always turn knob to the full LITE position when igniting top burners.** Visually check that burner has lit. Then adjust the flame so it does not extend beyond the edge of the utensil.
- **Utensil handles should be turned inward and not extend over adjacent surface burners** — To reduce the risk of burns, ignition of flammable materials, and spillage due to unintentional contact with the utensil, the handle of the utensil should be positioned so that it is turned inward, and does not extend over adjacent surface burners.
- **Never leave surface burners unattended at high heat settings** — Boilovers cause smoking and greasy spillovers that may ignite, or a pan that has boiled dry may melt.
- **Glazed cooking utensils** — Only certain types of glass, glass/ceramic, ceramic, earthenware, or other glazed utensils are suitable for cook top service without breaking due to the sudden change in temperature. Check the manufacturer's recommendations for cook top use.
- **When flaming foods under a ventilating hood, turn the fan on.**

IMPORTANT INSTRUCTIONS FOR SELF-CLEANING OVENS

- **Clean in the self-cleaning cycle only the parts listed in this Use & Care Manual.** Before self-cleaning the oven, remove the oven racks, broil pan, broil pan insert and any cookware, cooking utensils or foods from the oven.
- **Do Not Use Oven Cleaners** — No commercial oven cleaner or oven liner protective coating of any kind should be used in or around any part of the oven.
- **Do Not Clean Door Gasket** — The door gasket is essential for a good seal. Care should be taken not to rub, damage or move the gasket.
- The health of some birds is extremely sensitive to the fumes given off during the self-cleaning cycle of any range. Move birds to another well-ventilated room.

IMPORTANT INSTRUCTIONS FOR CLEANING YOUR RANGE

⚠ CAUTION Before manually cleaning any part of the range, be sure all controls are turned OFF and the range is COOL. The range may be hot and can cause burns.

- **Clean the range regularly to keep all parts free of grease that could catch fire.** Pay particular attention to the area around each surface burner. Do not allow grease to accumulate.
- **Kitchen cleaners and aerosols** — Always follow the manufacturer's recommended directions for use. Be aware that excess residue from cleaners and aerosols may ignite causing damage and injury.
- **Clean ventilating hoods frequently** — Grease should not be allowed to accumulate on the hood or filter. Follow the manufacturer's instructions for cleaning hoods.

Save these instructions for future reference.

Important Safety Instructions

Grounding Instructions

⚠️ WARNING Avoid fire hazard or electrical shock. **DO NOT** use an adapter plug, an extension cord, or remove grounding prong from electrical power cord. Failure to follow this warning can cause serious injury, fire or death.

This appliance is equipped with a 3-prong grounding plug for your protection against shock hazard and should be plugged directly into a properly grounded receptacle. **DO NOT** cut or remove the grounding prong from this plug.

For personal safety, the range must be properly grounded. For maximum safety, the power cord must be plugged into an electrical outlet that is correctly polarized and properly grounded.

Grounding type wall receptacle

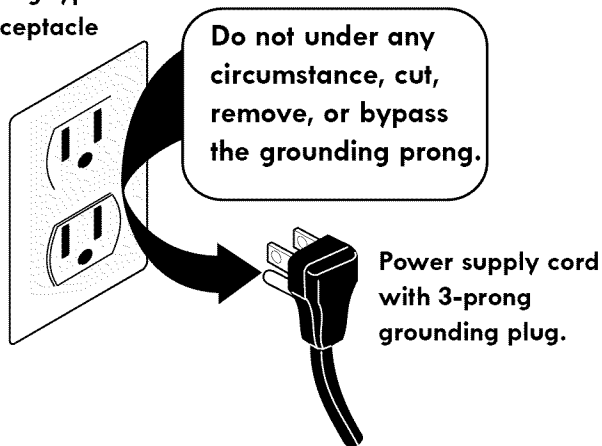

If a 2-prong wall receptacle is the only available outlet, it is the personal responsibility of the consumer to have it replaced with a properly grounded 3-prong wall receptacle installed by a qualified electrician.

See the INSTALLATION INSTRUCTIONS packaged with this range for complete installation and grounding instructions.

Conversion to L.P. Gas

⚠️ WARNING Personal injury or death from electrical shock may occur if the range is not installed by a qualified installer or electrician.

⚠️ WARNING Any additions, changes or conversions required in order for this appliance to satisfactorily meet the application needs must be made by a qualified technician.

This appliance allows for conversion to Liquefied Petroleum (L.P.) Gas.

If L.P. conversion is needed, contact your local L.P. Gas provider for assistance. The L.P. conversion kit is provided with this appliance and is located on the lower REAR (back side) panel of the range. Before installing the kit be sure to follow the L.P. Installation Instructions carefully.

Save these instructions for future reference.

Product Record

In this space below, record the date of purchase, model and serial number of your product. You will find the model and serial number printed on an identification plate. See **bottom of this page** for serial plate location.

Model No. 790.

Serial No. _____

Date of Purchase _____

Save sales receipt for future reference.

Serial Plate Location

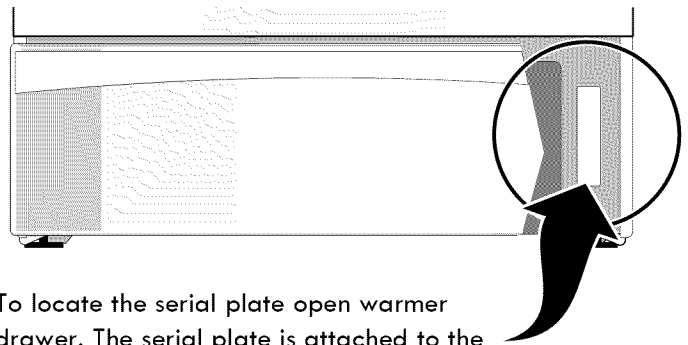

To locate the serial plate open warmer drawer. The serial plate is attached to the lower right oven frame.

Range Features

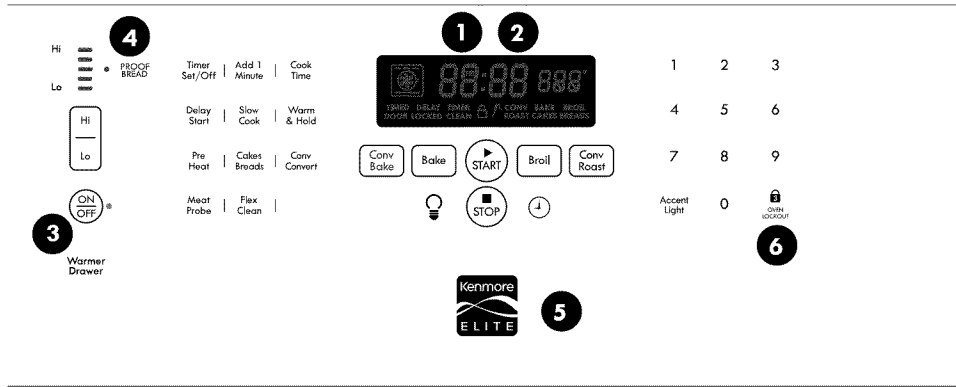

Your gas range features include:

1. Electronic oven control with timer.
2. Glass touch sensitive control panel.
3. Warm & Ready™ drawer control & indicator light.
4. Proof Bread indicator light.
5. Accent Light.
6. Oven Lockout control.
7. Left Front burner valve & knob.
8. Left Rear burner valve & knob.
9. Center Burner valve & knob.
10. Right Front burner valve & knob.
11. Right Rear burner valve & knob.
12. Easy to clean upswept cooktop.
13. Automatic door interior light switch.
14. Oven door latch mechanism.
15. Two interior oven lights with protective covers.
16. Self-Cleaning oven interior.
17. Adjustable heavy duty porcelain oven racks.
18. Oven convection fan & cover.
19. Full width oven door with large window.
20. Large 1-piece oven door handle.
21. Warm & Ready™ Drawer.
22. Large 1-piece warmer drawer handle.
23. Leveling legs and Anti-tip bracket (included).
24. 12,000 BTU burner (some models)
25. 14,200 BTU Power Burner (some models).
26. 9,500 BTU burner
27. 10,000 BTU Center Burner (some models).
28. 5,000 BTU Simmer Burner.
29. 18,000 BTU Turbo Boil burner (some models).
30. 650 to 18,000 BTU Double Ring burner (on some models).
31. Warmer drawer rack.

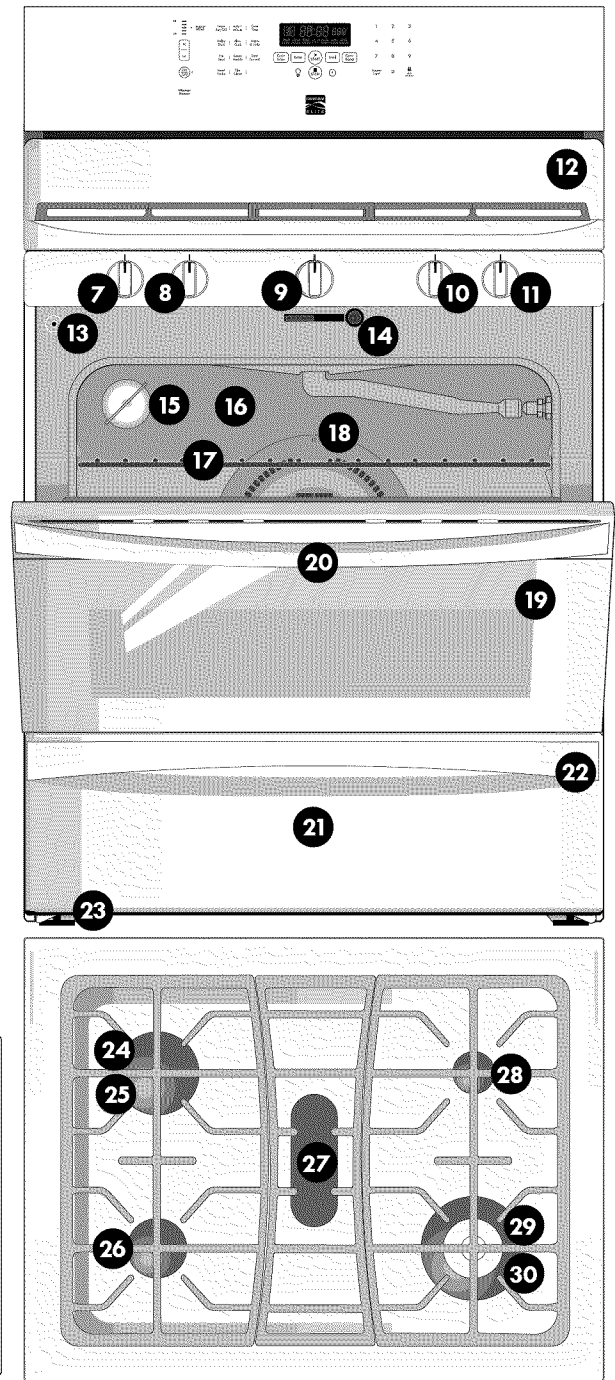

Please note: The features shown for your appliance may vary according to model type and color.

Before Setting Oven Controls

Oven vent location

The oven vent is centered just below the control panel as shown in Fig. 1. When the oven is on, warm air passes through this vent. This venting is necessary for proper air circulation in the oven and good baking results. **Do not block oven vent.**

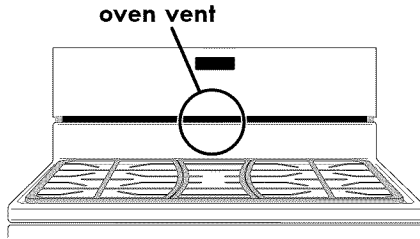

Fig. 1

Removing, replacing and arranging oven racks

⚠ CAUTION Always use pot holders or oven mitts when using the oven. When cooking, the oven interior and exterior, oven racks and cooktop will become very hot which can cause burns.

⚠ WARNING Protective Liners — **DO NOT USE ALUMINUM FOIL** to line the oven bottom. Only use aluminum foil as recommended in this manual. Improper installation of these liners may result in risk of electric shock, or fire.

Arranging - always arrange the oven racks when the oven is cool (prior to operating the oven).

To remove - pull the rack forward until it stops. Lift up front of rack and slide out.

To replace - fit oven rack onto the rack guides on both sides of oven walls. Tilt the front of oven rack upward and slide the rack back into place. Be sure oven racks are level before using.

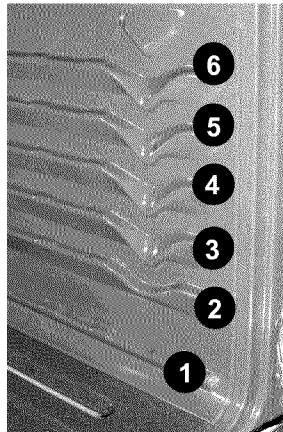

Fig. 2

Recommended oven rack positions by food type

(Refer to Fig. 2)

Food type	Position
Broiling	See broil
Cookies, cakes, pies, biscuits & muffins	3 or 4
Frozen pies, angel food cake, yeast, bread and casseroles	2 or 3
Small cuts of meat or poultry	1 or 2
Turkey, roast or ham	1 or 2

Types of oven racks

flat oven rack

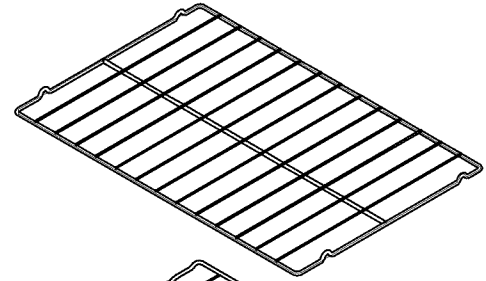

flat handle oven rack

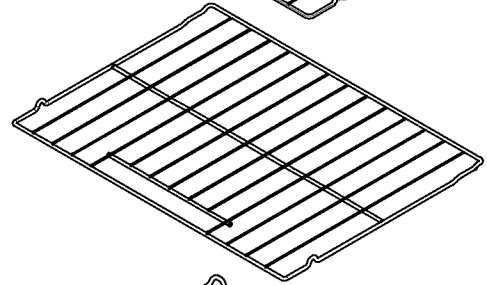

offset oven rack

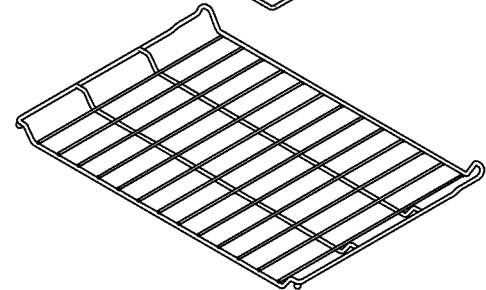

The **flat oven rack** (some models) or **flat handle oven rack** (some models) may be used for most cooking needs.

The **offset oven rack** (some models) is designed to place the base of the rack about 1/2 of a rack position lower than flat oven racks. This design provides several additional possible positions between the flat rack positions.

Air circulation in the oven

For best baking results allow 2-4" (5-10 cm) around the cookware for proper air circulation and be sure pans and cookware do not touch each other, the oven door, sides or back of the oven cavity. Hot air must be able to circulate around the cookware in the oven for even heat to reach around the food (See Fig. 3).

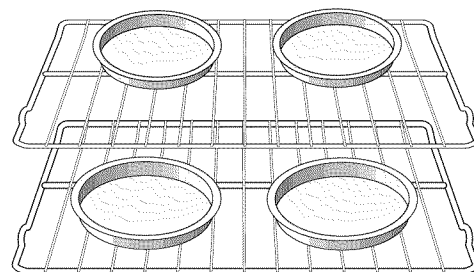

Fig. 3

Before Setting Surface Controls

Using proper cookware

⚠ CAUTION DO NOT place flammable items such as plastic salt and pepper shakers, spoon holders or plastic wrappings on the cooktop when it is in use. These items could melt or ignite. Potholders, towels or wooden spoons could catch fire if placed too close to the range cooktop.

Important: DO NOT place aluminum foil, or ANY material that can melt on the range cooktop. If these items melt they may damage the cooktop.

For best cooking results, cookware should have flat bottoms that rest level on the surface burner grate. Before using cookware, check for flatness by rotating a ruler across the bottom of the cookware (Fig. 1).

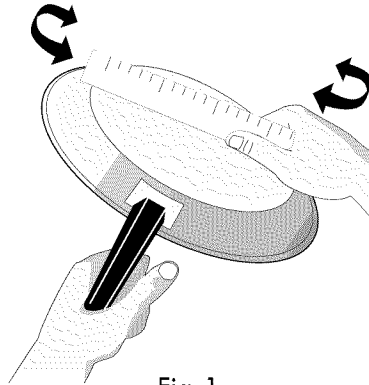

Fig. 1

Please note: The size and type of utensil used, and the amount and type of food being cooked will influence the burner flame setting needed for best cooking results.

Cookware material types

The most popular materials for cookware available are:

Aluminum - Excellent heat conductor. Some types of food will cause it to darken (Anodized aluminum cookware resists staining & pitting).

Copper - Excellent heat conductor but discolors easily.

Stainless - Slow heat conductor with uneven cooking results. Is durable, easy to clean and resists staining.

Cast Iron - A slow heat conductor however will retain heat very well. Cooks evenly once cooking temperature is reached.

Porcelain-enamel on metal - Heating characteristics will vary depending on base material.

Glass - Slow heat conductor.

Setting proper burner flame size

⚠ CAUTION Never extend the flame beyond the outer edge of the cooking utensil. A higher flame wastes energy, and increases your risk of being burned by the flame.

The color of the flame is the key to proper burner adjustment. A good flame is clear, blue and hardly visible in a well-lighted room. Each cone of flame should be steady and sharp. Adjust or clean burner if flame is yellow-orange.

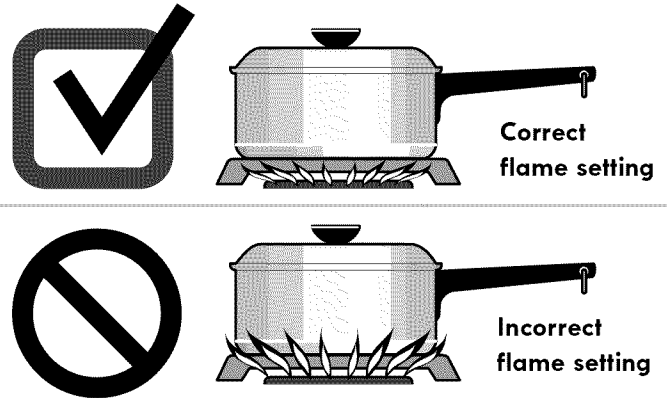

For most cooking; start on the highest setting and then turn to a lower setting to complete the process. Use the recommendations below as a guide for determining proper flame size for various types of cooking (Fig. 2)

For deep fat frying; use a thermometer and adjust the surface knob accordingly. If the fat is too cool, the food will absorb the fat and be greasy. If the fat is too hot, the food will brown so quickly that the center will be undercooked. Do not attempt to deep fat fry too much food at once as the food will neither brown or cook properly.

Flame size*	Type of cooking
High flame	Start most foods; bring water to a boil; pan broiling.
Medium flame	Maintain a slow boil; thicken sauces, gravies; steaming.
Low flame	Keep foods cooking; poach; stewing.

Fig. 2

*These settings are based for medium-weight metal or aluminum pans with lids. Settings may vary when using cookware made from different materials.

Setting Surface Controls

Setting surface burners

Your gas appliance may be equipped with different sized surface burners. The ability to heat food quicker and in larger volumes increases as the burner size increases. It is important to select cookware that is suitable for the amount and type of food being prepared.

The smaller cooktop **SIMMER** burner (right rear cooktop position) is best suited for simmering delicate sauces, etc.

The standard size cooktop burners may be used for most surface cooking needs. Some models are equipped with an oblong shaped **CENTER** burner. This burner is rated 10,000 BTU and will heat like any other standard sized burner.

The larger cooktop **POWER** burner (on some models) or **TURBO BOIL** burner (on some models) are recommended for bringing large quantities of liquid to temperature and when preparing larger quantities of food.

To set surface burners:

1. Place cooking utensil on center of surface burner grate. Be sure the cooking utensil sets stable on the burner grate.
2. Push the desired surface control knob in and turn counterclockwise out of the **OFF** position (Fig. 1).
3. Release the surface control knob and rotate to the **LITE** position. Visually check that the burner has lit.
4. Once the burner has a flame, push the control knob in and turn counterclockwise to the desired flame size. Use the control knob markings and adjust the flame as needed.

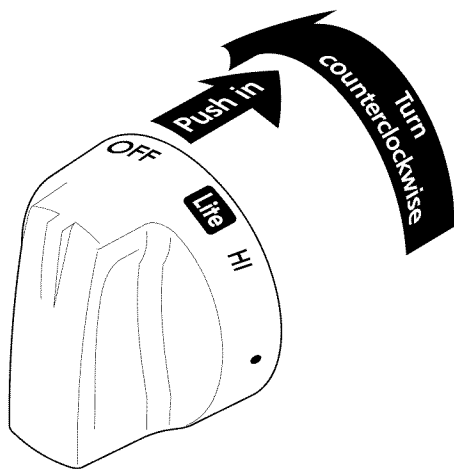

Fig. 1

⚠ CAUTION Do not place flammable items such as plastic salt and pepper shakers, spoon holders or plastic wrappings on the cooktop when it is in use. These items could melt or ignite. Potholders, towels or wooden spoons could catch fire if placed too close to the range cooktop.

⚠ CAUTION Do not place aluminum foil, or ANY material that can melt on the range cooktop. If these items melt they may permanently damage the cooktop surface.

Important notes:

- **DO NOT** cook with the surface control knob left in the LITE position. The electronic ignitor will continue to spark if the control knob setting remains in the LITE position .
- When setting any surface control knob to the LITE position, all electronic surface ignitors will spark at the same time. However, only the surface burner you are setting will ignite.
- **NEVER** place or straddle a cooking utensil over two different surface cooking areas at the same time. This can cause uneven heating results.
- In the event of an electrical power outage, the surface burners can be lit manually. Use caution when lighting surface burners manually. To light a surface burner, hold a lit match to the burner head, then slowly turn the surface control knob to LITE. After burner lights push in and turn knob to desired setting.

Setting Surface Controls

Setting Double Ring Burner (some models)

The versatile **Double Ring** surface burner offers a complete range of gas surface settings from the same burner position.

At the lowest setting, only the burner's inner ring is active, providing a smaller flame that is perfect for simmering. If needed, the burner's outer ring may be added and when set for HI will provide a gas flame that may be used to bring a large pan of liquid to boil quickly.

Operating the Double Ring Burner:

1. Push right front surface burner control knob in and turn counterclockwise out of the OFF position -Fig. 1.
2. Release the knob and rotate to the **Lite** position.
3. Visually check that both inner and outer rings for the Double Ring burner are lit (See Fig. 3).
Once lit, push in the control knob and to turn counterclockwise out of the **Lite** position and adjust to the desired flame size.
4. When adjusting for a low or simmer type flame setting, continue to rotate the control knob counterclockwise from **MED** setting towards **LO** (See Fig 2). Between the **MED** and **LO** setting the flame for the outer ring portion of the burner will turn off leaving only the inner burner with a flame for simmering (See Fig. 4). Make any further flame adjustments as needed.

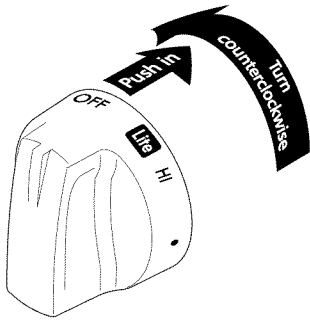

Fig. 1



Fig. 2

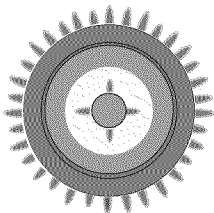

Fig. 3

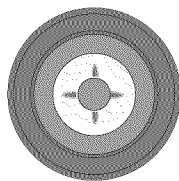

Fig. 4

⚠ CAUTION Do not place flammable items such as plastic salt and pepper shakers, spoon holders or plastic wrappings on the cooktop when it is in use. These items could melt or ignite. Potholders, towels or wooden spoons could catch fire if placed too close to the range cooktop.

⚠ CAUTION Do not place aluminum foil, or ANY material that can melt on the range cooktop. If these items melt they may permanently damage the cooktop surface.

Important notes:

- **DO NOT** cook with the surface control knob left in the LITE position. The electronic ignitor will continue to spark if the control knob setting remains in the LITE position .
- When setting any surface control knob to the LITE position, all electronic surface ignitors will spark at the same time. However, only the surface burner you are setting will ignite.
- **NEVER** place or straddle a cooking utensil over two different surface cooking areas at the same time. This can cause uneven heating results.
- In the event of an electrical power outage, the surface burners can be lit manually. Use caution when lighting surface burners manually. To light a surface burner, hold a lit match to the burner head, then slowly turn the surface control knob to LITE. After burner lights push in and turn knob to desired setting.

Home canning

Be sure to read and observe all the following points when home canning with your appliance. Check with the USDA (United States Department of Agriculture) website and be sure to read all the information they have available as well as follow their recommendations for home canning procedures.

- Use only quality flat bottom canners when home canning. Use a straight-edge to check canner bottom.
- Use only a completely flat bottom canner.
- Make sure the diameter of the canner does not exceed 1 inch beyond the surface element markings or burner.
- Start with hot tap water to bring water to boil more quickly.
- Use the highest heat setting when first bringing the water to a boil. Once boiling is achieved, reduce heat to lowest possible setting to maintain that boil.
- **NEVER** place or straddle a cooking utensil over two different surface cooking areas at the same time. This will cause uneven heating results.

Oven Control Functions

For satisfactory use of your oven, become familiar with the various keypad functions and features of the oven.

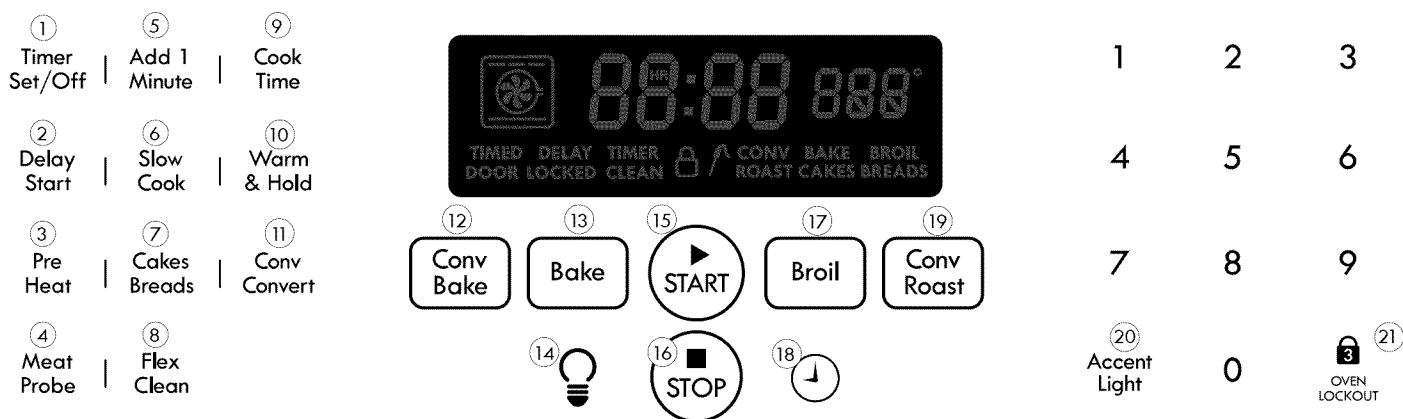

Oven control keypads

- 1. Timer Set/Off** - Use to set or cancel Timer.
 - 2. Delay Start** - Use with Bake, Conv Bake, Conv Convert and Flex Clean functions to program a delay start time or delay start self-cleaning cycle.
 - 3. PreHeat** - Use to pre-condition the oven temperature.
 - 4. Meat Probe** - Use to set meat probe.
 - 5. Add 1 Minute** - Use to add additional minutes to Timer.
 - 6. Slow Cook** - Use to set Slow Cook function.
 - 7. Cakes Breads** - Use to select Cakes or Breads function.
 - 8. Flex Clean** - Use to set a 2 to 4 hour self-clean cycle.
 - 9. Cook Time** - Use to enter length of cook time desired.
 - 10. Warm & Hold** - Use to select Warm & Hold function.
 - 11. Conv Convert** - Use to select Conv Convert function.
 - 12. Conv Bake** - Use to select Conv Bake function.
 - 13. Bake** - Use to start normal Bake function.
 - 14. Oven Light** - Use to turn the oven lights ON or OFF.
 - 15. START** - Use to start oven functions.
 - 16. STOP** - Use to cancel any oven function previously entered except Clock and Timer.
 - 17. Broil** - Use to select Broil function.
 - 18. Clock** - Use to set the time of day.
 - 19. Conv Roast** - Use to select Conv Roast function.
 - 20. Accent Light** - Use to turn Accent Light ON or OFF.
 - 21. Oven Lockout** - Use to lockout oven functions and door.
- 0-9 keypads** - Use to enter temperatures and times.

Minimum & maximum control settings

All of the features listed have minimum and maximum time and temperature settings that may be entered into the control. An ENTRY acceptance beep will sound each time a keypad is touched (the Oven Lockout keypad is delayed by 3 seconds).

An ENTRY ERROR tone (3 short beeps) will sound if the entry of the temperature or time is below the minimum or above the maximum settings for the feature.

Feature	Min. temp. or time	Max. temp. or time
PreHeat	170°F / 77°C	550°F / 288°C
Bake	170°F / 77°C	550°F / 288°C
Broil	400°F / 205°C	550°F / 288°C
Timer	1 minute	11 hrs. 59 minutes
Flex Clean	2 hours	4 hours
Conv Bake	300°F / 149°C	550°F / 288°C
Conv Convert	300°F / 149°C	550°F / 288°C
Conv Roast	300°F / 149°C	550°F / 288°C
Slow Cook	Lo (225°F / 108°C)	Hi (275°F / 134°C)
Cook Time	1 minute	11:59
Delay Time 12 Hr.	1:00	12:59
Delay Time 24 Hr.	0:00	23:59
Clock 12 Hr.	1:00	12:59
Clock 24 Hr.	0:00	23:59

Setting Oven Controls



Setting Clock

When the appliance is first powered up, 12:00 will flash in the display (See Fig. 1). The time of day must first be set before operating the oven.



Fig. 1

Example — To set the clock to 1:30:

1. Press  keypad.
2. Enter **1 3 0** using numeric keypads.
3. Press .

Important note:

The clock cannot be changed during any active oven cooking or cleaning function.

Setting Timer

The minute timer allows you to track your cooking times without interfering with the cooking process. The timer may be set from 1 minute up to 11 hours and 59 minutes.

Example — To set the timer for 5 minutes:

1. Press **Timer Set/Off** keypad.
2. Enter **5** using numeric keypad.
3. Press  keypad to start timer.

To cancel the timer when active press **Timer Set/Off** keypad again.

Important notes:

- The timer does not start or stop the cooking process. It serves as an extra minute timer in the kitchen that will beep when the set time has run out. The timer may be used alone or while using any of the other oven functions.
- The timer will display hours and minutes until 1 hour remains. When less than 1 hour remains, the display will count down in minutes and seconds. Once the timer has less than 1 minute remaining only seconds will display.
- When the timer is active during a cooking process, the minute timer will show in the display. To view the information of any other active oven function, press the keypad once for the other function to view the status.

Add 1 Minute

Use the **Add 1 Minute** keypad to set additional minutes to the timer. Each press of the keypad will add 1 additional minute. If Add 1 Minute keypad is pressed when the timer is not active, the timer will activate and begin counting down from 1 minute.

Example — To add 2 minutes to the timer:

Press **Add 1 Minute** keypad twice.

Setting 12 or 24 hour display mode

The clock display mode allows you to choose between 12 or 24 hr modes. The factory preset clock display mode is 12 hours.

Example — To set 12 or 24 hour display mode:



1. Press and hold  keypad for 6 seconds.
2. Press **Flex Clean** keypad to toggle between 12 Hr day or 24 Hr day display modes (See Figs. 2 & 3).
3. Press  to accept choice.



Fig. 2



Fig. 3

Changing between continuous bake setting or 12-Hour Energy Saving feature

The oven control has a factory preset built-in 12 Hour Energy Saving feature that will turn off the oven if the oven is left on for more than 12 hours. The control may be programmed to override this feature to continuously bake.

Example — To change between continuous bake or 12-Hour Energy saving feature:

1. Press and hold **Timer Set/Off** keypad for 6 seconds.
2. Press **Flex Clean** to toggle between 12 Hour OFF (Fig. 4) or Stay On (Fig. 5) feature.
3. Press  to accept choice.



Fig. 4



Fig. 5

Setting Oven Controls

Changing oven temperature display mode

The oven control is preset to display °F (Fahrenheit) when shipped from the factory. The control can be changed to display either Fahrenheit or Celsius.

Example — To change the temperature to display °C (Celsius) or °F (Fahrenheit):

1. Press and hold **Broil** keypad for 6 seconds.
2. Press **Flex Clean** keypad to toggle between Fahrenheit or Celsius temperature display modes (Figs. 1 & 2).
3. Press  to accept choice.

Important note:

The oven temperature display cannot be modified during any active oven cooking or cleaning function.



Fig. 1

Fig. 2

Setting silent or audible control mode

Silent mode allows the oven control to operate without audible tones. The control may be programmed for silent operation and later returned to operating with all the normal audible tones.

Example — To set for silent or audible mode:

1. Press and hold **Delay Start** keypad for 6 seconds.
2. Press **Flex Clean** keypad to toggle between beep on or beep off. (See Figs. 3 & 4).
3. Press  to accept choice.



Fig. 3

Fig. 4

Oven Lockout



The control may be programmed to lock the oven door and lock the oven control keypads.

To activate the Oven Lockout feature:

1. Be sure oven door is completely closed.
2. Press and hold the **OVEN LOCKOUT** keypad for 3 seconds. **door Loc** (See Fig. 5) will appear in the display. The motor driven door latch mechanism will begin locking the oven door automatically. Do not open the oven door. Allow about 15 seconds for the oven door to completely lock. Once the oven door is locked, the **Loc** will appear in the display (See Fig. 6).



Fig. 5



Fig. 6

To cancel the Oven Lockout feature:

1. Press and hold the **OVEN LOCKOUT** keypad for 3 seconds. The motor driven door latch mechanism will begin unlocking the oven door automatically. Do not open the oven door. Allow about 15 seconds for the oven door to completely unlock.
2. When the **Loc** message (Fig. 6) is no longer displayed, the oven door may be opened and the oven control keypads will be available for use.

Important notes:

- To avoid possible damage to the oven door latching mechanism, do not attempt to open or close the oven door whenever the door **Loc** message is displayed.
- If a control keypad is pressed when **OVEN LOCKOUT** is active, the control may triple beep indicating the keypad action is not available when the **OVEN LOCKOUT** feature is active.

Setting Oven Controls

Setting Preheat

For best baking performance use the **Preheat** feature. The Preheat feature will bring the oven up to the set cooking temperature. A reminder tone will sound indicating when the set temperature is reached and to place the food in the oven.

When the oven is finished preheating the preheat feature will perform like the Bake feature and continue to maintain the oven set temperature until cancelled.

Preheat may be set for any oven temperature between 170°F (77°C) to 550°F (288°C).

Example — To set Preheat with default oven temperature of 350°F:

1. Press **PreHeat** keypad.
2. Press  (See Fig. 1).



To cancel preheating at anytime press .



Fig. 1

Example — To set oven for Preheat to 450°F:

1. Press **PreHeat** keypad.
2. Press **4 5 0** using numeric keypads.
3. Press .

To cancel preheating at anytime press .

Important notes:

- Preheating is not necessary when roasting or cooking casseroles.

Setting Bake

Use the bake function whenever the recipe calls for baking using normal temperatures. A reminder tone will sound indicating when preheating is finished and to place the food in the oven.

Bake may be set for any oven temperature between 170°F (77°C) to 550°F (288°C).

CAUTION Always use pot holders or oven mitts when using the oven. When cooking, the oven interior, oven racks and cooktop will become very hot which can cause burns.

Example — To set Bake with default oven temperature of 350°F:

1. Press **Bake** keypad.
2. Press .

To cancel baking at anytime press .

Example — To set Bake for oven temperature of 425°F:

1. Press **Bake** keypad.
2. Enter **4 2 5** using numeric keypads.
3. Press .

To cancel baking at anytime press .

Important notes:

- Dark or dull pans absorb more heat than shiny bakeware resulting in dark or overbrowning of foods. It may be necessary to reduce the oven temperature or cook time to prevent overbrowning of some foods. Dark pans are recommended for pies. Shiny pans are recommended for cakes, cookies and muffins.
- The oven will bake no longer than 12 hours. If you wish to continuously bake, see **Changing between continuous bake setting or 12-Hour Energy Saving feature** for detailed information.

Setting Oven Controls

Setting Cook Time

Use Cook Time to program the oven control to automatically turn the oven function off after a desired length of time.

⚠ WARNING FOOD POISONING HAZARD. Do not let food sit for more than one hour before or after cooking. Doing so can result in food poisoning or sickness. Foods that can easily spoil such as milk, eggs, fish, meat or poultry, should be chilled in the refrigerator first. Even when chilled, they should not stand in the oven for more than 1 hour before cooking begins, and should be removed promptly when finished cooking.

Example — To program oven to Bake with oven default temperature of 350°F and to shut-off after 30 minutes:



1. Press **Cook Time** keypad.
2. Enter **3 0** using numeric keypads.
3. Press  to accept.
4. Press **Bake** keypad.
5. Press .



Fig. 1

When the programmed cook time runs out:

1. **END** will appear in the display window and the oven will shut-off automatically (See Fig. 1)
2. The oven control will provide a beep 3 times every 30 seconds as a reminder until  keypad is pressed.

Important notes:



- The Cook Time feature may be set with Bake, Conv Bake, Conv Roast, Slow Cook and Preheat. Cook Time or Delay Start will not operate with the Broil function.
- The maximum default Cook Time setting is 11 hours and 59 minutes.
- After the Cook Time feature has been activated, press the **Cook Time** keypad to display any cook time remaining.
- Dark or dull pans absorb more heat than shiny bakeware resulting in dark or overbrowning of foods. It may be necessary to reduce the oven temperature or cook time to prevent overbrowning of some foods. Dark pans are recommended for pies. Shiny pans are recommended for cakes, cookies and muffins.

Setting Delay Start

Delay Start sets a delayed starting time to oven cooking or cleaning functions. Prior to setting a delay start, be sure the time of day is set correctly.

⚠ WARNING FOOD POISONING HAZARD. Do not let food sit for more than one hour before or after cooking. Doing so can result in food poisoning or sickness. Foods that can easily spoil such as milk, eggs, fish, meat or poultry, should be chilled in the refrigerator first. Even when chilled, they should not stand in the oven for more than 1 hour before cooking begins, and should be removed promptly when finished cooking.

Example — To program oven for a delayed start beginning at 5:30 and to shut-off automatically after 50 minutes and for baking at 375 F:

1. Press **Cook Time** keypad.
2. Enter **5 0** using numeric keypads.
3. Press  to accept
4. Press **Delay Start** keypad.
5. Enter **5 3 0** using numeric keypads.
6. Press  to accept.
7. Press **Bake** keypad.
8. Enter **3 7 5** using numeric keypads.
9. Press .

When the programmed cook time runs out:

1. **END** will appear in the display window and the oven will shut-off automatically (See Fig. 1).
2. The oven control will provide 3 short beeps every 30 seconds as a reminder until  keypad is pressed.

Important notes:

- Delay Start may be set using a 24 hour clock. See Setting 12 or 24 hour display modes for more information.
- The Delay Start feature may be used with Bake, Conv Bake, Conv Roast, Conv Convert, Slow Cook and Flex Clean functions. Delay Start or Cook Time will not operate with the Broil function.

Setting Oven Controls

Conv Bake

Benefits of the convection bake feature

- Foods may cook up to 25 to 30% faster, saving time and energy.
- Multiple rack baking.
- No special pans or bakeware needed.

Convection functions use a fan to circulate the oven's heat uniformly and continuously around the oven. This improved heat distribution allows for fast, even cooking and browning results.

Heated air flows around the food from all sides, sealing in juices and flavors.

Most foods will cook faster and more evenly with the convection feature.

Conv Bake may be set for any oven temperature between 300°F (149°C) to 550°F (288°C).

Suggestions for Convection baking:

- Reduce oven temperature 25°F from recipe's recommended oven temperature. Follow the remainder of the recipe's instructions using the minimum recommended cook time.
- For best results when using a single oven rack, place rack in position 3 or 4 (See Fig. 1). When using 2 oven racks, place in positions 1 and 4. When using 3 oven racks place in positions 1, 3, and 6 (use offset oven rack only in position 6).

Example — To set Conv Bake with a default oven set temperature of 350°F:

1. Press **Conv Bake** keypad.
2. Press .

To cancel Conv Bake at anytime press .

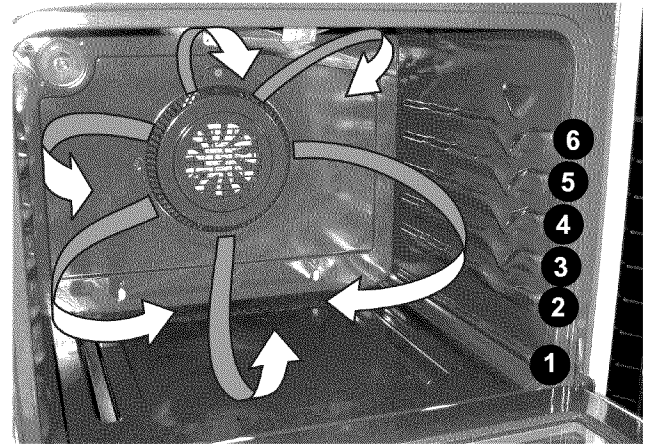

Fig. 1

Important notes:

- The convection fan will begin rotating **6 minutes** after Conv Bake, Conv Roast or Conv Convert has been activated.
- If the oven door is opened when any convection function is active and the convection fan is rotating, the convection fan will **stop rotating** until the oven door is closed.
- When using Conv Bake cook time reductions may vary depending on the amount and type of food being cooked.
- Layer cakes will have better results using the **Cakes Breads** function.
- Dark or dull pans absorb more heat than shiny bakeware resulting in dark or overbrowning of foods. It may be necessary to reduce the oven temperature or cook time to prevent overbrowning of some foods. Dark pans are recommended for pies. Shiny pans are recommended for cakes, cookies and muffins.

Setting Oven Controls

Conv Roast

The Conv Roast function combines a cook cycle with the convection fan to roast meats and poultry. Meats cooked with Conv Roast function will be juicer and poultry will be crisp on the outside while staying tender and moist on the inside.

Conv Roast may be set for any oven temperature between 300°F (149°C) to 550°F (288°C).

Suggestions for Conv Roast:

- Preheating is not necessary when roasting foods using Conv Roast.
- Since Conv Roast cooks food faster, reduce the cook time by 25% from the recommended cook time of your recipe (check the food at this time). If necessary, increase cook time until the desired doneness is obtained.
- Do not cover foods when dry roasting - this will prevent the meat from browning properly.

Example — To set Conv Roast with a default oven set temperature of 350°F:

1. Press **Conv Roast** keypad.

2. Press .

To cancel Conv Roast at anytime press .

Important notes:

- The convection fan will begin rotating **6 minutes** after Conv Bake, Conv Roast or Conv Convert has been activated.
- If the oven door is opened when any convection function is active and the convection fan is rotating, the convection fan will **stop rotating** until the oven door is closed.

Conv Convert

The Conv Convert function makes it easy to convert any baking recipe and include the convection feature. The oven control uses the normal recipe settings and **adjusts to a lower temperature** for convection baking.

When Conv Convert is used with a Cook Time setting, the Conv Convert function will display a **CF** (See Fig. 1) as a reminder to “check food” when the bake time is 75% complete. At this time the oven control will sound 1 long beep at regular intervals until the set cook time has finished.





Fig. 1

Example — To add Conv Convert to Conv Bake function using default oven set temperature:

1. Press **Conv Bake** keypad.
2. Press **Conv Convert** keypad.

To cancel Conv Convert at anytime press .

Example — To program oven for Conv Convert with oven default temperature of 350°F and to shut-off after 30 minutes:

1. Press **Conv Bake** keypad.
2. Press  to accept.
3. Press **Cook Time** keypad.
4. Enter **3 0** using numeric keypads.
5. Press  to accept.
6. Press **Conv Convert** keypad.

Important notes:

- Conv Convert may only be used with the **Conv Bake** function.
- When using Conv Convert function Cook Time reductions may vary depending on the oven set temperature.
- The minimum amount of Cook Time that may be entered using the Conv Convert function is 20 minutes.
- The convection fan will begin rotating **6 minutes** after Conv Bake, Conv Roast or Conv Convert has been activated.
- If the oven door is opened when any convection function is active and the convection fan is rotating, the convection fan will **stop rotating** until the oven door is closed.



Setting Oven Controls

Broil

Use the broil function to cook meats that require direct exposure to radiant heat for optimum browning results. The Broil feature is factory preset to broil at 550°F. The Broil function temperature may be set at any temperature between 400°F (205°C) and 550°F (288°C).

Be aware that the suggested broil settings table (Fig. 2) are recommendations only. Increase or decrease broiling times, or move to a different oven rack position to suit for doneness. If the food you are broiling is not listed in the table, follow the instructions provided in your cookbook and watch the item closely.

Example - To set Broil with the default broil oven temperature of 550°F:

1. Arrange the oven racks when cool. For optimum browning results, you may preheat oven for 5 minutes before adding food.
2. Position cookware in oven. **Close the oven door.**
3. Press **Broil** key pad.
4. Press .
5. Broil on one side until food is browned; turn and broil on other side.
6. When finished broiling press .

To cancel Broil at anytime press .

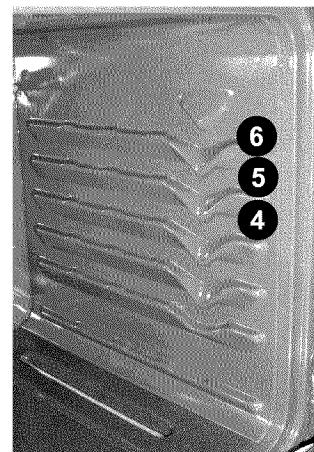

Fig. 1

⚠ WARNING Should an oven fire occur, close the oven door and turn the oven OFF. If the fire continues, use a fire extinguisher. **DO NOT** put water or flour on the fire. Flour may be explosive.

⚠ CAUTION Always use pot holders or oven mitts when using the oven. When cooking, the oven interior, exterior, oven racks and cooktop will become very hot which can cause burns

Important notes:

- Always arrange oven racks when the oven is cool.
- For best results when broiling, use a quality broil pan along with a broil pan insert. A broil pan is designed to drain the fat from the food, help avoid spatter and reduce smoking.
- When broiling, always pull the oven rack out to the stop position before turning or removing food.
- Cook Time or Delay Start will not operate with the Broil function.

Suggested broil settings table (gas oven)

Food	Rack position (See Fig. 1)	Setting	Cook time in minutes		Doneness
			1st side	2nd side	
Steak 1" thick	5th or 6th*	550°	8	6	Medium
Steak 1" thick	5th or 6th*	550°	10	8	Medium-well
Steak 1" thick	5th or 6th*	550°	11	10	Well
Pork chops 3/4" thick	5th	550°	12	8	Well
Chicken-bone in	4th	450°	25	15	Well
Chicken-boneless	5th	450°	10	8	Well
Fish	5th	550°	- as directed -	-	Well
Shrimp	4th	550°	- as directed -	-	Well
Hamburger 1" thick	5th or 6th*	550°	12	10	Medium
Hamburger 1" thick	5th	550°	14	12	Well

Cook times provided are approximate and should be used only as a guide.

*Use the off-set rack only in oven rack position 6.

Fig. 2

Setting Oven Controls

Cakes Breads

The **Cakes Breads** functions are designed to give optimum baking performance for Cakes or Breads. These functions work well for baking cakes, brownies, pies (fresh or frozen), baked custards, cheesecakes, breads, rolls, biscuits, muffins and cornbread.

The **Cakes** function provides a preheat with a gentle cycling of heat giving cakes more volume and allowing delicate foods to cook more evenly.

The **Breads** function adds a special preheat feature to the bake cycle that thoroughly heats the oven from top to bottom to give more evenly browned foods.

Example - To set the Cakes or Breads features:

1. Arrange interior oven racks when cool. If needed Preheat oven as desired and place food in oven.
2. For Cakes, press the **Cakes Breads** keypad until **CAKES** appears in the oven control display (See Fig. 1).

For Breads, press the **Cakes Breads** keypad until **BREADS** appears in the oven control display (See Fig. 2).

3. Press .

Press  to cancel **Cakes** or **Breads** function at any time.

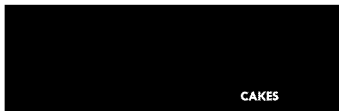

Fig. 1



Fig. 2

Important notes:

- Dark or dull pans absorb more heat than shiny bakeware resulting in dark or overbrowning of foods. It may be necessary to reduce the oven temperature or cook time to prevent overbrowning of some foods. Dark pans are recommended for pies. Shiny pans are recommended for cakes, cookies and muffins.
- Breads will have better results baking on a single oven rack.
- Layer cakes will have best results using the Cakes function.

Baking layer cakes with 1 or 2 oven racks

For best results when baking cakes or cookies using 2 oven racks, place cookware on rack in positions 2 and 4 (5 if using the offset oven rack). For best results when baking cakes or cookies using a single oven rack, place offset oven rack in positions 2 or 3.

Meat probe (some models)

When cooking meat such as roasts, hams or poultry, use the meat probe function to check the internal temperature without any guesswork. For some foods, especially poultry and roasts, testing the internal temperature is the best method to insure properly cooked meats.

Important notes:

- Use **ONLY** the meat probe supplied with appliance. Using any other probe or device may result in damage to appliance and the meat probe receptacle.
- Never leave or store meat probe inside oven.
- Handle the meat probe carefully when inserting and removing from food or probe receptacle. Do not use tongs to pull on meat probe cable when inserting or removing from food or receptacle.
- Defrost food completely before inserting meat probe to avoid damaging probe.
- To avoid possibility of burns, after cooking carefully unplug meat probe using a pot holder to protect hands.

Proper meat probe placement:

- Always insert meat probe so that the probe tip rests in the center of the thickest part of meat. Do not allow meat probe to touch bone, fat, gristle or cookware.
- For bone-in ham or lamb, insert meat probe into the center of lowest large muscle or joint. For dishes such as meat loaf or casseroles, insert meat probe into center of food. To find center of the food visually measure using probe as a guide (See Fig. 3). When cooking fish, insert meat probe just above the gill.
- For whole poultry or turkey, insert meat probe into the thickest part of inner thigh, below the leg (See Fig. 4).

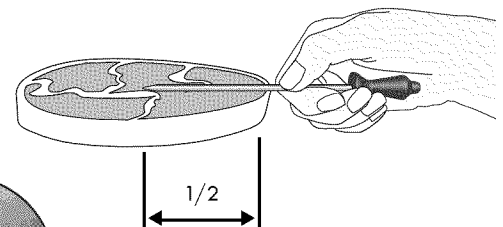

Fig.3

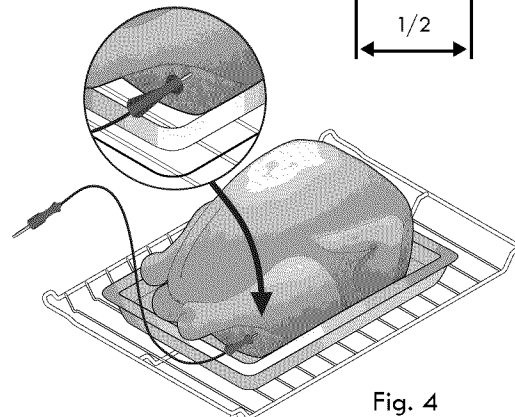

Fig. 4



Setting Oven Controls

Meat probe (cont'd)

Important note:

Changing how the oven reacts after reaching the target temperature must be done before starting the cooking process.

To set meat probe:

1. Prepare the food and properly insert the temperature probe into the food. **DO NOT preheat** or start cooking **before** properly inserting the meat probe. The probe should be inserted into the food and receptacle while the oven is still cool.
2. Place the prepared food on the desired oven rack position and slide into the oven.
3. Plug the meat probe into the probe receptacle located on the left front oven cavity side (See Fig. 1 for location of probe receptacle).
4. The oven control detects if the meat probe is correctly plugged in to receptacle and when recognized will illuminate the  icon in the oven control display.
5. To set the target temperature press **Meat Probe** keypad once then enter the desired target internal temperature using the numeric key pads (default setting is 170°F/77°C)†. Press  to accept the meat probe target temperature. Close the oven door.
6. Set the oven control for **Bake**, **Conv Bake** or **Conv Roast** and the desired oven temperature. You may use the meat probe with some other baking features, but the meat probe cannot be set with **Broil** or **Flex-Clean**.
7. During the cooking process the actual meat probe temperature will display by default. To view the target temperature press the **Meat Probe** keypad once. After 6 seconds the display will show the actual meat probe temperature. If the target temperature needs to be changed during the cooking process, press the **Meat Probe** keypad once and use the numeric keypads to adjust the target temperature. Press the  key to accept any change.
8. The oven control will provide 3 beeps when the internal target temperature is reached. By default the oven will automatically change to a Warm & Hold setting. The Warm & Hold function will maintain the oven temperature at 170° F (77°C). Instructions for changing how the oven reacts after reaching the internal target temperature may be found later in this section.

Press  to cancel cooking at any time.

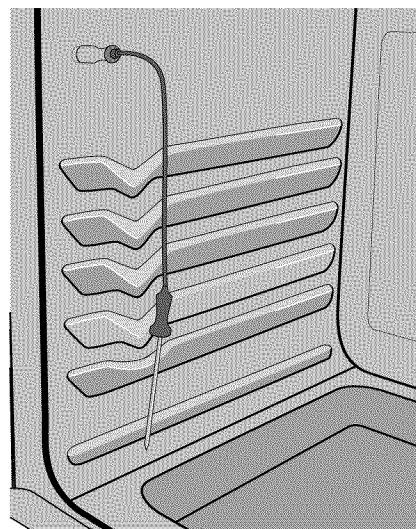



Fig. 1

See the following Instructions for changing how the oven reacts after reaching the internal target temperature.

To set the oven to continue cooking after reaching the probe target temperature:

1. Press **Meat Probe** keypad and hold for 6 seconds.
2. Press **Flex Clean** keypad and toggle until the “Continu” message appears (Fig. 2) then press  to accept.

To set the oven to cancel cooking and automatically start Warm & Hold after reaching the probe target temperature:

1. Press **Meat Probe** keypad and hold for 6 seconds.
2. Press **Flex Clean** keypad and toggle until “CANCEL” message appears (Fig. 3) then press  to accept.



Fig. 2



Fig. 3

† The U.S. Department of Agriculture states, “Rare fresh beef is popular, but you should know that cooking it to only 140°F/60°C means some food poisoning organisms may survive.” (Source: Safe Food Book, Your Kitchen Guide, USDA Rev. June 1985.)

The lowest temperature recommended by the USDA is 145°F/63°C for medium rare fresh beef.

Setting Oven Controls

Setting Slow Cook

The Slow Cook function may be used to cook foods more slowly and at lower oven temperatures. Slow Cook provides cooking results much the same way as a Slow Cooker or Crock-Pot.

Slow Cook is ideal for roasting beef, pork & poultry. Slow cooking meats may result in the exterior of meats becoming dark but not burnt. This is normal.

For Slow Cook two settings are available, high (**Hi**) or low (**Lo**). The high setting is best for cooking foods from a 4 to 5 hour time period. The low setting is best for cooking foods from a 8 to 9 hour time period.

Some tips for best results when using Slow Cook:

- Completely thaw all frozen foods before cooking with the Slow Cook.
- When using a single oven rack, place in oven rack position 2 or 3.
- Position multiple racks to accommodate size of cooking utensils when cooking multiple food items.
- Do not open the oven door often or leave the door open when checking foods. If the oven heat escapes often, the Slow Cook time may need to be extended.
- Cover the foods to keep them moist or use a loose or vented type cover to allow foods to turn crisp or brown.
- Roasts may be left uncovered so browning can occur. Cook times will vary; depending on the weight, fat content, bone & the shape of the roast.
- Use the recipe's recommended food temperature and a food thermometer to determine when the food is done.
- Preheating the oven will not be necessary when using the Slow Cook feature.
- Add any cream or cheese sauces during the last hour of cooking.

⚠ WARNING FOOD POISONING HAZARD. Do not let food sit for more than one hour before or after cooking. Doing so can result in food poisoning or sickness. Foods that can easily spoil such as milk, eggs, fish, meat or poultry, should be chilled in the refrigerator first. Even when chilled, they should not stand in the oven for more than 1 hour before cooking begins, and should be removed promptly when finished cooking.

Example — To set Slow Cook:

1. Position cookware in oven and close oven door.
2. Press **Slow Cook** keypad. Hi will appear in the display indicating the default temperature setting is for high.
3. If a low setting is needed, press **Slow Cook** keypad again to select the low setting.
4. Press  to activate Slow Cook.

To cancel Slow Cook at anytime press .

Important notes:

- Slow Cook may be used with additional settings of Cook Time and Delay Start.
- The maximum cook time for the Slow Cook is 11 hours and 59 minutes unless the control has been changed to the continuous Bake mode.

Setting Oven Controls

Warm & Hold™

Warm & Hold will keep cooked foods warm for serving up to 3 hours after cooking has finished. After 3 hours the Warm & Hold will shut-off automatically. Warm & Hold should only be used with foods that are already at serving temperatures. Warm & Hold will maintain the oven temperature at 170° F (77°C).



⚠ WARNING FOOD POISONING HAZARD. Do not let food sit for more than one hour before or after cooking. Doing so can result in food poisoning or sickness. Foods that can easily spoil such as milk, eggs, fish, meat or poultry, should be chilled in the refrigerator first. Even when chilled, they should not stand in the oven for more than 1 hour before cooking begins, and should be removed promptly when finished cooking.

Example — To set Warm & Hold:

1. If needed, arrange interior oven racks and place cooked food in oven.
2. Press **Warm & Hold** keypad. **HLd** will appear in the display. If no further keypads are touched within 25 seconds the request for Warm & Hold will clear.
3. Press . Warm & Hold will automatically turn off after 3 hours.

To turn Warm & Hold off at any time press .

Example — To add Warm & Hold to turn ON automatically after baking 45 minutes with default oven set temperature of 350°F:

1. Press **Cook Time** keypad.
2. Enter **4 5** using numeric keypads.
3. Press  to accept.
4. Press **Bake** keypad.
5. Press  to accept.
6. Press **Warm & Hold** keypad. **HLd** will appear in the oven control display.
7. Press  to accept. When the cook time runs out, the Warm & Hold will turn ON automatically. Warm & Hold will automatically turn off after 3 hours.





Important notes:

- Warm & Hold will maintain the oven temperature at 170° F (77°C) for 3 hours.
- Warm & Hold may be set when finished cooking or may be added to automatically turn on after cooking using Cook Time. Delay Start may also be added.

Recipe Recall

The Recipe Recall feature may be used to record and recall your favorite recipe settings. This feature allows you to store one setting for each of the basic cooking keypads. The keypads that a recipe may be stored with are **Bake, Conv Bake, Conv Roast, Cakes Breads, PreHeat** and **Slow Cook**. This feature will also store and recall any added Cook Time or Warm & Hold settings.

Example - To store a typical cookie recipe for baking at 375°F for 9 minutes and to shut-off automatically:

1. Close oven door.
2. Press **Bake** keypad.
3. Press **3 7 5** numeric keypads.
4. Press .
5. Press **Cook Time** keypad.
6. Enter the desired baking time. Press **9** numeric keypad.
7. Press and hold  keypad until acceptance tone sounds (about 3 seconds). The recipe will now be stored with the **Bake** keypad for future recall. If you wish to store the recipe but not start the oven at this time press  after pressing the  keypad.

Example - To recall the cookie recipe previously stored with the Bake keypad:

1. Arrange interior oven racks when cool.
2. Press **Bake**. The previously stored recipe with the **Bake** keypad will be recalled.
3. Press .

Important notes:

- Once a recipe has been stored with a keypad the recipe information will be recalled when pressing the corresponding keypad in the future.
- If a recalled recipe includes Cook Time the oven will automatically shut-off when the Cook Time is finished.
- To erase all recipes stored see section for **Restoring factory default settings**.

Setting Oven Controls

Operating oven lights

The interior oven lights will automatically turn ON when the oven door is opened.

Press  to turn the interior oven light ON and OFF whenever the oven door is closed.

The interior oven lights are located on the rear wall of the oven interior and are covered with a glass shield. The glass shield protects the bulb from high temperatures and should always be in place whenever the oven is in use.

To replace the interior oven lights, see **Replacing oven lights** in the Care & Cleaning section.

Accent light

Your appliance includes a decorative Accent light centered horizontally behind the touch-sensitive control panel. The Accent light provides a theatre style intensity feature that slowly increases brightness at turn on and slowly fades when turning off.

When the Accent light is off, the light is in automatic mode by default. This means the Accent light will turn on automatically when an oven, cooktop function or features such as the Timer have been activated. The Accent light will turn off automatically when these functions or features are no longer active.

When the Accent light is OFF, it may be manually turned ON by pressing the **Accent Light** keypad once. When the Accent light has been manually turned on, it will remain on until manually turned off by pressing the **Accent Light** keypad again.

The brightness of the Accent light may also be adjusted.

Example - To adjust Accent light brightness:

1. Press and hold the **Accent Light** keypad until an acceptance tone sounds (about 6 seconds).
2. The default brightness setting of 100 will appear in the display (Fig. 1).
3. Using the numeric keypads, enter any digit from **0** to **100** to change the brightness level. Entering **0** (Fig. 2) will effectively turn the Accent light OFF until the brightness level is adjusted to a higher level.
4. Press  to save the desired brightness setting.



Fig. 1



Fig. 2

Setting Oven Controls

Adjusting oven temperature

Your appliance has been factory calibrated and tested to ensure an accurate baking temperature. For the first few uses, follow your recipe times and temperature recommendations carefully. If you think the oven is cooking too hot or too cool for your recipe times, you may adjust the control so the oven cooks hotter or cooler than the oven temperature displayed.

The oven temperature offset may be increased as much as +35°F (+19°C) or decreased -35°F (-19°C) from the factory calibrated settings.

Example — To increase (+) or decrease (-) the oven temperature by 20°F:

1. Press and hold **Bake** keypad until the control provides the 2nd audible tone (about 6 seconds).
2. Enter **2 0** using numeric keypad.
3. Press **Flex Clean** keypad to toggle between plus (+) if increasing temperature or minus (-) if decreasing the temperature. These symbols will show in the display.
4. Press  to accept change.

Important notes:

- Oven temperature adjustments made will not change the Broil or Flex Clean function temperatures.
- If the temperature shows an adjustment of -20°F, and a +20°F adjustment is needed, you can toggle between the minus (-) or plus (+) in the display when pressing **Flex Clean** keypad (See step 3).
- **DO NOT USE** oven thermometers such as those found in grocery stores to check the temperature settings inside your oven. These oven thermometers may vary as much as 20 to 40°F from actual temperatures.
- The oven temperature adjustment may be made if your oven control has been set to display °C (Celsius) temperatures. Minimum and maximum settings for Celsius are plus (+) or minus (-) 19°C.

Restoring factory default settings

When new, your appliance was set with predetermined oven control settings. Over time, the user may make changes to these default settings. The following features or functions have user options or adjustments that may have been changed from the factory default settings:

- 12 or 24 hour display mode
- Continuous bake or 12-Hour Energy Savings mode
- Silent or audible control
- Oven temperature display (Fahrenheit or Celsius)
- Oven temperature adjustments
- All stored recipes
- Meat Probe settings
- Accent Light brightness setting

Please be aware before restoring to factory default settings that **ALL** of the above user settings will be restored, including any oven temperature offset and any stored recipe information.

Example — To restore to factory default settings:

1. Press and hold the **7** numeric keypad until acceptance tone sounds (about 6 seconds).
2. Press . The control will reset all user preference settings back to factory default settings.

Setting Oven Controls

Sabbath feature (for use on the Jewish Sabbath & Holidays)



For further assistance, guidelines for proper usage and a complete list of models with the Sabbath feature, please visit the web at <http://www.star-k.org>.

The **Cook Time** and **Delay Start** keypads are used to set the Sabbath feature. The Sabbath feature may only be used after the **Bake** function is active.

Once the oven is properly set using the **Bake** function and the Sabbath mode is active, the oven will remain continuously ON until the Sabbath feature is cancelled. The Sabbath feature will override the factory preset 12-Hour Energy Saving feature and start the continuous bake mode.

⚠ WARNING FOOD POISONING HAZARD. Do not let food sit for more than one hour before or after cooking. Doing so can result in food poisoning or sickness. Foods that can easily spoil such as milk, eggs, fish, meat or poultry, should be chilled in the refrigerator first. Even when chilled, they should not stand in the oven for more than 1 hour before cooking begins, and should be removed promptly when finished cooking.

Example — To program the oven to Bake at default oven temperature of 350°F and activate the Sabbath feature:







1. Be sure the clock is set with the correct time of day.
2. Arrange oven racks, place cookware in oven and close oven door.
3. Press **Bake** keypad.
4. Press .
5. If Cook Time or Delay Start are not needed, **skip this step and continue to step 6.** If a Cook Time or Delay Start are desired enter the times at this point. Refer to the Cook Time and Delay Start sections for detailed instructions.
6. Press and hold both **Cook Time** and **Delay Start** keypads simultaneously for about 3 seconds to set the Sabbath feature. Once the feature is set **SAb** (See Fig. 1) will appear in the display indicating the oven is properly set for the Sabbath feature.



Fig. 1

Important notes:

- It is not advised to attempt to activate any other oven function except Bake while the Sabbath feature is active. ONLY the following keypads will function correctly when the Sabbath feature is active: **0-9** number keypads, **Bake**,  and . ALL OTHER KEYPADS should not be used once the Sabbath feature is activate.
- You may change the oven temperature once baking has started. Press **Bake** keypad, use the numeric keypads to enter the oven temperature change (170 to 550°F) and press  (for Jewish Holidays only). Remember that the oven control will no longer provide audible tones or display any further changes once the Sabbath feature is active.
- It is recommended that any oven temperature change with the Sabbath feature active be followed with two presses of the  keypad. This will insure the oven remains ON even if the attempt to set the oven temperature was lower or higher than the oven control can accept. If the oven temperature is set incorrectly, the oven temperature will default to 170°F or 550°F. Try to set the desired oven temperature again.
- If the oven light is needed during the Sabbath, press the  keypad to turn oven light on **before** activating the Sabbath feature. Once the oven light is turned on and the Sabbath feature is active, the oven light will remain on until the Sabbath feature is turned OFF. If the oven light needs to be off, be sure to turn the oven light off **before** activating the Sabbath feature.
- Remember the oven will shut-off automatically after completing a **Cook Time**, **Delay Start** or **Warm & Hold** and therefore may only be used once during the Sabbath/Jewish Holidays.
- If a Delay Start time longer than a maximum of 11 hours and 59 minutes in advance is desired, set the oven control for the 24 hour day display mode setting. For detailed instructions see **Setting 12 or 24 hour display modes**.
- The Accent light will not operate while the Sabbath feature is active.

Setting Oven Controls

Sabbath feature (for use on the Jewish Sabbath & Holidays)

Example - to turn the oven off and keep the Sabbath feature active:

Press .

Example — To turn off the Sabbath feature:

Press and hold both **Cook Time** and **Delay Start** key pads simultaneously for at least 3 seconds to turn the Sabbath feature off. The control will provide an acceptance tone and **SAb** will disappear from the display. The oven is no longer programmed for the Sabbath feature.

What to do during a power failure or power interruption after the Sabbath feature was activated:

Should you experience a power failure or interruption, the oven will shut-off. When power is restored the oven will not turn back on automatically. The oven will remember that it is set for the Sabbath and the oven display will show the message **SF** for Sabbath failure (Fig. 1).



Fig. 1

The food may be safely removed from the oven while still in the Sabbath feature, however the oven cannot be turned back on until after the Sabbath/Holidays. After the Sabbath observance turn OFF the Sabbath feature. Press and hold both **Cook Time** and **Delay Start** keypads for at least 3 seconds simultaneously to turn the Sabbath feature off. **SF** will disappear from the display and the oven may be used with all normal functions.

Warmer Drawer

Warm & Ready™ drawer (some models)

The purpose of the warmer drawer is to keep hot cooked foods at serving temperatures. Examples are vegetables, gravies, meats, casseroles, biscuits, rolls and pastries. It is not recommended to heat cold food in the warmer drawer; always start with hot food.

The warmer drawer may also be used to warm dinner plates. All food items placed in the warmer drawer should be covered with a lid or aluminum foil to maintain quality.

⚠ WARNING FOOD POISONING HAZARD. Do not let food sit for more than one hour before or after cooking. Doing so can result in food poisoning or sickness. Foods that can easily spoil such as milk, eggs, fish, meat or poultry, should be chilled in the refrigerator first. Even when chilled, they should not stand in the oven for more than 1 hour before cooking begins, and should be removed promptly when finished cooking.

⚠ WARNING Storage in or on appliance—flammable materials should not be stored in an oven, warmer drawer, near surface units. This includes paper, plastic and cloth items, such as cookbooks, plasticware and towels, as well as flammable liquids. Do not store explosives, such as aerosol cans, on or near the range.

⚠ WARNING DO NOT LEAVE CHILDREN ALONE — children should not be left alone or unattended in the area where appliance is in use. They should never be allowed to sit or stand on any part of the appliance, including the warmer drawer.

⚠ CAUTION Always use potholders or oven mitts when removing food from the warmer drawer as cookware and plates will be hot and you can be burned.

Important note:

The warmer drawer is equipped with a catch that may require extra force to open and close the drawer.

Arranging warmer drawer rack positions

The keep warmer drawer rack may be used in 2 ways:

- In the **upright position** (See Fig. 1) to allow low profile food items to be placed both under and on top of the rack (for example, rolls or biscuits on top of the rack and a casserole dish underneath).
- In the **downward position** (See Fig. 2) to allow for light weight food items and empty cookware (for example, rolls or pastries and dinner plates) on the rack.

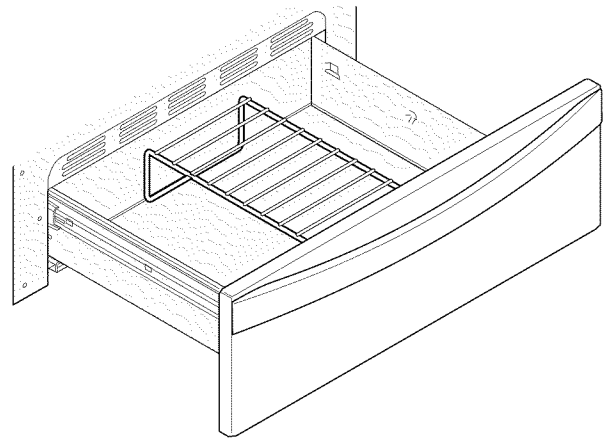

Fig. 1

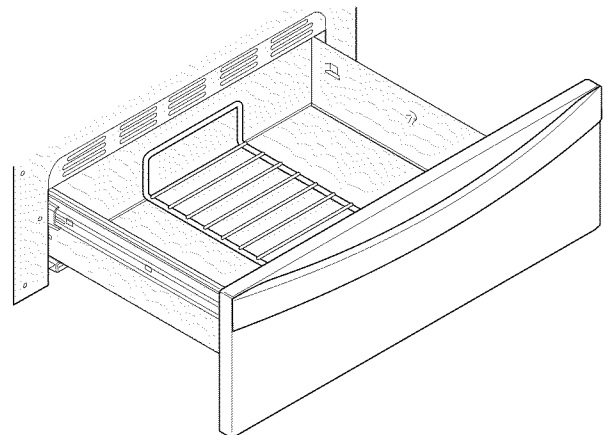



Fig. 2

Warmer Drawer

Warmer drawer controls

The warmer drawer controls are located on the control panel. Use the warmer drawer control keypads to turn the warmer drawer ON and OFF and make temperature adjustments. Five available heat settings are provided from low to high (See Fig. 2).

Warmer drawer indicator light

The warmer drawer indicator light is located beside the warmer drawer  keypad (See Fig. 1). It glows when the warmer drawer is turned ON, and remains on until the warmer drawer is turned OFF.

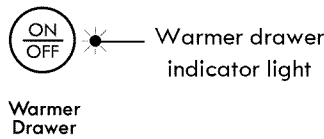



Fig. 1

CAUTION Always use potholders or oven mitts when removing food from the warmer drawer as cookware and plates will be hot and you can be burned.

To set warmer drawer:

1. Arrange the warmer drawer rack (if needed) in warmer drawer and place the cooked food or dishes in the warmer drawer. Close warmer drawer.
2. To activate press and hold the warmer drawer  keypad until acceptance tone sounds.
3. To set heat level press **Hi** or **Lo** keypad and if needed toggle using these keypads to adjust to the desired power level setting. Release keypad when the desired heat level is displayed by the indicator lights. Fig. 2 shows examples for low, medium and high settings.
4. Once warming is finished, press  to turn warmer drawer OFF and carefully remove items.

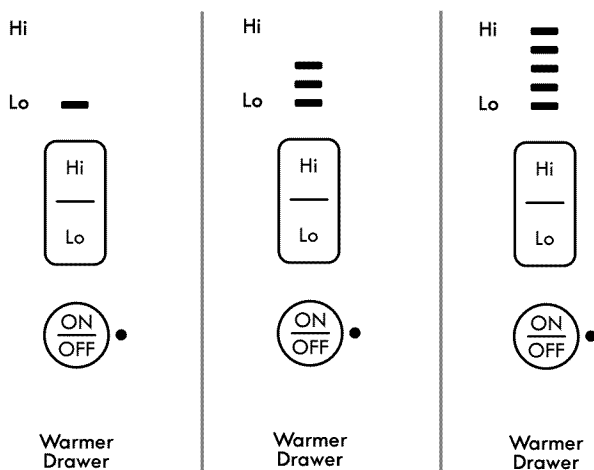

Fig. 2

Warmer drawer settings

The recommended warmer drawer food settings are shown in Fig. 3. The settings provided are meant to be used as a recommendation only. If a particular food item is not listed, start with a medium setting. If more crispness is desired, remove the lid or aluminum foil from the food.

Most foods may be maintained at serving temperatures using a medium heat setting. When a combination of foods are to be kept warm (for example, a meat with 2 vegetables and rolls) use a high setting.

Warmer drawer recommended food settings

Food Item	Setting
Bacon	Hi
Hamburger patties	Hi
Poultry	Hi
Pork chops	Hi
Fried foods	Hi
Pizza	Hi
Gravies	medium
Casseroles	medium
Eggs	medium
Roasts (beef, pork or lamb)	medium
Vegetables	medium
Biscuits	medium
Rolls (hard)	medium
Pastries	medium
Rolls (soft)	Lo
Empty dinner plates	Lo

Fig. 3

Important notes:

- **Do not use plastic wrap to cover food.** Plastic may melt on warmer the drawer and be very difficult to clean up. Only use utensils and cookware recommended by the manufacturer for use in the warmer drawer.
- Always start with hot food when using the warmer drawer. **DO NOT** heat cold food in the warmer drawer.
- To minimize heat loss, avoid opening warmer drawer frequently while in use.
- Flex Clean can not be set when the warmer drawer is active.
- If Proof Bread indicator light turns on when setting the heat level press **Hi** keypad once to toggle back to the warmer drawer settings.

Warmer Drawer

Proof Bread

The warmer drawer has a **Proof Bread** feature that may be used to prepare bread dough. The recommended length of time to keep the bread dough in the warmer drawer is about 45-60 minutes. Be sure however to follow the recipe's recommended times.

Since the bread dough will nearly double in volume be sure to place the prepared dough in a large bowl. Arrange the warmer drawer rack in the downward position (See Fig. 1) and place the bowl with dough on the warmer drawer rack.

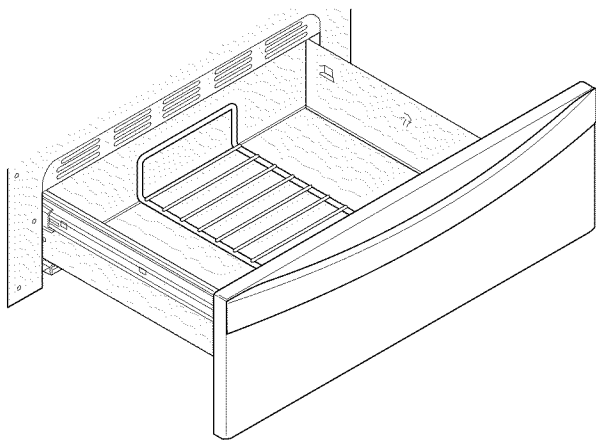



Fig. 1

To set Proof Bread using warmer drawer:

1. Arrange the warmer drawer rack in warmer drawer (See Fig. 1) and place bread dough in a large bowl on warmer drawer rack. Close warmer drawer.
2. Press  keypad to turn ON warmer drawer.
3. Press **Lo** keypad once set warmer drawer to **Lo** power setting.
4. Press **Lo** keypad again to activate **Proof Bread** feature. The Proof Bread indicator light will glow when the Proof Bread feature is active (See Fig. 2).
5. When the bread dough is ready, press the  keypad to turn the warmer drawer off and remove bread dough from warmer drawer.

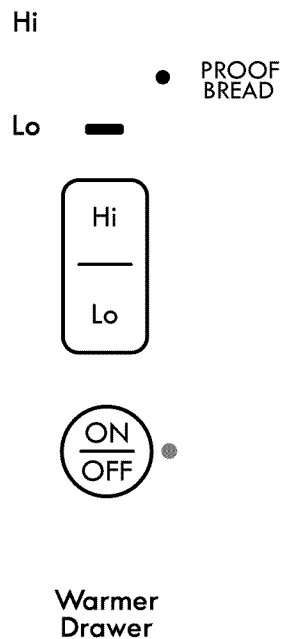

Fig. 2

Warmer Drawer

Removing and replacing the warmer drawer

⚠ WARNING Electrical shock hazard can occur and result in serious injury or death. Disconnect appliance from electric power before cleaning and servicing the warmer drawer.

To remove the warmer drawer:

1. Turn power OFF to the appliance **before** removing the warmer drawer.
2. Open the warmer drawer completely.
3. On left warmer drawer rail, locate black release lever and press up with finger while pulling out slightly on the oven drawer handle. On right warmer drawer rail, locate black release lever and press down with finger while pulling out slightly on the warmer drawer handle (See Fig. 1).
4. The warmer drawer should now be released from the rails. Remove warmer oven drawer (using level & square motion) completely out and away from the appliance.

To replace the warmer drawer:

1. Pull the bearing glides to the front of the outer compartment glide channels until they snap into place (See Fig. 3).
2. Carefully line up both sides of the warmer drawer glide rails to the outer compartment glide channels located inside the empty warmer drawer compartment (See Fig. 2).
3. While holding the warmer drawer level and square using the warmer drawer handle, push (**do not force**) the warmer drawer all the way into the outer compartment glide channels all the way into the range. Open the warmer drawer again to verify the glides have seated.
4. If you do not hear the levers “click” or the bearing glides do not feel seated remove the warmer drawer and repeat steps 1 through 3 again. This will minimize possible damage to the bearing glides.

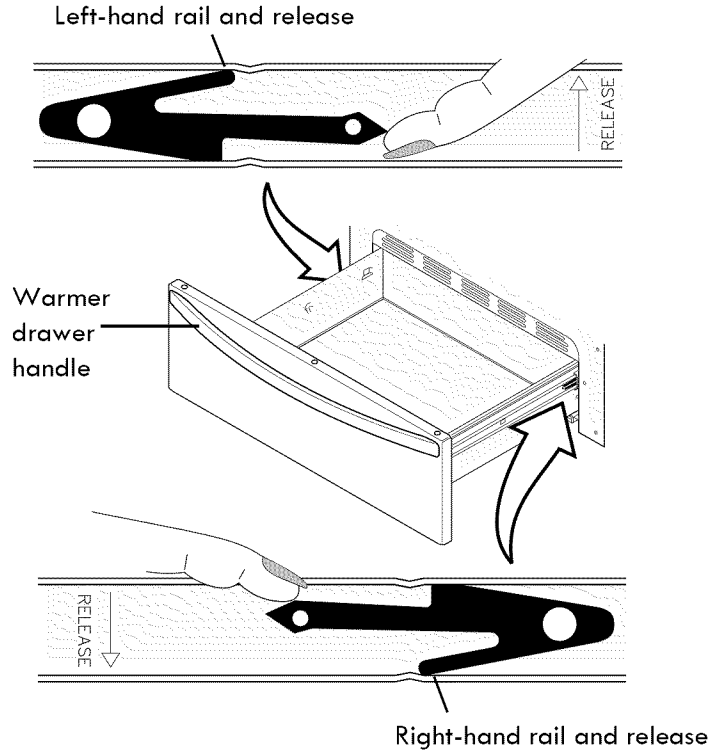

Fig. 1

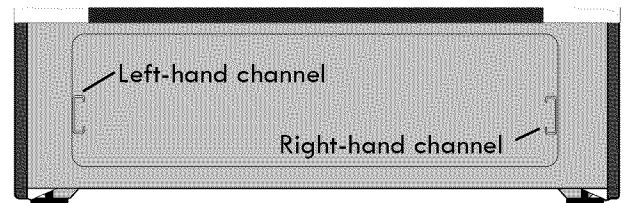
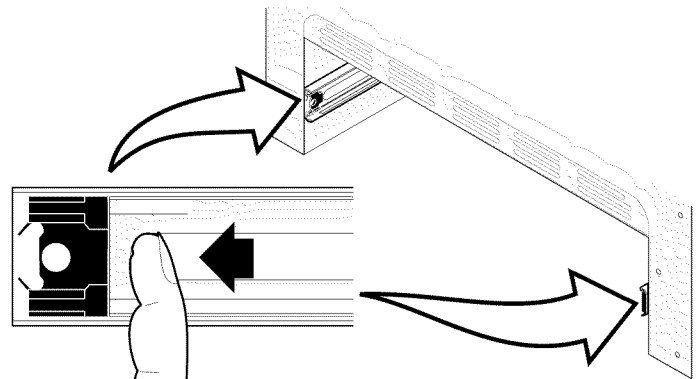

Fig. 2



Flex Clean

A self-cleaning oven cleans itself with high temperatures that are well above normal cooking temperatures. The high cleaning temperature eliminates soils completely or reduces them to a fine powdered ash you can wipe away afterwards with a damp cloth.

The Flex Clean function allows you to set any amount of cleaning time from 2 hours to 4 hours. A 3-hour cleaning time is best used for normal cleaning; 2-hour time for light soils and a 4-hour clean time for heavier stubborn soils.

Read before starting Flex Clean

Be sure to read all the following caution and important statements **BEFORE** starting a self-clean cycle:

⚠ CAUTION DO NOT leave small children unattended near the appliance. During the self-cleaning cycle, the outside of the range can become very hot to touch and can cause burns.

⚠ CAUTION DO NOT line the oven walls, racks, bottom or any other part of the range with aluminum foil. Doing so will destroy heat distribution, produce poor baking results and cause permanent damage to the oven interior. Aluminum foil will melt to the interior of the oven.

⚠ CAUTION The health of some birds is extremely sensitive to the fumes given off during the self-cleaning cycle of any range. Move birds to another well-ventilated room.

⚠ CAUTION DO NOT force the oven door open. This can damage the automatic door locking system.

⚠ CAUTION Use caution when opening the oven door after self-cleaning. **The oven may still be VERY HOT** and can cause burns. To avoid possible burns stand to the side of the oven when opening the oven door to allow hot air or steam to escape.

Important notes:

- Completely **remove all items and accessories from oven cavity to avoid damage**. Porcelain coated heavy duty oven racks may be left in oven.
- Remove ALL items from the cooktop including cookware, utensils and **ANY ALUMINUM FOIL**. Aluminum foil will not withstand high temperatures from a self-clean cycle and can melt.
- **DO NOT** use oven cleaners or oven protective coatings in or around any part of the oven interior.
- Clean any soil from the oven frame, the door liner outside the oven door gasket and the small area at the front center of the oven bottom (See Fig. 1). These areas heat sufficiently to burn soil on. Clean using soap and water prior to starting Flex Clean (See Fig. 1).

- Remove any excessive spillovers. Any spills on the oven bottom should be wiped-up and removed before starting a self-clean cycle. To clean, use hot, soapy water and a cloth. Large spillovers can cause heavy smoke or fire when subjected to high temperatures. **DO NOT** allow food spills with a high sugar or acid content (such as milk, tomatoes, sauerkraut, fruit juices or pie filling) to remain on the surface as they may leave a dull spot even after cleaning.
- **DO NOT** clean the oven door gasket (See Fig. 1). The woven material of the oven door gasket is essential for a good seal. Care should be taken not to rub, damage or remove the gasket. **DO NOT** use any cleaning materials on the oven door gasket. Doing so could cause damage to the door gasket.

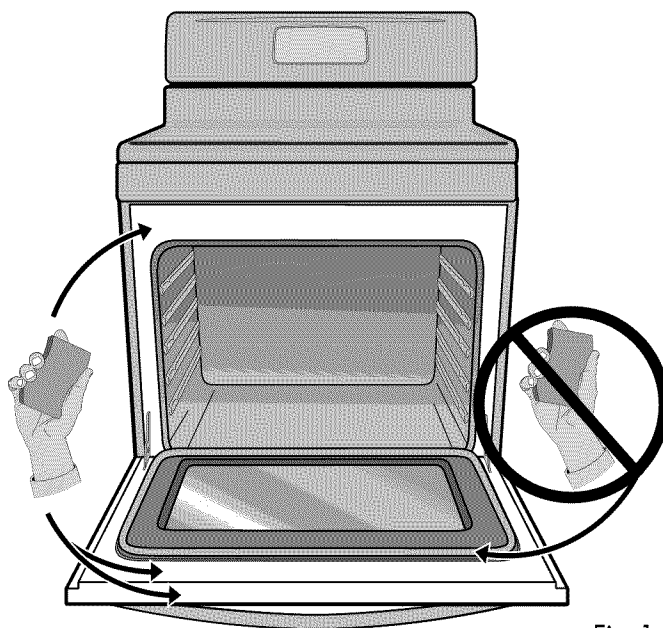

Fig. 1

Setting Flex Clean

Example — To set Flex Clean to start immediately:

1. Be sure to remove **ALL** items from oven except porcelain coated heavy duty oven racks. Remove all items from the cooktop. Be sure oven door is **completely** closed.
2. Press **Flex Clean** keypad for a default 3-hour clean time. After pressing Flex Clean you may accept the default 3-hour clean time by going to step 3.

At this time you may choose a different clean time. The amount of clean time must be within 2 to 4 hours and entered using the numeric keys pads. For example enter **2 0 0** for a 2-hour time or enter **4 0 0** for a 4-hour self-clean time. You may choose a 2 hour 15 minute clean time by entering **2 1 5** (hours and minutes).

3. Press  to activate Flex Clean.

Flex Clean

As soon as Flex Clean becomes active, a motor driven lock mechanism will begin locking the oven door automatically. **door Loc** will appear in the display (See Fig. 1). **DO NOT** open the oven door when **door Loc** is displayed (allow 15 seconds for the lock mechanism to lock the oven door).

Once the oven door has locked, **CLn** will appear in the display indicating Flex Clean has started (Fig. 2).



Fig. 1



Fig. 2



Fig. 3



Fig. 4

When Flex Clean is finished:

1. **CLn** message will turn off and **Hot** will appear in display window (See Fig. 3).
2. Once the oven has cooled down (about 1 hour) and **Hot** is no longer displayed the **door OPn** message will appear (Fig. 4). **When this message turns off the oven door may be opened.**

⚠ CAUTION Use caution when opening the oven door after self-cleaning. The oven may still be **VERY HOT and can cause burns**. To avoid possible burns stand to the side of the oven when opening the oven door to allow hot air or steam to escape.



3. When the oven interior has completely cooled, wipe away any residue or powdered ash with a damp cloth or paper towel.

Important notes:

- The kitchen area should be well ventilated using an open window, ventilation fan or exhaust hood during the 1st self-clean cycle. This will help eliminate the normal odors associated with the 1st self-clean cycle.
- When the clean time finishes the oven door will remain locked until the range has cooled sufficiently. In addition to the clean time that was programmed, you must allow about 1 additional hour for the oven to cool before you will be able to open the oven door.
- The Flex Clean function will not operate whenever a radiant surface element is ON or the oven lockout is active.

Delayed Start Flex Clean

Example — To start a delay Flex Clean with default clean time of 3 hours and a start time of 9:00 o'clock:

1. Be sure the clock is set with the correct time of day, the oven is empty and ALL oven racks are removed. Be sure oven door is completely closed.
2. Press **Delay Start** keypad.
3. Using numeric keypad enter **9 0 0** for time to start.
4. Press  to accept.
5. Press **Flex Clean** keypad.
6. Press .

If it becomes necessary to stop Flex Clean when active:

1. Press .
2. If Flex Clean has heated the oven to a high temperature, allow enough time for the oven to cool and for the **door OPn** message to appear (Fig. 4). When this message turns OFF the oven door may be opened.
3. Restart Flex Clean if needed.

Important notes:

- When Flex Clean function is active you may check the amount of clean time remaining by pressing the Flex Clean keypad once.
- If your control is set with the default 12 hour display mode, the Delay Flex Clean can only be set to start up to 11 hours and 59 minutes in advance. To set a Delay Start Flex Clean to begin 12 or more hours (maximum is 23 hours and 59 minutes) in advance, be sure to set the control for 24 hour display mode.
- If Flex Clean is active and then interrupted by power failure or cancelled before the oven was thoroughly cleaned, it may be necessary to run a self-clean cycle again. If the oven temperature was high enough when interrupted you may need to allow up to 4 hours for the oven to cool before Flex Clean can be started again.

Care & Cleaning

Cleaning recommendation table

Surface type	Recommendation
Painted body parts Painted decorative trim Aluminum, plastic or vinyl trim Control knobs (some models)	For general cleaning, use hot, soapy water and a cloth. For more difficult soils and built-up grease, apply a liquid detergent directly onto the soil. Leave on soil for 30-60 minutes. Rinse with a damp cloth and dry. Do not use abrasive cleaners on any of these materials; they can scratch. To remove control knobs, turn to OFF position; grasp firmly and pull straight off the shaft. To replace knobs after cleaning, line up the flat sides of both knob and shaft; then push knob into place.
Control panel Control keypad membrane Decorative trim (some models)	Before cleaning the control panel, turn all controls OFF, activate oven lockout (on some models) and if needed remove any knobs from panel. Do not use abrasive cleaners on any of these materials; they can scratch. Clean using hot, soapy water and a dishcloth. Be sure to squeeze excess water from dishcloth before wiping control panel; especially when wiping around the controls area. Excess water in or around the controls may cause damage to the appliance. When rinsing, use clean water and a dishcloth and be sure to squeeze excess water from dishcloth before wiping the control panel.
Porcelain enamel parts & door liner	Gentle scrubbing with a soapy no-scratch cleaning pad will remove most spots. Rinse with a 1:1 solution of clear water and ammonia. If necessary, cover difficult spots with an ammonia-soaked paper towel for 30 to 40 minutes. Rinse with clean water and a damp cloth, and then scrub with a soap-filled no-scratch cleaning pad. Rinse and wipe dry with a clean cloth. Do not allow food spills with high sugar or acid content (milk, tomatoes, sauerkraut, fruit juices or pie filling) to remain on the surface; they may cause a dull spot even after cleaning.
Oven interior	For oven interior remove excessive spillovers from oven cavity bottom before starting Flex Clean. Clean any soils from oven frame and door liner outside the oven door gasket. For very important cleaning precautions be sure to read all the instructions in the Flex Clean section.
Porcelain coated oven racks	Porcelain coated heavy duty oven racks may be left in oven during Flex Clean. After a self-cleaning cycle, let the oven completely cool. If needed use a damp cloth to wipe any ash from oven racks.
Oven door	Use soap & water to thoroughly clean the top, sides and front of the oven door. Rinse well. You may use a glass cleaner on the outside glass of the oven door. Do not immerse the door in water. Do not spray or allow water or the glass cleaner to enter the door vents. Do not use oven cleaners, cleaning powders or any harsh abrasive cleaning materials on the outside of the oven door.
Cooktop surface, surface burners and burner grates	Do not use spray oven cleaners on the cooktop. See Cleaning the cooktop and burner grates instructions provided in the Care & Cleaning section.
Stainless Steel (some models)	Only use cleaners and polishes that are specifically manufactured for cleaning stainless steel. Always wipe in direction of metal grain to avoid damaging. Do not use cleaners with high concentrations of chlorides or chlorine. Do not use harsh scrubbing cleaners. Polish with a lint-free cloth. Always be sure to wipe excess cleaner/polish off from the metal surface as bluish stains may occur during future oven heating that cannot be removed. Clean heavier soils with hot, soapy water and a dishcloth. Rinse and dry using clean water and a cloth.

Care & Cleaning

Cleaning the cooktop and surface burners

⚠ CAUTION To avoid possible burns **DO NOT** attempt any of the cooktop cleaning instructions provided before turning OFF all of the surface burners and allow them to completely cool.

⚠ CAUTION Any additions, changes or conversions required in order for this appliance to satisfactorily meet the application needs must be made by an authorized qualified agency.

Routinely clean the cooktop. Wipe with a clean, damp cloth and wipe dry to avoid scratches.

Keeping the surface burner head ports and slots clean will prevent improper ignition and an uneven flame. See the following sections for more instructions.

Cleaning recessed and contoured areas of cooktop

If a spill occurs on or in the recessed or contoured areas, blot up spill with an absorbent cloth. Rinse with a clean, damp cloth and wipe dry.

Cleaning surface burner grates

- Clean only after the grates are completely cool.
- Use nonabrasive plastic scrubbing pad and mild abrasive cleanser or clean in the dishwasher.
- Food soils containing acids may affect the finish. Clean immediately after the grates are cool.
- Thoroughly dry grates **immediately** following cleaning.

Cleaning burner caps

- Remove caps from burner heads after they have cooled.
- Clean heavy soils with a plastic scrubbing pad and absorbent cloth.
- Thoroughly dry burner caps immediately following cleaning including the bottom and inside of cap.
- Do not use abrasive cleaners. They can scratch porcelain.
- Do not clean burner caps in the dishwasher.
- **Do not operate surface burners without burner caps properly in place. Read important notes.**

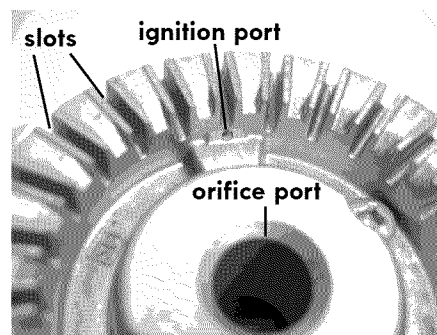

Fig. 1 - cooktop burner head

Cleaning surface burner heads

For proper gas flow it may be necessary to clean the burner head and slots. To clean, first use a clean DAMP cloth to soak up any spills. Remove any food from between the burner slots using a small nonabrasive brush like a toothbrush and afterwards wipe up using a damp cloth. For stubborn soils located in the slots, use a small-gauge wire or needle to clean.

Any spill on or around the electrode must be carefully cleaned. Take care not to hit the electrode with any thing hard or it could be damaged.

To clean the burner head ignition ports

Each burner head has a small ignition port located as shown. Should you experience ignition problems it may be that this port hole is partially blocked with soil. With the burner head in place, use a small wire gauge needle or the end of a paper clip to clear the ignition port (See to Fig. 1; round style shown - oval or Dual Ring burner on some models not shown).

Important notes:

- The surface burner heads are secured to the cooktop and must be cleaned in place on the cooktop.
- **Always** keep the surface burner caps in place **whenever a surface burner is in use.**
- When replacing the burner caps, be sure the burner caps are **seated firmly on top of the burner heads.**
- For proper flow of gas and ignition of burners **DO NOT** allow spills, food, cleaning agents or any other material to enter the gas orifice port opening.

Care & Cleaning

General cleaning

Refer to the **Cleaning recommendation table** in the Care & Cleaning section for more detailed information about cleaning specific parts of the range.

⚠ CAUTION Before manually cleaning any part of the range, be sure all controls are turned OFF and the range is COOL. **The range may be hot** and can cause burns.

⚠ CAUTION Ammonia must be rinsed before operating the oven. Provide adequate ventilation.

Aluminum foil and utensils

⚠ WARNING NEVER cover any slots, holes or passages in the oven bottom or cover an entire oven rack with materials such as aluminum foil. Doing so blocks air flow through the oven and may cause **CARBON MONOXIDE** poisoning. Aluminum foil linings may trap heat, causing a fire hazard.

- **Aluminum foil** - Use of aluminum foil on a hot cooktop can damage the cooktop. Do not use thin aluminum cooking utensils or allow aluminum foil to touch the surface burners under ANY circumstances.
- **Aluminum utensils** - The melting point of aluminum is much lower than that of other metals. Care must be taken when aluminum pots or pans are used on the cooktop. If aluminum pans are allowed to boil dry when using the cooktop, the utensil may be damaged or destroyed.

Replacing oven lights

⚠ CAUTION Be sure the range is unplugged and all parts are COOL before replacing oven light. Wear a leather-faced glove for protection against possible broken glass.

The oven lights are located at the rear of the oven cavity and are covered with a glass shield held by a wire holder. The glass shield protects the light bulb and must be in place whenever the oven is in use.

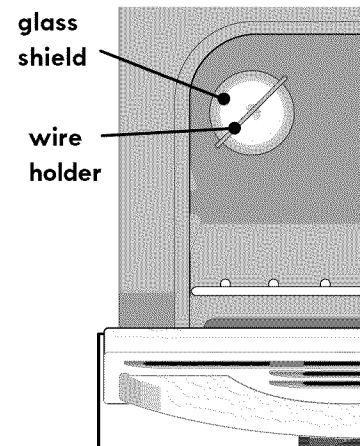

To replace the interior oven light bulb:

1. Turn electrical power off at the main source or unplug the range.
2. Press wire holder to one side to release the glass shield that covers the light bulb.
3. Replace light with a new 40 watt appliance bulb.
4. Replace glass shield over bulb and snap wire holder back into place.
5. Turn power on at the main source (or plug the appliance in).
6. The clock will then need to be reset. To reset, see **Setting clock** in this Use & Care Guide.

Care & Cleaning

Removing and replacing the lift-off oven door

⚠ CAUTION To avoid possible injury when removing or replacing the oven door, follow the instructions below **carefully** and always hold the oven door with both hands positioned **away from the door hinge area**.

⚠ CAUTION The door is heavy. For safe, temporary storage, lay the door flat with the inside of the door facing down.

To remove oven door:

1. Open oven door completely (horizontal with floor - Fig.1).
2. Pull the door hinge locks on both left and right door hinges down from the oven frame completely towards the oven door (Fig. 2). A tool such as a small flat-blade screwdriver may be required.
3. Firmly grasp both sides of oven door along the door sides (Do not use the oven door handle - Fig. 3).
4. Close the door to the broil stop position (the oven door will stop into this position just before fully closing).
5. With the oven door in the broil stop position, lift the oven door hinge arms over the roller pins located on each side of the oven frame (Fig. 4).

To replace oven door:

1. Firmly grasp both sides of oven door along the door sides (Do not use the oven door handle - Fig. 3).
2. Holding the oven door at the same angle as the removal position, seat the hook of the hinge arm over the roller pins located on each side of the oven door frame (Fig. 4). The hook of the hinge arms must be fully seated onto the roller pins.
3. Fully open the oven door (horizontal with floor - Fig. 1).
4. Push the door hinge locks up towards and into the oven frame on both left and right oven door hinges (Fig. 2) to the locked position; then close the oven door.

Special door care instructions

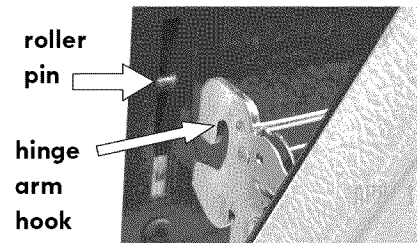
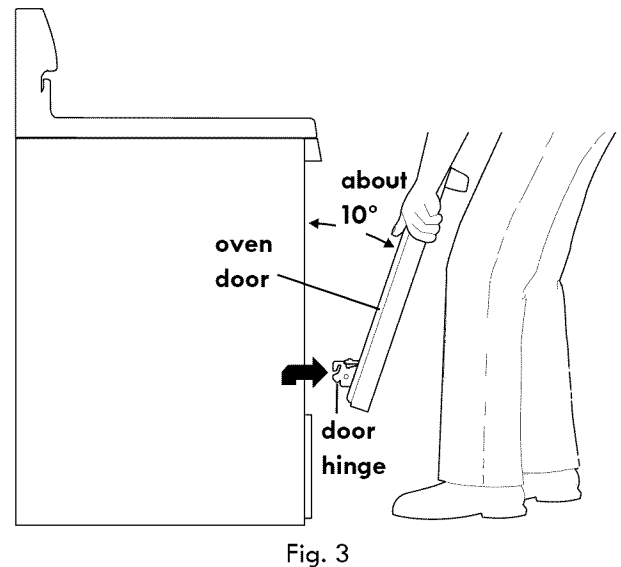
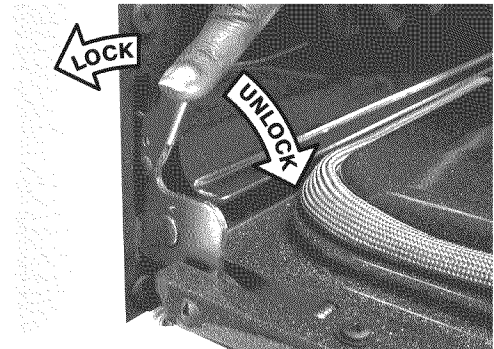
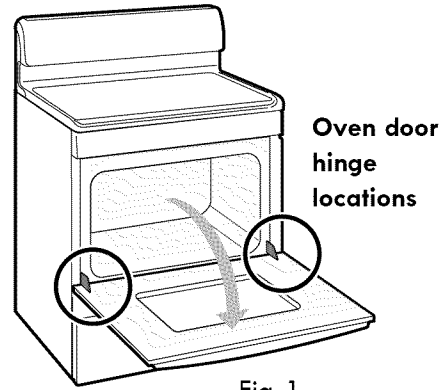

Most oven doors contain glass that can break. Read the following recommendations:

- Do not close the oven door until all the oven racks are fully in place inside the oven cavity.
- Do not hit the glass with pots, pans, or any other object.
- Scratching, hitting, jarring or stressing the glass may weaken its structure causing an increased risk of breakage at a later time.



Before You Call • Solutions to common problems

Before you call for service, review the following list. It may save you time & expense. Possible solutions to these problems are provided with the problem listed:

Problem	Solution
Poor baking results.	<ul style="list-style-type: none">• Many factors affect baking results. Make sure the proper oven rack position is used. Center food in the oven and space pans to allow air to circulate. Allow the oven to preheat to the set temperature before placing food in the oven. Try adjusting the recipe's recommended temperature or baking time. If you feel the oven is too hot or cool, see Adjusting oven temperature in Setting Oven Controls section.
Appliance is not level.	<ul style="list-style-type: none">• Be sure floor is level, strong & stable enough to adequately support range.• If floor is sagging or sloping, contact a carpenter to correct the situation.• Poor installation. Place oven rack in center of oven. Place a level on the oven rack. Adjust leveling legs at base of appliance until the rack is level.• Kitchen cabinet alignment may make range appear not level. Be sure cabinets are square & have sufficient room for appliance clearance.
Cannot move appliance easily. Appliance must be accessible for service.	<ul style="list-style-type: none">• Cabinets not square or are built in too tightly. Contact builder or installer to make appliance accessible.• Carpet interferes with appliance. Provide sufficient space so appliance can be lifted over carpet.• Gas line is hard-plumbed. Have a flexible CSA International approved metal appliance connector installed.
Oven portion of appliance does not operate.	<ul style="list-style-type: none">• Be sure regulator gas valve is turned to ON. See installation instructions.• The time of day is not set. The time of day must first be set in order to operate the oven. See Setting clock in Setting Oven Controls section.• Be sure the oven controls are set properly for the desired function. See Setting Oven Controls section and review instructions for the desired cooking function in this manual or see "Entire appliance does not operate" in this checklist.
Entire appliance does not operate.	<ul style="list-style-type: none">• Make sure power cord is plugged properly into outlet.• Electrical power outage. Check house lights to be sure. Call your local electric company for service outage information.• Service wiring is not complete. Call 1-800-4-MY-HOME® for assistance (See back cover).
Oven control beeps and displays F code error.	<ul style="list-style-type: none">• Oven control has detected a fault or error condition. Press  key pad to clear the error code. Try Bake or Broil function. If the F code error repeats, remove power from appliance, wait 5 minutes and then repower appliance and set clock with the correct time of day. Try Bake or Broil function again. If the fault recurs, press  to clear and call 1-800-4-MY-HOME® for assistance (See back cover).

Before You Call • Solutions to common problems

Problem	Solution
Oven smokes excessively when broiling.	<ul style="list-style-type: none">• Incorrect setting. Follow broiling instructions in Setting Oven Controls section.• Be sure oven door is closed when broiling.• Meat too close to upper burner. Reposition the oven rack to provide proper clearance between the meat & the upper burner. Preheat oven when searing.• Meat not properly prepared. Remove excess fat from meat. Cut remaining fatty edges to prevent curling, but do not cut into lean.• Grease has built up on oven surfaces. Regular cleaning is necessary when broiling frequently. Old grease or food spatters cause excessive smoking.
Flames inside oven or smoking from oven vent.	<ul style="list-style-type: none">• Excessive spillovers in oven. For example this will happen for pie spillovers or large amounts of grease left on the oven bottom. Wipe up excessive spillovers before starting oven. If flames or excessive smoke are present see Broil in Setting Oven Controls section.
Convection fan does not rotate.	<ul style="list-style-type: none">• Allow 6 minutes for convection fan to start rotating after setting Convection.• Oven door is open. Convection fan will turn off if oven door is opened when Convection is active. Close oven door.
Flex Clean does not work.	<ul style="list-style-type: none">• Oven control not set properly. Review instructions in Flex Clean section.
Soil not completely removed after Flex Clean.	<ul style="list-style-type: none">• Flex Clean was interrupted. Review instructions in Flex Clean section.• Excessive spillovers on oven bottom. Remove before starting Flex Clean.• Failure to clean soil from the oven frame, the door liner outside the oven door gasket and the small area at the front center of the oven bottom. These areas are not in the self-cleaning area, but get hot enough to burn on residue. Clean these areas before the self-cleaning cycle is started. Burned-on residue can be cleaned with a stiff nylon brush and water or a nylon scrubber. Be careful not to damage the oven gasket.
Oven light does not work.	<ul style="list-style-type: none">• Be sure the oven light is secure in the socket. Also see Replacing oven light in the Care & Cleaning section.

Before You Call • Solutions to common problems

Problem	Solution
Surface burners do not ignite.	<ul style="list-style-type: none">• Surface control knob was not completely turned to LITE. Push in & turn the surface control knob to LITE until burner ignites and then turn control knob to desired flame size.• Burner ports are clogged. With the burner OFF, use a small-gauge wire or needle to burner head slots and ignition ports. See Cleaning the cooktop and surface burners in the Care & Cleaning section for additional cleaning instructions.• Range power cord is disconnected from outlet (electric ignition models only). Be sure power cord is securely plugged into the power outlet.• Electrical power outage. Burners may be lit manually. See section on Setting Surface Controls.
Surface burner flame uneven or only part way around burner cap.	<ul style="list-style-type: none">• Burner slots or ports are clogged. With the surface burner OFF, clean ports with a small-gauge wire or needle.• Moisture is present after cleaning. Lightly fan the flame and allow burner to operate until flame is full.• Burner caps are not seated properly. Check that all burner caps are level and seated correctly on burner heads. See Cleaning the cooktop and surface burners in the Care & Cleaning section.
Surface burner flame is too high.	<ul style="list-style-type: none">• Surface control knob is set too high. Adjust to lower flame setting.• Burner caps are not seated properly. Check that all surface burner caps are level and seated correctly on surface burner heads. See Cleaning the cooktop and surface burners in the Care & Cleaning section.• Incorrect L.P. conversion. Refer to L.P. conversion kit instructions to correct.
Surface burner flame is orange.	<ul style="list-style-type: none">• Dust particles in main gas line. Allow the burner to operate a few minutes until flame turns blue. In coastal areas, a slightly orange flame is unavoidable due to salt content in air.

Protection Agreements

Master Protection Agreements

Congratulations on making a smart purchase. Your new Kenmore® product is designed and manufactured for years of dependable operation. But like all products, it may require preventive maintenance or repair from time to time. That's when having a Master Protection Agreement can save you money and aggravation.

The Master Protection Agreement also helps extend the life of your new product. Here's what the Agreement* includes:

- ☑ **Parts and labor** needed to help keep products operating properly **under normal use**, not just defects. Our coverage goes **well beyond the product warranty**. No deductibles, no functional failure excluded from coverage – **real protection**.
- ☑ **Expert service** by a force of more than **10,000 authorized Sears service technicians**, which means someone you can trust will be working on your product.
- ☑ **Unlimited service calls and nationwide service**, as often as you want us, whenever you want us.
- ☑ **"No-lemon" guarantee** – replacement of your covered product if four or more product failures occur within twelve months.
- ☑ **Product replacement** if your covered product can't be fixed.
- ☑ **Annual Preventive Maintenance Check** at your request – no extra charge.
- ☑ **Fast help by phone** – we call it **Rapid Resolution** – phone support from a Sears representative on all products. Think of us as a "talking owner's manual".
- ☑ **Power surge protection** against electrical damage due to power fluctuations.
- ☑ **\$250 Food Loss Protection** annually for any food spoilage that is the result of mechanical failure of any covered refrigerator or freezer.
- ☑ **Rental reimbursement** if repair of your covered product takes longer than promised.
- ☑ **10% discount** off the regular price of any non-covered repair service and related installed parts.

Once you purchase the Agreement, a simple phone call is all that it takes for you to schedule service. You can call anytime day or night, or schedule a service appointment online.

The Master Protection Agreement is a risk free purchase. If you cancel for any reason during the product warranty period, we will provide a full refund. Or, a prorated refund anytime after the product warranty period expires. Purchase your Master Protection Agreement today!

Some limitations and exclusions apply. For prices and additional information in the U.S.A. call 1-800-827-6655.

*** Coverage in Canada varies on some items. For full details call Sears Canada at 1-800-361-6665.**

Sears Installation Service

For Sears professional installation of home appliances, garage door openers, water heaters, and other major home items, in the U.S.A. or Canada call 1-800-4-MY-HOME®.

Acuerdos de protección

Acuerdos maestros de protección

Enhorabuena por haber hecho una compra inteligente. Su nuevo producto Kenmore® está diseñado y fabricado para brindarle años de funcionamiento fiable. Pero, como cualquier producto, puede necesitar mantenimiento preventivo o reparaciones periódicas. Es por eso que tener un Acuerdo maestro de protección podría ahorrarle dinero y molestias.

El Acuerdo maestro de protección también sirve para prolongar la durabilidad de su nuevo producto. El acuerdo* incluye lo siguiente:

- ☑ **Piezas y mano de obra** necesarias para contribuir a mantener el funcionamiento adecuado de los productos **utilizados en condiciones normales de uso**, no sólo en caso de defectos de los productos. Nuestra cobertura va **mucho más allá que la garantía del producto**. No se aplican deducibles ni exclusiones por fallas del funcionamiento: es decir, **verdadera protección**.
- ☑ **Servicio técnico por expertos** (más de **10000 técnicos autorizados de Sears**), lo cual significa que quien repare o realice el mantenimiento de su producto será un profesional de confianza.
- ☑ **Servicio técnico a escala nacional y número ilimitado de llamadas de solicitud de servicio técnico**: se puede poner en contacto con nosotros cuantas veces lo desee y cuando lo desee.
- ☑ **Garantía "sin sorpresas"**: se reemplaza el producto cubierto por el acuerdo si ocurren cuatro o más fallas del producto en un periodo de 12 meses.
- ☑ **Reemplazo del producto**: en caso de que no se pueda reparar el producto cubierto por el acuerdo.
- ☑ **Revisión anual preventiva de mantenimiento del producto**: puede solicitarla en cualquier momento, sin costo alguno.
- ☑ **Rápida asistencia telefónica**, la cual denominamos **Solución rápida**: es decir, asistencia telefónica a través de cualquiera de nuestros representantes de Sears, sobre cualquiera de nuestros productos. Piense en nosotros como en un "manual parlante del usuario".
- ☑ **Protección contra fallas eléctricas**, contra daños debidos a fluctuaciones de la corriente eléctrica.
- ☑ **\$250 al año para cubrir cualquier posible deterioro de alimentos** que haya tenido que desechar debido a una falla mecánica de cualquiera de nuestros refrigeradores o congeladores cubiertos por este acuerdo.
- ☑ **Devolución de gastos de alquiler de electrodomésticos** si la reparación de su producto asegurado toma más que el tiempo prometido.
- ☑ **10% de descuento** aplicable tanto a los costos del servicio de reparación, como de las piezas instaladas relacionadas que no hayan quedado cubiertos por este acuerdo.

Una vez que haya realizado el pago de este acuerdo, bastará una simple llamada telefónica para concertar una visita de servicio. Puede llamar a cualquier hora del día o de la noche, o bien concertar una visita de servicio por Internet.

La adquisición del Acuerdo maestro de protección es una inversión exenta de riesgos. Si por cualquier motivo decide cancelar dicho acuerdo durante el periodo de garantía del producto, le haremos un reintegro total del valor. O bien un importe proporcional si cancela el acuerdo en cualquier otro momento posterior al vencimiento del periodo de garantía del producto. ¡Adquiera hoy mismo su Acuerdo maestro de protección!

Algunas limitaciones y exclusiones podrían aplicarse. Para solicitar precios e información adicional, llame al 1-800-827-6655 (en los EE.UU.).

*** La cobertura en Canadá varía en el caso de algunos artículos. Para obtener detalles completos al respecto, llame al 1-800-361-6665 de Sears de Canadá.**

Servicio de instalación de Sears

Para solicitar la instalación por profesionales de Sears de electrodomésticos, abridores de puertas de garage, calentadores de agua y otros artículos de uso prioritario en el hogar, llame al 1-800-4-MY-HOME en los EE.UU. o Canadá.

Get it fixed, at your home or ours!

Your Home

For troubleshooting, product manuals and expert advice:



www.managemylife.com

For repair – **in your home** – of **all** major brand appliances, lawn and garden equipment, or heating and cooling systems, **no matter who made it, no matter who sold it!**

For the replacement parts, accessories and owner's manuals that you need to do-it-yourself.

For Sears professional installation of home appliances and items like garage door openers and water heaters.

1-800-4-MY-HOME[®] (1-800-469-4663)

Call anytime, day or night (U.S.A. and Canada)

www.sears.com www.sears.ca

Our Home

For repair of carry-in items like vacuums, lawn equipment, and electronics, call anytime for the location of your nearest

Sears Parts & Repair Service Center

1-800-488-1222 (U.S.A.)

www.sears.com

1-800-469-4663 (Canada)

www.sears.ca

To purchase a protection agreement on a product serviced by Sears:

1-800-827-6655 (U.S.A.)

1-800-361-6665 (Canada)

Para pedir servicio de reparación a domicilio, y para ordenar piezas:

1-888-SU-HOGAR[®]

(1-888-784-6427)

www.sears.com

Au Canada pour service en français:

1-800-LE-FOYER^{MC}

(1-800-533-6937)

www.sears.ca

The Sears logo, featuring the word "Sears" in a large, stylized, serif font with a shadow effect.

® Registered Trademark / TM Trademark of KCD IP, LLC in the United States, or Sears Brands, LLC in other countries

® Marca Registrada / TM Marca de Fábrica de KCD IP, LLC en Estados Unidos, o Sears Brands, LLC in otros países

^{MC} Marque de commerce / ^{MD} Marque déposée de Sears Brands, LLC