

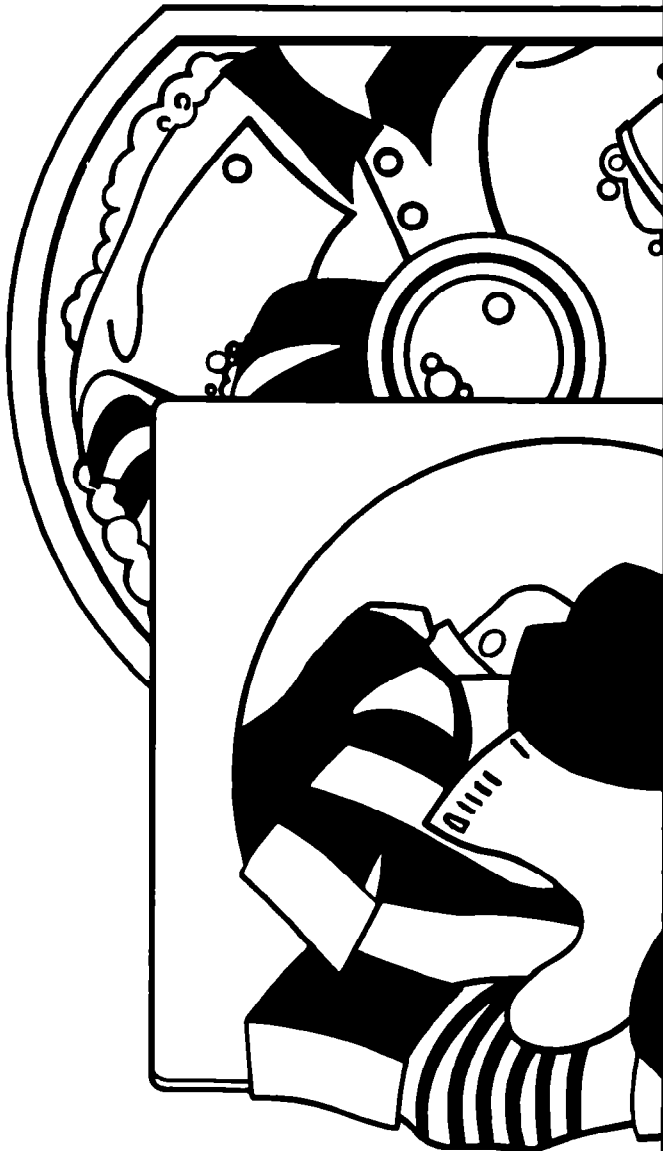

Use And Care

G U I D E



A Note To You	2
Understanding Safety	3
Getting To Know Your Washer/Dryer	6
Operating Your Washer	7
Other Washer/Dryer Features	12
Operating Your Dryer	14
Caring For Your Washer/Dryer	19
Laundry Tips	23
If You Need Assistance Or Service	37
Warranty	40

1-800-253-1301

Call us with questions or comments.

**LARGE CAPACITY
THIN TWIN® AUTOMATIC WASHER/DRYER**

A NOTE TO YOU

A Note To You

Thank you for buying a Whirlpool® appliance.

You have purchased a quality, *world-class* home appliance. Years of engineering experience have gone into its manufacturing. To ensure many years of trouble-free operation, we have developed this Use and Care Guide. It is full of valuable information on how to operate and maintain your appliance properly and safely. Please read it carefully. Also, please complete and mail the Ownership Registration Card provided with your appliance. This will help us notify you about any new information on your appliance.

Your safety is important to us.

This guide contains safety symbols and statements. Please pay special attention to these symbols and follow any instructions given. Here is a brief explanation of the use of each symbol.

WARNING

This symbol will help alert you to such dangers as personal injury, burns, fire and electrical shock.

CAUTION

This symbol will help you avoid actions which could cause product damage (scratches, dents, etc.) and damage to your personal property.

Our Consumer Assistance Center number, 1-800-253-1301, is toll-free 24 hours a day.

If you have a question concerning your appliance's operation, or if you need service, first see "If You Need Assistance Or Service" on page 37. If you need further help, call us. When calling, you will need to know your appliance's complete model number and serial number. You can find this information on the model and serial number label (see diagram on page 6). For your convenience, we have included a handy place below for you to record these numbers, the purchase date from the sales slip and your dealer's name and telephone number. Keep this book and the sales slip together in a safe place for future reference.

Model Number _____

Dealer Name _____

Serial Number _____

Dealer Phone _____

Purchase Date _____

Understanding Safety

⚠ WARNING

For your safety, the information in this manual must be followed to minimize the risk of fire or explosion or to prevent property damage, personal injury or loss of life.

–Do not store or use gasoline or other flammable vapors and liquids in the vicinity of this or any other appliance.

–WHAT TO DO IF YOU SMELL GAS:

- **Do not try to light any appliance.**
- **Do not touch any electrical switch; do not use any phone in your building.**
- **Clear the room, building or area of all occupants.**
- **Immediately call your gas supplier from a neighbor's phone. Follow the gas supplier's instructions.**
- **If you cannot reach your gas supplier, call the fire department.**

Installation and service must be performed by a qualified installer, service agency or the gas supplier.

IMPORTANT SAFETY INSTRUCTIONS

WARNING

To reduce the risk of fire, electrical shock or injury to persons when using your washer/dryer, follow basic precautions, including the following:

- Read all instructions before using your THIN TWIN® washer/dryer.
 - Do not machine wash or machine dry items cleaned, washed, soaked in, or spotted with wax, paint, gasoline, oil, dry cleaning solvents, or other flammable fluids. The fumes can create a fire hazard or explosion. Always hand wash and line dry items containing these materials.
 - Flammable fluids (dry-cleaning solvents, kerosene, gasoline, etc.) should not be used or stored in or near your washer/dryer. Do not add flammable fluids to your wash water. These substances give off vapors that can create a fire hazard or explosion.
 - Do not allow children to operate, play with, or crawl on or inside your washer/dryer. Supervise children closely when your washer/dryer is used near them.
 - Before your washer/dryer is removed from service or discarded, remove the lid and door to prevent accidental entrapment.
 - After starting a cycle, do not reach into the basket unless the washer Cycle Control Knob is pushed in and all motion stops.
 - Do not reach into your dryer if the drum is moving.
 - Do not dry rubber, rubber-like, or heat-sensitive materials with heat.
 - Do not tamper with the controls.
 - If your hot water has not been used recently (usually 2 weeks or longer), hydrogen gases may build up in your water heater and your hot water pipes. **HYDROGEN GAS IS EXPLOSIVE.** To prevent injury or damage, before using your washer/dryer, turn on all hot water faucets and allow water to run for several minutes. This will allow gases to escape. Do not smoke or use any open flame near your faucet while it is open.
- Please ...
- Install and level washer/dryer in a well-ventilated room and on a floor that can support the weight.*
 - Connect washer/dryer to the correct 3-prong outlet, electrical supply, water supply, and drain.*
 - Ground washer/dryer properly.*
 - Have only a qualified person install, repair, or replace parts on washer/dryer.
 - Protect washer/dryer from the weather and keep it where the temperature is above 45°F (7°C).
 - Maintain washer/dryer properly.
 - Use only fabric softeners specifically labeled as not being harmful to the dryer.
 - Do not allow lint to build up inside the dryer or exhaust system. Cleaning should be done periodically by a qualified person.
 - Clean lint screen before or after each load.
 - Do not let dust, lint, paper, rags, chemicals, etc. pile up around or under your washer/dryer.
- *See the Installation Instructions.

– SAVE THESE INSTRUCTIONS –

Understanding your responsibilities

- Unplug the power supply cord or turn off electrical power before attempting to service your washer/dryer. Shut off gas valve if you have a gas washer/dryer.
- Do not wash or dry items that are soiled with vegetable or cooking oil. These items may contain some oil after laundering. Due to the remaining oil, the fabric may smoke or catch fire by itself.
- Store flammable solvents or fluids away from your washer/dryer.
- Dry cleaning solvents or fluids should never be put directly into your washer/dryer.
- Store detergent, laundry aids and other materials in a cool, dry place where children cannot reach them (in a locked cabinet if possible).
- Read and follow instructions on packages of detergent and laundry aids, especially warnings and precautions.
- Do not use chlorine bleach and ammonia or acids (such as vinegar or rust remover) in the same wash. Hazardous fumes can form.
- Unplug power supply cord before attempting to service your washer/dryer.
- Do not machine wash or dry fiberglass materials. Small particles can stick to the fabrics in following loads and cause skin irritation.
- Never operate your washer/dryer if:
 - it is not working right (i.e. noisy, too hot).
 - it is damaged.
 - parts are missing.
 - all panels are not in place.
 - the lint screen is loose, damaged, or missing.
- Be sure that your washer/dryer:
 - is properly connected to fuel and exhaust systems (gas dryers must be vented outdoors).*
 - is not installed against draperies or curtains, or on carpet.*
 - is used only for jobs normally expected of a home washer/dryer.
 - is not used by anyone unable to operate it properly.

*See the Installation Instructions.

– SAVE THESE INSTRUCTIONS –

GETTING TO KNOW YOUR WASHER/DRYER

Getting To Know Your Washer/Dryer

The parts and features of your THIN TWIN® washer/dryer are illustrated in this section. Become familiar with all parts and features before using your washer/dryer.

NOTE: The drawings in this book may vary from your model. They are designed to show the different features of all models covered by this book. Your model may not include all features.

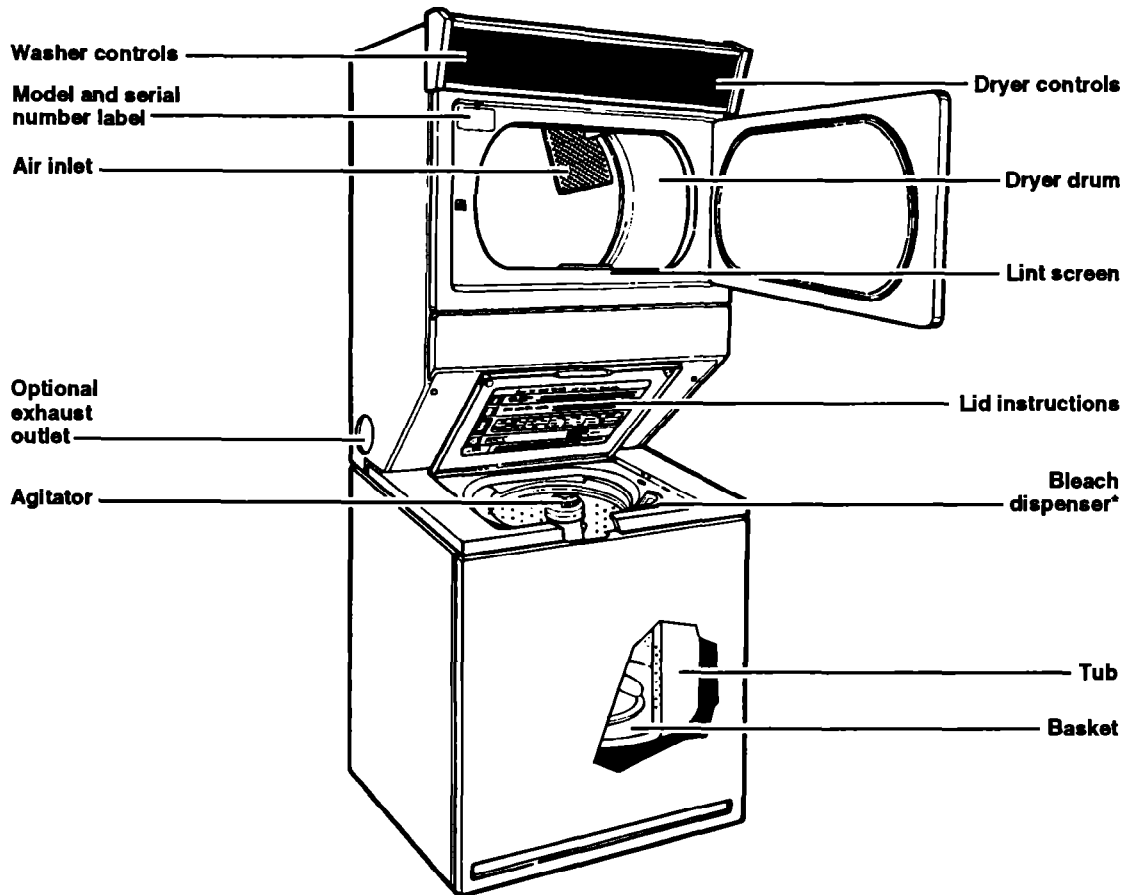

Other features not shown:

Automatic dryness control

End of cycle signal*

MAGIC CLEAN® lint filter*

Manual clean lint filter (inside agitator)*

*Available on some models

Operating Your Washer

In This Section		Page	Page
Before starting your washer	7	Selecting a cycle and time	8
Starting or stopping your washer	7	Using rinse and spin	10
Selecting a load size	7	Using drain and spin	10
Selecting wash-rinse temperatures	8	What happens in each cycle	11

Operating your washer properly ensures maximum washing efficiency. This section gives you important information to help you to select a cycle, time, and temperature for your wash load.

Before starting your washer

Add measured detergent. Then place a sorted load in the washer before starting. See page 23 for additional "Before you wash or dry" information.

NOTE: If your washer/dryer has a Consumer Features Guide, remove it and place it in your Use and Care Guide.

Starting or stopping your washer

Starting your washer:

1. Select load size and water temperatures.
2. Push in the Cycle Control Knob and turn it clockwise. Stop when the indicator on the knob's outer ring points to the number in the wash cycle you want. The numbers are minutes of wash time.
3. Pull out the Cycle Control Knob.

Refer to pages 8-11 for additional information to help you make selections.

Stopping and restarting your washer:

- To stop the washer at any time, push in the Cycle Control Knob.
- To restart the washer, close the lid (if necessary) and pull out the Cycle Control Knob.

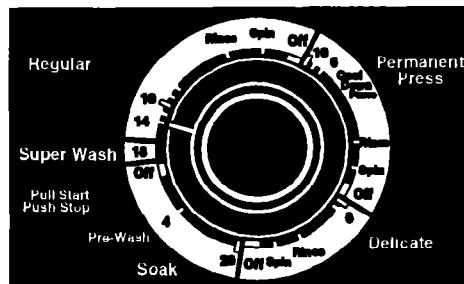

Cycles may vary with model

Selecting a load size

Position the Load Size Selector at the setting that corresponds to the size load you want to wash. Select a load size based upon the size of the load and the fabric you are washing. See page 24 for additional loading information.

To change the load size setting after the washer has started to fill, move the Selector to the desired new setting.

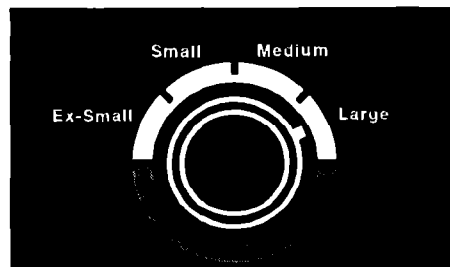

Settings may vary with model

OPERATING YOUR WASHER

Load size tips

- Items should move freely in the washer. Do not overload the machine or select a load size that is too small for the wash load.
- Use a large load size setting for best results with permanent press clothes.
- Reduce wash time when using a small load size setting. Loads with only a few small items need less wash time.

Selecting wash-rinse temperatures

Match the water temperature to the type of fabric and soils being washed. The top temperature is the wash water and the bottom temperature is the rinse water.

Water temperature tips

- Use warm wash water with the Permanent Press and Delicate cycles.
- Always use cold rinse water for permanent press fabrics.
- For heavily soiled permanent press or knit clothes, prewash or presoak before washing in warm water.

See the "Water usage guide" on page 28 for more information.

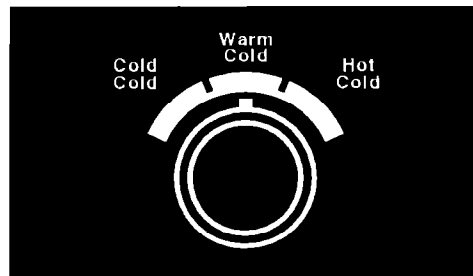

Settings may vary with model

Selecting a cycle and time

You will find information you need to help you make correct cycle selections in this section.

- Pages 9-10: Use the information on these pages to guide you when selecting a wash cycle and time.
- Page 11: Use this page to help you understand what happens during a wash cycle.

NOTE: Your model may not look exactly like the illustrations.

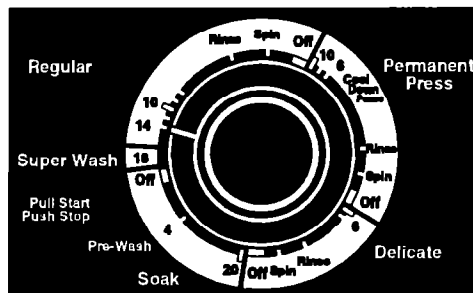

Cycles may vary with model

OPERATING YOUR WASHER

Regular cycle

The Regular cycle features the Gentle Wash system and high spin speeds to shorten drying time.

- Use 14 minutes of wash time to clean sturdily-constructed cotton and linen fabrics that are heavily soiled loads.
- Use 10 minutes of wash time to clean cotton and linen fabrics that are lightly to moderately soiled.

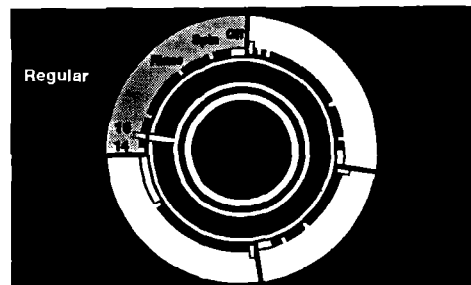

Regular cycle

Permanent Press cycle

The Permanent Press cycle features the Gentle Wash system, a cool-down rinse, and low spin speeds to reduce wrinkling.

- Use 10 minutes of wash time to clean permanent press and some synthetic fabrics that are moderately soiled.
- Use 6 minutes of wash time to clean permanent press and some synthetics that are lightly soiled.

NOTE: The washer pauses briefly during the wash cycle. This is normal for washer operation.

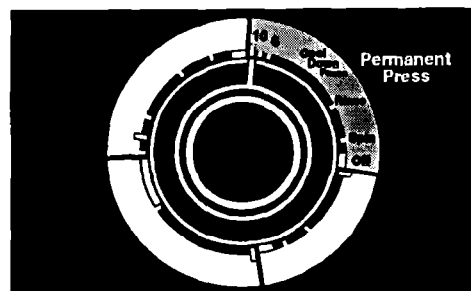

Permanent press cycle

Delicate cycle

The Delicate cycle features a reduced agitation speed for gentle soil removal. Low spin speeds reduce wrinkling.

- Use 8 minutes of wash time to clean delicate items and washable knits that are lightly to moderately soiled.

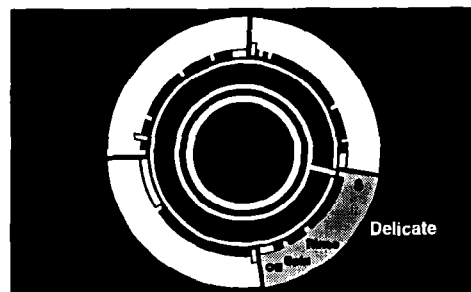

Delicate cycle

Soak cycle

(on some models)

The Soak cycle features brief periods of agitation and soak time to help remove heavy soils and stains that need pretreatment.

- Use warm water when soaking laundry. (Hot water can set stains.) See pages 25-27 for stain removal information.
- Use the amount of detergent or presoak additive recommended by manufacturer.
- After the Soak cycle ends, add detergent and set a new wash cycle.

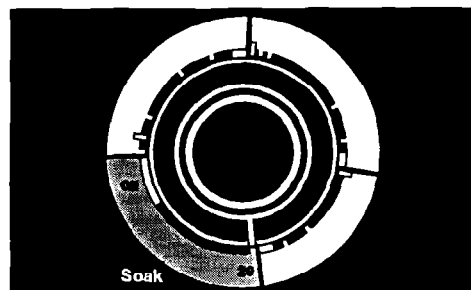

Soak cycle

OPERATING YOUR WASHER

Pre-Wash cycle

(on some models)

The Pre-Wash cycle features a brief period of high speed agitation to help remove heavy soils and stains that need pretreatment.

- Use warm water for prewashing stained laundry. (Hot water can set stains.) See pages 25-27 for stain removal information.
- After the Pre-Wash cycle ends, add detergent and set a new wash cycle.

Super Wash cycle

(on some models)

Super Wash automatically prewashes the laundry and advances into the Regular wash cycle. (The washer does not need to be reset after the Super Wash cycle.) Use this cycle when washing heavily soiled loads that need maximum soil removal.

- For proper cleaning, use double the amount of detergent recommended for a wash cycle.

NOTE: The machine pauses during Super Wash. This is normal for washer operation.

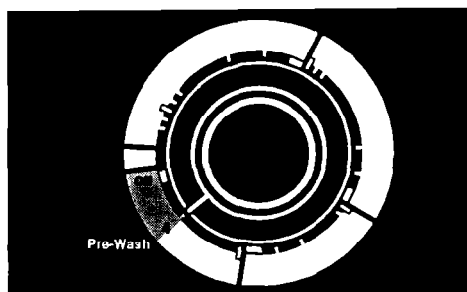

Pre-wash cycle

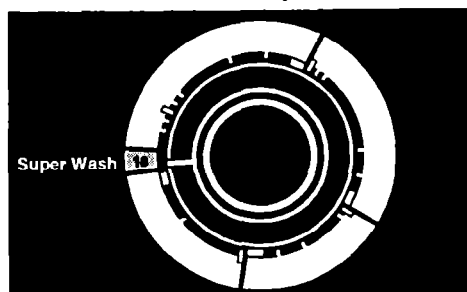

Super wash cycle

Using rinse and spin

When using extra detergent for heavily soiled clothes, or washing special-care items, you may want an extra rinse and spin.

1. Push Cycle Control Knob in and turn clockwise to RINSE, as illustrated.
2. Pull Cycle Control Knob out. The washer will fill to selected load size, agitate, drain, and spin.

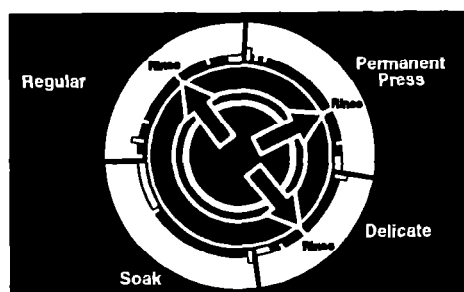

Using drain and spin

A drain and spin may help shorten drying times for some heavy fabrics or special-care items by removing excess water.

1. Push Cycle Control Knob in and turn clockwise to SPIN, as illustrated.
2. Pull Cycle Control Knob out. The washer will drain, and then spin.

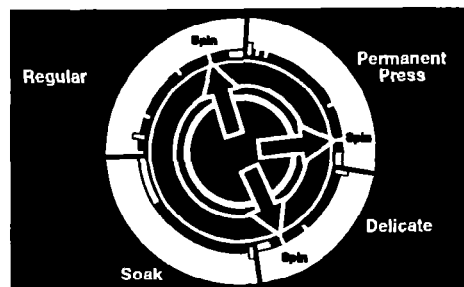

OPERATING YOUR WASHER

What happens in each cycle

When the Cycle Control Knob is set to a number and pulled out, the washer fills (to the selected load size) before agitation and timing start. The washer will begin agitating immediately after filling; agitation can occur with the washer lid up or down. After agitation starts, the Cycle Control Knob turns clockwise until it points to OFF and the cycle ends.

The washer pauses briefly throughout each cycle. These pauses are normal for washer operation.

NOTE: A Gentle Wash system helps protect your fabrics by reducing wash agitation speed during the last few minutes of wash agitation in the Regular and Permanent Press cycles.

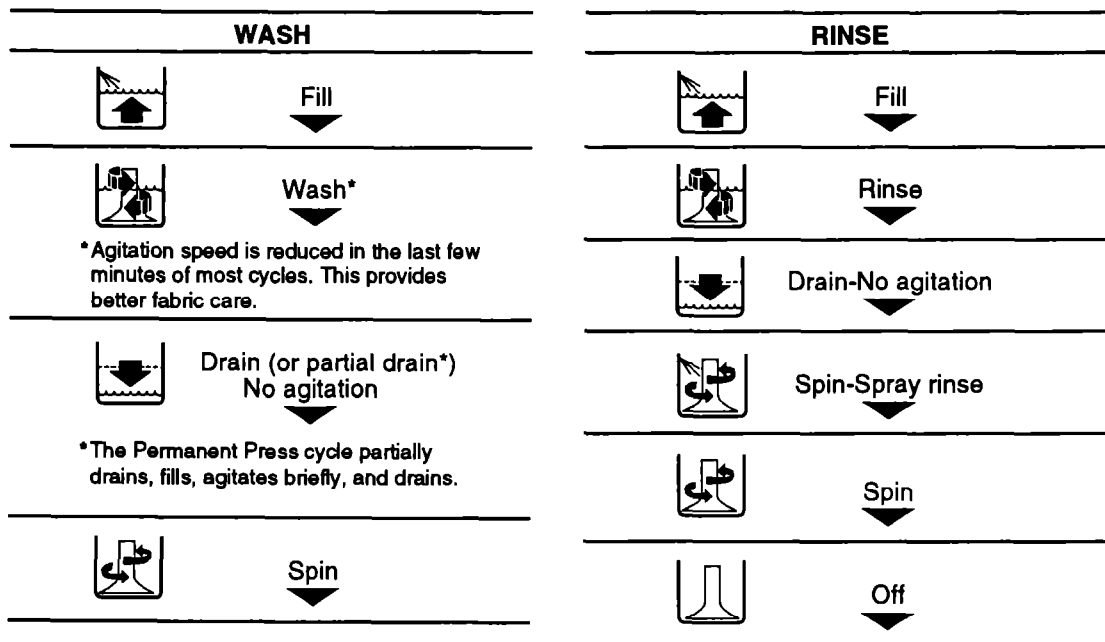



Other Washer/Dryer Features

In This Section		Page	Page
About your lint filter	12	Using the chlorine bleach dispenser	13
End of cycle signal	12	Ordering a fabric softener dispenser	13

Your washer may have the following features. Understanding the use of the features on your machine will help you efficiently use your washer.

About your lint filter

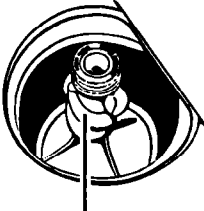
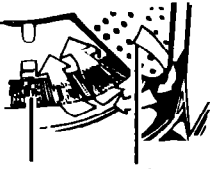
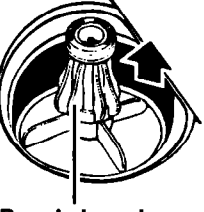
Your washer has either a self-cleaning lint filter (requires no cleaning by you) or a manual clean lint filter. Check the shape of your agitator to see if you need to clean your lint filter.

AGITATOR	ABOUT YOUR FILTER	FILTER
 <p>Spiral-shaped agitator</p>	<p>MAGIC CLEAN® lint filter</p> <p>This lint filter requires no cleaning. (The lint filter at the bottom of the washer basket cleans itself.) During agitation, wash and rinse water pass over the filter, separating the lint from the water. The lint is then spun away from the filter and out of the system during the spin part of the cycle.</p> <p>If your washer drains into a tub, remove any lint collected in the tub or strainer.</p>	 <p>MAGIC CLEAN lint filter Basket interior</p>
 <p>Barrel-shaped agitator</p>	<p>Manual clean lint filter</p> <p>If your agitator is barrel shaped, as illustrated, your machine has a manual clean lint filter. Clean the filter at the bottom of the agitator after every load for the best filtering results.</p> <p>To clean:</p> <ol style="list-style-type: none"> 1. Lift off the agitator barrel. 2. Wash or wipe the filter clean in the bottom of the agitator barrel. The filter is not removable. 3. Replace agitator barrel. Snap it into place. 	 <p>Manual clean lint filter</p>

End of cycle signal

(on some models)

The dryer sounds a signal to let you know when the cycle is finished. The signal is not adjustable and cannot be turned off.

The signal is helpful when you are drying permanent press, synthetics, and other items that should be taken out as soon as the dryer stops.

Using the chlorine bleach dispenser

(on some models)

Always measure liquid chlorine bleach. Do not guess. Never use more than 1 cup (250 mL) for a full load. Use less with lower water level settings. Follow manufacturer's directions for safe use. Use a cup with a pouring spout to avoid spilling.

1. Load the washer.
2. Pour measured chlorine bleach carefully into dispenser. Do not let bleach splash, drip or run down into washer basket. Undiluted bleach will damage any fabric it touches.
3. Start the washer. Bleach will be diluted automatically during wash part of cycle.

NOTE: Do not use this dispenser to add powdered chlorine or all-fabric bleach to your wash load. The dispenser is for chlorine bleach use only.

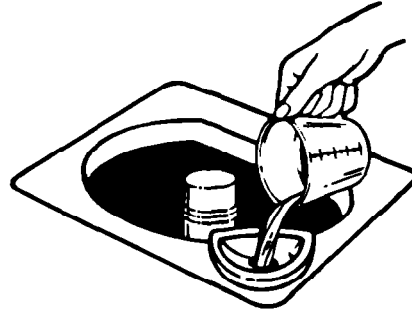

Ordering a fabric softener dispenser

A fabric softener dispenser is available for your washer. Order Fabric Softener Dispenser, Part No. 3350834.

To order write to:

Whirlpool Corporation
Attention: Customer Service Dept.
1900 Whirlpool Drive
LaPorte, IN 46350

Operating Your Dryer

In This Section		Page	Page
Before starting your dryer	14	Understanding your cycles	15
Starting your dryer	14	Selecting the right cycle and setting (models without a temperature selector)	17
Stopping your dryer	14	Selecting the right cycle and setting (models with a temperature selector)	18
Restarting your dryer	14		

The information in this section helps you learn to use your dryer efficiently and safely. Refer to "Laundry Tips" on page 23 for additional control setting, sorting, and loading information.

Before starting your dryer

Wipe the dryer drum with a damp cloth before using to remove dust from storing and shipping.

If your dryer has a Consumer Features Guide, remove it and place it with your Use and Care Guide.

Starting your dryer

1. Load clothes into the dryer and close the door.
2. Turn the Cycle Control Knob either way to the desired setting. (If your dryer has a Temperature Selector, set the selector to the desired setting.)
3. Push the Start Button.

NOTE: Your dryer stops automatically when a cycle ends.

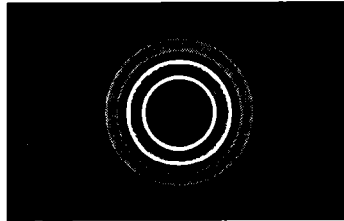

Push to start

Stopping your dryer

You can stop your dryer any time during a cycle. Open the dryer door or turn the Cycle Control Knob to OFF.

NOTE: The Cycle Control Knob should point to an OFF area when the dryer is not in use. If you want to stop the dryer before the cycle is finished, turn the Cycle Control Knob to an OFF area.

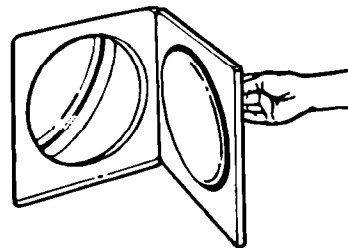

Restarting your dryer

1. Close the door.
2. Select a new cycle and temperature (if necessary).
3. Press the Start Button.

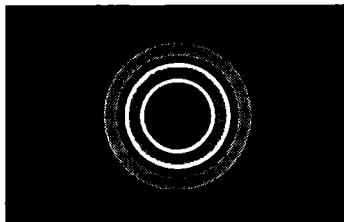

Push to start

Understanding your cycles

See the chart below for descriptions of the cycles that are on your dryer. See page 17 (if your model does not have a temperature selector) or page 18 (if your model has a temperature selector), for help in selecting the right cycle.

NOTES:

- Use the Energy Preferred Automatic Setting (+) to dry most loads.
- Shaded areas in the illustrations show cycle locations.
- The last few minutes of all cycles are without heat to make the load easier to handle.
- To help reduce wrinkling, remove the load from the dryer as soon as tumbling stops. This is important for permanent press, knits, and synthetic fabrics.

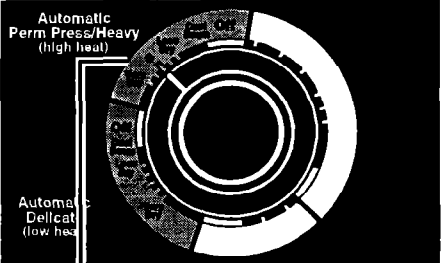
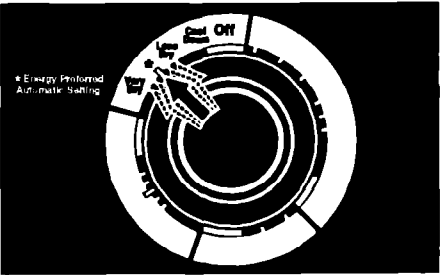
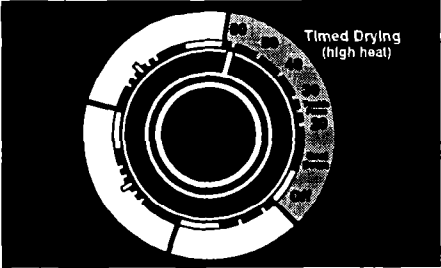
CYCLES (cycle names may vary with model)	CYCLE CONTROL KNOB (settings may vary with model)
<p>Automatic cycle</p> <p>Use an automatic cycle to dry most loads.</p> <ul style="list-style-type: none"> • The automatic cycle shuts off when your load reaches the selected dryness. • The Cycle Control Knob will not move until the load is almost dry. After the cool-down, the Cycle Control Knob automatically moves to an OFF area and tumbling stops. <p>Dry most loads using the Energy Preferred Automatic Setting (+) .</p> <ul style="list-style-type: none"> • If the load is drier than you like, select a setting closer to LESS DRY the next time you dry a similar load. • If the load is not as dry as you like, complete drying using a Timed cycle. Select a setting closer to VERY DRY the next time you dry a similar load. <p>NOTE: Some models offer high heat and low heat automatic cycles. Select the cycle to match your load.</p>	 <p style="text-align: center;">Energy preferred automatic setting</p> 
<p>Timed cycle(s)</p> <p>Use your Timed cycle to complete drying if some items are damp after automatic drying. This cycle is also useful for small loads or large bulky items.</p> <ul style="list-style-type: none"> • For a damp dry, turn the Cycle Control Knob to 30 minutes or less. (If your dryer has a Damp Dry cycle, see page 16.) <p>NOTE: Some models offer high heat and low heat timed cycles. Select the cycle to match your load.</p>	

continued on next page

OPERATING YOUR DRYER

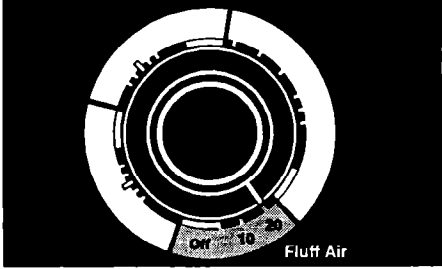
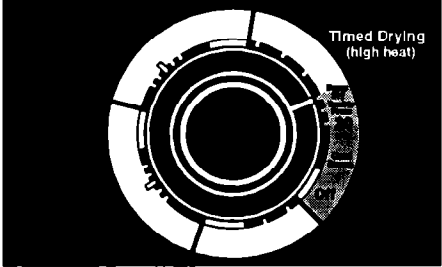
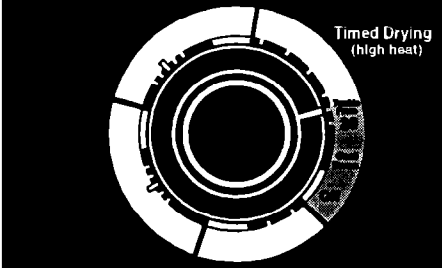
<p align="center">CYCLES (cycle names may vary with model)</p>	<p align="center">CYCLE CONTROL KNOB (settings may vary with model)</p>
<p>Fluff Air cycle (no heat)</p> <p>The Air cycle is unheated. Use this cycle to fluff or air dry bedding, plastic tablecloths, foam pillows, sneakers, etc. See Warning on page 17 or 18.</p>	 <p>The diagram shows a circular control knob with several settings. The 'Fluff Air' setting is indicated by a pointer on the right side of the knob. Other visible settings include 'Off' and 'To'.</p>
<p>Using the Damp Dry cycle (on some models)</p> <p>Use this cycle to dry items to damp level or to dry damp items that do not require an entire drying cycle. Two examples are heavy cottons, such as jeans, which you do not want to become stiff, or cotton clothes which are easier to press when damp.</p>	 <p>The diagram shows the cycle control knob with the 'Timed Drying (high heat)' setting selected. The text 'Timed Drying (high heat)' is printed next to the selected setting.</p>
<p>Using the TUMBLE PRESS® cycle (on some models)</p> <p>The TUMBLE PRESS cycle removes wrinkles from clothes that have been packed in a suitcase, or from items not removed from the dryer at the end of a cycle. Put only a few items in your dryer for best results when using this cycle. As soon as the dryer stops, fold or put the items on hangers.</p>	 <p>The diagram shows the cycle control knob with the 'Timed Drying (high heat)' setting selected. The text 'Timed Drying (high heat)' is printed next to the selected setting.</p>

Selecting the right cycle and setting

(models without a temperature selector)

Use the chart below to guide you when making drying selections. Use a Timed cycle only if the recommended automatic cycle is not available on your dryer. (Your model has cycles with one or two temperature settings.)

- Do not overdry. Overdrying can cause shrinkage, static cling, and damage to some fabrics.

⚠ WARNING

Fire Hazard

Do not dry heat-sensitive fabrics, plastic, rubber, or some stuffed items with heat. Use the Air cycle, or line dry.

Failure to do so could result in fire or damaged items.

TYPE OF LOAD <i>Check mark (✓) denotes the recommended setting. Select the setting available on your dryer.</i>	AUTO		TIMED minutes High	AIR minutes
	High	Low		
COTTONS AND LINENS Extra Heavy—Bedspreads, mattress pads, quilts Heavyweight—Towels, jeans, corduroys, work clothes Mediumweight—Sheets, cotton underwear, diapers Lightweight—Batistes, organdies, lingerie	✓ ✓ ✓	✓	20	
PERMANENT PRESS, SYNTHETICS AND BLENDS Heavyweight—Work clothes, jackets, raincoats Mediumweight—Shirts, play clothes, sheets, slacks Lightweight—Lingerie, blouses, dresses	✓ ✓	✓	20	
KNITS Heavyweight—Cottons, rayons, blends, T-shirts, slacks, shirts Mediumweight—Synthetics (polyester, acrylic, etc.), dress slacks, skirts, sweaters Lightweight—Synthetics (polyester, acrylic, etc.) and blends, lingerie, blouses, dresses	✓ ✓	✓	20	
DELICATE FABRICS Sheer curtains (2 or 3 panels), gauze, lace, etc.				20-30
RUBBER, PLASTIC, HEAT-SENSITIVE FABRICS Foam Rubber—Pillows, bras, stuffed toys Plastic—Shower curtains, tablecloths Rubber-backed rugs Olefin, Polypropylene, Sheer nylon				20-30 20-30 40-50 10-20

OPERATING YOUR DRYER

Selecting the right cycle and setting

(models with a temperature selector)

Use the chart below to guide you when making drying selections.

- Do not overdry. Overdrying can cause shrinkage, static cling, and damage to some fabrics.

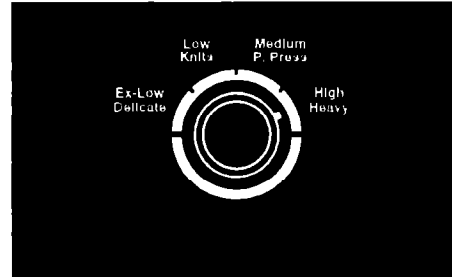

Settings may vary with model

⚠ WARNING

Fire Hazard

Do not dry heat-sensitive fabrics, plastic, rubber, or some stuffed items with heat. Use the Air cycle, or line dry.

Failure to do so could result in fire or damaged items.

TYPE OF LOAD	CYCLE	TEMPERATURE OR TIME
COTTONS AND LINENS Extra Heavy—Bedspreads, mattress pads, quilts Heavyweight—Towels, jeans, corduroys, work clothes Mediumweight—Sheets, cotton underwear, diapers Lightweight—Batistes, organdies, lingerie	Auto cycle	HIGH HIGH MEDIUM LOW
PERMANENT PRESS, SYNTHETICS AND BLENDS Heavyweight—Work clothes, jackets, raincoats Mediumweight—Shirts, play clothes, sheets, slacks Lightweight—Lingerie, blouses, dresses	Auto cycle	HIGH MEDIUM LOW
KNITS Heavyweight—Cottons, rayons, blends, T-shirts, slacks, shirts Mediumweight—Synthetics (polyester, acrylic, etc.), dress slacks, skirts, sweaters Lightweight—Synthetics (polyester, acrylic, etc.) and blends, lingerie, blouses, dresses	Auto cycle	HIGH MEDIUM EX LOW or LOW
DELICATE FABRICS Sheer curtains (2 or 3 panels), gauze, lace, etc.	Auto cycle	EX LOW or LOW
RUBBER, PLASTIC, HEAT-SENSITIVE FABRICS Foam Rubber—Pillows, bras, stuffed toys Plastic—Shower curtains, tablecloths Rubber-backed rugs Olefin, Polypropylene, Sheer nylon	Air cycle	20-30 min 20-30 min 40-50 min 10-20 min

Caring For Your Washer/Dryer

In This Section		Page	Page
Maintenance-every load	19	Tips for caring for your washer/dryer	22
Maintenance-as needed	19	Care during periods of non-use	22

Dryers require regular maintenance. Follow the suggestions below to maintain your dryer properly.

Maintenance-every load

Cleaning the lint screen

The lint screen is located at the front of the dryer door opening. **Clean it before each load.** A screen blocked by lint can increase drying time.

1. Open the door and pull the lint screen straight up.
2. Roll lint off the screen with your fingers. Do not rinse or wash the screen to remove lint. Wet lint is hard to remove.
3. Push the screen firmly back into place and close the door.

⚠ CAUTION

Product and Fabric Damage Hazard

Do not run the dryer with the lint screen loose, damaged, blocked or missing. Doing so can cause overheating and damage to both the dryer and fabrics.

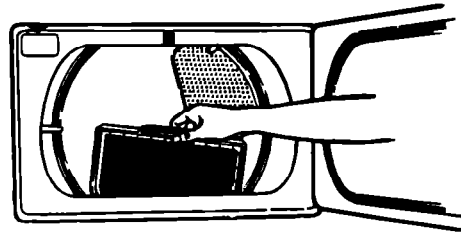

Maintenance-as needed

Use the following suggestions about cleaning and lint removal to maintain your washer/dryer and keep it operating efficiently.

Cleaning the lint screen area

Periodically remove the dryer lint screen and vacuum the opening. Use the long, thin attachment (crevice tool) on your vacuum cleaner.

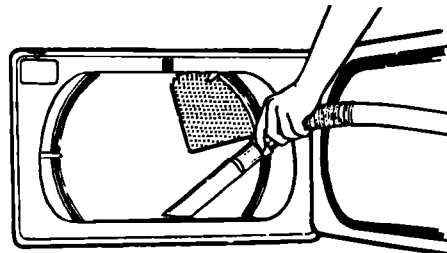

CARING FOR YOUR WASHER/DRYER

Cleaning a clogged lint screen

Laundry detergents and fabric softeners can cause a residue buildup on the lint screen. A clogged lint screen can extend drying times. Clean the lint screen every six months, or more frequently, if it becomes clogged due to a residue buildup. Use the following method:

1. Wet both sides of lint screen with hot water.
2. Wet a nylon brush with hot water and liquid detergent.
3. Scrub lint screen with the brush until all residue buildup is removed.
4. Rinse with hot water.
5. **Thoroughly** dry lint screen with a clean towel and replace in dryer.

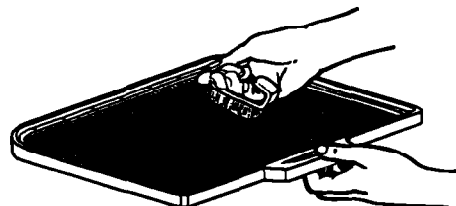

Cleaning the washer/dryer interior

Washer:

- If the washer interior needs cleaning, put 1 cup (250 mL) of chlorine bleach and 2 cups (500 mL) of detergent in the washer. Run through a complete cycle using hot water.

Dryer:

⚠ WARNING

Electrical Shock, Personal Injury and Fire and Explosion Hazard

- Turn off the electrical power before cleaning the interior.
 - Make sure the dryer is cool.
 - Use nonflammable cleaner.
- Failure to do so could result in electrical shock or injury, fire or explosion.

Garments which contain unstable dyes, such as denim blue jeans or brightly colored cotton items, may discolor the dryer interior.

If you want to remove stains from the dryer drum, use powdered laundry detergent.

1. Make a paste with detergent and very warm water.
2. Apply paste to a soft cloth and scrub area until all excess dye is removed.
3. Wipe thoroughly with a damp cloth.
4. Tumble a load of rags to dry.

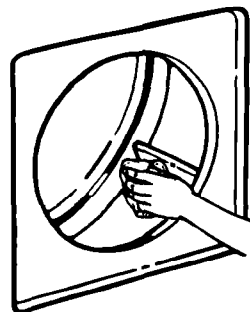

Removing accumulated lint

Lint can gather inside the dryer and be fuel for a fire. It is recommended that lint be removed every 2 to 3 years, or more often, depending on dryer usage. Cleaning should be done by a qualified person. If you have any questions, please call our Consumer Assistance Center at 1-800-253-1301.

⚠ WARNING

Electrical Shock, Personal Injury and Product Damage Hazard

- Unplug the power supply cord or turn off the electrical power before removing dryer panels.
- Make sure the dryer is cool.
- Dryer parts can have sharp edges. Use care when handling.
- More than one person is required to lift, tilt or move machine because of its weight and size.
- Tuck only from rear.

Failure to follow the above instructions could result in electrical shock, personal injury or product damage.

1. Unplug the power supply cord or turn off the electrical power.
2. Remove back panel. See Installation Instructions.
3. Remove lint from shaded area in illustration with a soft brush or vacuum cleaner. Avoid damaging wires, thermostats, funnel (gas), or ignitor (gas).
4. Replace panel; reconnect and level dryer again, if necessary.

Heat inlet duct Thermostats Motor

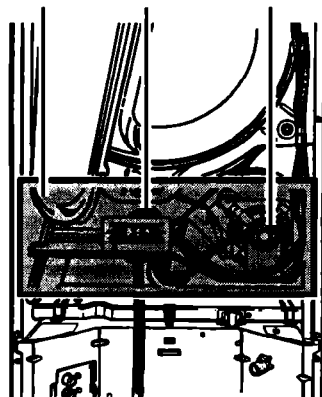

Electric dryer with back panel removed

Tips for caring for your washer/dryer

- Wipe up detergent, bleach and other spills with a soft, damp cloth or sponge as they occur.
- Remove hard water deposits using only cleaners labeled as washer safe.
- After tinting or dyeing, put chlorine bleach and detergent in the washer. Run through a complete cycle using hot water to remove excess dye or tint. If staining occurs on following loads, repeat the process.
- Sharp or metal objects can damage your washer. Check pockets for pins, clips, money, bolts, nuts, etc. Do not lay these objects on your washer after emptying pockets.

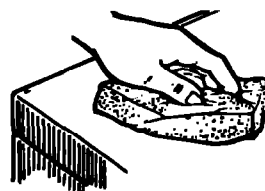

NOTE: Operate your washer/dryer only when you are at home.

Care during periods of non-use

Winter storage or moving care

Install and store your washer/dryer where it will not freeze. Because some water stays in the washer, freezing can damage it. If your washer/dryer is stored or moved during freezing weather, winterize it.

1. Shut off both water faucets. Disconnect the drain water inlet hoses.
2. Put 1 quart (1 L) of R.V.-type antifreeze in the washer basket.
3. Run washer on a drain and spin setting for about 30 seconds (see page 10) to mix antifreeze and water.
4. Unplug power supply cord.

To use the washer again:

1. Flush water pipes and hoses.
2. Reconnect water inlet hoses.
3. Turn on both water faucets.
4. Reconnect power supply cord.
5. Run the washer through a complete cycle with 1 cup (250 mL) of detergent to clean out antifreeze.

Non-use/vacation care

1. Unplug power supply cord or turn off electrical power.
2. Clean lint screen.
3. Turn off water supply leading to your washer/dryer. This will help avoid accidental flooding while you are away (for example, due to a water-pressure surge).

Laundry Tips

In This Section			
	Page		Page
Before you wash or dry	23	Saving energy	30
Removing stains	25	Drying special-care items	31
Water usage guide	28	Solving laundering problems	34
Washing special-care items	29	Using laundry aids	35

This section reviews proper laundering techniques, gives you additional laundering information, and discusses causes or solutions to common laundering problems.

Before you wash or dry

Before using your washer/dryer, see pages 3-5 for Important Safety Information.

- Close zippers, snaps and hooks to avoid snagging other items. Remove pins, buckles and other hard objects to avoid scratching the washer interior or the dryer drum. Remove unwashable trim and ornaments, or heat-sensitive trim that can be damaged by drying.
- Stained or wet garments should be washed promptly for best results.
- Check garments to make sure all spots and stains were removed during the wash. See pages 25-27 for pretreatment and stain removal information. If stains were not removed, do not tumble dry. Heat may permanently set stain. Soiled items can also leave stains on the dryer drum. These stains can be picked up by other items in the load.
- Turn down cuffs and brush away lint and dirt.
- Turn synthetics inside out to avoid pilling.
- Mend tears, loose hems, and seams.
- Sharp or metal objects can damage your washer. Check pockets for pins, clips, money, bolts, nuts, etc. and turn pockets inside out. Do not lay these objects on your washer after emptying pockets.
- Turn lint takers and dark items inside out to help prevent lint pickup.
- Tie strings and sashes so they will not tangle.
- Place small items such as baby socks or hankies in a mesh bag for easier removal.
- Articles to be ironed should be removed from the dryer while still damp.



Sorting

- Items properly sorted for washing are usually properly sorted for drying. Separate heavily soiled items from lightly soiled ones even if they would normally be washed together. Separate lint givers (towels, chenille) from lint takers (corduroy, synthetics, permanent press). When possible, turn lint takers inside out.
- Separate heavy fabrics (denim, towels) from light fabrics (synthetics, permanent press).
- Separate dark from light colors; colorfast from noncolorfast.



Load sizes

- Drop items into washer loosely. Fill to the top of the basket. Do not pack or wrap items around agitator. Items should move easily through wash water for best cleaning and wrinkle-free results. Watch for rollover. Items should sink and reappear later.
- To reduce wrinkling, permanent press and synthetic knits should have more room to move in the water than heavy items (towels, jeans).
- Do not overload the dryer. Overcrowding causes poor cleaning, uneven drying and wrinkling, and can cause items to wear out faster (because of pilling).



LAUNDRY TIPS

- Mix large and small items in each load. Load evenly to maintain washer balance. An off-balance load can make the machine vibrate during spin. Load the dryer by the amount of space items take up, not by their weight.



- Reduce wrinkling of permanent press and synthetics by drying smaller loads and removing items from the dryer as soon as tumbling stops.

- For better tumbling action when drying only a few small items, add one or two lint-free towels. This also prevents small, lightweight items from blocking airflow.
- You may need to rearrange large items (sheets, blankets, tablecloths) during a drying cycle to reduce balling or rolling up.

Washer loading suggestions

For these suggested full-sized loads, use the highest water level setting.

LARGE CAPACITY WASHERS			
Heavy Work Clothes 2 pair pants 3 shirts 3 pair jeans 1 coverall	Towels 8 bath towels 8 hand towels 10 wash cloths 1 bathmat	Permanent Press 1 double sheet 1 tablecloth 1 dress 1 blouse 2 slacks 3 shirts 2 pillowcases	Mixed Load 2 double or 1 king size sheet 4 pillowcases 6 T-shirts 6 pair shorts 2 shirts 2 blouses 6 handkerchiefs
Knits 2 slacks 2 blouses 4 shirts 4 tops 2 dresses	Delicates 2 camisoles 4 slips 4 panties 2 bras 2 nighties		

Removing stains

Stained, heavily soiled or greasy items may need to be prewashed or soaked for best results. Soaking helps remove protein-type stains like blood, milk, or grass. Prewashing helps loosen soil before washing.

Prewashing or soaking

Use warm water for soaking or prewashing stained laundry. Hot water can set stains.

Stain removal rules

- Most stains are easier to remove when they are fresh. Old or set stains may not come out. Follow package directions for pretreatment products.
- Before treating any stain, find out ...
 1. What kind of stain it is.
 2. What kind of fabric it is and if it is colorfast. (Check label.)
 3. How old the stain is. (Washing and drying can set some stains.)
- Start with cold or warm water. Hot water can set some stains.
- When bleach is recommended, use a bleach that is safe for the fabric. Dilute chlorine bleach.
- Test stain removers on an inside seam or hidden corner of the item to see if the color is removed.
- Put the stained area face down on a paper towel or white cloth. Apply the stain remover to the back of the stain. This can force the stain off the fabric instead of through it.
- Meat tenderizer or enzyme presoaks help break down some protein stains so they are easier to remove.
- Use nonflammable fabric cleaner in a well-ventilated room.

LAUNDRY TIPS

Stain removal guide

STAIN	TO REMOVE
Alcoholic beverage	These stains turn brown with age, so treat immediately. Sponge or soak fresh stains with cold water. Wash. If stain remains, soak 15 minutes in a solution of lukewarm water, liquid detergent and a few drops of white vinegar. Rinse. Wash.
Blood	Rinse immediately or soak in cold water with enzyme presoak for 30 minutes or longer. Rinse. Rub detergent into any remaining stains. Rinse. If stain remains, put a few drops of 3% hydrogen peroxide on stain for 3-5 minutes. Rinse thoroughly. Wash.
Chewing gum	Use ice to make gum hard. Scrape off what you can. Sponge with a nonflammable fabric cleaner. Let dry. Wash.
Chocolate or coffee	Sponge immediately with a nonflammable fabric cleaner or apply a prewash soil and stain remover. Rinse. Wash. If stain remains, apply a liquid detergent to stain or soak in warm water with an enzyme presoak. Rewash.
Crayon and candle wax	Scrape off excess with a dull knife. Place fabric between two blotters or facial tissue. Press with warm iron. Remove color stain with nonflammable fabric cleaner. Hand wash until stain is gone. If full load is crayon stained, take to cleaners or coin-operated dry cleaning machine.
Cream, milk or ice cream	Sponge with a nonflammable fabric cleaner, or a prewash soil and stain remover. Rinse. Wash. Repeat if necessary. If stain remains, apply a few drops of liquid detergent and a few drops of ammonia. Blot dry and rinse. If stain remains, soak in an enzyme presoak. Wash.
Deodorants and anti-perspirants	Light stain: Treat with liquid detergent or your regular laundry detergent. Wash in hottest water safe for fabric. Heavy stain: Place face down on towel and treat with a paste of ammonia and all-fabric bleach. Let stand for 30 minutes. Wash in hottest water safe for fabric.
Fat, grease or oil	Items soiled with vegetable or cooking oil should not be washed or dried. See Vegetable/Cooking Oil Warning on page 5. For other types of greasy stains, use one of the methods below: <ul style="list-style-type: none"> • Use pretreatment stain remover. Follow label directions. Wash in hottest water safe for fabric. • Use talcum powder to absorb as much grease as possible. Sponge with a nonflammable fabric cleaner. Rinse. Wash. • Treat with liquid detergent or rub a detergent paste on the stain. Wash using hottest water safe for fabric.
Fruit stains	Fresh stains: Soak immediately in cool water. Wash. If stain remains, cover area with a paste made of all-fabric bleach, a few drops of hot water and a few drops of ammonia. Wait 15 to 30 minutes. Wash. Old stains: Sponge with white vinegar. Rinse. Repeat procedure for fresh stains.
Grass or green vegetables	Soak in warm or cold water with an enzyme presoak for at least 30 minutes, or sponge with denatured alcohol. Wash in water temperature and bleach safe for the fabric. For colored fabrics, check colorfastness before applying alcohol. For acetate, sponge with a nonflammable fabric cleaner. If stain remains, bleach with 3% hydrogen peroxide. Rinse. Rewash.
Ink or ballpoint pen ink	Spray stain with an aerosol hair spray or rubbing alcohol. Sponge stain continuously until all bleeding stops. Let dry. Repeat if necessary. Wash. If stain remains, bleach if safe for fabric. (India and other indelible inks are almost impossible to remove completely.)

LAUNDRY TIPS

STAIN	TO REMOVE
Iron or rust	Colored or noncolorfast items: Apply lemon juice and salt. Place in the sun to dry. Rinse thoroughly. Repeat if necessary. White or colorfast items: Try a rust remover. Test first on inside seam or hem. Some rust removers are not washer safe. Follow package directions.
Ketchup or tomato products	Sponge immediately with a nonflammable fabric cleaner or apply a prewash soil and stain remover. Rinse. Wash. If stain remains, apply a liquid detergent to stain or soak in warm water with an enzyme presoak. Rewash.
Lipstick	Apply nonflammable fabric cleaner or prewash soil and stain remover. Blot with absorbent material. Repeat if necessary. Rinse. If stain still remains, rub with liquid detergent. Wash.
Meat juice, egg	Scrape off excess with a dull knife. Soak in cold or warm water with enzyme presoak at least 30 minutes, or treat stains with a nonflammable fabric cleaner. Wash.
Mildew	Wash in hottest water safe for fabric. If stain remains, soak in warm water and an all-fabric bleach for 15 to 30 minutes. Rewash. (Old mildew stains are almost impossible to remove. Mildew fungus destroys or weakens fabrics.) An alternative to bleach is to treat with salt and lemon juice and dry in direct sunlight. Rinse and rewash. Mildew may form if wet or damp laundry remains in your washer for extended periods of time. To prevent mildew, promptly dry laundry after washing.
Mustard	Treat immediately. Scrape off excess mustard. Sponge with a nonflammable fabric cleaner or a prewash soil and stain remover. Rinse. Work liquid detergent and a few drops of vinegar into stain. Rinse. If stain remains, apply 3% hydrogen peroxide. Rinse and wash.
Paint	Hand wash paint-stained items. Water base: Treat stains while still wet. (These paints cannot be removed after they have dried.) Rinse in warm water to flush out paint. Sponge with a nonflammable fabric cleaner. Rinse. Wash. Oil base: Scrape off fresh paint. Sponge with a nonflammable fabric cleaner or treat stain with recommended thinner. While stain is still wet with solvent, rub liquid detergent into it. Wash with hottest water safe for fabric.
Perspiration	Remove stains before ironing. Perspiration stains may weaken fabric. Wash or sponge stain thoroughly with detergent and warm water. If perspiration has changed the color of the fabric, use one of the following treatments: Fresh stains: Apply ammonia to stain. Rinse. Launder to remove ammonia odor. Old stains: Apply white vinegar to stain. Rinse. Launder to remove vinegar odor.
Scorch	Severe scorch cannot be removed. Wet stain with 3% hydrogen peroxide. Cover with a dry cloth and press with an iron as hot as is safe for fabric. Rinse well. Wash. OR Wet with lemon juice and spread in the sun to dry. Wash.
Soft drinks	Sponge immediately with cold water and alcohol. Heat and detergent may set stain.

Water usage guide

Water temperature

WASH	RINSE	USE FOR	COMMENTS
HOT 130°F (54°C) or above	COLD	<ul style="list-style-type: none"> • Heavy soils • Work clothes • Sturdy whites and colorfast pastels • Diapers 	<ul style="list-style-type: none"> • Gives best cleaning for heavy soils. • Removes oils, perspiration, greasy soils and stains. • Prevents graying and yellowing.
WARM 90°-110°F (32°-44°C)	COLD	<ul style="list-style-type: none"> • Light and moderate soils • Dark or noncolorfast colors • Moderately soiled permanent press • Nylons, polyesters, acrylics, silks, woolens • Knits and delicate fabrics • Prewash, soak 	<ul style="list-style-type: none"> • Safe for most fabric finishes. • Less fading and dye bleeding. • Reduces wrinkling.
COLD 70°-90°F (21°-32°C)	COLD	<ul style="list-style-type: none"> • Very lightly soiled items • Moderately soiled items if extra detergent is added • Extra sensitive colors (noncolorfast) • Rinsing, for all fabrics 	<ul style="list-style-type: none"> • Saves hot water. • Less effective cleaning than hot or warm water. • Use longest wash time in cycle selected. • Use liquid detergent, or dissolve powdered detergent in warm water before adding to cold wash water. • Pretreat spots, stains and heavy or greasy soils.

To check your hot water temperature with a candy or cooking thermometer:

1. Fill a pan with the hottest water available from the faucet that will fill your washer.
2. Place a candy or cooking thermometer in water to check the temperature.

If you do not have a faucet at your wash site, collect water from the faucet closest to your washer/dryer.

NOTE: In wash-water temperatures colder than 70°F (21°C):

- Detergents do not dissolve well.
- Soils are difficult to remove.
- Some fabrics will retain wear wrinkles and may have increased pilling.

Water hardness

Many poor washing results can be traced to wash-water hardness. To check your water hardness:

- City water—ask your city water company.
- Well water—call your Cooperative Extension Service.

Ask for the mineral content in grains-per-gallon or parts-per-million. If your water is 9 or more grains-per-gallon or more than 153 parts-per-million:

- Consider installing a water softener.
- Use more detergent.
- Use a packaged water conditioner.
- Do not use soap.

Washing special-care items

Most garments and household textiles have care labels with laundering instructions. Always follow label directions when they are available. General washing instructions for some special washables are included in this section.

<p>Blankets, electric and woolen</p>	<p>Pretreat spots and stains. Select water temperature, cycle, and time according to the type of blanket being washed. Two rinses may be necessary. If manufacturer recommends machine washing:</p> <ol style="list-style-type: none"> 1. Measure blanket before washing. 2. Add mild detergent to washer. Fill and agitate briefly to dissolve detergent. 3. Stop washer. Load blanket evenly around agitator. Soak 10 to 15 minutes. 4. Set Cycle Control Knob to Drain and Spin. Start washer. Spin 1 to 2 minutes. 5. Fill washer for final rinse. Stop washer. Allow to soak. 6. Set Cycle Control Knob to Drain and Spin. Start washer. Allow washer to finish cycle. 7. Lay blanket on flat surface and block by gently stretching to original measurement. Woolens tend to shrink more the first time they are washed. This is normal.
<p>Curtains, drapes, slipcovers</p>	<p>Wash small loads. Crowding will cause wrinkling.</p> <ol style="list-style-type: none"> 1. Shake or vacuum to remove loose dirt. 2. Wash following manufacturer's instructions. <p>NOTES:</p> <ul style="list-style-type: none"> • Sun-damaged curtains and draperies will tear whether hand or machine washed. • Replace slipcovers while still slightly damp. They will dry to fit tightly.
<p>Diapers</p>	<p>When using chlorine bleach for soaking, add detergent to load. Avoid overuse of fabric softeners. Absorbency will be reduced.</p> <ol style="list-style-type: none"> 1. Rinse immediately. Soak in a solution of lukewarm water and a small amount of detergent until you are ready to wash them. You may wish to use bleach or a special soaking product when soaking. 2. Spin excess water from diapers before washing. 3. Wash diapers as you would wash white cottons and linens.
<p>Elastic, spandex</p>	<p>Elastic picks up oil from the body. Oil can damage elastic. Wash often to help reduce the damage. Use warm water and sufficient detergent to remove oils.</p>
<p>Flame-retardant clothing</p>	<p>Items will be clearly labeled as flame-retardant. Follow manufacturer's instructions to retain flame retardant qualities.</p>

continued on next page

LAUNDRY TIPS

Fiberglass materials	Do not wash fiberglass materials in your washer. Glass particles could stick to the next load and cause skin irritation.
Knits	Knits are comfortable to wear because they stretch. However, this means that knits are more likely to be stretched and damaged when washed (especially bulky knits). Knits made of synthetic fabrics such as polyester, nylon, and acrylic tend to keep their original shape more than a knit made of cotton or ramie. <ol style="list-style-type: none"> 1. Close zippers, fasten hooks and eyes to prevent snagging. 2. Wash small loads to reduce pilling and lint.
Pillows, stuffed toys	Washing feather pillows is not recommended unless they are dryer dried. <ol style="list-style-type: none"> 1. Add detergent then partially fill washer with water; agitate until detergent is dissolved. 2. Place two pillows on opposite sides of the agitator to balance the load. 3. Allow washer to fill completely and continue through the cycle. 4. Stop the washer occasionally to press air from item(s) being washed.
Plastic, rubber items	Treat as delicate items. Wash in warm water. Wash small items in a mesh bag.
Quilts, bedspreads	Do not wash cotton-filled comforters unless they are quilted or stitched; tucked cotton batting tends to slip and become lumpy.
Scatter rugs	<ol style="list-style-type: none"> 1. Shake or vacuum to remove loose dirt. 2. Wash more than one small rug at a time. If you wash only one rug, add bath towels to balance the load. A larger rug should be distributed around the agitator to balance the load.
Snowsuits, jackets, etc.	<ol style="list-style-type: none"> 1. Wash only one or two items at a time. Load evenly around the agitator. 2. Stop the washer occasionally to press air from item(s) being washed. 3. Two rinses may be necessary.

Saving energy

- Use hot water only when washing heavy, greasy soils or whites.
- Use cold rinses.
- Wash full loads.
- Use lower water levels when washing small loads.
- Avoid rewashing. Use enough detergent; pretreat stains or heavy soils; do not overload; use the cycles and wash times recommended for the fabric and soil; sort properly.
- Use your washer/dryer during off-peak hours—usually early morning and late evening. (Ask your power company.)
- Use your automatic cycle to dry most loads.
- Dry only full loads without overdrying.
- Avoid overloading dryer, adding wet items to a partly dried load, or opening the door unnecessarily.
- Plan your laundry to dry one load after another. A warm dryer shortens drying time.
- Shorten drying times by exhausting dryer properly and cleaning exhaust duct as needed.
 - Keep the lint screen clean.
 - Use your dryer in a room where room air temperature is above 45°F (7°C).
 - Sort loads by fabric weight and type.

Drying special-care items

Most garments and household textiles have care labels with laundering instructions. Always follow label directions when they are available. General drying instructions for some special washables are included in this section.

<p>Air drying (heat sensitive items)</p> <hr/> <p>Heat-sensitive fabrics</p> <ul style="list-style-type: none"> • Olefin, polypropylene, sheer nylon • Cotton and canvas shoes <p>Pillows, stuffed toys</p> <ul style="list-style-type: none"> • Feather, foam, polyester <p>Plastic, rubber</p> <ul style="list-style-type: none"> • Shower curtains, tablecloths, baby panties <p>Scatter rugs</p>	<p>Heat sensitive fabrics, plastic, rubber or some stuffed items require drying without heat. Use an Air setting or line dry. The Air setting is useful for fluffing bedding and pillows, and dusting draperies and clothing. See Warning on page 17 or 18.</p> <p>Follow care label directions.</p> <p>If shoes can be machine laundered:</p> <ol style="list-style-type: none"> 1. Place several bath towels in the dryer to act as a buffer, or place shoes on drying rack if your dryer has one. 2. If rubber or foam rubber materials are part of the shoe, use an Air setting. For other materials, see page 17 or 18 for cycle, time, or temperature recommendations. 3. Remove shoes from dryer while still damp and allow to air dry. <p>If manufacturer recommends machine drying, dry one pillow at a time and:</p> <ol style="list-style-type: none"> 1. Make sure coverings are securely stitched. 2. Shake and fluff the items by hand several times during the cycle. 3. Make sure pillows are completely dry. Feather pillows take a long time to dry. <p>Follow care label directions.</p> <p>Follow care label directions.</p>
<p>Blankets and woolens</p> <hr/> <ul style="list-style-type: none"> • Cotton, rayon, synthetic blankets • Electric blankets, electric sheets, woolen blankets, washable woolen garments 	<p>Machine drying knitted woolens is not recommended. Block to shape when wet and allow to air dry. Line dry blankets in shade on a breezy day over two lines. Pin edges together and straighten them. When partly dry, turn the blanket over, re-pin and re-straighten. When dry, brush nap.</p> <p>Dry as recommended for permanent press fabrics on page 17 or 18.</p> <p>If manufacturer recommends machine drying:</p> <ol style="list-style-type: none"> 1. Place one or two dry towels in the dryer and preheat 3-5 minutes on a high setting. This will dry blankets faster and help avoid pilling. 2. Put blanket in dryer with warm towels. Set control for 20 minutes. 3. Check after 10 minutes. Remove when still damp. Overdrying and long tumbling can cause shrinking and pilling. 4. Place blanket on flat surface or over two lines to finish drying. Gently stretch to original size and shape. 5. When completely dry, brush gently to raise nap. Press binding with cool iron if needed.

continued on next page

LAUNDRY TIPS

<p>Curtains, slipcovers</p> <ul style="list-style-type: none"> • Draperies, slipcovers • Sheers, some synthetic curtains • Bonded or laminated fabrics 	<p>Remove drapery weights and hooks before laundering.</p> <ol style="list-style-type: none"> 1. Use lowest temperature or an Air setting. 2. Leave room in dryer for load to fluff. 3. Remove from dryer while slightly damp. Do not overdry. <p>For slipcovers, replace slipcovers while still slightly damp. They will dry to fit tightly.</p> <p>Dry only a few minutes.</p> <p>Do not overdry or tumble in high heat. Overdrying loosens the adhesive and causes fabrics to separate.</p>
<p>Diapers, baby clothes</p>	<p>Wash and dry small items in a mesh bag or pillowcase for convenient handling.</p> <ol style="list-style-type: none"> 1. Dry according to fabric and cycle settings listed on page 17 or 18. 2. Remove diapers and cotton knit items while still slightly damp. They will feel softer, shrink less and be easier to fold.
<p>Elastic items</p>	<p>Dry at lowest temperature setting. Remove from dryer while still slightly damp.</p>
<p>Fiberglass materials</p>	<p>Do not machine wash or dry fiberglass materials. Small particles can stick to fabrics washed or dried in following loads and cause skin irritation.</p>
<p>Flame-retardant finishes</p>	<p>Some items have been treated with a flame-retardant finish to improve their resistance to burning. Such items are clearly labeled. To retain flame-retardant qualities through continuous use and washing, clean and dry according to the manufacturer's instructions.</p>
<p>Napped items</p> <ul style="list-style-type: none"> • Corduroy, velveteen 	<p>Dry separately or with similar colors to avoid lint transfer. Follow care label directions.</p> <ol style="list-style-type: none"> 1. Dry according to fabric and cycle settings shown on page 17 or 18. 2. Remove from dryer while there is still a trace of moisture. 3. Smooth, reshape and air dry before putting away.
<p>Quilted, down-filled items</p>	<p>Follow care label instructions.</p> <ol style="list-style-type: none"> 1. Dry one at a time. 2. Remove from dryer and shake or fluff the item during the drying cycle. 3. Smooth and reshape before putting away.
<p>Snowsuits, jackets</p> <ul style="list-style-type: none"> • Nylon, polyester-base 	<p>Check label for fiber content, then see page 17 or 18 for cycle and temperature recommendations.</p> <p>Follow care label directions.</p> <ol style="list-style-type: none"> 1. Dry garment for about 10 minutes. Remove and turn inside out. Dry for 10 more minutes. 2. Remove from dryer immediately and hang on a nonrusting hanger to finish drying. This will help eliminate wrinkles.

LAUNDRY TIPS

Tinted, dyed or noncolorfast items	Dry according to fabric, weight and care label instructions. Wipe the dryer drum carefully to remove any dye or lint that can be transferred to other loads. See "Cleaning the washer/dryer interior" on page 20.
Towels	Select cycle according to fabric type. Some towels, particularly those made of a blend of synthetic fibers and natural fibers (polyester and cotton blends), may shed more lint than other towels causing your dryer's lint screen to get full faster. Be sure to remove lint from the dryer lint screen before and after drying new towels.
Washable knits	Do not overdry knits. Overdrying can cause shrinking and static cling. <ol style="list-style-type: none">1. Select cycle according to fabric and construction.2. Turn synthetics and blends inside out when drying to avoid pilling.3. Remove cotton and rayon knits while still slightly damp. Stretch into shape and lay flat to finish drying.

Solving laundering problems

Most laundering problems are easily solved if you understand the cause. Check the following list for problems you may have and possible causes. If you need additional help, check the "Assistance or Service" section of this book.

PROBLEM	CAUSE
Brown, yellow stains	<ul style="list-style-type: none"> • Chlorine staining • Iron in water heater or pipes • Iron and manganese in water
Dye transfer	<ul style="list-style-type: none"> • Improper sorting • Load not immediately removed from washer after end of cycle
Gray whites, dingy colors	<ul style="list-style-type: none"> • Improper sorting • Water temperature too low • Not enough detergent • Using soap in very hard water (use detergent if you have hard water)
Greasy looking spots	<ul style="list-style-type: none"> • Undiluted fabric softener or fabric softener poured directly on load • Fabric softener in wash water • Not enough detergent • Improper use of dryer fabric softener • Drying soiled items
Lint	<ul style="list-style-type: none"> • Improper sorting • Paper or tissue in pockets • Pilling being mistaken for lint • Overloading • Not enough detergent • Clogged lint filter (models with manual clean lint filter) • Clogged dryer lint screen • Static electricity is attracting lint
Load too wet after spin	<ul style="list-style-type: none"> • Cold rinses • Lid is opened before spinning is completed
Shrinking	<ul style="list-style-type: none"> • Fabric type (some knits stretch during manufacturing—laundering returns fabric to original size) • Care label directions not followed • Items overdried
Slow drying	<ul style="list-style-type: none"> • Large amount of moisture in the load • Cold rinse water • Room temperature below 45°F (7°C) • Dryer improperly exhausted • Clogged lint screen • Improper electrical supply
Snags, rips, holes	<ul style="list-style-type: none"> • Items damaged before washing • Misuse of chlorine bleach • Sharp articles not removed from pockets • Overloading • Fasteners not fastened

PROBLEM	CAUSE
Static electricity	<ul style="list-style-type: none"> • Load overdried • Fabric softener not used • Synthetics, synthetic blends, permanent press, and knits in load
Stiff, rough fabrics (usually cottons)	<ul style="list-style-type: none"> • Using soap in very hard water (use detergent if you have hard water) • Not enough detergent • Line drying
Twisting, tangling	<ul style="list-style-type: none"> • Overloading • Improper loading (do not wrap large items around agitator)
Wrinkling	<ul style="list-style-type: none"> • Overloading • Load not immediately removed from washer after end of cycle • Improper rinse temperature • Cycle selection is incorrect (based on fabric type)
Yellow areas (from body oils)	<ul style="list-style-type: none"> • Water temperature too low • Not enough detergent

Using laundry aids

Follow package instructions when using laundry aids. (See "Removing Stains" on pages 25-27, for more information.)

Chlorine bleach

- Use bleach dispenser if your machine has one. (See page 13.)
- If your washer does not have a bleach dispenser:
 1. Let the washer fill and begin agitating the load.
 2. Measure bleach. Never use more than 1 cup (250 mL) for a full load. Dilute measured bleach in 1 quart (1 L) of water.
 3. Add bleach to the wash cycle so it can be removed in the rinse cycle. Pour bleach around agitator, not directly on load.
- Follow directions on care labels. Do not use chlorine bleach on wool, silk, spandex, acetates or some flame-retardant fabrics.
- When soaking with chlorine bleach, add detergent to soak water.

NOTE: Undiluted bleach will damage any fabric it touches. The damage appears as rips, holes, tears, or color loss and may not show up until several washings later.

All-fabric bleach

- Powdered or liquid all-fabric bleach may be used on all types of fabrics.
- Do not use all-fabric bleach in the bleach dispenser because it may clog.

Detergent

- Using too little detergent is a common cause of laundry problems. Follow manufacturer's directions. Measure accurately, especially when using ultra detergents. Package directions are usually based on:
 - moderate water hardness (4-6 grains)
 - lightly soiled items
 - normal mix loads.
- Use more detergent for:
 - hard water –full loads
 - cooler wash water –heavily soiled items.
- Do not judge the amount of detergent to use by the amount of suds in the machine. Low sudsing detergents do not create as many suds as normal sudsing detergents.
- If the recommended amount of normal sudsing detergent creates too many suds or suds are present in the rinse water, try a low sudsing detergent.

LAUNDRY TIPS

Fabric softeners (washer)

- Use fabric softener dispenser if your machine has one.
- If your washer does not have a fabric softener dispenser, add diluted fabric softener only in the final rinse.
- Always dilute fabric softeners with 1/2 to 1 cup (125 to 250 mL) warm water. Undiluted fabric softener can stain fabrics.
- Fabric softeners should not be mixed with other laundry products because greasy stains may form. If stains form, remove by wetting the stain and rubbing with liquid detergent or a bar of soap. Rewash the stained item.
- Too much fabric softener can make some items (diapers and towels) nonabsorbent. If this happens, use less fabric softener or do not use it every time.

Fabric softeners (dryer)

- Put fabric softener sheet on top of the load **before starting the dryer**. Do not add fabric softener sheet after the cycle has started. Instant heat can cause the fabric softener to spot fabrics.
- Some fabric softeners can clog the lint screen and slow drying. Use fabric softeners labeled as dryer safe.

WARNING

Fire or Explosion Hazard

- Store flammable solvents or liquids away from your washer.
- Dry cleaning solvents or fluids should not be put directly into your washer.
- Items treated with solvents should be rinsed and air dried before washing in your washer.

The fumes from these substances can create a fire hazard or explosion.

Personal Injury Hazard

- Never use chlorine bleach with ammonia or acids. Hazardous fumes can form.
- Keep stain removal products out of the reach of children ... preferably in a locked cabinet.

IF YOU NEED ASSISTANCE OR SERVICE

If You Need Assistance Or Service

1. Before calling for assistance ...



Is your water turned on?

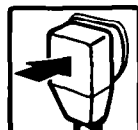

Is the power cord plugged in?



Is lint screen clogged with lint?

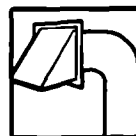

Is exhaust duct or outside exhaust hood clogged with lint?

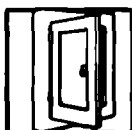

Have you blown a fuse or tripped the circuit breaker?

If you need more help, check the chart below.

PROBLEM	CHECK THE FOLLOWING
Washer will not fill	Is the power cord firmly plugged into a live circuit with proper voltage? Has a household fuse blown or circuit breaker tripped? Has a time-delay fuse been used? Are both hot and cold water faucets open? Are the water supply hoses kinked? Is the Cycle Control Knob set and pulled out?
Washer does not spin	Is the lid closed? Is the power cord firmly plugged into a live circuit with proper voltage? Has a household fuse blown or circuit breaker tripped? Has a time-delay fuse been used?
Washer stops during a cycle	Washer pauses briefly at different times in each cycle. These pauses are normal. Is the power cord firmly plugged into a live circuit with proper voltage? Has a household fuse blown or circuit breaker tripped? Has a time-delay fuse been used?
Washer fills and drains without running	Is the Cycle Control Knob pointing to a number in the cycle?
Washer drains during wash and rinse cycles, or water siphons out	Adjust the drain hose so that it is higher than the water level in the washer.

IF YOU NEED ASSISTANCE OR SERVICE

PROBLEM	CHECK THE FOLLOWING
Dryer will not run	Is the power cord firmly plugged into a live circuit with proper voltage? Has a household fuse blown or circuit breaker tripped? Has a time-delay fuse been used? Is the dryer door firmly closed? Did you firmly push the Start Button? Are the controls set in an ON position?
Dryer will not heat	Is the cycle in the last few minutes? (There is no heat during that time.) Has a household fuse blown or circuit breaker tripped? Has a time-delay fuse been used? If you have a gas dryer, are the valves open on both the dryer and the supply line?
Drying time too long	Is your lint screen clean? (See the "Slow drying" section of the table on page 34 for additional information.) Is your exhaust duct or outside exhaust hood clogged with lint?

IF YOU NEED ASSISTANCE OR SERVICE

2. If you need assistance* ...

Call Whirlpool Consumer Assistance Center telephone number. Dial toll-free from anywhere in the U.S.A.:

1-800-253-1301

and talk with one of our trained consultants. The consultant can instruct you in how to obtain satisfactory operation from your appliance or, if service is necessary, recommend a qualified service company in your area.

If you prefer, write to:

Mr. William Clark
Consumer Assistance Representative
Whirlpool Corporation
2000 M-63
Benton Harbor, MI 49022

Please include a daytime phone number in your correspondence.

3. If you need service* ...

Whirlpool has a nationwide network of authorized Whirlpool® service companies. Whirlpool service technicians are trained to fulfill the product warranty and provide after-warranty service, anywhere in the United States. To locate the authorized Whirlpool service company in your area, call our Consumer Assistance Center telephone number (see Step 2) or look in your telephone directory Yellow Pages under:

• **APPLIANCE-HOUSEHOLD-
MAJOR, SERVICE & REPAIR**

- See: Whirlpool Appliances or
Authorized Whirlpool Service
(Example: XYZ Service Co.)

• **WASHING MACHINES &
DRYERS, SERVICE & REPAIR**

- See: Whirlpool Appliances or
Authorized Whirlpool Service
(Example: XYZ Service Co.)

*When asking for help or service:

Please provide a detailed description of the problem, your appliance's complete model and serial numbers and the purchase date. (See page 2.) This information will help us respond properly to your request.

4. If you need FSP® replacement parts ...

FSP is a registered trademark of Whirlpool Corporation for quality parts. Look for this symbol of quality whenever you need a replacement part for your Whirlpool® appliance. FSP replacement parts will fit right and work right, because they are made to the same exacting specifications used to build every new Whirlpool appliance.

To locate FSP replacement parts in your area, refer to Step 3 above or call the Whirlpool Consumer Assistance Center number in Step 2.

5. If you are not satisfied with how the problem was solved ...

- Contact the Major Appliance Consumer Action Panel (MACAP). MACAP is a group of independent consumer experts that voices consumer views at the highest levels of the major appliance industry.
- Contact MACAP only when the dealer, authorized servicer and Whirlpool have failed to resolve your problem.

Major Appliance Consumer Action Panel
20 North Wacker Drive
Chicago, IL 60606

- MACAP will in turn inform us of your action.

Gearcase
assembly covered
by your warranty

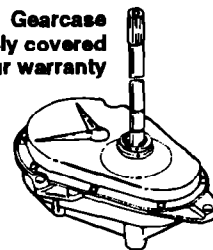

WHIRLPOOL® THIN TWIN® Washer/Dryer Warranty

LENGTH OF WARRANTY	WHIRLPOOL WILL PAY FOR
FULL ONE-YEAR WARRANTY From Date of Purchase	FSP® replacement parts and repair labor to correct defects in materials or workmanship. Service must be provided by an authorized Whirlpool service company.
LIMITED FIVE-YEAR WARRANTY From Date of Purchase	FSP replacement parts for any part of gearcase assembly if defective in materials or workmanship. The gearcase assembly is shown in the "Assistance or Service" section of this book. FSP replacement parts for any top and lid rust.
LIMITED TEN-YEAR WARRANTY From Date of Purchase	FSP replacement of outer tub should it crack, or fail to contain water, due to defective materials or workmanship.
WHIRLPOOL WILL NOT PAY FOR	
<p>A. Service calls to:</p> <ol style="list-style-type: none"> 1. Correct the installation of your washer/dryer. 2. Instruct you how to use your washer/dryer. 3. Replace house fuses or correct house wiring or plumbing. 4. Replace light bulbs. <p>B. Repairs when your washer/dryer is used in other than normal, single-family household use.</p> <p>C. Pickup and delivery. Your washer/dryer is designed to be repaired in the home.</p> <p>D. Damage to your washer/dryer caused by accident, misuse, fire, flood, acts of God or use of products not approved by Whirlpool.</p> <p>E. Any labor costs during the limited warranties.</p> <p>F. Repairs to parts or systems caused by unauthorized modifications made to the appliance.</p>	

8-92

WHIRLPOOL CORPORATION SHALL NOT BE LIABLE FOR INCIDENTAL OR CONSEQUENTIAL DAMAGES. Some states do not allow the exclusion or limitation of incidental or consequential damages, so this limitation or exclusion may not apply to you. This warranty gives you specific legal rights, and you may also have other rights which vary from state to state.

Outside the United States, a different warranty may apply. For details, please contact your authorized Whirlpool distributor or military exchange.

If you need service, first see the "Assistance or Service" section of this book. After checking "Assistance or Service," additional help can be found by calling our Consumer Assistance Center telephone number, **1-800-253-1301**, from anywhere in the U.S.