

Automatic Dishwashing Guide

363 1554595



Safety Instructions 2

0130000

What Your Dishwasher Needs 3

0582

Operating Instructions 4,5

3631554590
3631554594

Proper Loading 6,7

Special Tips 8

Dispensers 9

Important Parts of Your Dishwasher 10

Door Panels 11

User Maintenance Instructions 12

Problems and Solutions 13-15

Sears Service

Back Cover

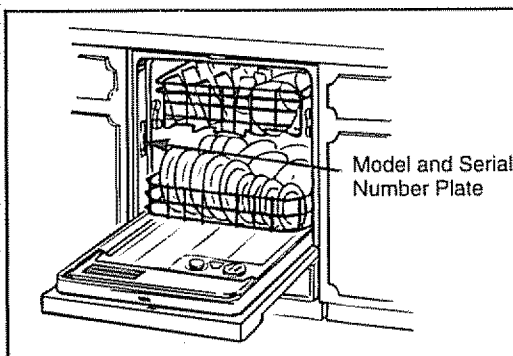

Fill in these spaces:

Model No. _____

Serial No. _____

Purchase Date _____

Important Safety Instructions

WARNING: Please follow basic precautions, including the following:



Read all instructions before using your dishwasher.



ONLY use detergents and rinse agents recommended for use in a dishwasher.

Store detergents and rinse agents in a cool, dry place **OUT OF CHILDREN'S REACH.**

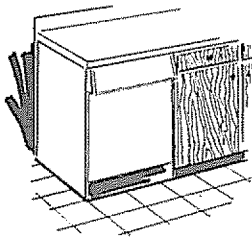

DO NOT tamper with controls.

DO NOT operate dishwasher unless all enclosure panels are properly in place.

CIRCUIT BREAKER



ALWAYS disconnect electrical power to dishwasher before attempting to service it. We recommend having a qualified technician service your appliance.

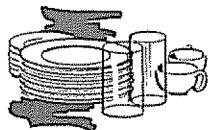

REMEMBER, use dishwasher for its intended purpose only.

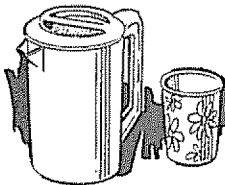

DO NOT wash plastic items unless marked "Dishwasher Safe" or equivalent. If unmarked, check manufacturer's recommendations.

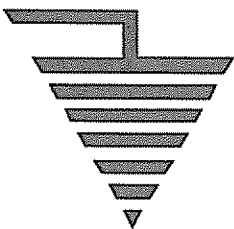

This dishwasher must be properly installed in accordance with the Installation Instructions before it is used.

TO AVOID RISK OF ELECTRICAL SHOCK, the dishwasher must be electrically grounded before it is operated.

If you did not receive an Installation Instruction booklet with your dishwasher, you can get a copy by contacting your Sears Service Center.

DO NOT touch heating element during or immediately after use. Allow time to cool.

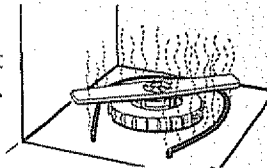

Load sharp or pointed tableware with handles up (points down) to avoid injury when reaching into dishwasher.

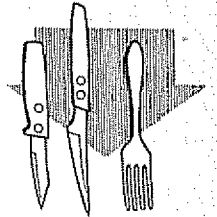

Load sharp items and knives so they aren't likely to damage door seal.

DO NOT sit or stand on or abuse dishwasher door or dishracks.



DO NOT allow children to play in or on dishwasher.

When discarding old dishwasher, BE SURE to remove door to prevent accidental entrapment.

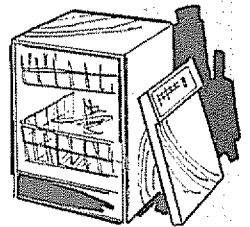

DO NOT install the dishwasher on carpeted floor.

WARNING: Under certain conditions, hydrogen gas may build up in a hot water system that has not been used for two weeks or more. **HYDROGEN GAS IS EXPLOSIVE.** To prevent injury or damage, before using dishwasher, turn on all hot water faucets and allow water to run for several minutes. This will allow gases to escape. As the gas is flammable, DO NOT smoke or use an open flame or appliance near faucets while they are open.

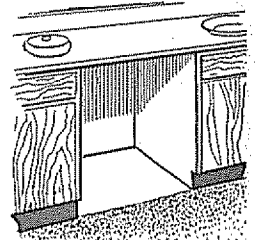

NOTE: Do not store or use combustible materials, gasoline or other flammable vapors and liquids in the vicinity of this or any other appliance.

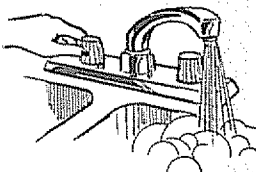

Save These Instructions

What Your Dishwasher Needs To Do Its Job

Hot Water

To get dishes clean and dry you need hot water. To help you get water of the proper temperature, your dishwasher automatically heats the water in the wash cycle. Higher water temperature is needed to dissolve grease and activate powder detergents. For good washing and drying, the entering water must be at least 120°F. To prevent dish damage, inlet water should not exceed 150°F.

- Check your water temperature with a candy or meat thermometer.
Turn on the hot water faucet nearest the dishwasher. Put the thermometer in a glass and let the water run continuously into the glass until the temperature stops rising. If the water temperature is below 120° F, adjust your water heater.
- Do not operate the dishwasher during or right after other heavy use of hot water, such as for laundry or bathing.

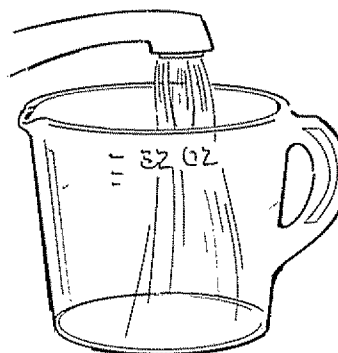

Water Pressure

Water supply pressure must be between 15 and 120 pounds per square inch. To determine if you have enough pressure, put a 1 quart container under a fully opened hot water faucet nearest the dishwasher. If the container fills in less than 9 seconds, water pressure is within an acceptable range. Be sure all other faucets are turned off during this test.

Water Conditions

In areas where water is very hard (12 grains or more), it may be necessary to install a water softener to assure proper performance from your dishwasher. If you do not know the hardness of your water supply, contact your local water department or bring a sample into your Sears store for testing.

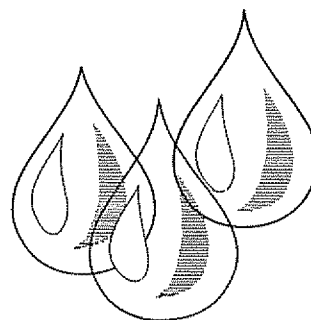

Detergents

Only use detergents labeled for use in automatic dishwashers. NEVER use laundry detergents, liquid soaps or other household cleaners in your dishwasher. Some detergents will be more effective with your water conditions than others. Store detergent in a cool, dry place.

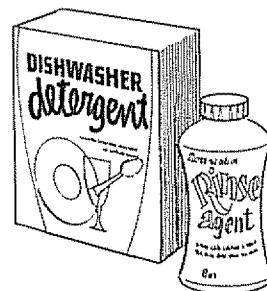

Rinse Agents

Rinse agents make water flow off dishes quicker than usual. This lessens water spotting and makes drying faster, too.

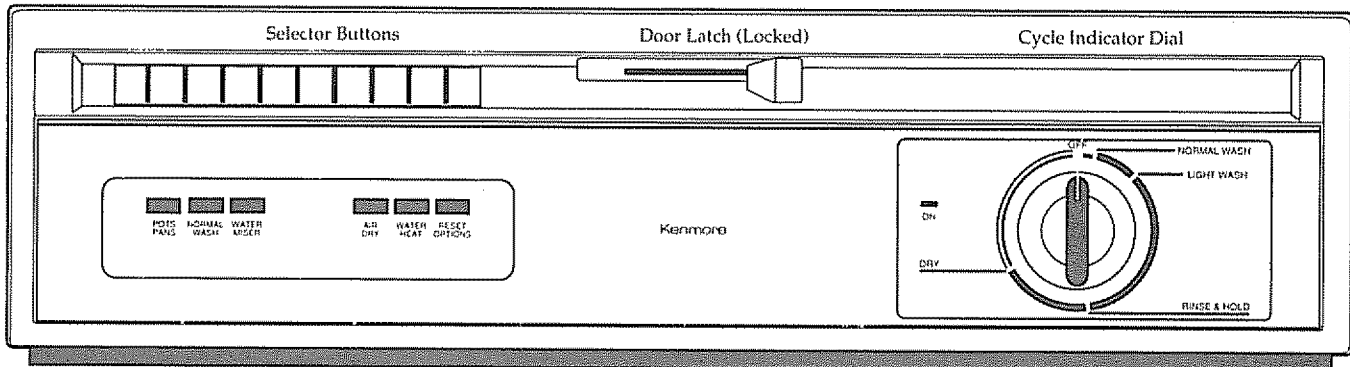

Features and appearances may vary slightly.

Starting Your Dishwasher

1. Load the dishwasher (see pages 6 and 7).
2. Add detergent (see page 9).
3. Close the door but **do not latch it**.
4. If dishwasher drains into a food waste disposer, operate disposer until it is empty.
5. Turn on hot water faucet nearest dishwasher and let it run until the water is hot.
6. Push selector buttons for desired options.
7. For all cycles but LIGHT WASH and RINSE & HOLD, slowly turn the Cycle Indicator Dial to NORMAL WASH. Then latch the door to start the dishwasher.
8. If you plan to use the LIGHT WASH or RINSE & HOLD cycle, push the NORMAL WASH button and turn the Cycle Indicator Dial to the desired option. Then latch the door to start the dishwasher.

Select the Cycle

		POTS PANS Cycle For heavily soiled dishes and pots and pans. Cycle Time: Approx. 107 minutes Water Usage: Approx. 10.6 gallons	
		NORMAL WASH Cycle For normally soiled dishes. Cycle Time: Approx. 86 minutes* Water Usage: Approx. 9.1 gallons	
		WATER MISER Cycle For tableware that is lightly soiled with fresh soils and is prerinsed. Cycle Time: Approx. 86 minutes* Water Usage: Approx. 6.4 gallons	
		LIGHT WASH Cycle For prerinsed or lightly soiled dishes and dishes that have been stored. Cycle Time: Approx. 78 minutes* Water Usage: Approx. 7.4 gallons	
		RINSE & HOLD Cycle For rinsing dishes that will be washed later. DO NOT USE DETERGENT . Cycle Time: Approx. 12 minutes Water Usage: Approx. 3.0 gallons	

Select Air-Dry
no heat drying option

*Unextended times. These cycle times will be increased approximately 21 minutes for your dishwasher to heat the water for good washability when you use the WATER HEAT button.

Select Options



AIR DRY Option

Turns heater off for entire drying period. To shorten drying time, open dishwasher door slightly.



WATER HEAT Option

Select this option and the main wash cycle is extended 21 minutes while the dishwasher heats the water for good washing and drying.

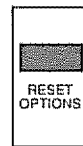

RESET OPTIONS Button

Cancels selected WATER HEAT and AIR DRY options. Main wash time will not be extended, and dishes will dry in heated air.

Normal Sights and Sounds

- You'll hear occasional sounds while your dishwasher is running:
 - Soft food disposer shredding action.
 - Drain valve opening to pump water out.
 - Timer control as cycle progresses.
 - Detergent cup opening.
 - Pump motor starting.
 - The motor stops during drying.
- You'll see water vapor coming through the vents by the door latch during drying and when water is being pumped out.

How to Add a Dish During a Cycle

- Add dishes any time during a RINSE & HOLD cycle.
- With other wash cycles, you can add dishes at any time BEFORE the main detergent wash portion of the cycle.

Here's how to add a forgotten dish:

1. Push door latch to the left. Washing will stop.
 2. Wait a few seconds until the water calms. Then open the door.
 3. Add dishes you've forgotten.
-

Energy and Water Saving Tips

- Wash full loads.
- Use your dishwasher during off-peak hours.
- Use the LIGHT WASH cycle or WATER HEAT option whenever possible.
- Select AIR DRY drying option when you don't need dry dishes in a hurry.
- Don't prerinse normally soiled dishes.
- Load correctly to ensure good washing action.

Preparing Dishes for Washing

- Prerinsing of normal food soil is not necessary.
- Scrape off bones, seeds, skins, toothpicks and other hard soils.
- Remove hard shelled vegetables, meat trimmings, leafy vegetables, and excessive amounts of oil or grease.
- Remove foods with high acid content—they can discolor stainless steel.
- Remove large quantities of *any* food.
- When using the POTS PANS cycle, less preparation is required. This cycle can wash heavily-soiled dishes and remove dried-on and baked-on soils from pots, pans and casseroles. However, items with burned-on soils may not come clean.

Proper Loading

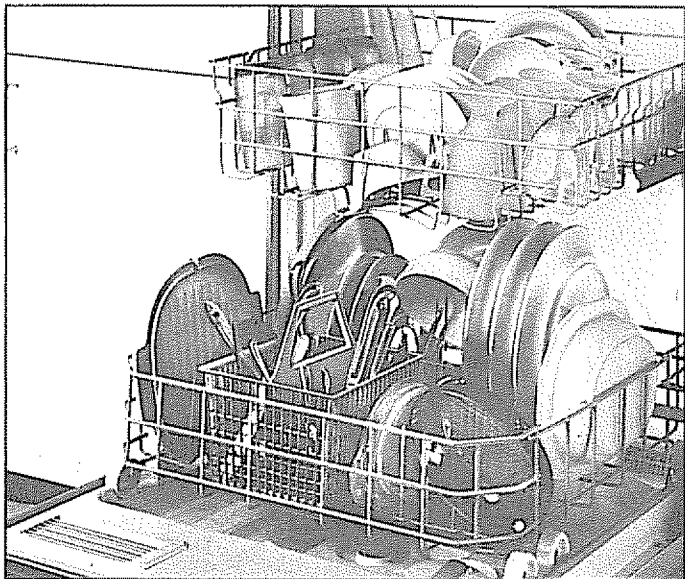

This is a random mixed load, the most common type you will have.

Make sure dishes are properly loaded to insure that water can reach the soiled surfaces. The wash arm in the bottom sprays water up. The tower that rises in the center sends water out over the dishes to wash the items in the upper rack.

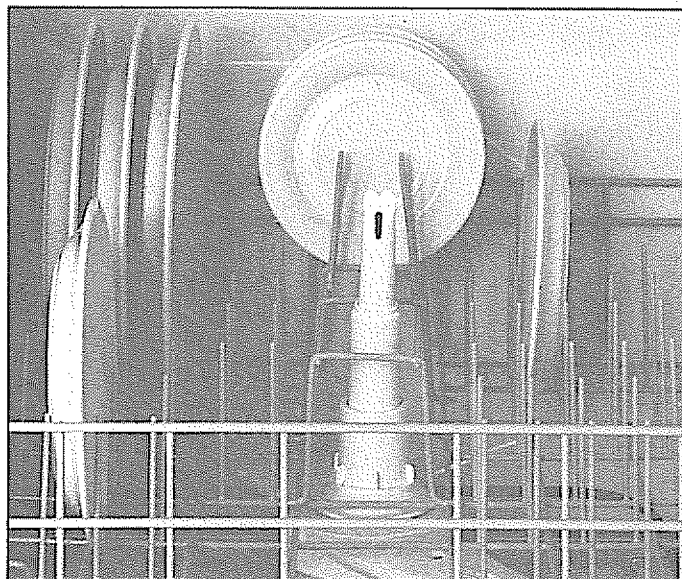

WATCH OUT FOR THIS.

The wash tower rises through the center of the bottom rack during the wash and rinse portions of the cycle. Don't block it or load tall things next to it. Also, be careful not to let a portion of an item such as a pot or dish handle extend through the bottom rack. This could block the wash arm and cause poor washing results.

Upper Rack

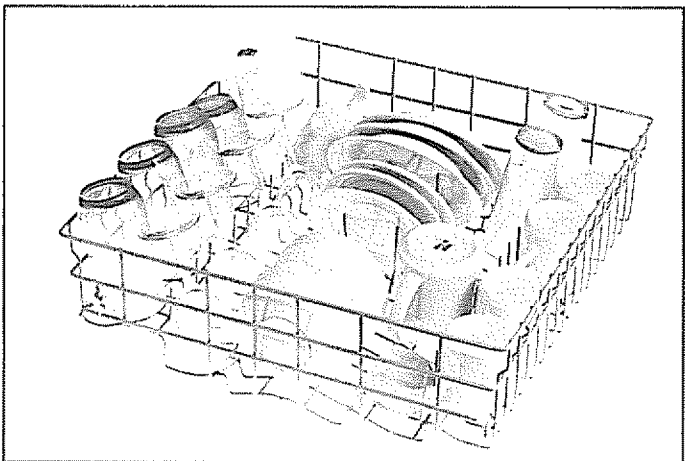

The top rack is best for glasses, cups and saucers. Cups and glasses fit best along the sides. This is the place for dishwasher-safe plastics, too. Make sure small plastic items are lodged in tightly so they can't fall onto the heating element. Arrange stemware so that it cannot move easily. Don't let the glasses touch each other.

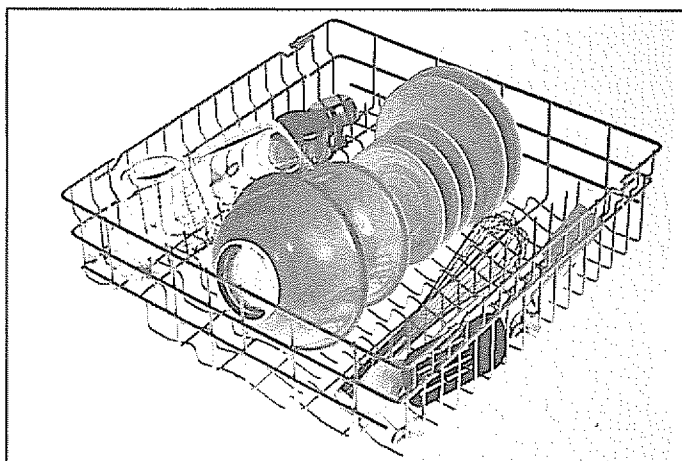

This rack is ideal for dishwasher-safe plastics. When loading, place plastic items along the back and be sure that each plastic tumbler is secured over two fingers. This will prevent dislodging; tumbler will not fall through rack onto heating unit.

Lower Rack

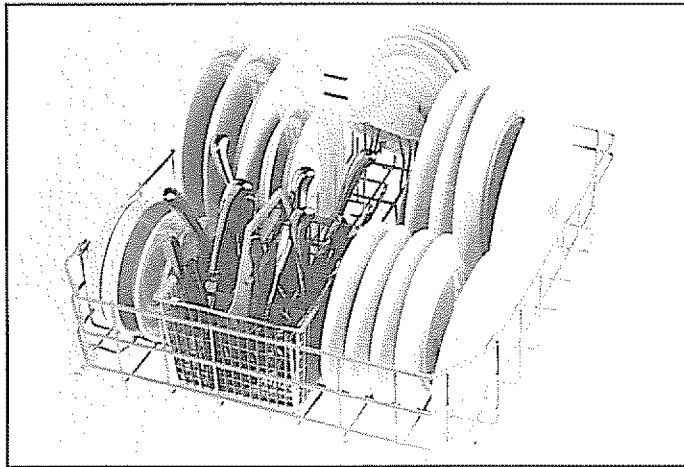

Fit plates and saucers between the pins. Place items so that water and detergent from wash arm can reach soiled surfaces.

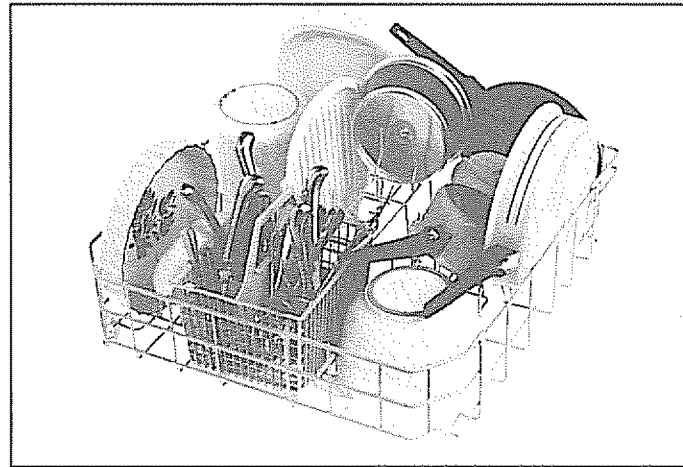

Pots, pans, casseroles, salad bowls, mixing bowls and lids *must* be loaded in the bottom rack, facing down.

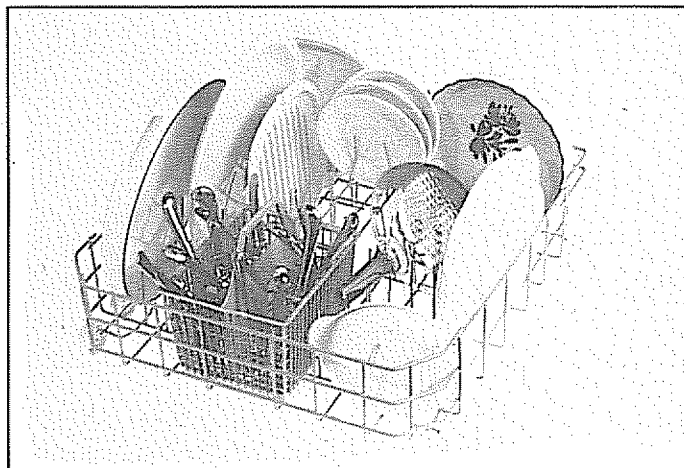

Load platters, pots, pans and bowls along the sides, in corners or in the back. All large items, such as pitchers, salad bowls, and mixing bowls, should be washed in the lower rack.

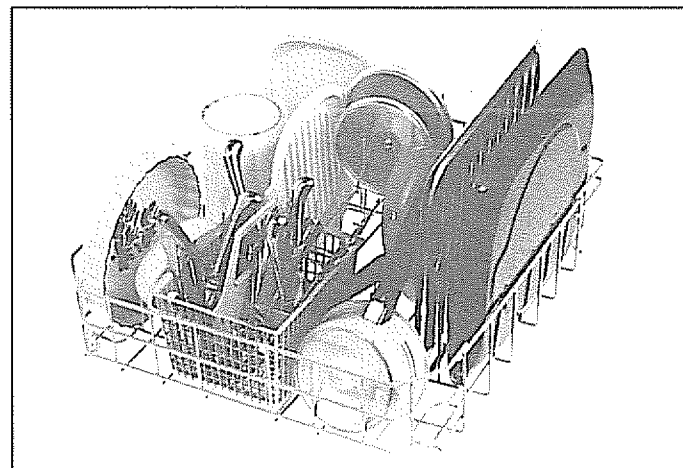

Heavily soiled pots, pans and casseroles **MUST** be loaded in the bottom rack, facing down. Prop broiler pans and racks along the edge.

Put flatware in the removable basket with handles up to protect your hands. Mix knives, forks and spoons so they don't nest together. Distribute evenly. Small plastic items, such as measuring spoons and lids from small containers are not recommended for automatic dishwashing. If placed in the dishwasher, they should go in bottom of the silverware basket with silverware on top.



Precaution!

Take out anything that may fall or extend through the bottom of the basket.



Special Tips On Dishwasher Use

Most utensils and dishware can be safely washed in your dishwasher. However, some materials may require special handling.

Aluminum: Some darkening may take place. Colored aluminum may fade. Do not place aluminum items directly in front of detergent cups where contact with undissolved detergent could cause pitting, spotting or discoloration.

Cast Iron: Cast iron utensils should be handwashed.

China: Antique, hand-painted china and those with gold or platinum rings should be handwashed.

Crystal: Load carefully in **upper rack only**. To prevent chipping, items should not touch. Handwash delicate items. Select Power Miser drying option to air-dry crystal items.

Flatware: Sterling, silverplate and stainless steel are normally dishwasher safe. Flatware with dark decorative shading and/or non-metallic handles should be handwashed.

Pewter: Pewter or pewter-like materials should be handwashed.

Plastic: Plastic items should be placed in **upper rack only**. Wash only those items marked "Dishwasher Safe."

Wood: Wood items should be handwashed.

Glass: Milk glass should be handwashed.

Non-Stick Coatings: After washing, wipe the non-stick coating area with vegetable oil to keep it from losing its non-stick quality.

Non-Dishware Items: DO NOT wash items such as electronic air cleaner filters, furnace filters and paint brushes in your dishwasher. Damage to dishwasher and discoloration or staining of dishwasher may result.

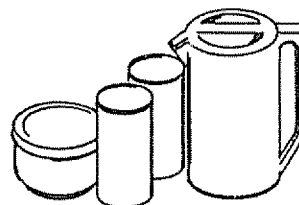
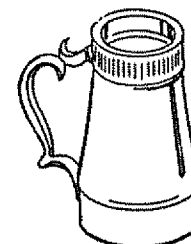
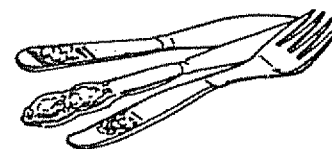
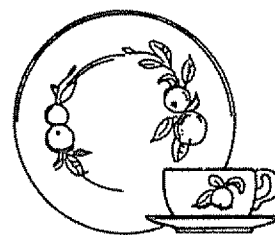
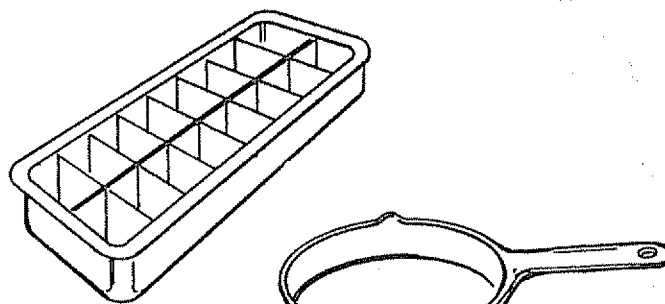

Detergent Dispenser

You'll find two detergent dispensers on the inside door of your dishwasher because some cycles use two washes.

Do not add detergent until you are ready to start the cycle. Use fresh detergent.

The dispenser will automatically release detergent at the correct times during the cycle.

Always close the main cup tightly. When it is firmly latched you will hear a clicking sound. It is not necessary to overtighten.

Close the main cup.

NOTE: To open the detergent cup after it has been closed, unlatch the door and rotate the Cycle Indicator Dial a full turn to the OFF position. When the closed cup contains soap it is best that the door be in a partially open position before rotating the Cycle Indicator Dial. This will help reduce the amount of detergent and rinse aid agent spillage into the tub.

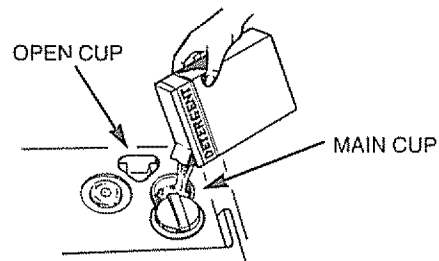

GRASP HANDLE, ROTATE AND CLOSE TIGHTLY

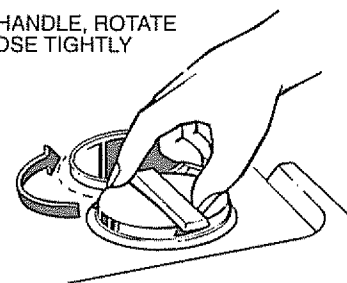

Detergent Usage Guide (powder or liquid)

Cycles	Soft Water (0 to 3 grains)	Moderately Hard Water (4 to 8 grains)	Hard Water (9 to 12 grains)	Very Hard Water (over 12 grains)
Light Wash Water Miserz	Main Cup 1 tablespoon	Main Cup Half Full	Main Cup Completely Full	Water Softener Recommended
Pots Pans Normal Wash	Each Cup 1 tablespoon	Each Cup Half Full	Each Cup Completely Full	Water Softener Recommended
Rinse & Hold	No Detergent	No Detergent	No Detergent	Water Softener Recommended

Rinse Agent Dispenser

Rinse agents come in either liquid or solid form. Your dishwasher's dispenser uses the liquid form.

To fill the dispenser:

Unscrew the cap. Note the FULL line on the tip of the cap. Add the liquid rinse agent until it just reaches the top of the FULL line. Replace the cap. The dispenser automatically releases the rinse agent into the final rinse water.

Fill as needed, but do not overfill.

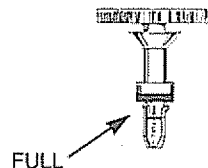

Important Parts of Your Dishwasher

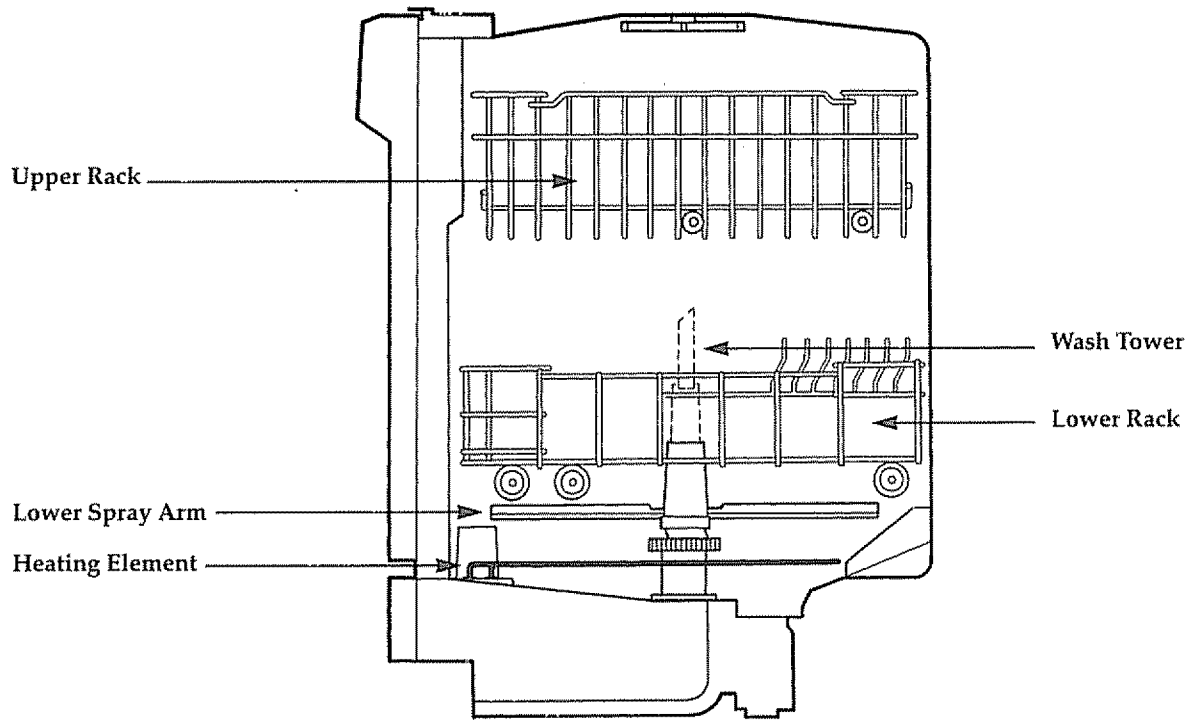

Right Side View

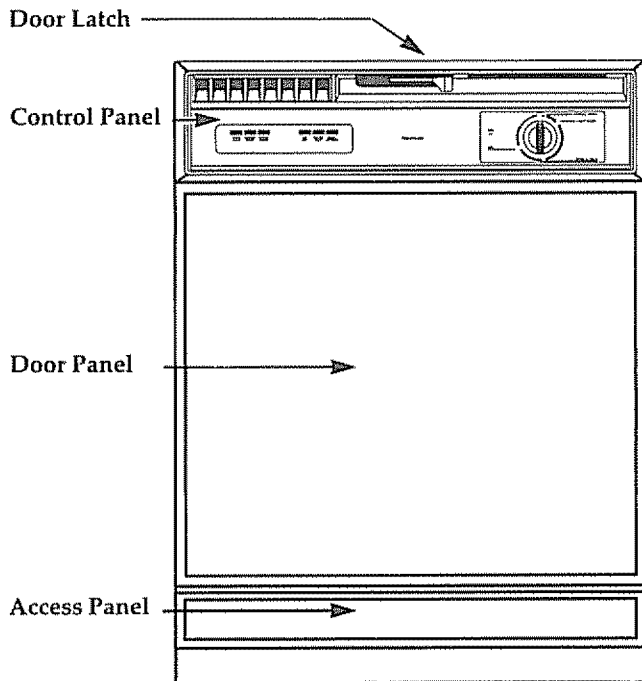

Front View

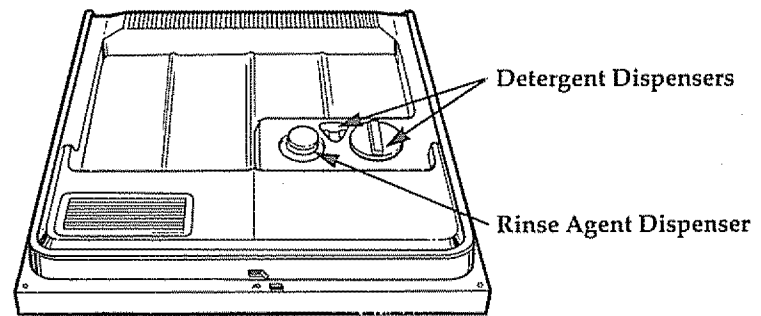

Inner Door

Changing Color Panel

If you are redecorating, you can change your dishwasher's front panel to match or blend with your new colors.

The panel is held in place by the door trim and the trim on the panel below the door. Each side of each panel is a different color. Or you can paint the panel with the color of your own choice.

WARNING: To prevent electric shock, disconnect electrical power supply to dishwasher before changing panels.

How to change the door panel:

1. Take out trim screws on either side of dishwasher door. Remove side trim.
2. Slide out the door panel. (Careful—edges may be sharp.)
3. Turn the door panel around and put the color you want in front.
4. Replace the door panel, side trim and screws.

How to change the lower panel:

1. Remove the bottom panel attachment screws.
2. On models without top mounting screws, remove the entire access assembly by lifting it up and over the retaining tabs.
3. On models with top mounting screws, remove the screws.
4. Take out the top trim screws and remove the top trim.
5. Slide the color panel(s) up and out and put the color you want in front.
6. Replace the top trim and screws.
7. Replace the entire access assembly by reversing the steps.

Do not operate dishwasher while changing panels or when lower access panel is removed.

Wood panel trim kits contain trim and instructions for adding a decorative wood door panel and lower access panel no thicker than 1/4" to match kitchen cabinets. This kit is available at no extra cost.

Specify the trim color of your choice from the following options:

- GPF40BC (Chrome Trim and Screws)
- GPF40BK (Black Trim)
- GPF40WH (White Trim)

Order from:

Dri-View Manufacturing
4706 Allmond Ave.
Louisville, KY 40209

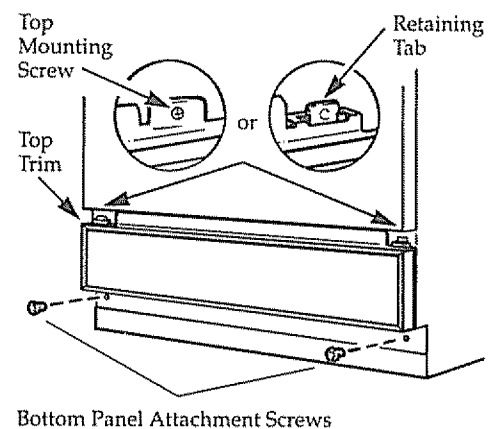
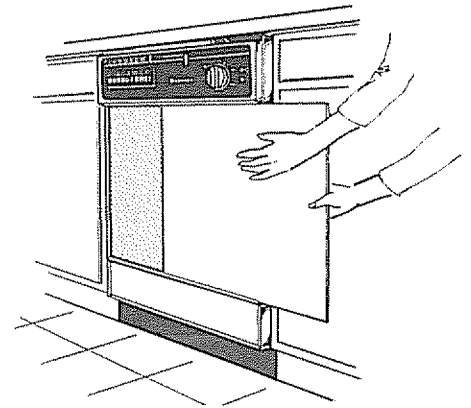

User Maintenance Instructions

Care of Surfaces

- Clean control panel with lightly dampened cloth. Dry thoroughly. Do not use abrasives or sharp objects—they could damage it.
- Clean outside cabinet finish with a good appliance polish wax. Do not use scouring pads, harsh or gritty cleaners.
- Interior is self-cleaning with normal use. If it should ever need cleaning, use a mild cleansing powder. If hard water causes lime build-up, clean as follows:
 - Pour 2 cups white vinegar into empty dishwasher. Do not use detergent.
 - Operate machine on Normal Wash cycle.

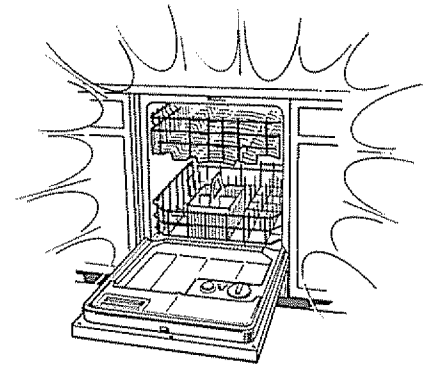

Care of Air Gap

If an air gap was installed for your built-in dishwasher, check to make sure it is clean. Air gaps are usually mounted on the countertop and can be inspected by removing the cover. **The air gap is not part of your dishwasher and is not covered by Sears warranty.**

Drain Air Gap

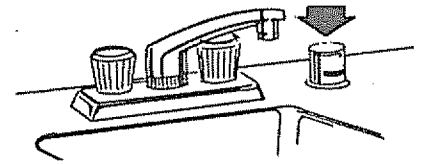

Protection against Freezing

If dishwasher is left in an unheated place during the winter...

- Shut off water and electrical power.
- Remove access panel.
- Disconnect water lines from valve. Drain into a flat pan.
- Drain collection chamber at rear of unit below filter by disconnecting hose to pump.
- Remove plastic pump cover in tub bottom and use sponge to soak up any remaining water.
- Reconnect water lines to valve and hoses to pump.

Pump Cover
Screws

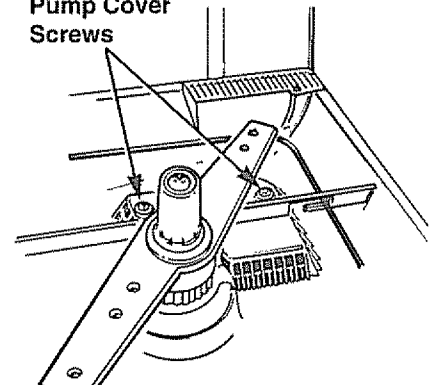

Preparation for Moving

- Disconnect electrical power.
- Turn off water supply, disconnect water and drain lines.
- Tape racks in place; close door securely and tape it shut.
- Wrap with blankets, and if using a hand truck, lift dishwasher from side in upright position only.

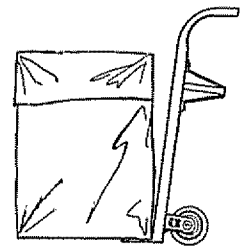

Common Dishwashing Problems and Solutions

Problem	Caused by	Solution
Dishwasher will not start	Dishwasher not receiving electricity	Check house fuse or circuit breaker.
	Dial not in correct position for cycle selected	Make sure dial is turned far enough and cycle button is fully pushed in.
Dishwasher will not fill with water	No water supply	Make sure water supply valve under sink is turned on.
	Water inlet valve clogged	Water valve supply line may be clogged with sediment. Clean out
Unusual noise	Improper loading	Utensils may not be secure on rack pins, or something small may have dropped from the rack. Water is causing utensils to rattle. Make sure everything is securely placed in dishwasher.
Dishwasher leaks	Dishwasher not level	Level dishwasher as described in Installation Instructions. Do not place dishwasher on carpet.
	Too much sudsing	Improper detergent. Use automatic dishwasher detergent only or try a different brand or less detergent. If hand dishwashing detergent is used by mistake, pour one measuring cup of vegetable oil in bottom of tub and run dishwasher through a complete NORMAL WASH cycle with recommended amount of automatic dishwashing detergent. To remove suds from tub: Open dishwasher. Let suds evaporate. Add 1 gallon of cold water to tub. Close and latch dishwasher. Pump out water by slowly turning control dial until a drain period is reached. Repeat if necessary.
	Spilled rinse agent	Spilled rinse agent can cause foam during washing. This can lead to overflowing. Wipe up accidental spill of rinse agent with a damp cloth.
Detergent cup lid won't latch after adding detergent	Cycle Indicator dial not in OFF position	Cycle Indicator dial must be in OFF position for cup lid to close and latch properly. If you unlatch the door and open it to dry your dishes, the Cycle Indicator dial does not advance to OFF by itself.
Dishes not dry	Water is not hot	Raise water heater thermostat to 140°F. if necessary.
	AIR DRY option selected	Do not select AIR DRY drying option. Allow dishes to dry in heated air.
	Improper loading	Load dishes so items drain properly. Avoid overloading.
	Rinse agent dispenser empty	Fill rinse agent dispenser if empty.

(continued next page)

Common Dishwashing Problems and Solutions (continued)

Problem	Caused by	Solution
Spotting and filming	Hard water	Fill detergent cups to capacity. Use dishwasher detergent with highest available phosphorous content. May be necessary to install a water softener.
	Water is not hot	Raise water heater thermostat to 140°F.
	AIR DRY drying option selected	Drying without heat may cause some spotting. Do not select AIR DRY option.
	Not enough or poor quality detergent	Use more fresh automatic dishwasher detergent. Use detergent with highest available phosphorous content, especially if you have hard water.
	Old detergent	Use only fresh, automatic dishwasher detergent. Store tightly closed in a cool dry place. Discard old, lumpy or separated detergent. Do not fill detergent cups until ready to wash.
	No rinse agent	Fill rinse agent dispenser. To remove stubborn spots and film from glassware: <ol style="list-style-type: none"> 1. Remove all metal utensils from the dishwasher. 2. Do not add detergent. 3. Select POTS PANS cycle. 4. Start the dishwasher and allow to run for 18 to 20 minutes. The dishwasher will now be in the main wash. 5. Then open the door and pour 2 cups (500ml) white vinegar into bottom of dishwasher. 6. Close the door and allow to complete the cycle. If vinegar rinse doesn't work: Repeat as above, except use 1/4 cup (60ml) of citric acid crystals instead of vinegar. (Most drugstores carry citric acid crystals.)
Etching—permanent filming which cannot be removed	Too much detergent in soft water	Reduce amount of dishwasher detergent. Use detergent with lower phosphorous content.
	Improper loading	Make sure dishes and glassware are loaded properly to permit water spray to rinse all surfaces. Do not overload.
Water left in bottom of tub	Normal amount of water	It is normal for a small amount of clean water to remain in bottom of tub after each cycle.
	Drain air gap	Clean the drain air gap. See User Maintenance Instructions.

Problem	Caused by	Solution
Dishes and interior of dishwasher brown or yellow	Iron or manganese in water	Install an iron or manganese filter in home water supply.
Film build-up on lower front of tub	Some detergent did not dissolve	Use fresh, automatic dishwasher detergent. Use detergent with highest available phosphorous content, especially if you have hard water. Raise water heater thermostat to 140°F. if necessary. Run water at sink until hot before starting dishwasher. Remove film with dishwashing detergent and warm water.
Silverware stained	Undissolved detergent contacting wet silverware Acidic or salty food soils	Avoid spilling dry detergent on wet silverware. Clean with silver polish. Use RINSE & HOLD cycle. Certain foods left on silverware for extended periods of time may cause pitting
Bronze tarnish on silver plate	Silver plate worn off exposing base metal—takes on bronze hue	Remove tarnish with silver polish. Replace silver.
Black or gray marks on dish	Metal utensils rubbing against dishes during wash	Load metal utensils so they do not rub against dishes. Marks may be removed with mild abrasive cleanser and plastic scouring pad.
Dishware chipped or broken	Improper loading	Do not overload. Load glasses in upper rack only. See Proper Loading section for tips.
Dishwasher odor	Soiled dishes held too long in dishwasher Vinyl rack coating	Use RINSE & HOLD cycle if dishes will not be washed at end of day. Plastic odor will be gone after several weeks use.
Motor Hums	Dishwasher has not been used on a regular basis	If you do not use your dishwasher often set it to fill and pump out, once every week. This will help keep the seal moist and the garbage disposer clear.
Staining of tub interior	Some detergents contain colorant (pigment or dyes)	This will discolor the tub interior with extended use. Check the detergent cup for signs of any discoloration. If cup is discolored, change to detergent without any colorant.

We Service What We Sell

"We Service What We Sell" is our assurance you can depend on Sears for service. . . and Sears service is nationwide. Your dishwasher has added value when you consider that Sears has service units nationwide, staffed with professional technicians specifically trained on Sears appliances and having parts, tools and equipment to insure that we meet our pledge to you. . . "We Service What We Sell."

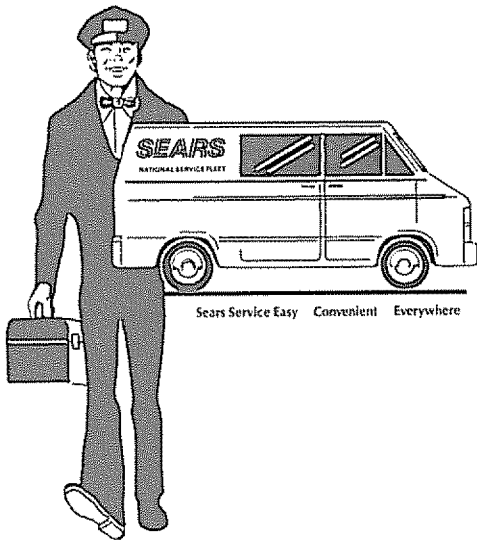

Sears Maintenance Agreement

Maintain the value of your Kenmore dishwasher with a Sears Maintenance Agreement. Sears dishwashers are designed, manufactured, and tested for years of dependable operation. Yet, any modern appliance may require service from time to time.

The Sears Maintenance Agreement

- Is your way to buy tomorrow's service at today's price.
- Eliminates repair bills resulting from normal use.
- Allows for as many service calls as required.
- Provides for service by professional Sears-trained technicians.
- Offers an annual preventive maintenance check-up at your request.

This maintenance agreement does not cover original installation, reinstallation, or damage resulting from external causes such as acts of abuse, theft, fire, flood, wind, lightning, freezing, power failure, power reduction, etc.

Sears Dishwasher Warranty

Full One-Year Warranty on Dishwasher

For one year from the first day of use in your home, Sears will repair, free of charge, defects in material or workmanship which appear in this dishwasher.

Full Ten-Year Warranty Against Leaks in the Tub and Inner Door Panel

For ten years from the first day of use in your home, if a leak should occur as a result of failure of the tub or inner door panel due to cracking, chipping, or peeling, Sears will replace, free of charge, the tub or inner door panel.

If the dishwasher is subjected to other than private family use, the above warranty coverage is effective for only 90 days.

Warranty service is available by contacting the NEAREST SEARS SERVICE CENTER/DEPARTMENT in the United States. This warranty applies only while this product is in use in the United States.

This warranty gives you specific legal rights, and you may also have other rights which vary from state to state.

SEARS, ROEBUCK AND CO., Dept. 731CR-W, Sears Tower, Chicago, IL 60684

Part No. SR5530

Printed in U.S.A.
165D3592P031

15545
16541
16545