



ULTRA WAVE™ Microwave Hood Combination

Use & Care Guide

Combinación Microondas Campana de ULTRA WAVE™

Guía de uso y cuidado

Models/Modelos 721.80862 / 721.80863
 721.80864 / 721.80869



P/N:3828W5A4220

ENGLISH

ESPAÑOL

Table of Contents

| | |
|---|------------|
| Warranty | 2 |
| Sears Service | 3 |
| Microwave Oven Safety | 4 |
| Getting to Know Your Microwave Oven | 7 |
| How your kenmore ULTRA WAVE™ microwave hood combination works | 7 |
| Radio interference | 7 |
| Testing your microwave oven | 8 |
| Testing your dinnerware or cookware | 8 |
| Operating safety precautions | 8 |
| Electrical connection | 8 |
| Microwave oven features | 9 |
| Control panel features..... | 10 |
| Using Your Microwave Oven | 12 |
| Audible Signals | 12 |
| Interrupting Cooking..... | 12 |
| Clock..... | 12 |
| Child Lock | 12 |
| Timer..... | 13 |
| Cooktop Light..... | 14 |
| Exhaust Fan..... | 14 |
| Add Minute..... | 14 |
| Timed Cooking..... | 15 |
| Multi-stage Cooking | 15 |
| Microwave Power Levels | 16 |
| Auto Defrost..... | 17 |
| Auto defrost table..... | 18 |
| Auto defrost table (Cont.)..... | 19 |
| Defrosting tips | 20 |
| Hold Warm | 20 |
| Sure Simmer..... | 21 |
| Using Sensor Cooking..... | 22 |
| Sensor Cooking | 22 |
| Potato (Example)..... | 22 |
| More/Less | 22 |
| Sensor Cooking Table | 23 |
| Auto Cook, Auto Reheat | 24 |
| Auto Cook Table, Auto Reheat Table | 25 |
| Soften, Soften Table | 26 |
| Melt, Melt Table | 26 |
| Caring for Your Microwave Oven | 27 |
| Caring for the filters..... | 28 |
| Replacing the cooktop and oven lights | 29 |
| Microwave Cooking Tips..... | 31 |
| Questions and Answers | 33 |
| Troubleshooting..... | 34 |
| Service | Back cover |

Microwave Hood Combination Warranty

FULL ONE-YEAR WARRANTY ON MICROWAVE HOOD COMBINATION

For one year from the date of purchase, if this Kenmore Microwave Hood Combination fails due to a defect in material or workmanship, Sears will repair it free of charge.

FULL FIVE-YEAR WARRANTY ON THE MAGNETRON

For five years from the date of purchase, if the magnetron in this Kenmore Microwave Hood Combination fails due to a defect in material or workmanship, Sears will repair it free of charge.

The above warranty coverage applies only to Microwave Hood Combinations which are used for private household purposes.

WARRANTY SERVICE IS AVAILABLE BY SIMPLY CONTACTING SEARS SERVICE AT 1-800-4-MY-HOME®

This warranty applies only while this product is in use in the United States.

This warranty gives you specific legal rights, and you may also have other rights which vary from state to state.

**Sears, Roebuck and Co.,
Dept. 817WA,
Hoffman Estates, IL 60179**

**For service call:
1-800-4-MY-HOME®
(1-800-469-4663)**

Please record your model's information.

Whenever you call to request service for your appliance, you need to know your complete model number and serial number. You can find this information on the model and serial number label/plate at the upper side of cavity front in your Microwave oven. Also, record the other information shown below.

Model Number _____
Serial Number _____
Purchase Date _____

Sears Service

Master Protection Agreements

Congratulations on making a smart purchase.

Your new Kenmore® product is designed and manufactured for years of dependable operation. But like all products, it may require preventive maintenance or repair from time to time. That's when having a Master Protection Agreement can save you money and aggravation.

Purchase a Master Protection Agreement now and protect yourself from unexpected hassle and expense.

The Master Protection Agreement also helps extend the life of your new product. Here's what's included in the Agreement:

- ☑ **Expert service** by our 12,000 professional repair specialists
- ☑ **Unlimited service and no charge** for parts and labor on all covered repairs
- ☑ **“No-lemon” guarantee** – replacement of your covered product if four or more product failures occur within twelve months
- ☑ **Product replacement** if your covered product can't be fixed
- ☑ **Annual Preventive Maintenance Check** at your request – no extra charge
- ☑ **Fast help by phone** – phone support from a Sears technician on products requiring in-home repair, plus convenient repair scheduling
- ☑ **Power surge protection** against electrical damage due to power fluctuations
- ☑ **Rental reimbursement** if repair of your covered product takes longer than promised

Once you purchase the Agreement, a simple phone call is all that it takes for you to schedule service. You can call anytime day or night, or schedule a service appointment online.

Sears has over 12,000 professional repair specialists, who have access to over 4.5 million quality parts and accessories. That's the kind of professionalism you can count on to help prolong the life of your new purchase for years to come. Purchase your Master Protection Agreement today!

Some limitations and exclusions apply. For prices and additional information call 1-800-827-6655.

Sears Installation Service

For Sears professional installation of home appliances, garage door openers, water heaters, and other major home items, in the U.S.A. call **1-800-4-MY-HOME®**

Microwave Oven Safety

Your safety and the safety of others are very important.

We have provided many important safety messages in this manual and on your appliance. Always read and obey all safety messages.



This is the safety alert symbol.

This symbol alerts you to hazards that can kill or hurt you and others.

All safety messages will be preceded by the safety alert symbol and the word “DANGER” or “WARNING.” These words mean:

⚠ DANGER

You will be killed or seriously injured if you don't follow immediately instructions.

⚠ WARNING

You can be killed or seriously injured if you don't follow instructions.

All safety messages will identify the hazard, tell you how to reduce the chance of injury, and tell you what can happen if the instructions are not followed.

IMPORTANT SAFETY INSTRUCTIONS

When using electrical appliances basic safety precautions should be followed, including the following:

WARNING: To reduce the risk of burns, electric shock, fire, injury to persons, or exposure to excessive microwave energy:

- Read all instructions before using the microwave oven.
- Read and follow the specific “PRECAUTIONS TO AVOID POSSIBLE EXPOSURE TO EXCESSIVE MICROWAVE ENERGY” found in this section.
- The microwave oven must be grounded. Connect only to properly grounded outlet. See “GROUNDING INSTRUCTIONS” found at the end of this section.
- Install or locate the microwave oven only in accordance with the provided installation instructions.
- Some products such as whole eggs in the shell and sealed containers – for example, closed glass jars – are able to explode and should not be heated in the microwave oven.
- Use the microwave oven only for its intended use as described in this manual. Do not use corrosive chemicals or vapors in the microwave oven. This type of oven is specifically designed to heat, cook, or dry food. It is not designed for industrial or laboratory use.
- As with any appliance, close supervision is necessary when used by children.
- Do not operate the microwave oven if it has a damaged cord or plug, if it is not working properly, or if it has been damaged or dropped.

SAVE THESE INSTRUCTIONS

IMPORTANT SAFETY INSTRUCTIONS

- The microwave oven should be serviced only by qualified service personnel. Call an authorized service company for examination, repair, or adjustment.
- See door surface cleaning instructions in the “Caring for Your Microwave Oven” section.
- To reduce the risk of fire in the oven cavity:
 - Do not overcook food. Carefully attend the microwave oven when paper, plastic, or other combustible materials are placed inside the oven to facilitate cooking.
 - Remove wire twist-ties from paper or plastic bags before placing bags in oven.
 - If materials inside the oven ignite, keep oven door closed, turn oven off, and disconnect the power cord, or shut off power at the fuse or circuit breaker panel.
 - Do not use the cavity for storage purposes. Do not leave paper products, cooking utensils, or food in the cavity when not in use.
- Suitable for use above both gas and electric cooking equipment.
- Intended to be used above ranges with maximum width of 36 inches (91 cm).
- Clean Ventilating Hoods Frequently - Grease should not be allowed to accumulate on hood or filter.
- When flaming foods under the hood, turn the fan on.
- Use care when cleaning the vent-hood filter. Corrosive cleaning agents, such as lye-based oven cleaners, may damage the filter.
- Oversized foods or oversized metal utensils should not be inserted in the microwave oven as they may create a fire or risk of electric shock.
- Do not clean with metal scouring pads. Pieces can burn off the pad and touch electrical parts involving a risk of electric shock.
- Do not store anything directly on top of the microwave oven when the microwave oven is in operation.
- Do not cover or block any openings on the microwave oven.
- Do not store this microwave oven outdoors. Do not use the microwave oven near water for example, near a kitchen sink, in a wet basement, near a swimming pool, or similar location.
- Do not immerse cord or plug in water.
- Keep cord away from heated surfaces.
- Do not let cord hang over edge of table or counter.
- Do not mount over a sink.
- Do not cover racks or any other part of the oven with metal foil. This will cause overheating of the oven.
- Liquids such as water, coffee, or tea are able to be overheated beyond the boiling point without appearing to be boiling due to surface tension of the liquid. Visible bubbling or boiling when the container is removed from the microwave oven is not always present. This could result in very hot liquids suddenly boiling over when a spoon or other utensil is inserted into the liquid. To reduce the risk of injury to persons.
 - 1) Do not overheat the liquid.
 - 2) Stir the liquid both before and halfway through heating it.
 - 3) Do not use straight-sided containers with narrow necks.
 - 4) After heating, allow the container to stand in the microwave oven for a short time before removing the container.
 - 5) Use extreme care when inserting a spoon or other utensil into the container.

SAVE THESE INSTRUCTIONS

PRECAUTIONS TO AVOID POSSIBLE EXPOSURE TO EXCESSIVE MICROWAVE ENERGY

- (a) Do not attempt to operate this oven with the door open since open - door operation can result in harmful exposure to microwave energy. It is important not to defeat or tamper with the safety interlocks.
- (b) Do not place any object between the oven front face and the door or allow soil or cleaner residue to accumulate on sealing surfaces.
- (c) Do not operate the oven if it is damaged. It is particularly important that the oven door close properly and that there is no damage to the:
 - (1) Door (bent),
 - (2) Hinges and latches (broken or loosened),
 - (3) Door seals and sealing surfaces.
- (d) The oven should not be adjusted or repaired by anyone except properly qualified service personnel.

ENGLISH

Electrical requirements

Observe all governing codes and ordinances. A 120 Volt, 60 Hz, AC only, 20 amp fused electrical supply is required. (A time-delay fuse is recommended.) It is recommended that a separate circuit serving only this appliance be provided.

DANGER



Electrical Shock Hazard
 Plug into a grounded 3-prong outlet. Do not remove ground prong. Do not use an adapter. Do not use an extension cord. Failure to follow these instructions can result in death, fire, or electrical shock.

GROUNDING INSTRUCTIONS

• **For all cord connected appliances:**
 The microwave oven must be grounded. In the event of an electrical short circuit, grounding reduces the risk of electric shock by providing an escape wire for the electric current. The microwave oven is equipped with a cord having a grounding wire with a grounding plug. The plug must be plugged into an outlet that is properly installed and grounded.

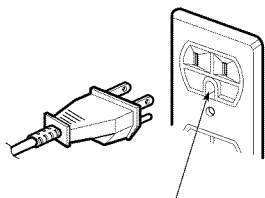

Ensure proper ground exists before use

WARNING: Improper use of the grounding can result in a risk of electric shock.

Consult a qualified electrician or serviceman if the grounding instructions are not completely understood, or if doubt exists as to whether the microwave oven is properly grounded. Do not use an extension cord. If the power supply cord is too short, have a qualified electrician or serviceman install an outlet near the microwave oven.

• **For a permanently connected appliance:**
 The microwave oven must be connected to a grounded, metallic, permanent wiring system, or an equipment grounding conductor should be run with the circuit conductors and connected to the equipment grounding terminal or lead on the microwave oven.

SAVE THESE INSTRUCTIONS

Getting to Know Your Microwave Oven

This section discusses the concepts behind microwave cooking. It also shows you the basics you need to know to operate your microwave oven. Please read this information before you use your oven.

HOW YOUR KENMORE ULTRA WAVE™ MICROWAVE HOOD COMBINATION WORKS

Microwave energy is not hot. It causes food to make its own heat, and it's this heat that cooks the food. Microwaves are like TV waves, radio waves, or light waves. You cannot see them, but you can see what they do.

A **magnetron** in the microwave oven produces microwaves. The microwaves move into the oven where they contact food as it turns on the turntable.

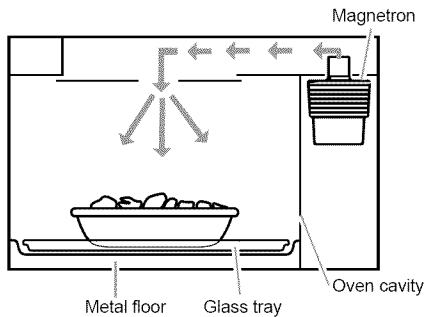

The **glass turntable** of your microwave oven lets microwaves pass through. Then they bounce off a metal floor, back through the glass turntable, and are absorbed by the food.

Microwaves pass through most glass, paper, and plastics without heating them so food absorbs the energy. Microwaves bounce off metal containers so food does not absorb the energy.

ULTRA WAVE™ Inverter Microwave System

ULTRA WAVE™ Inverter Microwave System gives you better microwave cooking performance for defrosting, cooking and reheating foods quickly and uniformly.

The ULTRA WAVE™ Inverter Microwave System is proven technology that delivers a constant stream of microwave power - true high, medium, and low power.

Conventional microwave ovens operate on HIGH power only. To achieve a 70% power level in a conventional microwave oven, the oven operates 70% of the time at HIGH power and 30% of the time OFF.

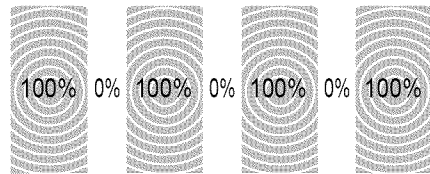

The ULTRA WAVE™ Inverter Microwave System delivers power continuously, to defrost more evenly and minimize overcooking of food and messy food spatters.



Sensor Cooking

The ULTRA WAVE™ Inverter Microwave System features Sensor Cooking functions. A humidity sensor in the oven cavity detects moisture and humidity emitted from food as it heats. The sensor adjusts cooking times to various types and amounts of food. Sensor cooking takes the guesswork out of microwave cooking.

For the best cooking results

- **Always cook food** for the shortest cooking time recommended. Check to see how the food is cooking.
- **Stir, turn over, or rearrange** the food being cooked about halfway through the cooking time for all recipes. This will help make sure the food is evenly cooked.
- **If you do not have a cover for a dish**, use wax paper, or microwave-approved paper towels or plastic wrap. Remember to turn back a corner of the plastic wrap to vent steam during cooking.

Radio interference

Using your microwave oven may cause interference to your radio, TV, or similar equipment. When there is interference, you can reduce it or remove it by:

- **Cleaning** the door and sealing surfaces of the oven.
- **Adjusting** the receiving antenna of the radio or television.

- **Moving** the receiver away from the microwave oven.
- **Plugging** the microwave oven into a different outlet so that the microwave oven and receiver are on different branch circuits.

Testing your microwave oven

To test the oven put about 1 cup of cold water in a glass container in the oven. Close the door.

Make sure it latches. Cook at 100% power for 1 minute. When the time is up, the water should be heated.

Testing your dinnerware or cookware

Test dinnerware or cookware before using. To test a dish for safe use, put it into the oven with a cup of water beside it. Cook at 100% cook power for one minute. **If the dish gets hot, do not use it.** Some dishes (melamine, some ceramic dinnerware, etc.) absorb microwave energy,

becoming too hot to handle and slowing cooking times. Cooking in metal containers not designed for microwave use could damage the oven, as could containers with hidden metal (twist-ties, foil lining, staples, metallic glaze or trim).

Operating safety precautions

- **Never** lean on the door or allow a child to swing on it when the door is open.
- **Use hot pads.** Microwave energy does not heat containers, but the heat from the food can make the container hot.
- **Do not** use newspaper or other printed paper in the oven.
- **Do not** dry flowers, fruit, herbs, wood, paper, gourds, or clothes in the oven.
- **Do not** start a microwave oven when it is empty. Product life may be shortened. If you practice programming the oven, **put** a container of water in the oven. It is normal for the oven door to look wavy after the oven has been running for a while.
- **Do not** try to melt paraffin wax in the oven. Paraffin wax will not melt in a microwave oven because it allows microwaves to pass through it.
- **Do not** operate the microwave oven unless the glass turntable is securely in place and can move freely. The turntable can move in either direction. **Make sure** the turntable is correct-side up in the oven. **Handle your turntable with care** when removing it from the oven to avoid possibly breaking it. If your turntable cracks or breaks, contact your dealer for a replacement.
- **When you use a browning dish,** the browning dish bottom must be at least 3/16 inch above the turntable. Follow the directions supplied with the browning dish.
- **Never cook or reheat a whole egg inside the shell.** Steam buildup in whole eggs may cause them to burst, and possibly damage the oven.
- **Slice** hard-boiled eggs before heating. In rare cases, poached eggs have been known to explode. **Cover** poached eggs and **allow** a standing time of one minute before cutting into them.
- **For best results, stir any liquid several times during heating or reheating.** Liquids heated in certain containers (especially containers shaped like cylinders) may become overheated. The liquid may splash out with a loud noise during or after heating or when adding ingredients (coffee granules, tea bags, etc.). This can harm the oven.
- **Microwaves** may not reach the center of a roast. The heat spreads to the center from the outer, cooked areas just as in regular oven cooking. This is one of the reasons for letting some foods (for example, roasts or baked potatoes) stand for a while after cooking, or for stirring some foods during the cooking time.
- **Do not deep fry in the oven.** Microwavable utensils are not suitable and it is difficult to maintain appropriate deep-frying temperatures.
- **Do not overcook potatoes.** At the end of the recommended cooking time, potatoes should be slightly firm because they will continue cooking during standing time. **After microwaving, let** potatoes stand for 5 minutes. They will finish cooking while standing.

Electrical connection

If your electric power line or outlet voltage is less than 110 volts, cooking times may be longer.

Have a qualified electrician check your electrical system.

Microwave oven features

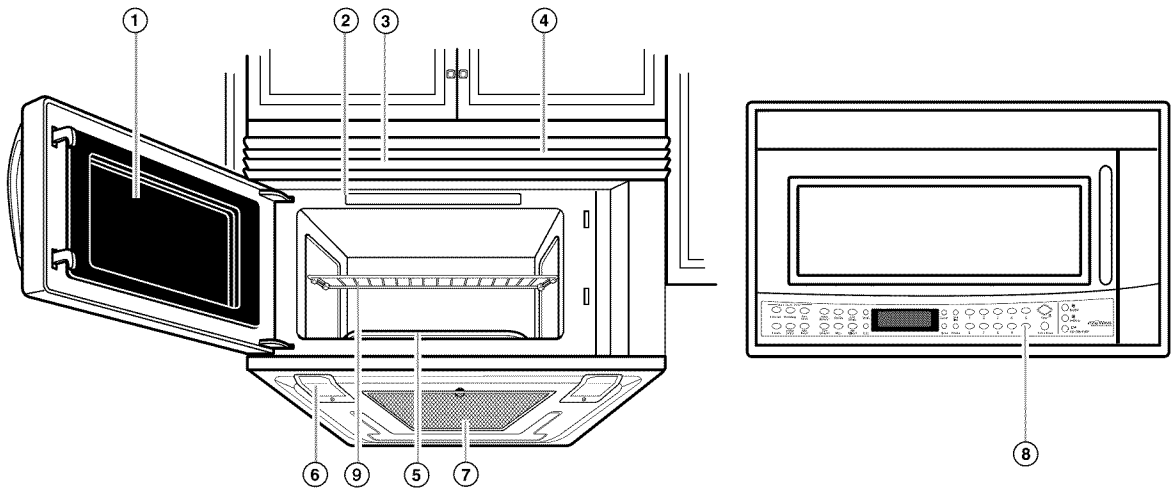

Your microwave oven is designed to make your cooking experience as enjoyable and productive as possible. To get you up and running quickly, the following is a list of the oven's basic features:

- 1. Metal Shielded Window.** The shield prevents microwaves from escaping. It is designed as a screen to allow you to view food as it cooks.
- 2. Model and Serial Number Plate & Cooking Guide Label**
- 3. Charcoal Filter** (behind Vent Grille)

4. Vent Grille

5. Glass tray. The glass tray moves food as it cooks for more even cooking. It must be in the oven during operation for best cooking results.

6. Cooktop Light

7. Grease Filter. See "Caring for the filters" section.

8. Control Panel. Touch the buttons on this panel to perform all functions.

9. Cooking Rack. Use for extra space when cooking in more than one container at the same time.

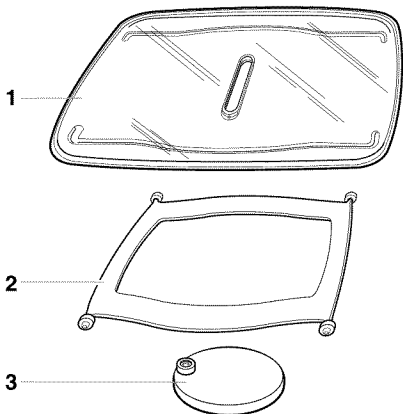

- 1. Glass tray
- 2. Support
- 3. Hub

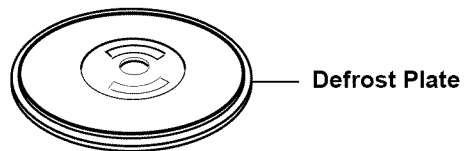

Use the DEFROST PLATE provided for complete defrosting.

The turntable rotates in both directions to help cook food more evenly. Do not operate the microwave oven without the turntable in place.

To Install:

- 1. Place the support on the oven cavity bottom.
- 2. Place the turntable on the support.

Fit the raised, curved lines in the center of the turntable bottom between the three spokes of the hub. The rollers on the support should fit inside the turntable bottom ridge.

Control panel features

Your microwave oven control panel lets you select the desired cooking function quickly and easily. All you have to do is touch the necessary Command Button. The following is a list of all the Command and Number Buttons located on the control panel. **For more information on these features, see the “Using your microwave oven” section.**

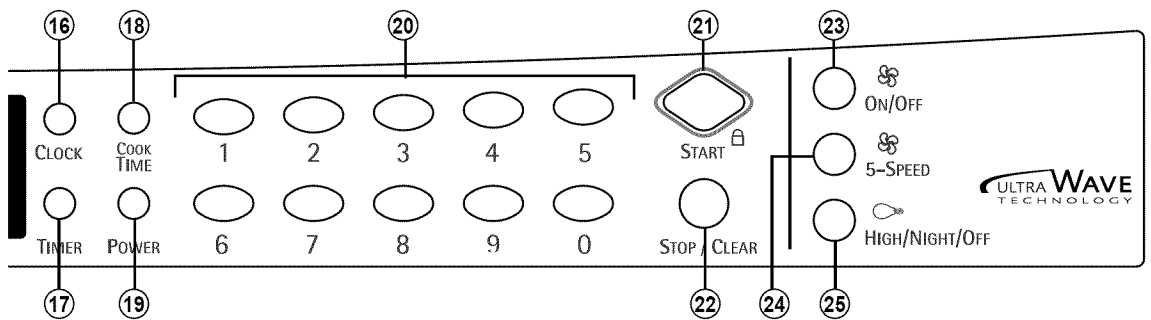
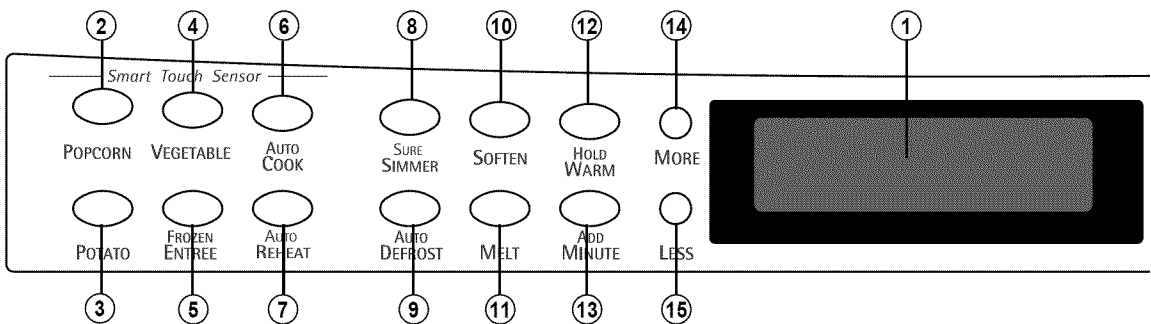
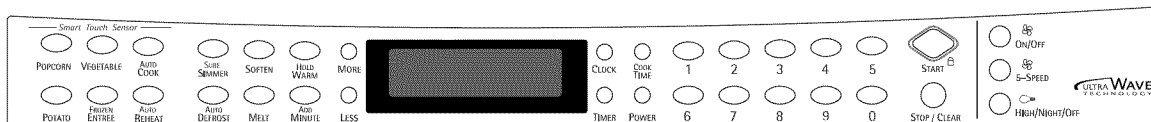

- 1. Display.** The display includes a clock and indicators to tell you time of day, cooking time settings, cook powers, quantities, weights, and cooking functions selected.
- 2. Popcorn.** Touch this button to pop popcorn with the sensor feature. The oven's sensor will tell the oven how long to cook depending on the amount of humidity it detects from the popcorn.
- 3. Potato.** Touch this button to cook potatoes without entering a cook time or power.
- 4. Vegetable.** Touch this button to cook vegetables without entering a cook time or power.
- 5. Frozen Entree.** Touch this button to cook a 10- to 21- ounce frozen entree without entering a cook time or power.
- 6. Auto Cook.** Touch this button to cook microwavable foods without entering a cook time or power.

- 7. Auto Reheat.** Touch this button to reheat microwavable foods without entering a cook time or power.
- 8. Sure Simmer.** Touch this pad to simmer soups, casseroles, stews, and other liquid foods.
- 9. Auto Defrost.** Touch this button followed by Number Buttons to thaw frozen meat by weight.
- 10. Soften.** Touch this button to soften ice cream, cream cheese, butter, or frozen juice.
- 11. Melt.** Touch this button to melt chocolate, cheese, butter, or marshmallows.
- 12. Hold Warm.** Touch this button to keep hot, cooked foods safely warm in your oven for up to 99 minutes, 99 seconds. Hold Warm can be used by itself, or it can automatically follow a cooking cycle.
- 13. Add Minute.** Touch this button to cook for 1 minute at 100% cook power, or to add extra minutes at the set cook power to your cooking cycle.
- 14. More.** Touch this button to add 10 seconds of cook time each time you press it.
- 15. Less.** Touch this button to subtract 10 seconds of cook time each time you press it.
- 16. Clock.** Touch this button to enter the time of day.
- 17. Timer.** Touch this button to change the oven's default settings for Kitchen Timer, Light Timer SET or CLEAR.
- 18. Cook Time.** Touch this button followed by Number Buttons to set a cooking time.
- 19. Power.** Touch this button after the cook time has been set, followed by a Number Button to set the amount of microwave energy released to cook the food. The higher the number, the higher the microwave power or "cooking speed."
- 20. Number Buttons.** Touch number buttons to enter cooking times, cook powers, quantities, weights, or food categories.
- 21. START.** Touch this button to start a function. If you open the door after the oven begins to cook, retouch START.
- 22. STOP/Clear.** Touch this button to erase an incorrect command, cancel a program during cooking, or to clear the Display.
- 23. Fan (🌀) On/Off.** Touch this button to turn the fan on or off.
- 24. Fan (🌀) 5-Speed.** Touch this button to choose one of 5 fan speeds.
- 25. Light (💡).** Touch this button to turn the light on high, night, or off.
- NOTE: If you try to enter** incorrect instructions, you will not hear any tones. Touch STOP/CLEAR and re-enter the instructions.

Using Your Microwave Oven

This section gives you instructions for operating each function. Please read these instructions carefully.

AUDIBLE SIGNALS







Audible signals are available to guide you when setting and using your oven:

- **A programming tone will sound** each time you touch a pad.
- **Seven tones** signal the end of a Kitchen Timer countdown.
- **Four tones** signal the end of a cooking cycle.

CLOCK

When your microwave oven is first plugged in or after a power failure, the Display will show "PLEASE SET TIME OF DAY". If a time of day is not set, ":" will show on the Display until you touch "Clock".

Example for 10:30 (AM).

- | Touch: | Display Shows: |
|--|-------------------------------------|
| 1.  STOP / CLEAR | |
| 2.  CLOCK | ENTER TIME OF DAY |
| 3.  1 0 3 0 | TOUCH START 10 : 30 |
| 4.  START | AM TOUCH 1 PM TOUCH 2 10 : 30 |
| 5.  1 | TOUCH START 10 : 30 AM |
| 6.  START | 10 : 30 AM |

NOTE: You can switch between AM and PM by touching 1 or 2 after step 4.

INTERRUPTING COOKING

You can stop the oven during a cycle by opening the door. The oven stops heating and the fan stops, but the light stays on.



To restart cooking, close the door and **Touch START**.

If you do not want to continue cooking, open the door and touch **STOP/Clear**.

CHILD LOCK

Use this safety feature to lock the control panel when you are cleaning the oven, or so that children cannot use the oven unsupervised.

To set CHILD LOCK:

- | Touch: | Display Shows: |
|---|---|
| 1.  STOP / CLEAR | Time of day. |
| 2.  START | Touch and hold until Locked appears in the display (approximately 4 seconds). |





To cancel CHILD LOCK:

- | Touch: | Display Shows: |
|---|--|
| 1.  START | Touch and hold until Locked disappears in the display (approximately 4 seconds). |





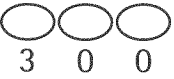

TIMER

TIMER provides two modes which make using your microwave oven quite handy. You can select KITCHEN TIMER, LIGHT TIMER SET or CLEAR.





Example for Kitchen Timer.

| | |
|--|---|
| Touch: | Display Shows: |
| 1.  STOP / CLEAR | Time of day. |
| 2.  TIMER Once for Timer. | KITCHEN TIMER ENTER TIME MIN & SEC --- TOUCH AGAIN for LIGHT TIMER |
| 3.  3 0 0 | TOUCH START 3:00 |
| 4.  START | KITCHEN TIMER and Time counting down |

Example for Light Timer.

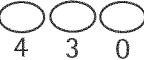
| | |
|---|--|
| Touch: | Display Shows: |
| 1.  STOP / CLEAR | Time of day. |
| 2.  TIMER Twice for Timer. | LIGHT TIMER TO SET LIGHT TIMER TOUCH 1 / TO CLEAR LIGHT TIMER TOUCH 2 |
| 3.  1 | LIGHT TIMER ENTER TIME OF DAY for LIGHT ON |
| 4.  1 1 3 0 | TOUCH START 11:30 |
| 5.  START | AM TOUCH 1 PM TOUCH 2 11:30 |
| 6.  2 | TOUCH START 11:30 PM |

Example for Light Timer.

| | |
|---|--|
| Touch: | Display Shows: |
| 7.  START | LIGHT TIMER ENTER TIME OF DAY for LIGHT OFF |
| 8.  4 3 0 | TOUCH START 4:30 |
| 9.  START | AM TOUCH 1 PM TOUCH 2 4:30 |
| 10.  1 | TOUCH START 4:30 AM |
| 11.  START | The display will show "LIGHT TIMER SET" once and then Time of day will be appeared. |

NOTE: To clear light timer, touch **TIMER** button twice and touch **2** button once. The display will show "LIGHT TIMER CLEAR" once and then Time of day will be appeared

TIMER FUNCTION TABLE

| TIMER BUTTON | OPTION | NUMBER BUTTON | RESULT |
|--------------|---------------|---------------|--------------------|
| Once | Kitchen Timer | | Time Counting Down |
| Twice | Light Timer | 1 | Light Set |
| | | 2 | Light Clear |

COOKTOP LIGHT

The button right of the control panel controls the cooktop light.

Example for Light HIGH.

Touch:

1.  HIGH/NIGHT/OFF

once for HIGH light
twice for NIGHT light

Display Shows:

The display will show "HIGH LIGHT" once.

2.  HIGH/NIGHT/OFF

To turn off, touch button once or twice depending on light setting.

The display will show "OFF LIGHT" once.

ADD MINUTE

A time-saving button, this simplified control lets you quickly set and start microwave cooking at 100% power without the need to touch START.

Example for 2 minutes.

Touch:

1.  STOP / CLEAR

Display Shows:

Time of day.

2.  Twice

TIME COOK
2:00 P-100

and Time counting down.

NOTE: Each time you touch ADD MINUTE, it will add 1 minute up to 99 min 59 seconds.

EXHAUST FAN

The button right of the control panel controls the 5-speed exhaust fan.

Example for exhaust fan speed to level 4

Touch:

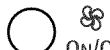
1.  ON/OFF

This shows the last level until you select the fan speed level.

Display Shows:

LEVEL 1 VENT FAN

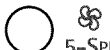
2.  5-SPEED

Touch until Level 4

LEVEL 4 VENT FAN

3.  ON/OFF

Turn off fan when desired

OFF VENT FAN





NOTE: If the temperature from the range or cooktop below the oven gets too hot, the exhaust fan in the vent hood will automatically turn on at the LEVEL 5 setting to protect the oven. It may stay on up to an hour to cool the oven. When this occurs, the  ON/OFF button will not turn the fan off.

TIMED COOKING

This feature lets you program a specific cook time and power. For best results, there are 10 power level settings in addition to HIGH (100%) power. Refer to the "Microwave Power Levels Table" on page 16 for more information.

NOTE: If you do not select a power level, the oven will automatically cook at HIGH (100%) power.

Example for 5 minutes, 30 seconds at 80% power.









- | Touch: | Display Shows: |
|--|--|
| 1.  | TIME COOK ENTER COOKING TIME |
| 2.  | TOUCH START or POWER 5 : 30 P-100 |
| 3.  | ENTER POWER LEVEL 1 to 10 5:30 P-100 |
| 4.  | TOUCH START 5:30 P-80 |
| 5.  | TIME COOK 5:30 P-80 and Time counting down. |

NOTE: After use of cook function, fan will run for 1 minute to cool if it senses too much heat.

MULTI-STAGE COOKING

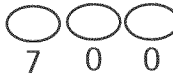
For best results, some recipes call for different cook powers during different stages of a cook cycle. You can program your oven to switch from one power level to another for up to 3 stages.

Example for 2-stage cook cycle.

- | Touch: | Display Shows: |
|---|--|
| 1.  | TIME COOK ENTER COOKING TIME |
| 2.  to set a 3 minute cook time for the first stage. | TOUCH START or POWER 3 : 00 P-100 |
| 3.  | ENTER POWER LEVEL 1 to 10 3 : 00 P-100 |
| 4.  to set an 80% cook power for the first stage. | TOUCH START 3 : 00 P-80 |
| 5.  | TIME COOK ENTER COOKING TIME |
| 6.  to set a 7 minute cook time for the second stage. | TOUCH START or POWER 7 : 00 P-100 |
| 7.  | ENTER POWER LEVEL 1 to 10 7 : 00 P-100 |
| 8.  to set a 50% cook power for the second stage. | TOUCH START 7 : 00 P-50 |
| 9.  | TIME COOK 3 : 00 P-80 and Time counting down. |
| 10. When the first stage is over, you will hear two short tones as the oven begins the second cook stage. | |

MICROWAVE POWER LEVELS

For best results, some recipes call for different cook powers. The lower the cook power, the slower the cooking. Each number from 1 to 9 stands for a different percentage of full cook power.

The following table gives the percentage of cook power each number pad stands for, and the cook power name usually used.

It also tells you when to use each cook power. Follow recipe or food package instructions if available.

| COOK POWER | NAME | WHEN TO USE IT |
|-----------------------|---------------------|---|
| 100% of full power | High | <ul style="list-style-type: none"> • Quick heating many convenience foods and foods with high water content, such as soups and beverages • Cooking tender cuts of meat, ground meat |
| 9 = 90% of full power | | <ul style="list-style-type: none"> • Heating cream soups |
| 8 = 80% of full power | | <ul style="list-style-type: none"> • Heating rice, pasta, or casseroles |
| 7 = 70% of full power | Medium-High | <ul style="list-style-type: none"> • Cooking and heating foods that need a Cook Power lower than high (for example, whole fish and meat loaf) or when food is cooking too fast • Reheating a single serving of food |
| 6 = 60% of full power | | <ul style="list-style-type: none"> • Cooking requiring special care, such as cheese and egg dishes, pudding, and custards • Finishing cooking casseroles |
| 5 = 50% of full power | Medium | <ul style="list-style-type: none"> • Cooking ham, whole poultry, and pot roasts • Simmering stews |
| 4 = 40% of full power | | <ul style="list-style-type: none"> • Melting chocolate • Heating pastries |
| 3 = 30% of full power | Medium-Low, Defrost | <ul style="list-style-type: none"> • Manually defrosting foods, such as bread, fish, meats, poultry, and precooked foods |
| 2 = 20% of full power | | <ul style="list-style-type: none"> • Softening butter, cheese, and ice cream |
| 1 = 10% of full power | Low | <ul style="list-style-type: none"> • Keeping food warm • Taking chill out of fruit |

AUTO DEFROST

Four defrost sequences are preset in the oven. The auto defrost feature provides you with the best defrosting method for frozen foods. The cooking guide will show you which defrost sequence is recommended for the food you are defrosting. For added convenience, the Auto Defrost includes a built-in beep mechanism that reminds you to check, turn over, separate, or rearrange to get best defrost results.

1. **MEAT**
2. **POULTRY**
3. **FISH**
4. **BREAD**

Example for 1.2 lbs of ground beef.

Touch:



Display Shows:

**MEAT TOUCH 1
POULTRY TOUCH 2
FISH TOUCH 3
BREAD TOUCH 4**



**MEAT
ENTER WEIGHT**

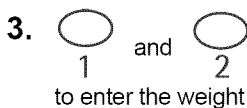

**TOUCH START
1.2 LBS**



**DEFROST and
Time counting down**

NOTE:

When you touch the START pad, the display changes to defrost time count down. The oven will beep during the DEFROST cycle. At this time, open the door and turn, separate, or rearrange the food. Remove any portions that have thawed. Return frozen portions to the oven and touch START to resume the defrost cycle.

Operating Tips

- For best results, remove fish, shellfish, meat, and poultry from its original closed paper or plastic package (wrapper). Otherwise, the wrap will hold steam and juice close to the foods, which can cause the outer surface of the foods to cook.
- For best results, shape your ground meat into the form of a doughnut before freezing. When defrosting, scrape off thawed meat when the beep sounds and continue defrosting.
- Place foods in a shallow container or on a microwave roasting rack to catch drippings.

This table shows you food type selections and the weights you can set for each type. For best results, loosen or remove covering on food.

| FOOD | TOUCH Auto Defrost | WEIGHTS YOU CAN SET (tenths of a pound) |
|---------|--------------------|---|
| Meat | 1 | .1 to 6.0 (45g to 2722g) |
| Poultry | 2 | .1 to 6.0 (45g to 2722g) |
| Fish | 3 | .1 to 6.0 (45g to 2722g) |
| Bread | 4 | .1 to 1.0 (45g to 450g) |

Weight conversion table

You are probably used to food weights as being in pounds and ounces that are fractions of a pound (for example, 4 ounces equals 1/4 pound). However, in order to enter food weight in Auto Defrost, you must specify pounds and tenths of a pound.

If the weight on the food package is in fractions of a pound, you can use the following table to convert the weight to decimals.

| EQUIVALENT WEIGHT | | |
|-------------------|----------------|----------------------|
| OUNCES | DECIMAL WEIGHT | |
| 1.6 | .10 | |
| 3.2 | .20 | |
| 4.0 | .25 | One-Quarter Pound |
| 4.8 | .30 | |
| 6.4 | .40 | |
| 8.0 | .50 | One-Half Pound |
| 9.6 | .60 | |
| 11.2 | .70 | |
| 12.0 | .75 | Three-Quarters Pound |
| 12.8 | .80 | |
| 14.4 | .90 | |
| 16.0 | 1.00 | One Pound |

AUTO DEFROST TABLE

Meat setting

| FOOD | SETTING | AT BEEP | SPECIAL INSTRUCTIONS |
|------------------------------|---------|---|--|
| BEEF | | | |
| Ground Beef, Bulk | MEAT | Remove thawed portions with fork. Turn over. Return remainder to oven. | Do not defrost less than 1/4 lb. Freeze in doughnut shape. Place on the DEFROST PLATE. |
| Ground Beef, Patties | MEAT | Separate and rearrange. | Do not defrost less than 2 oz. patties. Depress center when freezing. |
| Round Steak | MEAT | Turn over. Cover warm areas with aluminum foil. | Place on the DEFROST PLATE. |
| Tenderloin Steak | MEAT | Turn over. Cover warm areas with aluminum foil. | Place on the DEFROST PLATE. |
| Stew Beef | MEAT | Remove thawed portions with fork. Separate remainder. Return remainder to oven. | Place in a microwavable baking dish. |
| Pot Roast, Chuck Roast | MEAT | Turn over. Cover warm areas with aluminum foil. | Place on the DEFROST PLATE. |
| Rib Roast | MEAT | Turn over. Cover warm areas with aluminum foil. | Place on the DEFROST PLATE. |
| Rolled Rump Roast | MEAT | Turn over. Cover warm areas with aluminum foil. | Place on the DEFROST PLATE. |
| LAMB | | | |
| Cubes for Stew | MEAT | Remove thawed portions with fork. Return remainder to oven. | Place in a microwavable baking dish. |
| Chops (1 inch thick) | MEAT | Separate and rearrange. | Place on the DEFROST PLATE. |
| PORK | | | |
| Chops (1/2 inch thick) | MEAT | Separate and rearrange. | Place on the DEFROST PLATE. |
| Hot Dogs | MEAT | Separate and rearrange. | Place on the DEFROST PLATE. |
| Spareribs Country-style Ribs | MEAT | Turn over. Cover warm areas with aluminum foil. | Place on the DEFROST PLATE. |
| Sausage, Links | MEAT | Separate and rearrange. | Place on the DEFROST PLATE. |
| Sausage, Bulk | MEAT | Remove thawed portions with fork. Turn over. Return remainder to oven. | Place in a microwavable baking dish. |
| Loin Roast, Boneless | MEAT | Turn over. Cover warm areas with aluminum foil. | Place on the DEFROST PLATE. |

AUTO DEFROST TABLE (CONT.)

Poultry setting

| FOOD | SETTING | AT BEEP | SPECIAL INSTRUCTIONS |
|--|---------|---|--|
| CHICKEN Whole (up to 6 lbs) Cut-up | POULTRY | Turn over (finish defrosting breast-side down). Cover warm areas with aluminum foil. | Place chicken breast-side up on the DEFROST PLATE. Finish defrosting by immersing in cold water. Remove giblets when chicken is partially defrosted. |
| | | Separate pieces and rearrange. Turn over. Cover warm areas with aluminum foil. | Place on the DEFROST PLATE. Finish defrosting by immersing in cold water. |
| CORNISH HENS Whole | POULTRY | Turn over. Cover warm areas with aluminum foil. | Place on the DEFROST PLATE. Finish defrosting by immersing in cold water. |
| TURKEY Breast (up to 6 lbs) | POULTRY | Turn over. Cover warm areas with aluminum foil. | Place on the DEFROST PLATE. Finish defrosting by immersing in cold water. |

Fish setting

| FOOD | SETTING | AT BEEP | SPECIAL INSTRUCTIONS |
|---|---------|--|--|
| FISH Fillets Steaks Whole | FISH | Turn over. Separate fillets when partially thawed if possible. | Place in a microwavable baking dish. Carefully separate fillets under cold water. |
| | | Separate and rearrange. | Place in a microwavable baking dish. Run cold water over to finish defrosting. |
| | | Turn over. | Place in a microwavable baking dish. Finish defrosting by immersing in cold water. |
| SHELLFISH Crabmeat Lobster tails Shrimp Scallops | FISH | Break apart. Turn over. | Place in a microwavable baking dish. |
| | | Turn over and rearrange. | Place in a microwavable baking dish. |
| | | Separate and rearrange. | Place in a microwavable baking dish. |
| | | Separate and rearrange. | Place in a microwavable baking dish. |

Bread setting

| FOOD | SETTING | AT BEEP | SPECIAL INSTRUCTIONS |
|---|---------|--------------------------|-----------------------------------|
| Bagel Dinner Roll Muffin Hamburger Hot Dog Bun Slices of Bread Loaf of Bread | BREAD | Turn over and rearrange. | Place on 3 sheets of paper towel. |

DEFROSTING TIPS

- **When using Auto Defrost**, the weight to be entered is the net weight in pounds and tenths of pounds (the weight of the food minus the container).
- **Before starting**, make sure you have removed any of the metal twist-ties which often come with frozen food bags, and replace them with strings or elastic bands.
- **Open containers** such as cartons before they are placed in the oven.
- **Always slit** or pierce plastic pouches or packaging.
- **If food is foil wrapped**, remove foil and place it in a suitable container.
- **Slit** the skins, if any, of frozen food such as sausage.
- **Bend** plastic pouches of food to ensure even defrosting.
- **Always underestimate** defrosting time. If defrosted food is still icy in the center, return it to the microwave oven for more defrosting.
- **The length** of defrosting time varies according to how solidly the food is frozen.
- **The shape of the package** affects how quickly food will defrost. Shallow packages will defrost more quickly than a deep block.
- **As food begins to defrost**, separate the pieces. Separated pieces defrost more easily.
- **For better results**, let food stand after defrosting. (For more information on standing time, see the "Microwave Cooking Tips" section.)
- **Turn over** food during defrosting or standing time. Break apart and remove food as required.

HOLD WARM

You can safely keep hot, cooked food warm in your microwave oven for up to 99 minutes, 99 seconds (about 1 hour, 40 minutes). You can use Hold Warm by itself, or to automatically follow a cooking cycle.

Example for hold warm.

Touch:

Display Shows:



**HOLD WARM
TOUCH START**



HOLD WARM

At the end of the hold warm, four tones will sound.

To make Hold Warm automatically follow another cycle:

- **While you are touching in cooking instructions**, touch HOLD WARM before touching START.
- **When the last cooking cycle is over**, you will hear two tones. "Hold Warm" will come on while the oven continues to run.
- You can set Hold Warm to follow Auto Defrost, Cook, or multi-cycle cooking.

NOTES:

- **Hold Warm** operates for up to 99 minutes, 99 seconds.
- **Opening** the oven door cancels Hold Warm. Close the door and touch Hold Warm, then touch START if additional Hold Warm time is desired.
- **Food cooked covered** should be covered during Hold Warm.
- **Pastry items** (pies, turnovers, etc.) should be uncovered during Hold Warm.
- **Complete meals** kept warm on a dinner plate should be covered during Hold Warm.
- **Do not use** more than one complete Hold Warm cycle (about 1 hour, 40 minutes). The quality of some foods will suffer with extended time.

SURE SIMMER

Your microwave oven lets you simmer soups, casseroles, stews, and other liquid foods. All you do is set a simmer time and your oven will bring your food to a boil and then simmer it for the time you specify.

NOTES:

- You cannot change the cook power or doneness for Sure Simmer.
- This function uses the sensor. The sensor needs 2 minutes 30 seconds to warm up after the oven is connected to power or after a power failure. If you start Sure Simmer during the warm up, microwave energy will not be turned on until the sensor is warm.
- When cooking vegetables, increase amount of water to 1/4 to 1/2 cup (60 to 125ml).
- Cover dish with a hard lid, i.e., the lid that comes with the dish or a dinner plate. Do not use plastic wrap.

Touch:

Display Shows:

1. Place the food in the oven and close the door.



**SURE SIMMER
ENTER COOKING
TIME**

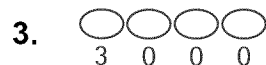

**TOUCH START
30:00**

Touch Number buttons to enter the simmer time. Example for 30 minutes.



**SURE SIMMER
(SENSOR)**
The oven will bring the food to a boil.

The food will then simmer for the time you set.

When simmering foods like pasta use a container that can hold enough water to cover the food completely when cooking, such as a 3-quart (12 cup) casserole with a lid. When cooking pasta or noodles, add 1 tbsp (15ml) oil to the water before boiling.

Use the following method:

Place container with water in the oven and follow steps 2~4, setting the simmer time at 1 second. At the end of the signal, place the food in the water and stir until completely covered by water. Cover. Repeat steps 2~4, setting the simmer time you want.

Changing instructions you can change the simmering time while simmering by repeating steps 2, 3, and 4.

Using Sensor Cooking

SENSOR COOKING

SENSOR OPERATING INSTRUCTIONS

Sensor Cook allows you to cook most of your favorite foods without selecting cooking times and power levels. The oven automatically determines required cooking time for each food item. When the internal sensor detects a certain amount of humidity coming from the food, it will tell the oven how much longer to heat. The display will show the remaining heat time. For best results by Sensor, following these recommendations.

- Food cooked with the sensor system should be at normal storage temperature.
- Glass Tray and outside of container should be dry to assure best cooking results.
- Foods should always be covered loosely with microwavable plastic wrap, waxed paper or a lid.
- Do not open the door or touch the "STOP/CLEAR" key during the sensing time. When sensing time is over, the oven beeps twice and the remaining cooking time will appear in the display window. At this time you can open the door to stir, turn, or rearrange the food.

SENSOR COOKING GUIDE

Appropriate containers and coverings help assure good Sensor cooking results.

- Always use microwavable containers and cover them with lids or vented plastic wrap.
- Never use tight-sealing plastic covers. They can prevent steam from escaping and cause food to overcook.
- Match the amount to the size of the container. Fill containers at least half full for best results.
- Be sure the outside of the cooking container and the inside of the microwave oven are dry before placing food in the oven. Beads of moisture turning into steam can mislead the sensor.

POTATO (EXAMPLE)

Sensor cook allows you to cook most of your favorite foods without selecting cooking times and power levels.

Example for potato.

Touch:

Display Shows:

1. 
STOP / CLEAR

Time of day.

2. 
POTATO

POTATO
(SENSOR)

When the cook time is over, you will hear four beeps and **COOK END** will be displayed.

MORE/LESS

By using the MORE or LESS pads all of the sensor cook and time cook settings can be adjusted to cook food for a longer or shorter time.

Pressing MORE will add 10 seconds of cooking time each time you press it.

Pressing LESS will subtract 10 seconds of cooking time each time you press it.



SENSOR COOKING TABLE

| CATEGORY | | DIRECTION | AMOUNT |
|----------------------|-------------------------|--|---------------------------------------|
| Popcorn | | Popcorn lets you pop commercially packaged microwave popcorn. Pop only one package at a time. For best results, use fresh bag of popcorn. Place bag of prepackaged microwave popcorn on the center of turntable. Before popping, remove the rack from the oven (refer to Page 32). | 3.0~3.5 oz. package |
| Potato | | Pierce each potato with a fork and place the oven tray around the edge, at least one inch apart. After cooking, allow to stand for 5 minutes. | 1~4 medium (approx. 8 to 10 oz. each) |
| Vegetable | Fresh Vegetable | Prepare as desired, wash and leave residual water on the vegetables. Place in an appropriately sized microwave container. Add amount of water according to the quantity. (1~2 cups : 2 tablespoons, 3~4 cups : 4 tablespoons). Cover with plastic wrap and vent. After cooking, stir and allow to stand for 3 minutes. | 1~4 cups |
| | Frozen Vegetable | Remove from package, rinse off frost under running water. Place in an appropriately sized microwave container. Add amount of water according to the quantity. (1~2 cups : 2 tablespoons, 3~4 cups : 4 tablespoons). Cover with plastic wrap and vent. After cooking, stir and allow to stand for 3 minutes. | 1~4 cups |
| | Canned Vegetable | Remove from the outer display can. Place in an appropriately sized microwave container, cover with plastic wrap and vent. After cooking, stir and allow to stand for 3 minutes. | 1~4 cups |
| Frozen Entree | | Remove from outer display package. Slit cover. If not in microwave-safe container, place on a plate. Cover with plastic wrap and vent the plastic film by piercing with a fork (3 times). After cooking, allow to stand for 3 minutes. | 10 to 21 oz. |

AUTO COOK

Auto Cook lets you heat common microwave-prepared foods without selecting cooking times and power levels. Auto Cook has preset cook powers for 4 food categories: Casserole, Rice, Bacon, and Hot Cereal.

Example for Rice.

- | | |
|--|---|
| Touch: | Display Shows: |
| 1.  Auto COOK | SELECT MENU 1 to 4 --- SEE COOKING GUIDE |
| 2.  2 | RICE (SENSOR) |

Choose food category:

| CATEGORY | TOUCH NUMBER BUTTON | QUANTITY |
|--------------------|------------------------|-----------------|
| Casserole (Sensor) | 1 | 1 to 4 cups |
| Rice (Sensor) | 2 | 1/2 to 2 cups |
| Bacon | 3 | 2 to 4 slices |
| Hot Cereal | 4 | 1 to 6 servings |



The oven will cook food automatically by sensor system, except Bacon and Hot Cereal. When the cook time is over, you will hear four beeps and **COOK END** will be displayed.

AUTO REHEAT

Auto Reheat lets you heat foods without selecting cooking times and power levels.

Auto Reheat has preset cook powers for 5 categories: Casserole, Dinner Plate, Soup/Sauce, Roll/Muffin, and Beverage.

Example for Casserole.

- | | |
|--|--|
| Touch: | Display Shows: |
| 1.  Auto REHEAT | SELECT MENU 1 to 5 -- SEE COOKING GUIDE |
| 2.  1 | CASSEROLE (SENSOR) |

Choose food category.

| CATEGORY | TOUCH NUMBER BUTTON | QUANTITY |
|-----------------------|------------------------|-----------------|
| Casserole (Sensor) | 1 | 1 to 4 cups |
| Dinner Plate (Sensor) | 2 | 1 to 2 Servings |
| Soup/Sauce (Sensor) | 3 | 1 to 4 cups |
| Roll/Muffin | 4 | 1 to 6 pieces |
| Beverage | 5 | 1 to 2 cups |

The oven will reheat food automatically by sensor system, except Roll/Muffin and Beverage. When the cook time is over, you will hear four beeps and **COOK END** will be displayed.

AUTO COOK TABLE

| CATEGORY | TOUCH NUMBER BUTTON | DIRECTION | AMOUNT |
|-------------------------------|------------------------|---|---|
| Casserole (Sensor) | 1 | Assemble the ingredients per the recipe in a 1~2- quart casserole. Cover with plastic wrap and vent. After cooking, stir and allow to stand for 3 minutes. | 1~4 cups |
| Rice (Sensor) | 2 | Place rice and twice as much liquid (water, chicken, or vegetable stock) in a 2- quart microwave dish. Cover with plastic wrap and vent. After cooking, allow to stand for 10 minutes. Stir for fluffier rice. | 1/2~2 cups Use medium or long grain rice. Cook instant rice according to directions on the package. |
| Bacon | 3 | Place bacon strips on a microwave bacon rack for best results. (Use dinner plate lined with paper towels if rack is not available) | 2~4 slices |
| Hot Cereal | 4 | Prepare as directed on package and cook. Stir well before eating. Use only instant hot cereal. | 1~6 servings |





AUTO REHEAT TABLE

| CATEGORY | TOUCH NUMBER BUTTON | DIRECTION | AMOUNT |
|----------------------------------|------------------------|--|---------------------------------------|
| Casserole (Sensor) | 1 | Cover dish containing the casserole with plastic wrap and vent. After cooking, stir and allow to stand for 3 minutes. | 1~4 cups |
| Dinner Plate (Sensor) | 2 | Place on a low plate. Cover with vented plastic wrap. Let stand 3 minutes. | 1~2 servings |
| Soup/Sauce (Sensor) | 3 | Place in shallow microwavable casserole. Cover with vented plastic wrap. After cooking, stir and let stand 3 minutes. | 1~4 cups |
| Roll/Muffin | 4 | Remove from display package and place on a plate. | 1~6 pieces (2~3 oz. each) fresh |
| Beverage | 5 | Use a wide-mouth mug. Do not cover. Remove from display package and place on a plate. (Be careful! The beverage will be very hot! Sometimes liquids heated in cylindrical containers will splash out when the cup is moved.) | 1~2 cups (240 ml per cup) |

SOFTEN

The oven uses low power to soften foods (butter, ice cream, cream cheese, and frozen juice) See the following table.

Example for quart of ice cream.





- | | |
|--|--|
| Touch: | Display Shows: |
| 1.  STOP / CLEAR | Time of day. |
| 2.  SOFTEN | SELECT MENU 1 to 4 --- SEE COOKING GUIDE |
| 3.  2 | ICE CREAM TOUCH 1 to 3 |
| 4.  2 | The display will show ICE CREAM QUART once, ICE CREAM and Time counting down. |

When the cook time is over, you will hear four beeps and **COOK END** will be displayed.

MELT

The oven uses low power to melt foods (butter or margarine, chocolate, marshmallows, or processed cheese food). See the following table.

Example for 8 oz. Chocolate.

- | | |
|--|---|
| Touch: | Display Shows: |
| 1.  STOP / CLEAR | Time of day. |
| 2.  MELT | SELECT MENU 1 to 4 --- SEE COOKING GUIDE |
| 3.  2 | CHOCOLATE TOUCH 1 to 2 |
| 4.  2 | The display will show CHOCOLATE 8 OZ once, CHOCOLATE and Time counting down. |

When the cook time is over, you will hear four beeps and **COOK END** will be displayed.

SOFTEN TABLE

| CODE | CATEGORY | DIRECTION | AMOUNT |
|------|---------------------|---|--------------------------|
| 1 | Butter | Unwrap and place in microwavable container. Butter will be at room temperature and ready for use in recipe. | 1, 2 or 3 sticks |
| 2 | Ice cream | Place container in oven. Ice cream will be soft enough to make scooping easier. | Pint, Quart, Half gallon |
| 3 | Cream cheese | Unwrap and place in microwavable Container. Cream cheese will be at room temperature and ready for use in recipe. | 3 or 8 oz. |
| 4 | Frozen juice | Remove top. Place in oven. Frozen juice will be soft enough to easily mix with water. | 6, 12 or 16 oz. |

MELT TABLE

| CODE | CATEGORY | DIRECTION | AMOUNT |
|------|----------------------------|---|------------------|
| 1 | Butter or Margarine | Unwrap and place in microwavable container. No need to cover butter. Stir at the end of cooking to complete melting. | 1, 2 or 3 sticks |
| 2 | Chocolate | Chocolate chips or squares of baking chocolate may be used. Unwrap squares and place in microwavable container. Stir at the end of cycle to complete melting. | 4 or 8 oz. |
| 3 | Cheese | Use processed cheese food only. Cut into cubes. Place in a single layer in microwavable container. Stir at the end of cooking to complete melting. | 8 or 16 oz. |
| 4 | Marshmallows | Large or miniature marshmallows may be used. Place in microwavable container. Stir at the end of cycle to complete melting. | 5 or 10 oz. |

Caring for Your Microwave Oven

To make sure your microwave oven looks good and works well for a long time, you should maintain it properly. For proper care, please follow these instructions carefully.

For interior surfaces: Wash often with warm, sudsy

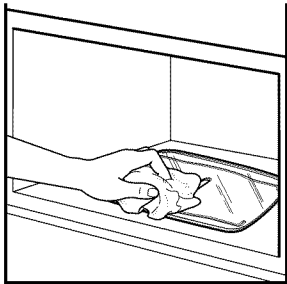

water and a sponge or soft cloth. **Use** only mild, nonabrasive soaps or a mild detergent. **Be sure to keep the areas clean where the door and oven frame touch when closed.** Wipe well with clean cloth.

Over time, stains can occur on the surfaces as the result of food particles spattering during cooking. This is normal.

For stubborn soil, boil a cup of water in the oven for 2

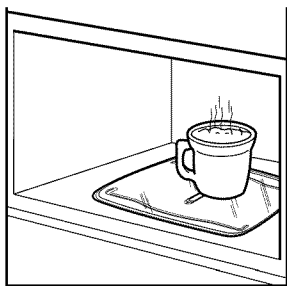

to 3 minutes. Steam will soften the soil. To get rid of odors inside the oven, boil a cup of water with some lemon juice or vinegar in it.

For exterior surfaces and control panel: Use a soft

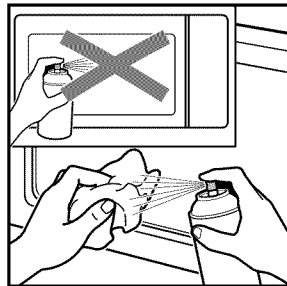

cloth with spray glass cleaner. Apply the spray glass cleaner to the soft cloth; do not spray directly on the oven.

NOTE: Abrasive cleansers, steel wool pads, gritty wash cloths, some paper towels, etc., can

damage the control panel and the interior and exterior oven surfaces.

To clean glass tray and support, wash in mild, sudsy water; for heavily soiled areas **use** a mild cleanser and scouring sponge. The glass tray and support are dishwasher safe.

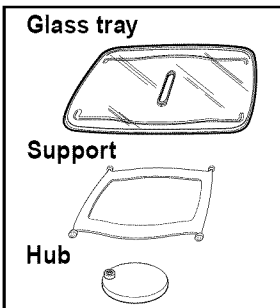

To use of the metal rack:

The metal rack gives you extra space when cooking in more than one container at the same time.

1. Place rack securely in the four plastic supports.
 - Rack **must not touch** metal walls or back of microwave oven.
2. Place equal amounts of food **both above and below rack.**

To avoid risk of property damage:

1. Do not cook with rack on floor of the oven.
2. Use the metal rack when cooking equal amounts of food at the same time.
3. Do not use rack to pop popcorn.
4. Rack must be on the four plastic supports when used.

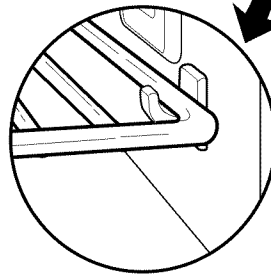
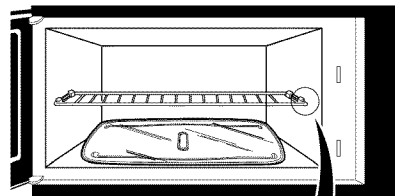

CARING FOR THE FILTERS

The grease filter should be removed and cleaned often, at least once a month.

NOTE: If your microwave hood combination is installed to recirculate air, the charcoal filter (Part No. 5230W1A003A) available from Sears by calling 1-800-4-MY-HOME®. The charcoal filter cannot be cleaned and should be replaced every 6 to 12 months.

Grease filter (Part No. 5230W2A004A):

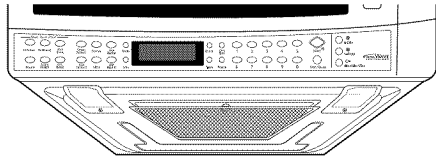

1. Unplug microwave oven or disconnect power.

2. To remove grease filter, slide each filter to the side. Pull filter downward and push to the other side. The filter will drop out.

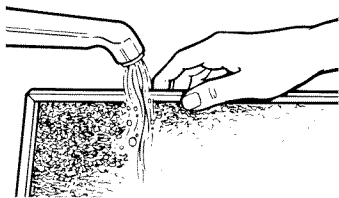

3. Soak grease filter in hot water and a mild detergent. Scrub and swish to remove embedded dirt and grease. Rinse well and shake to dry. Do not clean filter with ammonia, corrosive cleaning agents such as lye-based oven cleaners, or place them in a dishwasher. The filter will turn black or could be damaged.

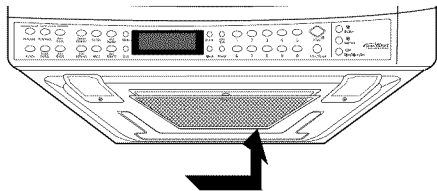

4. To replace grease filter, slide filter in the frame slot on back side of the opening. Push filter upward and push to front side to lock into place.

5. Plug in microwave oven or reconnect power.

Charcoal filter (Part No. 5230W1A003A):

1. Unplug microwave oven or disconnect power.

2. Remove the vent grille mounting screws.

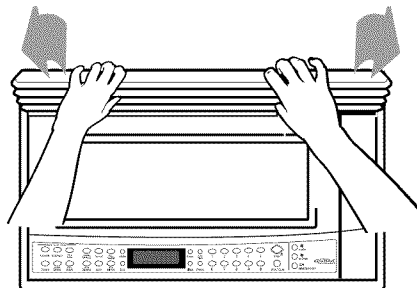

3. Push the right side lower part of the charcoal filter. Remove the filter.

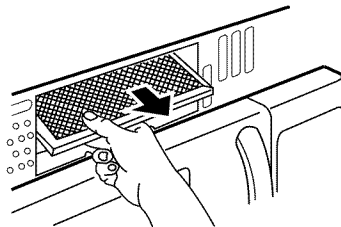

4. Lift the back of the charcoal filter. Slide the filter straight out.

REPLACING THE COOKTOP AND OVEN LIGHTS

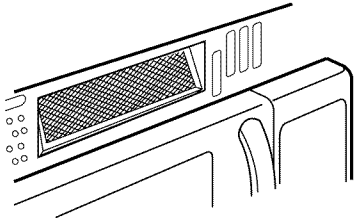

5. Slide a new charcoal filter into place. The filter should rest at the angle shown.

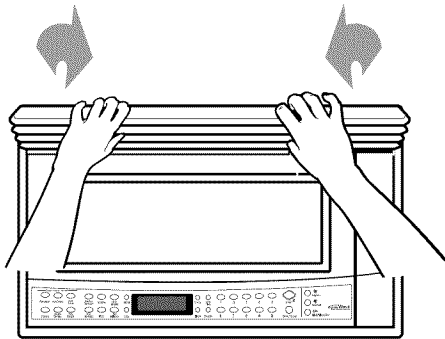

6. Slide the bottom of the vent grille into place. Push the top until it snaps into place. Replace the mounting screws.

7. Plug in microwave oven or reconnect power.

NOTE: Do not operate the hood without the grease filters in place.

The cooktop light

1. Unplug microwave oven or disconnect power.

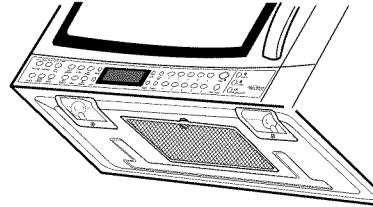

2. Remove the bulb cover mounting screw.

3. Replace bulb with candelabra-base 35-watt bulb (Part No. 6912A40002D) available from Sears by calling 1-800-4-MY-HOME®.

4. Plug in microwave oven or reconnect power.

The oven light

1. Unplug microwave oven or disconnect power.

2. Remove the vent grille mounting screws.

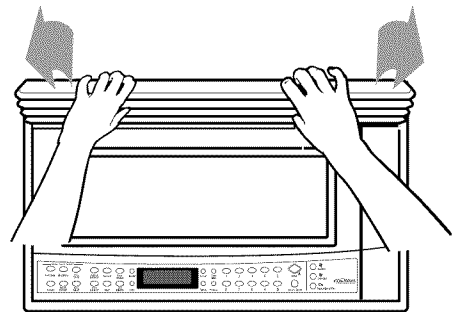

3. Tip the grille forward, then lift out to remove.

Bulb holder

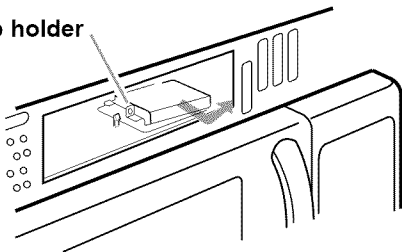

4. Lift up the bulb holder.

5. Replace the bulb with a candelabra-base 35-watt bulb (Part No. 6912A40002D) available from Sears by calling 1-800-4-MY-HOME®.

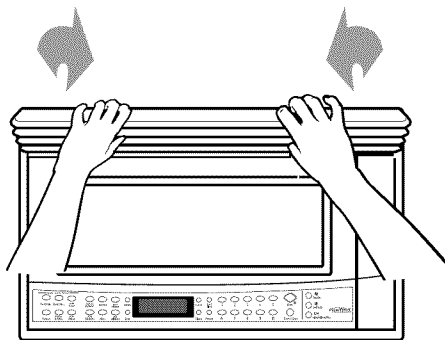

6. Slide the top of the vent grille into place. Push the bottom until it snaps into place. Replace the mounting screws.

7. Plug in microwave oven or reconnect power.

MICROWAVE COOKING TIPS

Amount of food

- **If you increase or decrease** the amount of food you prepare, the time it takes to cook that food will also change. For example, if you double a recipe, add a little more than half the original cooking time. Check for doneness and, if necessary, add more time in small increments.

Starting temperature of food

- **The lower the temperature** of the food being put into the microwave oven, the longer it takes to cook. Food at room temperature will be re-heated more quickly than food at refrigerator temperature.

Composition of food

- **Food with a lot of fat and sugar** will be heated faster than food containing a lot of water. Fat and sugar will also reach a higher temperature than water in the cooking process.
- **The more dense the food**, the longer it takes to heat. "Very dense" food like meat takes longer to heat than lighter, more porous food like sponge cakes.

Size and shape

- **Smaller pieces of food** will cook faster than larger pieces. Also, same-shaped pieces cook more evenly than different-shaped pieces.
- **With foods that have different thicknesses**, the thinner parts will cook faster than the thicker parts. **Place** the thinner parts of chicken wings and legs in the center of the dish.

Stirring, turning foods

- **Stirring and turning foods** spreads heat quickly to the center of the dish and avoids overcooking at the outer edges of the food.

Covering food

Cover food to:

- **Reduce** splattering
- **Shorten** cooking times
- **Keep** food moist

You can use any covering that lets microwaves pass through. See "Getting to Know Your Microwave Oven" for materials that microwaves will pass through. If you are using the Sensor function, be sure to vent.

Releasing pressure in foods

- **Several foods** (for example: baked potatoes, sausages, egg yolks, and some fruits) are tightly covered by a skin or membrane. Steam can build up under the membrane during cooking, causing the food to burst. To relieve the pressure and to prevent bursting, **pierce** these foods before cooking with a fork, cocktail pick, or toothpick.

Using standing time

- **Always allow food to stand** after cooking. Standing time after defrosting and cooking allows the temperature to evenly spread throughout the food, improving the cooking results.
- **The length of the standing time** depends on how much food you are cooking and how dense it is. Sometimes it can be as short as the time it takes you to remove the food from the oven and take it to the serving table. However, with larger, denser food, the standing time may be as long as 10 minutes.

Arranging food

For best results, place food evenly on the plate. You can do this in several ways:

- **If you are cooking several items of the same food**, such as baked potatoes, **place** them in a ring pattern for uniform cooking.
- **When cooking foods of uneven shapes or thickness, such as chicken breasts**, **place** the smaller or thinner area of the food towards the center of the dish where it will be heated last.
- **Layer thin slices of meat** on top of each other.
- **When you cook or reheat whole fish**, **score** the skin – this prevents cracking.
- **Do not** let food or a container touch the top or sides of the oven. This will prevent possible arcing.

Using aluminum foil

Metal containers should not be used in a microwave oven. There are, however, some exceptions. If you have purchased food which is prepackaged in an aluminum foil container, refer to the instructions on the package. When using aluminum foil containers, cooking times may be longer because microwaves will only penetrate the top of the food. If you use aluminum containers without package instructions, follow these guidelines:

MICROWAVE COOKING TIPS (CONT.)

Using aluminum foil (cont.)

- **Place** the container in a glass bowl and add some water so that it covers the bottom of the container, not more than 1/4 in. (.64 cm) high. This ensures even heating of the container bottom.
- **Always remove** the lid to avoid damage to the oven.
- **Use only** undamaged containers.
- **Do not use** containers taller than 3/4 in. (1.9 cm).
- **Container must be** at least half filled.
- **To avoid arcing**, there must be a minimum 1/4 in. (.64 cm) between the aluminum container and the walls of the oven and also between two aluminum containers.
- **Always place** the container on the turntable.
- **Shield** with small pieces of aluminum foil, parts of food that may cook quickly, such as wing tips and leg ends of poultry.
- **Heating food** in aluminum foil containers usually takes up to double the time compared to reheating in plastic, glass, china, or paper containers. The time when food is ready will vary depending upon the type of container you use.
- **Let food stand** for 2 to 3 minutes after heating so that heat is spread evenly throughout container.

Cooking you should not do in your microwave oven

- **Do not** do canning of foods in the oven. Closed glass jars may explode, resulting in damage to the oven.
- **Do not** use the microwave oven to sterilize objects (baby bottles, etc.). It is difficult to keep the oven at the high temperature needed for sterilization.

Removing the rack

- When popping commercially packaged popcorn, **Remove the rack from the oven**; Do not place the bag of microwave popcorn on the rack or under the rack.
- In the case of popping microwave popcorn with rack, that can cause the fire or damage to your microwave oven.

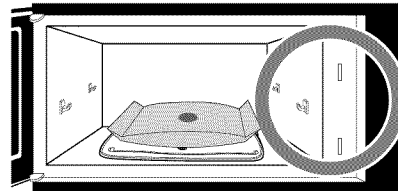
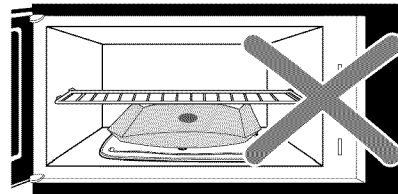
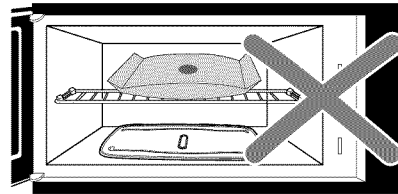

Questions and Answers

| QUESTIONS | ANSWERS |
|--|--|
| Can I operate my microwave oven without the glass tray or move the glass tray over to hold a large dish? | No. If you remove or move the glass tray, you will get poor cooking results. Dishes used in your oven must fit on the glass tray. |
| Can I use either metal or aluminum pans in my microwave oven? | You can use aluminum foil for shielding (use small, flat pieces), small skewers, and shallow foil trays (if tray is not taller than 3/4 in. [1.9 cm] deep and is filled with food to absorb microwave energy). Never allow metal to touch walls or door. |
| Is it normal for the glass tray to move in either direction? | Yes. The glass tray moves from side to side, depending on the rotation of the motor when the cooking cycle begins. |
| Sometimes the door of my microwave oven appears wavy. Is this normal? | This appearance is normal and does not affect the operation of your oven. |
| Why does the dish become hot when I microwave food in it? I thought that this should not happen. | As the food becomes hot it will conduct the heat to the dish. Be prepared to use hot pads to remove food after cooking. |
| What does “standing time” mean? | “Standing time” means that food should be removed from the oven and covered for additional time to allow it to finish cooking. This frees the oven for other cooking. |
| Why does steam come out of the air exhaust vent? | Steam is normally produced during cooking. The microwave oven has been designed to vent this steam out the vents. |
| Can I pop popcorn in my microwave oven? How do I get the best results? | Yes. Pop packaged microwave popcorn following manufacturer’s guidelines. Do not use regular paper bags. Do not repop unpopped kernels. Do not pop popcorn in glass cookware. |

Troubleshooting

Most cooking problems often are caused by little things you can find and fix without tools of any kind. Check the lists below and on the next page before calling for assistance or service. If you still need help, call Sears Service at 1-800-4-MY-HOME®.

MICROWAVE OVEN DOES NOT WORK

| PROBLEM | CAUSE |
|----------------------------------|--|
| Nothing works. | <ul style="list-style-type: none">• The power supply cord is not plugged into a grounded 3 prong outlet. (See the "Electrical Requirements" section on page 6 and the "Electrical connection" section on Page 8.)• A household fuse has blown or a circuit breaker has tripped.• The electric company has had a power failure. |
| The microwave oven will not run. | <ul style="list-style-type: none">• You are using the oven as a timer. Touch STOP/CLEAR to cancel the Kitchen Timer.• The door is not firmly closed and latched.• You did not touch START.• You did not follow directions exactly.• An operation that you set earlier is still running. Touch STOP/CLEAR to cancel that operation. |

COOKING TIMES

| PROBLEM | CAUSE |
|---|--|
| Food is not cooked enough. | <ul style="list-style-type: none">• The electric supply to your home or wall outlets is low or lower than normal. Your electric company can tell you if the line voltage is low. Your electrician or service technician can tell you if the outlet voltage is low.• The cook power is not at the recommended setting. Check the chart on Page 16. |
| The display shows a time counting down but the oven is not cooking. | <ul style="list-style-type: none">• The oven door is not closed completely.• You have set the controls as a kitchen timer. Touch STOP/CLEAR to cancel the Kitchen Timer. |

GLASS TRAY

| PROBLEM | CAUSE |
|-------------------------------|---|
| The glass tray will not move. | <ul style="list-style-type: none"> • The glass tray is not correctly in place. It should be correct-side up and sitting firmly on the center hub. • The support is not operating correctly. Remove the glass tray and restart the oven. If the hub still does not move, call Sears Service at 1-800-4-MY-HOME®. Cooking without the glass tray can give you poor results. |

TONES

| PROBLEM | CAUSE |
|---|---|
| You do not hear the programming or end-of-cycle tone. | <ul style="list-style-type: none"> • You have not entered the correct command. |

DISPLAY MESSAGES

| PROBLEM | CAUSE |
|------------------------------|---|
| The display is flashing “:.” | <ul style="list-style-type: none"> • There has been a power interruption. Reset the clock. (See the “Clock” section on Page 12.) |

If none of these items are causing your problem, call Sears Service at 1-800-4-MY-HOME®.