



Website: <http://us.lgservice.com>



# MICROWAVE OVEN

## OWNER'S MANUAL & COOKING GUIDE

PLEASE READ THIS OWNER'S MANUAL  
THOROUGHLY BEFORE OPERATING.

**LMV1630WW**

**LMV1630BB**

**LMV1630ST**

P/NO.: 3828W5A8536



**Thank you for purchasing a LG microwave oven.**

Please record the model number and serial number of this unit for future reference. We also suggest you record the details of your contact with LG (LG Electronics U.S.A., Inc.) concerning this unit.

Model No: \_\_\_\_\_

Serial No: \_\_\_\_\_

Dealer: \_\_\_\_\_

Dealer Phone No: \_\_\_\_\_

Staple your receipt here to prove your retail purchase.

Customer Relations  
LG Electronics U.S.A., Inc.  
Service Division Bldg. #3  
201 James Record Rd.  
Huntsville, AL 35824-0126

**PRECAUTIONS TO AVOID POSSIBLE  
EXPOSURE TO EXCESSIVE  
MICROWAVE ENERGY...**

- (a) Do not attempt to operate this oven with the door open since open-door operation can result in harmful exposure to microwave energy. It is important not to defeat or tamper with the safety interlocks.
- (b) Do not place any object between the oven front face and the door or allow soil or cleaner residue to accumulate on sealing surfaces.
- (c) Do not operate the oven if it is damaged. It is particularly important that the oven door closes properly and that there is no damage to the:
  - (1) Door (bent),
  - (2) Hinges and latches (broken or loosened),
  - (3) Door seals and sealing surfaces.
- (d) The oven should not be adjusted or repaired by anyone except properly qualified service personnel.

# TABLE OF CONTENTS

<b>PRECAUTIONS TO AVOID POSSIBLE EXPOSURE TO EXCESSIVE MICROWAVE ENERGY</b> .....	2	Popcorn Table .....	14
<b>TABLE OF CONTENTS</b> .....	3	Hot Warter .....	14
<b>SAFETY</b> .....	4	Hot Warter Table .....	14
Important Safety Instructions .....	4	Auto Cook .....	15
<b>INFORMATION</b> .....	6	Auto Cook Table .....	15
Location of Model Number .....	6	Cooking Guide for Auto Cook .....	15
Oven Specifications .....	6	Auto Reheat .....	16
Electrical Rating .....	6	Auto Reheat Table .....	16
Electrical Requirements .....	6	Cooking Guide for Auto Reheat .....	16
Grounding Instructions .....	6	Auto Defrost .....	17
Microwave Oven Features .....	7	Defrosting Tips .....	17
Oven Control Panel.....	8	Defrost Chart.....	18
<b>OPERATION</b> .....	10	<b>COOKING</b> .....	20
<b>LEARN ABOUT YOUR MICROWAVE OVEN</b> .....	10	<b>GETTING THE BEST COOKING RESULTS</b> .....	20
Clock .....	10	<b>FISH &amp; SHELLFISH</b> .....	20
Kitchen Timer .....	10	Cooking Fish and Shellfish: General Directions .....	20
VENT Hi/Low/Off .....	10	Fish And Shellfish Cooking Table .....	20
LIGHT Hi/Low/Off .....	10	<b>APPETIZERS / SAUCES / SOUPS</b> .....	21
TurnTable On/Off .....	10	Cooking Appetizers: Tips and Techniques.....	21
Child Lock .....	10	<b>MEAT</b> .....	21
Ez-On .....	11	Cooking Meat: General Directions .....	21
Cooking at High Cook Power .....	11	Meat Cooking Table .....	22
Cooking at Lower Power Levels.....	11	<b>POULTRY</b> .....	23
<b>MORE/LESS</b> .....	11	Cooking Poultry: General Directions .....	23
Cook Time .....	12	Poultry Cooking Table.....	23
Cooking Guide for Lower Power Levels .....	12	<b>PASTA AND RICE</b> .....	24
Hold Warm .....	13	Cooking Pasta and Rice: Tips and Techniques.....	24
Quick Defrost .....	13	Pasta Cooking Table.....	24
Melt .....	13	Rice Cooking Table.....	24
Soften .....	13	<b>MAINTENANCE</b> .....	25
Melt Table .....	14	<b>CARE AND CLEANING</b> .....	25
Soften Table .....	14	Cleaning the Grease Filters .....	25
Kids Meal .....	14	Charcoal Filter(Optional) Replacement .....	25
Kids Meal Table .....	14	Cooktop/Night Light Replacement .....	26
Popcorn .....	14	Oven Light Replacement .....	26
		<b>QUESTIONS AND ANSWERS</b> .....	26
		<b>MICROWAVE UTENSIL GUIDE</b> .....	27
		<b>BEFORE CALLING FOR SERVICE</b> .....	28
		<b>WARRANTY</b> .....	29

# SAFETY

## IMPORTANT SAFETY INSTRUCTIONS

The safety instructions below will tell you how to use your oven and avoid harm to yourself or damage to your oven.

**▲ WARNING** - To reduce the risk of burns, electric shock, fire, injury to persons, or exposure to excessive microwave energy.

- **Read all the instructions before using your oven.**
- **Do not allow children to use this oven without close supervision.**
- Read and follow the specific **PRECAUTIONS TO AVOID POSSIBLE EXPOSURE TO EXCESSIVE MICROWAVE ENERGY** found on page 2.
- **Do not use** corrosive chemicals or vapors, such as sulfide and chloride, in this appliance. This type of oven is specifically designed to heat, cook, or dry food. It is not designed for industrial or laboratory use.
- **Do not store** this appliance outdoors. Do not use this product near water - for example, near a kitchen sink, in a wet basement, near a swimming pool, or similar location.
- **Do not use** the cavity for storage purposes. Do not leave paper products, cooking utensils, or food in the cavity when not in use.
- **Clean the ventilating hood frequently.** Do not allow grease to accumulate on the hood or the filters.
- Use care when cleaning the vent hood filters. Corrosive cleaning agents such as lye-based oven cleaners may damage the filters.
- **Do not tamper with the built-in safety switches on the oven door.** The oven has several built-in safety switches to make sure the power is off when the door is open.
- When food flames under the hood, turn the fan on.
- Suitable for use above both gas and electric cooking equipment 36 inches wide or less.
- **Do not use this oven for commercial purposes.** It is made for household use only.
- **When cleaning the door and the surfaces that touch the door, use only mild, non-abrasive soaps or detergents and a sponge or soft cloth.**
- **If your oven is dropped or damaged,** have it thoroughly checked by a qualified service technician before using it again.
- **To avoid a fire hazard:**
  - **Do not severely overcook food.** Severely overcooked foods can start a fire in the oven. Watch the oven carefully, especially if you have paper, plastic, or other combustibles in the oven.
  - **Do not store combustible items (bread, cookies, etc.) in the oven,** because if lightning strikes the power lines it may cause the oven to turn on.
  - **Do not use wire twist-ties in the oven.** Be sure to inspect purchased items for wire twist-ties and remove them before placing the item in the oven.
- **If a fire should start:**
  - **Keep the oven door closed.**
  - **Turn the oven off.**
  - **Disconnect the power cord or shut off the power at the fuse or circuit breaker panel.**
- **To avoid electric shock:**
  - **This appliance must be grounded.** Connect it only to a properly grounded outlet. See the electrical **GROUNDING INSTRUCTIONS** on page 6.
  - **Do not operate this appliance if it has a damaged cord or plug,** if it is not working properly or if it has been damaged or dropped.
  - **Do not immerse the electrical cord or plug in water.**
  - **Keep the cord away from heated surfaces.**

# SAFETY

- **To avoid improperly cooking some foods.**
  - **Do not heat any types of baby bottles or baby food.** Uneven heating may occur and possibly cause personal injury.
  - **Do not heat small-necked containers,** such as syrup bottles.
  - **Do not deep-fat fry in your microwave oven.**
  - **Do not attempt home canning in your microwave oven.**
  - **Do not heat the following items in the microwave oven:** whole eggs in the shell, water with oil or fat, sealed containers, or closed glass jars. These items may explode.
- Do not cover or block any openings in the oven.
- Use your oven only for the operations described in this manual.
- Do not run the oven empty, without food in it.
- Do not let cord hang over edge of table or counter.
- **Preserve the oven floor:**
  - **Do not heat the oven floor excessively.**
  - **Do not** allow the gray film on special microwave-cooking packages to touch the oven floor. Put the package on a microwavable dish.
  - **Do not** cook anything directly on the oven floor or turntable. Use a microwavable dish.
  - Keep a browning dish at least 3/16 inch above floor. Carefully read and follow the instructions for the browning dish. If you use a browning dish incorrectly, you could damage the oven floor.
- Install or locate this appliance only in accordance with the provided installation instructions.
- This appliance should be serviced only by qualified service personnel. Contact the nearest authorized service facility for examination, repair, or adjustment.
- Liquids, such as water, coffee, or tea are able to be overheated beyond the boiling point without appearing to be boiling. Visible bubbling or boiling when the container is removed from the microwave oven is not always present.

THIS COULD RESULT IN VERY HOT LIQUIDS SUDDENLY BOILING OVER WHEN THE CONTAINER IS DISTURBED OR A SPOON OR OTHER UTENSIL IS INSERTED INTO THE LIQUID. To reduce the risk of injury to persons;

  - Do not overheat the liquid.
  - Stir the liquid both before and halfway through heating it.
  - Do not use straight-sided containers with narrow necks.
  - After heating, allow the container to stand in the microwave oven for a short time before removing the container.
  - Use extreme care when inserting a spoon or other utensil into the container.

## SAVE THESE INSTRUCTIONS

### FEDERAL COMMUNICATIONS COMMISSION RADIO FREQUENCY INTERFERENCE STATEMENT ( U.S.A. ONLY)

#### **WARNING:**

This equipment generates and uses ISM frequency energy and if not installed and used properly, that is in strict accordance with the manufacturer's instructions, may cause interference to radio and television reception. It has been type tested and found to comply with limits for ISM Equipment pursuant to part 18 of FCC Rules, which are designed to provide reasonable protection against such interference in a residential installation.

However, there is no guarantee that interference will not occur in a particular installation. If this equipment does cause interference to radio or television reception, which can be determined by turning the equipment off and on, the user is encouraged to try to correct the interference by one or more of the following:

- Reorient the receiving antenna of the radio or television.
- Relocate the Microwave Oven with respect to the receiver.
- Move the microwave oven away from the receiver.
- Plug the microwave oven into a different outlet so that the microwave oven and the receiver are on different branch circuits.

**The manufacturer** is not responsible for any radio or TV interference caused by **unauthorized modification** to this microwave oven. It is the responsibility of the user to correct such interference.

# INFORMATION

Please read this owner's manual. It will tell you how to use all the fine features of this microwave oven.

## LOCATION OF MODEL NUMBER

To request service information or replacement parts, the service center will require the complete model number of your microwave oven. The number is on the left side of control panel as shown in the illustration below.

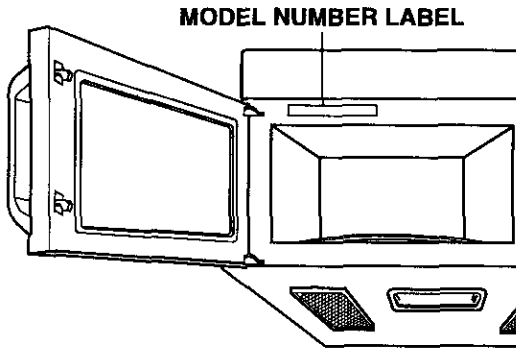

## OVEN SPECIFICATIONS

Output Power 1,000W (IEC 60705 Standard)  
Outer Dimensions 29-15/16" x 16-7/16" x 17-1/8"  
Cavity Volume 1.6 Cu.ft  
Net Weight 52 lbs.

## ELECTRICAL RATING

\* Electrical Rating of the Oven: 120V AC 60Hz  
\* 14 Amps / 1500 Watts ( MWO + Cooktop Lamp + Ventilation Fan)

## ELECTRICAL REQUIREMENTS

The oven is designed to operate on a Standard 120V/60Hz household outlet. Be sure the circuit is at least 15A or 20A and the microwave oven is the **only appliance on the circuit**. It is not designed for 50Hz or any circuit other than a 120V/60Hz circuit.

## GROUNDING INSTRUCTIONS

**This appliance must be grounded.** If an electrical short circuit occurs, grounding reduces the risk of electric shock by providing an escape wire for the electric current. The cord for this appliance has a grounding wire with a grounding plug. Put the plug into an outlet that is properly installed and grounded.

**WARNING - If you use the grounding plug improperly, you risk electric shock.**

Ask a qualified electrician if you do not understand the grounding instructions or if you wonder whether the appliance is properly grounded.

Because this appliance fits under the cabinet, it has a short power-supply cord. See the separate Installation Instructions for directions on properly placing the cord. Keep the electrical power cord dry and do not pinch or crush it in any way.

If it is necessary to use an extension cord, use only a 3-wire extension cord that has a 3-blade grounding plug, and a 3-slot receptacle that will accept the plug on the appliance. The marked rating of the extension cord shall be equal to or greater than the electrical rating of the appliance.

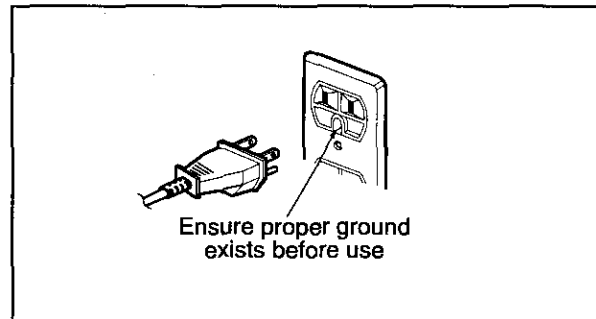

For a permanently connected appliance:  
This appliance must be connected to a grounded, metallic, permanent wiring system, or an equipment grounding conductor should be run with the circuit conductors and connected to the equipment grounding terminal or lead on the appliance.

# INFORMATION

## MICROWAVE OVEN FEATURES

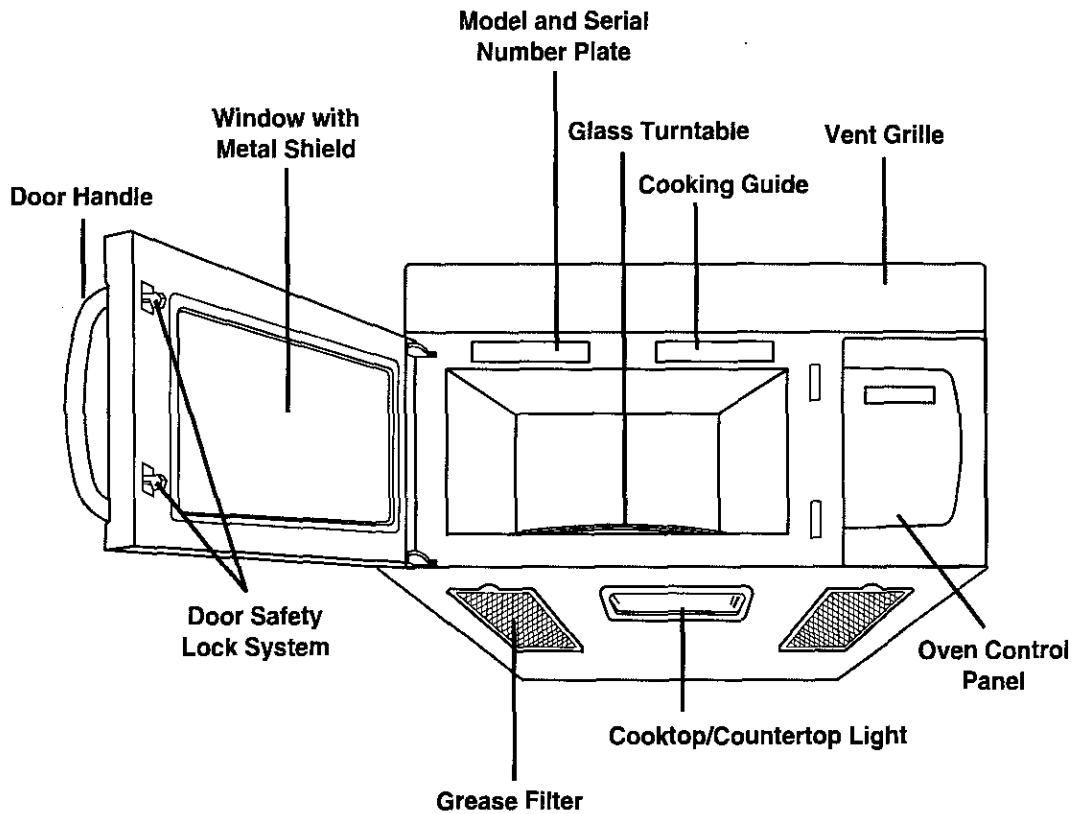

# INFORMATION

## OVEN CONTROL PANEL

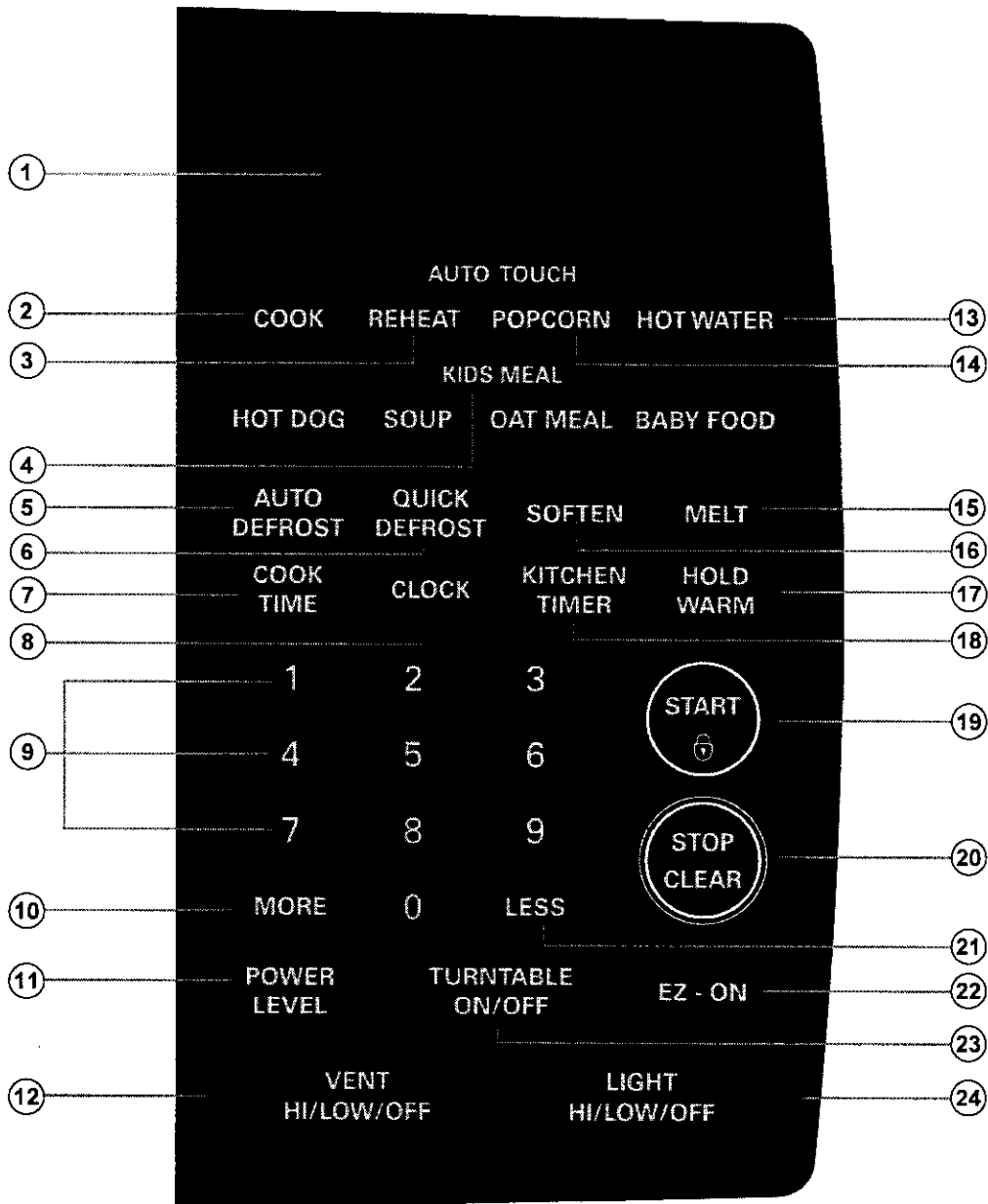



# INFORMATION

- 1. DISPLAY:** The Display includes a clock and indicators to tell you time of day, cooking time settings and cooking functions selected.
- 2. COOK:** Touch this pad to cook fresh vegetable, frozen vegetable, rice, or casseroles.
- 3. REHEAT:** Touch this pad to reheat dinner plate, soup/sauce, casserole, roll/muffin.
- 4. KIDS MEAL:** Selects type of dish to reheat hot dog, baby food, oat meal or soup.
- 5. AUTO DEFROST:** Meat ,poultry, fish. Touch this pad to select food type and defrost food by weight.
- 6. QUICK DEFROST:** This pad provides you with the RAPID defrosting method for 1.0 pound frozen foods.
- 7. COOK TIME:** Touch this pad to set a cooking time.
- 8. CLOCK:** Touch this pad to enter the time of day.
- 9. NUMBER:** Touch number pads to enter cooking time, power level, quantities or weights.
- 10. MORE:** Touch this pad to add ten seconds of cooking time each time you press it.
- 11. POWER LEVEL:** Touch this pad to select a cooking power level.
- 12. VENT HI/LOW/OFF:** Touch this pad to turn the Vent on or off.
- 13. HOT WATER:** Touch this pad when heating water in your microwave oven.
- 14. POPCORN:** Touch this pad when popping popcorn in your microwave oven.
- 15. MELT:** Touch this pad to melt butter or margarine, chocolate, cheese, marsh mallow.
- 16. SOFTEN:** Touch this pad to soften butter, ice cream, cream cheese, frozen juice.
- 17. HOLD WARM:** Touch this pad to keep hot, cooked foods warm in your microwave oven for up to 99 minutes 99 seconds.
- 18. KITCHEN TIMER:** Touch this pad to set the kitchen timer.
- 19. START:** Touch this pad to start a function. If you open the door after oven begins to cook, retouch START.
- 20. STOP/CLEAR:** Touch this pad to stop the oven or clear all entries.
- 21. LESS:** Touch this pad to subtract ten seconds of cooking time each time you press it.
- 22. EZ - ON:** Touch this pad to set and start quickly at 100% power level.
- 23. TURNTABLE ON/OFF:** Touch this pad to control the turntable on or off.
- 24. LIGHT HI/LOW/OFF:** Touch this pad to turn the cooktop/countertop light on or off.

# OPERATION

## LEARN ABOUT YOUR MICROWAVE OVEN

This section discusses the concepts behind microwave cooking and introduces you to the basics you need to know to operate your microwave oven. Please read this information before use.

### CLOCK

**Example: To set 8:00 AM.**



	1. Touch <b>STOP/CLEAR</b>
<b>CLOCK</b>	2. Touch <b>CLOCK</b>
<b>8 0 0</b>	3. Enter the time by using the number key pad.
<b>CLOCK</b>	4. Touch <b>CLOCK</b> (or <b>START</b> )

**NOTE:** Touch **CLOCK** twice to set PM time.

### KITCHEN TIMER

You can use your microwave oven as a timer. Use the Timer for timing up to 99 minutes, 99 seconds.

**Example: To count 3 minutes.**

	1. Touch <b>STOP/CLEAR</b> .
<b>KITCHEN TIMER</b>	2. Touch <b>KITCHEN TIMER</b> .
<b>3 0 0</b>	3. Enter the time by using the number key pad.
	4. Touch <b>START</b> . When the time is over, you will hear seven beeps and <b>END</b> will display.

### VENT HI/LOW/OFF

**VENT HI/LOW/OFF** The VENT moves steam and other vapors from the surface cooking. Touch VENT once for High fan speed, twice for Low fan speed, or a three times to turn the fan off.

**NOTE:** If the temperature gets too hot around the microwave oven, the fan in the vent hood will automatically turn on at the LOW setting to cool the oven. It may stay on up to an hour to cool the oven. When this occurs, **you can not turn the fan off manually.**

### LIGHT HI/LOW/OFF

**LIGHT HI/LOW/OFF** Touch LIGHT once for bright light, twice for the night light or three times to turn the light off.



### TURNTABLE ON/OFF

**TURNTABLE ON/OFF** Touch Turntable On/Off once to turn Turntable on, twice to turn off.

### CHILD LOCK

You may lock the control panel to prevent the microwave from being accidentally started or used by children.

**Example: To set the child lock.**

	1. Touch <b>STOP/CLEAR</b> .
	2. Touch and hold <b>START</b> more than 4 seconds. L will appear in the display window with two beeps.

**Example: To cancel the child lock.**

	1. Touch and hold <b>START</b> more than 4 seconds. L will disappear and you hear two beeps. At this time the oven is ready.
---	--

# OPERATION

## EZ - ON

A time-saving pad, this simplified control lets you quickly set and start microwave cooking without the need to touch **START**.

**Example: To cook for 2 minutes.**

**EZ - ON**

Touch **EZ - ON** 4 times. The oven begins cooking and display shows time counting down.

### NOTE:

If you touch **EZ - ON**, it will add 30 seconds up to 3 minutes. After 3 minutes, every touch will add 1 minute up to 99 min 59 seconds.

## COOKING AT HIGH COOK POWER

**Example: To cook food for 8 minutes 30 seconds at 100% power.**



1. Touch **STOP/CLEAR**.

**8 3 0**

2. Enter the cook time.



3. Touch **START**.

When the cook time is over, you will hear four beeps and **END** will display.

## COOKING AT LOWER POWER LEVELS

HIGH power cooking does not always give you the best results with foods that need slower cooking, such as roasts, baked goods, or custards. Your oven has 9 power settings in addition to "HIGH".

**Example: To cook food for 7 minutes 30 seconds at 70% power.**



1. Touch **STOP/CLEAR**.

**7 3 0**

2. Enter the cook time.

**POWER LEVEL**

3. Touch **POWER LEVEL**.

**7**

4. Enter the power level.



5. Touch **START**.  
When the cook time is over, you will hear four beeps and **END** will display.

## MORE/LESS

By using the More or Less keys, all of the preprogrammed cook and time cook features can be adjusted to cook food for a longer or shorter time.

**Example**

**MORE**

1. Pressing **MORE** will add 10 seconds of cooking time each time you press it.

**LESS**



2. Pressing **LESS** will subtract 10 seconds of cooking time each time you press it.

# OPERATION

## COOK TIME

For best results, some recipes call for different cook powers during different stages of a cook cycle. You can program your oven to switch from one power level to another for up to 2 stages.

**Example: To cook for 2 minutes with 70% power in the first stage and cook for 5 minutes with 80% power in the second stage.**

	1. Touch <b>STOP/CLEAR</b> .
<b>COOK TIME</b>	2. Touch <b>COOK TIME</b> .
<b>2 0 0</b>	3. Enter the cook time.
<b>POWER LEVEL</b>	4. Touch <b>POWER LEVEL</b> .
<b>7</b>	5. Select 70% power level.
<b>COOK TIME</b>	6. Touch <b>COOK TIME</b> .
<b>5 0 0</b>	7. Enter the cook time.
<b>POWER LEVEL</b>	8. Touch <b>POWER LEVEL</b> .
<b>8</b>	9. Select 80% power level.
	10. Touch <b>START</b> .

## COOKING GUIDE FOR LOWER POWER LEVELS

The nine power levels in addition to "HIGH" allow you to choose the best power level for the food you are cooking.

POWER LEVEL	MICROWAVE OUTPUT	USE
10 "HIGH"	100%	<ul style="list-style-type: none"> <li>Boil water.</li> <li>Cook ground beef.</li> <li>Make candy.</li> <li>Cook fresh fruits and vegetables.</li> <li>Cook fish, and poultry.</li> <li>Preheat browning dish.</li> </ul>
9	90%	<ul style="list-style-type: none"> <li>Reheat meat slices quickly.</li> <li>Saute onions, celery, and green pepper.</li> </ul>
8	80%	<ul style="list-style-type: none"> <li>All reheating.</li> <li>Cook scrambled eggs.</li> <li>Cook breads and cereal products.</li> <li>Cook cheese dishes, veal.</li> </ul>
7	70%	<ul style="list-style-type: none"> <li>Cook cakes, muffins, brownies cup cakes.</li> <li>Cook pasta.</li> </ul>
6	60%	<ul style="list-style-type: none"> <li>Cook meats, whole poultry.</li> <li>Cook custard.</li> <li>Cook whole chicken, turkey, spare ribs, rib roast, sirloin roast.</li> </ul>
5	50%	<ul style="list-style-type: none"> <li>Cook less tender cuts of meat.</li> <li>Reheat frozen convenience foods.</li> </ul>
4	40%	<ul style="list-style-type: none"> <li>Thawing meat, poultry, and seafood.</li> </ul>
3	30%	<ul style="list-style-type: none"> <li>Cooking small quantities of food.</li> <li>Finish cooking casserole, stew, and some sauces.</li> </ul>
2	20%	<ul style="list-style-type: none"> <li>Soften butter and cream cheese.</li> <li>Heating small amounts of food.</li> </ul>
1	10%	<ul style="list-style-type: none"> <li>Soften ice cream.</li> <li>Raise yeast dough.</li> </ul>
0		<ul style="list-style-type: none"> <li>Standing time.</li> </ul>

# OPERATION

## HOLD WARM

You can keep cooked food warm in your microwave oven for up to 99 minutes 99 seconds. You can use **HOLD WARM** by itself or to follow a cooking cycle automatically.

### Example: To use the hold warm.



1. Touch **STOP/CLEAR**.

**HOLD WARM**

2. Touch **HOLD WARM**.



3. Touch **START**.

### NOTE:

- **HOLD WARM** operates for up to 99 minutes 99 seconds.
- Food cooked covered should be covered during **HOLD WARM**
- Pastry items (pies, turnovers, etc.) should be uncovered during **HOLD WARM**.
- Complete meals kept warm on a dinner plate can be covered during **HOLD WARM**.

Food Type	Recommended Quantity
Liquid	1-2 cups
Dry	5-10 ozs.

To make **HOLD WARM** automatically follow another cycle:

- While you are programming the cooking instructions, touch **HOLD WARM** before touching **START**.
- When the last cooking cycle is over, you will hear two tones and **HOLD WARM** will appear in the oven display.
- You can set **HOLD WARM** to follow **AUTO DEFROST**, or multi-cycle cooking.

## QUICK DEFROST

### Example: To defrost 1lb ground beef.

**QUICK DEFROST**

1. Touch **QUICK DEFROST**.

**NOTE:** The oven will start automatically.

## MELT

Melt provides four preset categories for melt. Butter, Chocolate, Cheese, Marshmallows.

### Example: To Melt 16 oz Cheese.



1. Touch **STOP/CLEAR**.

**MELT**

2. Touch **MELT** pad three times.

**2**

3. Choose 16 oz.



4. Touch **START**.

**NOTE:** After 4 seconds, the oven will start automatically. When the cook time is over, you will hear four beeps and **END** will display.

## SOFTEN

Soften provides four preset categories for melt. Butter, Ice Cream, Cream Cheese, Frozen Juice.

### Example: To Soften 3 oz Cream Cheese.



1. Touch **STOP/CLEAR**.

**SOFTEN**

2. Touch **SOFTEN** pad three times.

**1**

3. Choose 3 oz.



4. Touch **START**.

**NOTE:** After 4 seconds, the oven will start automatically. When the cook time is over, you will hear four beeps and **END** will display.

# OPERATION

## MELT TABLE

Category	Touch pad times	Touch pad number		
		1	2	3
Butter	1	1 stick	2 sticks	3 sticks
Chocolate	2	4 oz	8 oz	-
Cheese	3	8 oz	16 oz	-
Marshmallows	4	5 oz	10 oz	-

## SOFTEN TABLE

Category	Touch pad times	Touch pad number		
		1	2	3
Butter	1	1 stick	2 sticks	3 sticks
Ice Cream	2	pint	quart	half gallon
Cream Cheese	3	3 oz	8 oz	-
Frozen Juice	4	6 oz	12 oz	16 oz

## KIDS MEAL

Using **KIDS MEAL** lets you heat common microwave-prepared foods without needing to program times and cook power.

Hot Dog, Baby Food, Oat Meal, Soup.

### Example: To heat 4 ea Hot Dogs.



1. Touch **STOP/CLEAR**.

**HOT DOG**

2. Touch **HOT DOG** twice.



4. Touch **START**.

**NOTE:** After 4 seconds, the oven will start automatically. When the cook time is over, you will hear four beeps and **END** will display.

## KIDS MEAL TABLE

Category	Touch pad times		
	1	2	3
Hot Dog	2 ea	4 ea	-
Baby Food	4 oz	8 oz	16 oz
Oat Meal	4 oz	8 oz	16 oz
Soup	4 oz	8 oz	16 oz

## POPCORN

**POPCORN** lets you pop 3.0, and 3.5 ounce bags of commercially packaged microwave popcorn. Pop only one package at a time. If you are using a microwave popcorn popper, follow manufacturer's instructions.

## POPCORN TABLE

Bag size-ounces	3.5	3.0
Touch pad times	1	2

### Example: To pop a 3.5 oz. bag.



1. Touch **STOP/CLEAR**.

**POPCORN**

2. Touch **POPCORN**.



3. Touch **START**.

**NOTE:** After 4 seconds, the oven will start automatically. When the cook time is over, you will hear four beeps and **END** will display.

**CAUTION:** Do not leave microwave unattended while popping popcorn.

## HOT WATER

Use this pad to heat water. You can choose 1 or 2 cups

### Example: To use the hold warm for 1 cup.



1. Touch **STOP/CLEAR**.

**HOT WATER**

2. Touch **HOT WATER**.



3. Touch **START**.

**NOTE:** After 4 seconds, the oven will start automatically. When the cook time is over, you will hear four beeps and **END** will display.

## HOT WATER TABLE

Quantity	1 cup	2 cups
Touch pad times	1	2

# OPERATION

## AUTO TOUCH

This function lets you cook foods without needing to program times and cook power.

## AUTO COOK

AUTO COOK provides four categories for cooking.

## AUTO COOK TABLE

**Example: To cook 2 cups of Rice.**



1. Touch **STOP/CLEAR**.

**COOK**

2. Touch **COOK** pad three times.

**2**

3. Enter quantity/servings.



4. Touch **START**.

**NOTE:** After 4 seconds, the oven will start automatically. When the cook time is over, you will hear four beeps and **END** will display.

Category	Touch pad times	Touch pad number			
		1	2	3	4
Fresh Vegetable	1	1 cup	2 cups	3 cups	4 cups
Frozen Vegetable	2	1 cup	2 cups	3 cups	4 cups
Rice	3	1 cup	2 cups	–	–
Casserole	4	1 cup	2 cups	3 cups	4 cups

## COOKING GUIDE FOR AUTO COOK

CODE	CATEGORY	QUANTITY	DIRECTIONS
1	FRESH VEGETABLE	1 cup Vegetables and 2 tbsp water	Place in a microwavable bowl or casserole. Add amount of water according to the quantity. Cover with vented plastic wrap. Let stand 5 minutes.
		2 cups Vegetables and 1/4 cup of water	
		3 cups Vegetables and 1/3 cup of water	
		4 cups Vegetables and 1/2 cup of water	
2	FROZEN VEGETABLE	1 cup	Place in a microwavable bowl or casserole. Cover with vented plastic wrap. Let stand 5 minutes.
		2 cups	
		3 cups	
		4 cups	
3	RICE	1 cup of Long grain rice and 2 1/4 cup of water	In large microwavable casserole, combine water, rice, margarine and salt. Cover with microwavable lid or vented plastic wrap. After cooking, let stand covered for 5 minutes.
		2 cups of Long grain rice and 4 1/4 cup of water	
4	CASSEROLE	1 cup	Place in a microwavable bowl or casserole. Cover with vented plastic wrap.
		2 cups	
		3 cups	
		4 cups	

# OPERATION

## AUTO REHEAT

AUTO REHEAT provides four preset categories.

**Example: To reheat 3 cups of Casserole.**

 1. Touch **STOP/CLEAR**.

**REHEAT** 2. Touch **REHEAT** pad four times.

**3** 3. Enter quantity/servings.

 4. Touch **START**.

**NOTE:** After 4 seconds, the oven will start automatically. When the cook time is over, you will hear four beeps and **END** will display.

## AUTO REHEAT TABLE

Category	Touch pad times	Touch pad number			
		1	2	3	4
Dinner Plate	1	1 serving	2 servings	-	-
Soup Sauce	2	1 cup	2 cups	3 cups	4 cups
Casserole	3	1 cup	2 cups	3 cups	4 cups
Roll Muffin	4	1 piece	2 pieces	3 pieces	4 pieces

## COOKING GUIDE FOR AUTO REHEAT

CODE	CATEGORY	SERVING AMOUNT	DIRECTION
1	DINNER PLATE	1 serving	Place on a low plate. Cover with vented plastic wrap.
		2 servings	
2	SOUP/SAUCE	1 cup	Place in shallow microwavable casserole. Cover with vented plastic wrap.
		2 cups	
		3 cups	
		4 cups	
3	CASSEROLE	1 cup	Place in a microwavable bowl or casserole. Cover with plastic wrap.
		2 cups	
		3 cups	
		4 cups	
4	ROLL/MUFFIN	1 piece	Place on paper towel. Do not cover.
		2 pieces	
		3 pieces	
		4 pieces	



# OPERATION

## AUTO DEFROST

Three defrost choices are preset in the oven. The defrost feature provides you with the best defrosting method for frozen foods, because the oven automatically sets the defrosting times for each food item according to the weight you enter. For added convenience, the **AUTO DEFROST** includes a built-in tone mechanism that reminds you to check, turn over, separate, or rearrange the food during the defrost cycle. Three different defrosting options are provided.

1. **MEAT**
2. **POULTRY**
3. **FISH**

After touching **AUTO DEFROST** once, select the food category. Available weight ranges for Meat, Poultry and Fish are 0.1 to 6.0 lbs.

**Example: To defrost 1.2 lbs of meat.**

<b>AUTO DEFROST</b>	1. Touch <b>AUTO DEFROST</b> .
<b>1 2</b>	2. Enter the weight.
	3. Touch <b>START</b> .

### NOTE:

- After you touch **START**, the display counts down the defrost time. The oven will beep once during the defrost cycle. At this time, open the door and turn, separate, or rearrange the food as needed. Remove any portions that have thawed then return frozen portions to the oven and touch **START** to resume the defrost cycle.
- The oven will not stop during the beep unless the door is opened.

## WEIGHT CONVERSION CHART

To enter food weight in **AUTO DEFROST**, you must specify pounds and tenths of a pound. If the weight on the food package is in fractions of a pound, you can use the following chart to convert the weight to decimals.

EQUIVALENT OUNCE WEIGHT	NUMBER AFTER DECIMAL
1.6	.10
3.2	.20
4.0	.25 One-Quarter Pound
4.8	.30
6.4	.40
8.0	.50 One- Half Pound
9.6	.60
11.2	.70
12.0	.75 Three-Quarters Pound
12.8	.80
14.4	.90
16.0	1.00 One Pound

## DEFROSTING TIPS

- When using **AUTO DEFROST**, the weight to be entered is the net weight in pounds and tenths of pounds (the weight of the food minus the container).
- Use **AUTO DEFROST** only for raw food. **AUTO DEFROST** gives best results when food to be thawed is a minimum of 0 F (taken directly from a true freezer). If food has been stored in a refrigerator-freezer that does not maintain a temperature of 5F or below, always program a lower food weight (for a shorter defrosting time) to prevent cooking the food.
- If the food is stored outside the freezer for up to 20 minutes, enter a lower food weight.
- The shape of the package alters the defrosting time. Shallow rectangular packets defrost more quickly than a deep block.
- Separate pieces as they begin to defrost. Separated pieces defrost more easily.
- You can use small pieces of aluminum foil to shield shieldfoods like chicken wings, leg tips, and fish tails but the foil must not touch the side of the oven. Foil causes arcing, which can damage the oven lining.
- Shield areas of food with small pieces of foil if they start to become warm.
- For even, complete defrosting, use the defrosting rack.
- For best results, elevate food to be defrosted on a microwave safe roasting rack. This prevents the possibility of warm meat juices cooking food during defrost.

# OPERATION

## DEFROST CHART

### Meat setting

FOOD	SETTING	AT BEEP	SPECIAL INSTRUCTIONS
<b>BEEF</b>			Meat of irregular shape and large, fatty cuts of meat should have the narrow or fatty areas shielded with foil at the beginning of a defrost sequence.
Ground beef (bulk)	MEAT	Remove thawed portions with fork. Turn over. Return remainder to oven.	Do not defrost less than 1/4 lb. Freeze in doughnut shape.
Ground beef (patties)	MEAT	Separate and rearrange.	Do not defrost less than two oz. patties. Depress center when freezing.
Round steak	MEAT	Turn over. Cover warm areas with aluminum foil.	Place on a microwavable roasting rack.
Tenderloin steak	MEAT	Turn over. Cover warm areas with aluminum foil.	Place on a microwavable roasting rack.
Stew beef	MEAT	Remove thawed portions with fork. Separate remainder. Return remainder to oven.	Place in a microwavable baking dish.
Pot roast, chuck roast	MEAT	Turn over. Cover warm areas with aluminum foil.	Place on a microwavable roasting rack.
Rib roast	MEAT	Turn over. Cover warm areas with aluminum foil.	Place on a microwavable roasting rack.
Rolled rump roast	MEAT	Turn over. Cover warm areas with aluminum foil.	Place on a microwavable roasting rack.
<b>LAMB</b>			
Cubes for stew	MEAT	Remove thawed portions with fork. Return remainder to oven.	Place in a microwavable baking dish.
Chops (1 inch thick)	MEAT	Separate and rearrange.	Place on a microwavable roasting rack.
<b>PORK</b>			
Chops (1 inch thick)	MEAT	Separate and rearrange.	Place on a microwavable roasting rack.
Hot dogs	MEAT	Separate and rearrange.	Place on a microwavable roasting rack.
Spareribs Country style ribs	MEAT	Turn over. Cover warm areas with aluminum foil.	Place on a microwavable roasting rack.
Sausage, links	MEAT	Separate and rearrange.	Place on a microwavable roasting rack.
Sausage, bulk	MEAT	Remove thawed portions with fork. Turn over. Return remainder to oven.	Place in a microwavable baking dish.
Loin roast, boneless	MEAT	Turn over. Cover warm areas with aluminum foil.	Place on a microwavable roasting rack.

# OPERATION

## DEFROST CHART (continued)

### Poultry setting

FOOD	SETTING	AT BEEP	SPECIAL INSTRUCTIONS
<b>CHICKEN</b> Whole	POULTRY	Turn over (finish defrosting breast-side down). Cover warm areas with aluminum foil.	Place chicken breast-side-up on a microwavable roast rack. Finish defrosting by immersing in cold water. Remove giblets when chicken is partially defrosted.
		Cut-up	Turn over. Cover warm areas with aluminum foil. Separate pieces and rearrange.
<b>CORNISH HENS</b> Whole	POULTRY	Turn over. Cover warm areas with aluminum foil.	Place on a microwavable roasting rack. Finish defrosting by immersing in cold water.
<b>TURKEY</b> Breast	POULTRY	Turn over. Cover warm areas with aluminum foil.	Place on a microwavable roasting rack. Finish defrosting by immersing in cold water.

### Fish setting

FOOD	SETTING	AT BEEP	SPECIAL INSTRUCTIONS	
<b>FISH</b> Filletts	FISH	Turn over. Separate fillets when partially thawed if possible.	Place in a microwavable baking dish. Carefully separate fillets under cold water.	
		Steaks	Separate and rearrange.	Place in a microwavable baking dish. Run cold water over to finish defrosting.
		Whole		Place in a microwavable baking dish. Cover head and tail with foil; do not let foil touch sides of microwave. Finish defrosting by immersing in cold water.
<b>SHELLFISH</b> Crabmeat	FISH	Break apart.	Place in a microwavable baking dish.	
Lobster tails	FISH	Rearrange.	Place in a microwavable baking dish.	
Shrimp	FISH	Separate and rearrange.	Place in a microwavable baking dish.	
Scallops	FISH	Separate and rearrange.	Place in a microwavable baking dish.	

**NOTE :** Food to be defrosted must be not more than 6.0 lbs. (4.0kg)

\* Available weight is 0.1~6.0 lbs. (0.1~4.0kg)

# COOKING

## GETTING THE BEST COOKING RESULTS

To get the best results from your microwave oven, read and follow the guidelines below.

- **Storage Temperature:** Foods taken from the freezer or refrigerator take longer to cook than the same foods at room temperature. The time for recipes in this book is based on the normal storage temperature of the food.
- **Size:** Small pieces of food cook faster than large ones, pieces similar in size and shape cook more evenly. For even cooking, reduce the power when cooking large pieces of food.
- **Natural Moisture:** Very moist foods cook more evenly because microwave energy is attracted to water molecules.
- **Stir** foods such as casseroles and vegetables from the outside to the center to distribute the heat evenly and speed cooking. Constant stirring is not necessary.
- **Turn over** foods like pork chops, baking potatoes, roasts, or whole cauliflower halfway through the cooking time to expose all sides equally to microwave energy.
- **Place** delicate areas of foods, such as asparagus tips, toward the center of the dish.
- **Arrange** unevenly shaped foods, such as chicken pieces or salmon steaks, with the thicker, meatier parts toward the outside of the dish.
- **Shield**, with **Small** pieces of aluminum foil, parts of food that may cook quickly, such as wing tips and leg ends of poultry.
- **Let It Stand:** After you remove the food from the microwave, cover food with foil or casserole lid and let it stand to finish cooking in the center and avoid overcooking the outer edges. The length of standing time depends on the density and surface area of the food.
- **Wrapping in waxed paper or paper towel:** Sandwiches and many other foods containing prebaked bread should be wrapped prior to microwaving to prevent drying out.

## Fish & Shellfish

### Cooking Fish and Shellfish: General Directions

- Prepare the fish for cooking.
  - Completely defrost the fish or shellfish.
  - Arrange unevenly shaped pieces with thicker parts toward the outside of the dish. Arrange shellfish in a single layer for even cooking.
  - The type of cover you use depends on how you cook. Poached fish needs a microwavable lid or **vented** plastic wrap.
  - Baked fish, coated fish, or fish in sauce needs to be covered lightly with waxed paper to keep the coating crisp and sauce from getting watery.
- Always set the shortest cooking time. Fish is done when it turns opaque and the thickest part begins to flake. Shellfish is done when the shell turns from pink to red and the flesh is opaque and firm.
- The Fish and Shellfish Cooking Table below provides specific directions with Power Level and Cooking Time settings for most types of fish and shellfish.

### Fish And Shellfish Cooking Table

FISH	POWER LEVEL	COOKING TIME	DIRECTIONS
Fish fillets	HI	3 1/2-4 1/2 minutes	Arrange fish in a single layer with thickest portion toward outside edge of 1 1/2 quart microwavable baking dish. Brush with melted butter and season, if desired. Cook covered with vented plastic wrap. Let stand covered 2 minutes. If you are cooking more than 1 lb. of fish, turn the fish halfway through cooking.
Fish steaks	HI	4 1/2-5 1/2 minutes	
Whole fish	7	4 1/2-6 minutes	
Scallops	HI	3 1/2-5 minutes	Arrange in a single layer. Prepare as directed above, except stir instead of turning the shellfish.
Shrimp, shelled	HI	3 1/2-5 minutes	

# COOKING

## Appetizers / Sauces / Soups

### Cooking Appetizers: Tips and Techniques

#### Recommended

- crackers, such as melba toast, shredded wheat, and crisp rye crackers are best for microwave use. Wait until party time to add the spreads. Place a paper towel under the crackers while they cook in the microwave oven to absorb extra moisture.
- Arrange individual appetizers in a circle for even cooking.
- Stir dips to distribute heat and shorten cooking time.

#### Cooking Sauces: Tips and Techniques

- Use a microwavable casserole or glass measuring cup that is at least 2 or 3 times the volume of the sauce.
- Sauces made with cornstarch thicken more rapidly than those made with flour.

#### Cooking Soups: Tips and Techniques

- Cook soups in a microwavable dish which holds double the volume of the recipe ingredients to prevent boil-over, especially if you use cream or milk in the soup.
- Generally, cover microwaved soups with VENTED plastic wrap or a microwavable lid.
- Cover foods to retain moisture. Uncover foods to retain crispness.
- Avoid overcooking by using the minimum suggested time. Add more time, if necessary, only after checking the food.

#### Not Recommended

- Appetizers with a crisp coating or puff pastry are best done in a conventional oven with dry heat.
- Breaded products can be warmed in the microwave oven but will not come out crisp.
- Cook sauces made with cornstarch or flour uncovered so you may stir them 2 or 3 times during cooking for a smooth consistency.
- To adapt a conventional sauce or gravy recipe, reduce the amount of liquid slightly.
- Stirring occasionally will help blend flavors, distribute heat evenly, and may even shorten the cooking time.
- When converting a conventional soup recipe to cook in the microwave, reduce the liquid, salt, and strong seasonings.

## Meat

### Cooking Meat: General Directions

- Prepare the meat for cooking.
  - Defrost completely.
  - Trim off excess fat to avoid splattering.
  - Place the meat, fat side down, on a microwavable rack in a microwavable dish.
  - Use oven cooking bag for less tender cuts of meat.
  - Arrange the meat so that thicker portions are toward the outside of the dish.
  - Cover the meat with waxed paper to prevent splattering.
- Tend the meat as it cooks.
  - Drain juices as they accumulate to reduce splattering and keep from overcooking the bottom of the meat.
  - Shield thin or bony portions with strips of foil to prevent overcooking.

**NOTE:** Keep the foil at least 1 inch from the oven walls, and do not cover more than one-third of the meat with foil at any one time.

- Let the meat stand covered with foil 10-15 minutes after you remove it from the oven. The internal temperature of the meat may rise from 5-10°F during standing time.

The Meat Cooking Table on the next page provides detailed directions, Power Level, and Cooking Time settings for most cuts of meat.

# COOKING

## Meat Cooking Table

MEAT	POWER LEVEL	COOKING TIME	DIRECTIONS
Beef Hamburgers, Fresh or defrosted (4 oz. each) 1 patty 2 patties 4 patties	HI	1-1½ minutes 1½-2 minutes 2½-3½ minutes	Form patties with depression in center of each. Place on microwavable roast rack. Brush with browning agent, if desired. Cover with waxed paper. Turn over halfway through cooking. Let stand covered 1 minute.
Sirloin tip roast (3-4 lbs.)	5	8-10 minutes per pound RARE(135°F) 11-13 minutes per pound MEDIUM(155°F)	Place roast fat side down on microwavable roast rack. Add desired seasonings and cover with waxed paper. Turn meat over halfway through cooking and shield if necessary. Remove roast from microwave oven when desired temperature is reached. Let stand covered with foil 15 minutes.(Temperature may rise about 10°F).
Lamb Lamb roast, rolled boneless (3-4 lbs.)	5	11-12 minutes per pound RARE(135°F) 12-13 minutes per pound MEDIUM(145°F) 13-14 minutes per pound WELL(155°F)	Place roast fat side down on microwavable roast rack. Brush lamb with marinade or desired seasonings such as rosemary, thyme or marjoram. Cover with waxed paper. Turn roast over after 15 minutes, and again after 30 minutes. Shield if necessary. Remove roast from microwave when desired temperature is reached. Let stand covered with foil 15 minutes (Temperature may rise about 10°F).
Pork Bacon slices 2 slices 4 slices 6 slices	HI	1½-2 minutes 2½ -3 minutes 3½-4½ minutes	Place bacon slices on microwavable roast rack. Cover with paper towels. After cooking, let stand 1 minute.
Chops (5-7 oz. each) 2 chops  4 chops	3	18-20 minutes per pound 15-17 minutes per pound	Place chops in microwavable baking dish. Add desired seasonings and cover with vented plastic wrap. Cook until no longer pink or until internal temperature reaches 170°F. Turn chops over halfway through cooking. Let stand covered 5 minutes. (Temperature may rise about 10°F).
Loin Roast, rolled, boneless (3 ½- 4 ½ lbs.)	3	25-27 minutes per pound (165°F)	Place roast in cooking bag in microwavable dish. Add seasonings and browning agent if desired. Close bag loosely with microwavable closure or string. After cooking, let stand in bag 15 minutes. (Temperature may rise about 10°F.) Internal temperature of pork should reach 170°F before serving.
Sausage links, Fresh or Frozen, defrosted (1-2 oz. each) 2 links 4 links 6 links 10 links (8 oz. pkg.)	HI	45-60 seconds 1-1½ minutes 1½-2 minutes 1¾-2 minutes	Pierce links and place on microwavable roast rack. Cover with waxed paper or paper towel. Turn over halfway through cooking. After cooking, let stand covered 1 minute.

# COOKING

## Poultry

### Cooking Poultry: General Directions

- Prepare the poultry for cooking.
  - Defrost completely.
  - Arrange poultry pieces with thicker pieces at the outside edge of the baking dish. When cooking legs, arrange them like the spokes of a wheel.
  - Cover the baking dish with waxed paper to reduce splattering.
  - Use a browning agent or cook with a sauce to give a browned appearance.
- Tend the poultry as it cooks.
  - Drain and discard juices as they accumulate.
  - Shield thin or bony pieces with small strips of aluminum foil to prevent overcooking. Keep foil at **least 1 inch** from the oven walls and other pieces of foil.
- The poultry is done when it is no longer pink and the juices run clear. When done, the temperature in the thigh meat should be 180-185°F.
- Let the poultry stand after cooking covered with foil for 10 minutes.

The Poultry Cooking Table below provides detailed directions, Power Level, and Cooking Time settings for most cuts and types of poultry.

**Poultry Cooking Table**

POULTRY	POWER LEVEL	COOKING TIME	DIRECTIONS
Chicken pieces (2 <sup>1</sup> / <sub>2</sub> -3 lbs).	HI	4 <sup>1</sup> / <sub>2</sub> -5 <sup>1</sup> / <sub>2</sub> minutes per pound	Wash, shake the water off, and go on with cooking. Place pieces in a single layer in a microwavable baking dish with thicker pieces to the outside. Brush with butter or browning agent and seasonings if desired. Cover with waxed paper. Cook until no longer pink and juices run clear. Let stand covered 5 minutes.
Chicken whole (3-3 <sup>1</sup> / <sub>2</sub> lbs)	HI	12-13 minutes per pound	Wash, shake the water off, and go on with cooking. Place breast side down on a microwavable roast rack. Brush with butter, or browning agent and seasoning if desired. Cover with waxed paper. Cook 1/3 of estimated time. Turn breast side up, brush with butter, or browning agent. Replace waxed paper. Cook 1/3 of estimated time again. Shield if necessary. Cook remaining 1/3 of estimated time or until no longer pink and juices run clear. Let stand covered with foil 10 minutes. (The temperature may rise about 10°F.) The temperature in the high should be 180°F-185°F when the poultry is done.
Cornish Hens Whole (1-1 <sup>1</sup> / <sub>2</sub> lbs. each)	HI	6-7 minutes per pound	Wash, shake the water off, and go on with cooking. Tie wings to body of hen and the legs to tail. Place hens breast side down on microwavable rack. Cover with waxed paper. Turn breast side up halfway through cooking. Shield bone ends of drumsticks with foil. Remove and discard drippings. Brush with butter or browning agent and seasonings if desired. Cook until no longer pink and juices run clear. Remove hens from microwave when they reach desired temperature. Let stand covered with foil 5 minutes. (Temperature may rise about 10°F). Temperature in breast should be 170°F before serving.

# COOKING

## Pasta And Rice

Microwave cooking and conventional cooking of pasta, rice, and cereal require about the same amount of time, but the microwave is a more convenient method because you can cook and serve in the same dish.

There is no stirring needed and leftover pasta tastes just like fresh cooked when reheated in the microwave oven.

### Cooking Pasta and Rice: Tips and Techniques

- If you are planning to use rice or pasta in a casserole, undercook it so it is still firm.
- Allow for standing time with rice, but not for pasta.
- The Pasta and Rice Cooking Tables below provide specific directions, with Power Level and Cooking Time settings for most common types of pasta and rice.

### Pasta Cooking Table

TYPE OF PASTA	POWER LEVEL	COOKING TIME	DIRECTIONS
Spaghetti 4 cups water. Add 8 oz. spaghetti.	HI 5	9 to 10 minutes 7 1/2 to 8 1/2 minutes	Combine hot tap water and salt, if desired. Use a 2-quart microwavable baking dish and cover with vented plastic wrap for spaghetti and lasagna noodles. Use microwavable lid or vented plastic wrap for macaroni and egg noodles. Cook at Power Level HI as directed in chart or until water boils. Stir in pasta; cook covered at Power Level 5 as directed in chart or until tender. Drain in a colander.
Macaroni 3 cups water. Add 2 cups macaroni.	HI 5	6 to 7 minutes 5 1/2 to 6 1/2 minutes	
Lasagna noodles 4 cups water. Add 8 oz. lasagna noodles.	HI 5	7 to 8 minutes 11 to 12 1/2 minutes	
Egg noodles 6 cups water. Add 4 cups noodles.	HI 5	8 to 10 minutes 5 1/2 to 6 1/2 minutes	

### Rice Cooking Table

TYPE OF RICE	POWER LEVEL	COOKING TIME	DIRECTIONS
Long grain 2 1/4 cups water. Add 1 cup rice.	HI 5	4 1/2 to 5 1/2 minutes 14 minutes	Combine hot tap water and salt, if desired, in 2 quart microwavable casserole. Cover with microwavable lid or vented plastic wrap. Cook as directed in chart at Power Level HI or until water boils. Stir in rice and any seasonings. Cook covered as directed in chart at Power Level 5 or until water is absorbed and rice is tender. Let stand covered 5 to 10 minutes. Fluff with fork.
Brown 2 1/2 cups water. Add 1 cup rice.	HI 5	4 1/2 to 5 1/2 minutes 28 minutes	
Long grain and wild rice mix 2 1/3 cups water. Add 6 oz. pkg.	HI 5	4 to 5 minutes 24 minutes	
Quick cooking 1 cup water. Add 1 cup rice.	HI	2 to 3 minutes	Cook water until it boils. Stir rice into boiling water and let stand, covered 5 to 10 minutes or until water is absorbed and rice is tender. Fluff with fork.



# MAINTENANCE

## CARE AND CLEANING

For best performance and safety, keep the oven clean inside and outside. Take special care to keep the inner door panel and the oven front frame free of food or grease build-up.

**Never use rough powder or pads.** Wipe the microwave oven inside and out, including the hood bottom cover, with a soft cloth and a warm(not hot) mild detergent solution. Then rinse and wipe dry. Use a chrome cleaner and polish on chrome, metal and aluminum surfaces. Wipe spatters immediately with a wet paper towel, especially after cooking chicken or bacon. Clean your oven weekly or more often, if needed.

## CLEANING THE GREASE FILTERS

The grease filters should be removed and cleaned often, at least once a month.

1. To remove grease filters, slide each filter to the side. Pull filters downward and push to the other side. The filter will drop out.

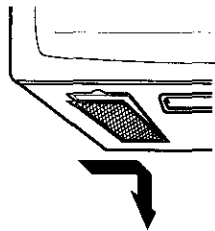

2. Soak grease filters in hot water and a mild detergent. Rinse well and shake to dry. **Do not use ammonia or place in a dishwasher. The aluminum will darken.**

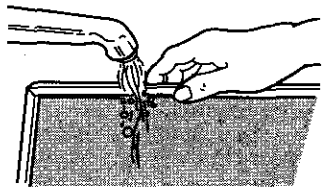

3. To reinstall the filters, slide it into the side slot, then push up and toward oven center to lock.

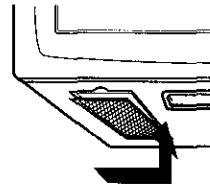

**NOTE: Do not** operate the hood without the filters in place.

## CHARCOAL FILTER REPLACEMENT

If your oven is vented inside, the charcoal filter should be replaced every 6 to 12 months, and more often if necessary. The charcoal filter cannot be cleaned. To order a new charcoal filter, contact the Service Center.

1. Remove the two vent grille mounting screws. (2 middle screws)
2. Tip the grille forward, then lift it out

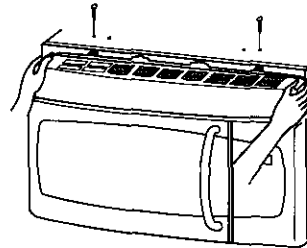

3. Open the door.
4. Push the hook and remove old filter.

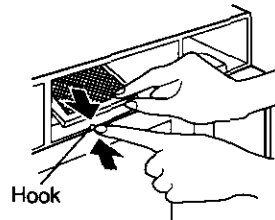

5. Slide a new charcoal filter into place and close the door. The filter should rest at the angle shown and set the clock.

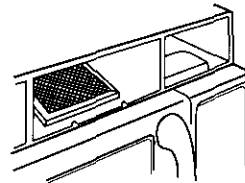

6. Slide the bottom of the vent cover into place. Push the top until it snaps into place. Replace the mounting screws. Turn the power back on at the main power supply and set the clock.

# MAINTENANCE

## COOKTOP/NIGHT LIGHT REPLACEMENT

1. Unplug oven or turn off power at the main power supply.
2. Remove the bulb cover mounting screws.

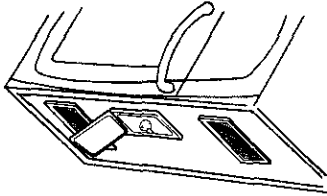

3. Replace bulb with 30 watt appliance bulb.
4. Replace bulb cover, and mount screw.
5. Turn the power back on at the main power supply.

## OVEN LIGHT REPLACEMENT

1. Unplug oven or turn off power at the main power supply.
2. Remove the vent cover mounting screws. (2 middle screws)
3. Tip the cover forward, then lift out to remove.

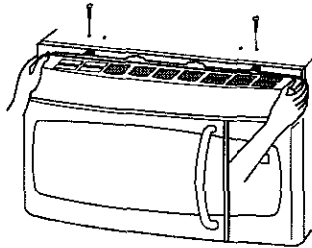

4. Lift up the bulb holder.

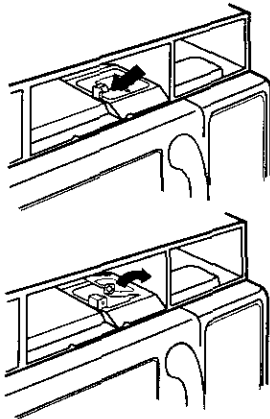

5. Replace bulb with a 30 watt appliance bulb.
6. Replace the bulb holder.
7. Slide the top of the vent cover into place. Push the bottom until it snaps into place. Replace the mounting screws. Turn the power back on at the main power supply.

## QUESTIONS AND ANSWERS

**Q. Can I use a rack in my microwave oven so that I may reheat or cook in two levels at a time?**

**A.** Only use the rack that is supplied with your microwave oven. Use of any other rack can result in poor cooking performance and/or arcing and may damage your oven.

**Q. Can I use either metal or aluminum pans in my microwave oven?**

**A.** Usable metal includes aluminum foil for shielding (use small, flat pieces), and shallow foil trays (if tray is 3/4 inch deep and filled with food to absorb microwave energy). Never allow metal to touch walls or door.

**Q. Sometimes the door of my microwave oven appears wavy. Is this normal?**

**A.** This appearance is normal and does not affect the operation of your oven.

**Q. What are the humming noises that I hear when my microwave oven is operating?**

**A.** You hear the sound of the transformer when the magnetron tube cycles on and off.

**Q. Why does the dish become hot when I microwave food in it? I thought that this should not happen.**

**A.** As the food becomes hot it will conduct the heat to the dish. Use hot pads to remove food after cooking.

**Q. What does "standing time" mean?**

**A.** "Standing time" means that food should be taken out of the oven and covered for additional time after cooking. This process allows the cooking to finish, saves energy and frees the oven for other purpose.

**Q. Can I pop popcorn in my microwave oven? How do I get the best results?**

**A.** Yes. Pop packaged microwave popcorn following manufacturer's guidelines or use the preprogrammed Popcorn pad. Do not use regular paper bags. Use the "listening test" by stopping the oven as soon as the popping slows to a "pop" every one or two seconds. Do not try to repop unpopped kernels. You can also use special microwave poppers. When using a popper, be sure to follow manufacturer's directions. Do not pop popcorn in glass utensils.

**Q. Why does steam come out of the air exhaust vent?**

**A.** Steam is normally produced during cooking. The microwave oven has been designed to vent this steam out the top vent.

# MAINTENANCE

## MICROWAVE UTENSIL GUIDE

USE	DO NOT USE
<p><b>OVENPROOF GLASS</b> (treated for high intensity heat): utility dishes, loaf dishes, pie plates, cake plates, liquid measuring cups, casseroles and bowls without metallic trim.</p> <p><b>CHINA:</b> bowls, cups, serving plates and platters without metallic trim.</p> <p><b>PLASTIC:</b> Plastic wrap (as a cover)-- lay the plastic wrap loosely over the dish and press it to the sides. Vent plastic wrap by turning back one edge slightly to allow excess steam to escape. The dish should be deep enough so that the plastic wrap will not touch the food. As the food heats it may melt the plastic wrap wherever the wrap touches the food. Use plastic dishes, cups, semirigid freezer containers, and plastic bags <b>only for short cooking time. Use these with care because the plastic may soften from the heat of the food.</b></p> <p><b>PAPER:</b> Paper towels, waxed paper, paper napkins, and paper plates with no metallic trim or design. Look for the manufacturer's label for use in the microwave oven.</p>	<p><b>METAL UTENSILS:</b> Metal shields the food from microwave energy and produces uneven cooking. Also avoid metal skewers, thermometers, or foil trays. Metal utensils can cause arcing, which can damage your microwave oven.</p> <p><b>METAL DECORATION:</b> Metal-trimmed or metal-banded dinnerware, casserole dishes, etc. The metal trim interferes with normal cooking and may damage the oven.</p> <p><b>ALUMINUM FOIL:</b> Avoid large sheets of aluminum foil because they hinder cooking and may cause harmful arcing. Use small pieces of foil to shield poultry legs and wings. Keep ALL aluminum foil at least 1 inch from the side walls and door of the oven.</p> <p><b>WOOD:</b> Wooden bowls and boards will dry out and may split or crack when you use them in the microwave oven. Baskets react in the same way.</p> <p><b>TIGHTLY COVERED UTENSILS:</b> Be sure to leave openings for steam to escape from covered utensils. Pierce plastic pouches of vegetables or other food items before cooking. Tightly closed pouches could explode.</p> <p><b>BROWN PAPER:</b> Avoid using brown paper bags. They absorb too much heat and could burn.</p> <p><b>FLAWED OR CHIPPED UTENSILS:</b> Any utensil that is cracked, flawed, or chipped may break in the oven.</p> <p><b>METAL TWIST TIES:</b> Remove metal twist ties from plastic or paper bags. They become hot and could cause a fire.</p>

# MAINTENANCE

## BEFORE CALLING FOR SERVICE

Check the following list to be sure a service call is really necessary. A quick reference of this manual as well as reviewing additional information on items to check may prevent an unneeded service call.

### **If nothing on the oven operates:**

- check for a blown circuit fuse or a tripped main circuit breaker.
- check if oven is properly connected to electric circuit in house.
- check that controls are set properly.

### **If the oven interior light does not work:**

- the light bulb is loose or defective.

### **If oven will not cook:**

- check that control panel was programmed correctly.
- check that door is firmly closed.
- check that Start Pad was pressed.
- check that probe was inserted correctly into receptacle.
- check that timer wasn't started instead of a cook function.

### **If oven takes longer than normal to cook or cooks too rapidly:**

- be sure the Power Level is programmed properly.

### **If the time of day clock does not always keep correct time:**

- check that the power cord is fully inserted into the outlet receptacle.
- be sure the oven is the only appliance on the electrical circuit.

### **If food cooks unevenly:**

- be sure food is evenly shaped.
- be sure food is completely defrosted before cooking.
- check placement of aluminum foil strips used to prevent overcooking.

### **If food is undercooked:**

- check recipe to be sure all directions (amount, time, & power levels) were correctly followed.
- be sure microwave oven is on a separate circuit.
- be sure food is completely defrosted before cooking.

### **If food is overcooked:**

- check recipe to be sure all directions (amount, power level, time, size of dish) were followed.

### **If arcing (sparks) occur:**

- be sure microwavable dishes were used.
- be sure wire twist ties weren't used.
- be sure oven wasn't operated when empty.
- make sure metal rack (if used) is properly installed on 4 supports.

### **If the Display shows a time counting down but the oven is not cooking:**

- check that door is firmly closed.
- check that timer wasn't started instead of a cooking function.

# LG OVER-THE-RANGE MICROWAVE OVEN LIMITED WARRANTY – USA

LG Electronics Inc. will repair or replace your product, at LG's option, if it proves to be defective in material or workmanship under normal use, during the warranty period set forth below, effective from the date of original consumer purchase of the product. This limited warranty is good only to the original purchaser of the product and effective only when used in the United States, including U.S. Territories.

<p><b><u>WARRANTY PERIOD:</u></b></p> <p><b>Model:</b> LMV1630WW/BB/ST</p> <p><b>Labor:</b> 1 Year from the Date of Purchase.</p> <p><b>Parts:</b> 1 Year from the Date of Purchase.</p> <p><b>Magnetron:</b> 8 Years from the Date of Purchase.</p>	<p><b><u>HOW SERVICE IS HANDLED:</u></b></p> <p>Call 1-800-243-0000 and choose the appropriate prompt. Please have product type (Microwave) and ZIP code ready.</p>
--	---

**THIS WARRANTY IS IN LIEU OF ANY OTHER WARRANTIES, EXPRESS OR IMPLIED, INCLUDING WITHOUT LIMITATION, ANY WARRANTY OF MERCHANTABILITY OR FITNESS FOR A PARTICULAR PURPOSE. TO THE EXTENT ANY IMPLIED WARRANTY IS REQUIRED BY LAW, IT IS LIMITED IN DURATION TO THE EXPRESS WARRANTY PERIOD ABOVE. LG WILL NOT BE LIABLE FOR ANY CONSEQUENTIAL, INDIRECT, OR INCIDENTAL DAMAGES OF ANY KIND, INCLUDING LOST REVENUES OR PROFITS, IN CONNECTION WITH THE PRODUCT. SOME STATES DO NOT ALLOW LIMITATION ON HOW LONG AN IMPLIED WARRANTY LASTS OR THE EXCLUSION OF INCIDENTAL OR CONSEQUENTIAL DAMAGES, SO THE ABOVE LIMITATIONS OR EXCLUSIONS MAY NOT APPLY TO YOU.**

**THIS LIMITED WARRANTY DOES NOT APPLY TO:**

1. Service trips to your home to deliver, pick up, and/or install the product, instruct, or replace house fuses or correct wiring, or correction of unauthorized repairs; and
2. Damages or operating problems that result from misuse, abuse, operation outside environmental specifications or contrary to the requirements or precautions in the Operating Guide, accident, vermin, fire, flood, improper installation, acts of God, unauthorized modification or alteration, incorrect electrical current or voltage, or commercial use, or use for other than intended purpose.

**Therefore, the cost of repair or replacement of such a defective product shall be borne by the consumer.**

**CUSTOMER INTER-ACTIVE CENTER NUMBERS:**

<p><b>To Prove Warranty Coverage</b></p>	<p><b>Retain your Sales Receipt to prove date of purchase. A copy of your Sales Receipt must be submitted at the time warranty service is provided.</b></p>
<p><b>To Obtain Nearest Authorized Service Center or Sales Dealer, or to Obtain Product, Customer, or Service Assistance</b></p>	<p><b>Call 1-800-243-0000 (Phone answered 24 hours - 365 days a year) and choose the appropriate prompt from the menu; or visit our website at: <a href="http://us.lgservice.com">http://us.lgservice.com</a>.</b></p>

P/NO. 3828W5A8536

Printed in China

