



Microwave Hood Combination

Use & Care Guide

Horno de Microondas con Combinación de Campana

Manual de uso y cuidado

Models/Modelos 721.81622 / 721.81624
 721.81629 / 721.81623

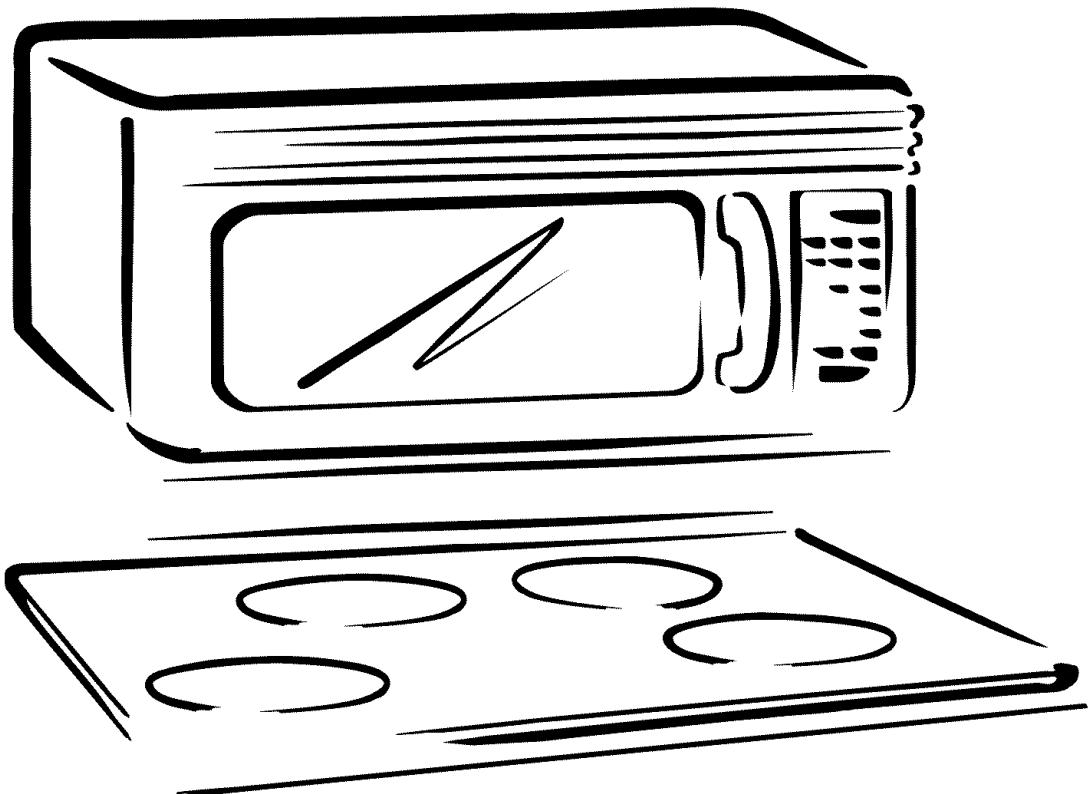

ENGLISH

ESPAÑOL

Table of Contents

Warranty	2
Microwave Oven Safety	3-5
Getting to Know Your Microwave Oven	6-10
How Your Kenmore Microwave Oven Works.....	6
Radio Interference	6
Testing Your Microwave Oven	6
Testing Your Dinnerware or Cookware.....	7
Operating Safety Precautions.....	7
Electrical Connection.....	7
Microwave Oven Features.....	8
Control Panel Features	9-10
Microwave Cooking Tips	11-12
Using Your Microwave Oven	13-20
Audible Signals.....	13
Clock	13
Child Lock	13
Kitchen Timer.....	13
Exhaust Fan	14
Cooktop Light	14
Options.....	14
Timed Cooking	15
Add 30 Sec.	15
Interrupting Cooking.....	15
Multistage Cooking.....	15
Microwave Power Levels	16
Auto Defrost.....	17
Weight Conversion Table	17
Auto Defrost Table.....	18-19
Time Defrost and Express Defrost.....	20
Defrosting Tips	20
Using Sensor Cooking	21-29
Sensor Operating Instructions	21
Sensor Cooking Guide.....	21
Sensor Popcorn.....	21
More/Less	21
Sensor Cook.....	22
Sensor Reheat.....	22
Sensor Cook Table	23
Sensor Reheat Table.....	23
Soften.....	24
Soften Table	24
Melt.....	24
Melt Table.....	24
Grill Cooking Introduction.....	25
Grill Rack.....	25
Crisping Tray.....	25
Auto Grill Cooking	25
Auto Grill Cooking Table.....	26-27
Crisping Tray Cooking Table.....	27
Combi. Cooking.....	28
Combi. Modes Time Table	28
Multimode Cooking.....	28
Caring for Your Microwave Oven	29-32
Caring for the Filters	30-31
Replacing the Cooktop and Oven Lights	31-32
Questions and Answers.....	33
Troubleshooting.....	34-35
Master Protection Agreement.....	71

Microwave Hood Combination Warranty

One-Year Limited Warranty

When installed, operated and maintained according to all instructions supplied with the product, if this appliance fails due to a defect in material or workmanship within one year from the date of purchase, call 1-800-4-MY-HOME® to arrange for free repair.

This warranty covers only defects in material and workmanship. Sears will NOT pay for:

1. Expendable items that can wear out from normal use, including but not limited to filters, belts, light bulbs, and bags.
2. A service technician to instruct the user in correct product installation, operation, or maintenance.
3. A service technician to clean or maintain this product.
4. Damage to or failure of this product if it is not installed, operated, or maintained according to all instructions supplied with the product.
5. Damage to or failure of this product resulting from accident, abuse, misuse, or use for other than its intended purpose.
6. Damage to or failure of this product caused by the use of detergents, cleaners, chemicals, or utensils other than those recommended in all instructions supplied with the product.
7. Damage to or failure of parts or systems resulting from unauthorized modifications made to this product.

Disclaimer of implied warranties, limitation of remedies

Customer's sole and exclusive remedy under this limited warranty shall be product repair as provided herein. Implied warranties, including warranties of merchantability or fitness for a particular purpose, are limited to one year or the shortest period allowed by law. Sears shall not be liable for incidental or consequential damages. Some states and provinces do not allow the exclusion or limitation of incidental or consequential damages, or limitations on the duration of implied warranties of merchantability or fitness, so these exclusions or limitations may not apply to you.

This warranty applies only while this appliance is used in the United States and Canada.

This warranty gives you specific legal rights, and you may also have other rights which vary from state to state.

**Sears, Roebuck and Co., Dept. 817WA,
Hoffman Estates, IL 60179**

**Sears Canada Inc., Toronto, Ontario, Canada
M5B 2B8**

Microwave Oven Safety

Your safety and the safety of others is very important.

We have provided many important safety messages in this manual and on your appliance. Always read and obey all safety messages.



This is the safety alert symbol.

This symbol alerts you to hazards that can kill or hurt you and others.

All safety messages will be preceded by the safety alert symbol and the word “DANGER” or “WARNING.” These words mean:

⚠ DANGER

You will be killed or seriously injured if you don't follow instructions immediately.

⚠ WARNING

You can be killed or seriously injured if you don't follow instructions.

All safety messages will identify the hazard, tell you how to reduce the chance of injury, and tell you what can happen if the instructions are not followed.

IMPORTANT SAFETY INSTRUCTIONS

When using electrical appliances, basic safety precautions should be followed, including the following:

⚠ WARNING: To reduce the risk of burns, electric shock, fire, injury to persons, or exposure to excessive microwave energy:

- Read all instructions before using the microwave oven.
- Read and follow the specific “PRECAUTIONS TO AVOID POSSIBLE EXPOSURE TO EXCESSIVE MICROWAVE ENERGY” found in this section.
- The microwave oven must be grounded. Connect only to properly grounded outlet. See “GROUNDING INSTRUCTIONS” found at the end of this section.
- Install or locate the microwave oven only in accordance with the provided installation instructions.
- Some products such as whole eggs in the shell and sealed containers – for example, closed glass jars – are able to explode and should not be heated in the microwave oven.
- Use the microwave oven only for its intended use as described in this manual. Do not use corrosive chemicals or vapors in the microwave oven. This type of oven is specifically designed to heat, cook, or dry food. It is not designed for industrial or laboratory use.
- As with any appliance, close supervision is necessary when used by children.
- Do not operate the microwave oven if it has a damaged cord or plug, if it is not working properly, or if it has been damaged or dropped.

SAVE THESE INSTRUCTIONS

IMPORTANT SAFETY INSTRUCTIONS

- The microwave oven should be serviced only by qualified service personnel. Call an authorized service company for examination, repair, or adjustment.
- See door surface cleaning instructions in the “Caring for Your Microwave Oven” section.
- To reduce the risk of fire in the oven cavity:
 - Do not overcook food. Carefully attend the microwave oven when paper, plastic, or other combustible materials are placed inside the oven to facilitate cooking.
 - Remove wire twist-ties from paper or plastic bags before placing bags in oven.
 - If materials inside the oven ignite, keep oven door closed, turn oven off, and disconnect the power cord, or shut off power at the fuse or circuit breaker panel.
 - Do not use the cavity for storage purposes. Do not leave paper products, cooking utensils, or food in the cavity when not in use.
- This microwave oven is suitable for use above both gas and electric cooking equipment.
- This microwave oven is intended to be used above ranges with maximum width of 36 inches (91 cm).
- Clean ventilating hoods frequently – grease should not be allowed to accumulate on hood or filter.
- When flaming foods under the hood, turn the fan on.
- Use care when cleaning the vent-hood filter. Corrosive oven cleaners may damage the filter.
- Oversized foods or oversized metal utensils should not be inserted in the microwave oven as they may create a fire or risk of electric shock.
- Do not clean with metal scouring pads. Pieces can burn off the pad and touch electrical parts involving a risk of electric shock.
- Do not store anything directly on top of the microwave oven when the microwave oven is in operation.
- Do not cover or block any openings on the microwave oven.
- Do not store this microwave oven outdoors. Do not use the microwave oven near water – for example, near a kitchen sink, in a wet basement, near a swimming pool, or similar location.
- Do not immerse cord or plug in water.
- Keep cord away from heated surfaces.
- Do not let cord hang over edge of table or counter.
- Do not mount over a sink.
- Do not cover racks or any other part of the oven with metal foil. This will cause overheating of the oven.
- Liquids such as water, coffee, or tea are able to be overheated beyond the boiling point without appearing to be boiling due to surface tension of the liquid. Visible bubbling or boiling when the container is removed from the microwave oven is not always present. This could result in very hot liquids suddenly boiling over when a spoon or other utensil is inserted into the liquid. To reduce the risk of injury to persons:
 - 1) Do not overheat the liquid.
 - 2) Stir the liquid both before and halfway through heating it.
 - 3) Do not use straight-sided containers with narrow necks.
 - 4) After heating, allow the container to stand in the microwave oven for a short time before removing the container.
 - 5) Use extreme care when inserting a spoon or other utensil into the container.

SAVE THESE INSTRUCTIONS

PRECAUTIONS TO AVOID POSSIBLE EXPOSURE TO EXCESSIVE MICROWAVE ENERGY

- (a) Do not attempt to operate this oven with the door open since open-door operation can result in harmful exposure to microwave energy. It is important not to defeat or tamper with the safety interlocks.
- (b) Do not place any object between the oven front face and the door, or allow soil or cleaner residue to accumulate on sealing surfaces.
- (c) Do not operate the oven if it is damaged. It is particularly important that the oven door close properly and that there is no damage to the:
 - (1) Door (bent).
 - (2) Hinges and latches (broken or loosened).
 - (3) Door seals and sealing surfaces.
- (d) The oven should not be adjusted or repaired by anyone except properly qualified service personnel.

Electrical requirements

Observe all governing codes and ordinances. A 120-Volt, 60-Hz, AC-only, 15- or 20-amp fused electrical supply is required. (A time-delay fuse is recommended.) It is recommended that a separate circuit serving only this appliance be provided.

⚠ DANGER



Electrical Shock Hazard
 Plug into a grounded 3 prong outlet. Do not remove ground prong. Do not use an adapter. Do not use an extension cord. Failure to follow these instructions can result in death, fire, or electrical shock.

GROUNDING INSTRUCTIONS

• **For all cord connected appliances:**
 The microwave oven must be grounded. In the event of an electrical short circuit, grounding reduces the risk of electric shock by providing an escape wire for the electric current. The microwave oven is equipped with a cord having a grounding wire with a grounding plug. The plug must be plugged into an outlet that is properly installed and grounded.

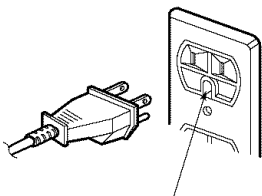

Ensure proper ground exists before use

⚠ WARNING: Improper grounding can result in a risk of electric shock.

Consult a qualified electrician or serviceman if the grounding instructions are not completely understood, or if doubt exists as to whether the microwave oven is properly grounded. Do not use an extension cord. If the power supply cord is too short, have a qualified electrician or serviceman install an outlet near the microwave oven.

• **For a permanently connected appliance:**
 The microwave oven must be connected to a grounded, metallic, permanent wiring system, or an equipment grounding conductor should be run with the circuit conductors and connected to the equipment grounding terminal or lead on the microwave oven.

SAVE THESE INSTRUCTIONS

Getting to Know Your Microwave Oven

This section discusses the concepts behind microwave cooking. It also shows you the basics you need to know to operate your microwave oven. Please read this information before you use your oven.

How Your Kenmore Microwave Hood Combination Works

Microwave energy is not hot. It causes food to make its own heat, and it is this heat that cooks the food. Microwaves are like TV waves, radio waves, or light waves. You cannot see them, but you can see what they do.

A **magnetron** in the microwave oven produces microwaves. The microwaves move into the oven where they contact food as it turns on the turntable.

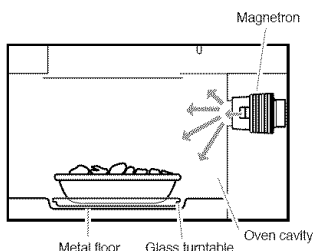

The **glass turntable** of your microwave oven lets microwaves pass through. They then bounce off a metal floor, back through the glass turntable, and are absorbed by the food.

Microwaves pass through most glass, paper, and plastics without heating them so food absorbs the energy. Microwaves bounce off metal containers so food does not absorb the energy.

Sensor Cooking

The Microwave System features Sensor Cooking functions. A humidity sensor in the oven cavity detects moisture and humidity emitted from food as it heats. The sensor adjusts cooking times to various types and amounts of food. Sensor cooking takes the guesswork out of microwave cooking.

For the best cooking results

- **Always cook food** for the shortest cooking time recommended. Check to see how the food is cooking.
- **Stir, turn over, or rearrange** the food being cooked about halfway through the cooking time for all recipes. This will help make sure the food is evenly cooked.
- **If you do not have a cover for a dish**, use wax paper, microwave-approved paper towels, or plastic wrap. Remember to turn back a corner of the plastic wrap to vent steam during cooking.

Radio Interference

Using your microwave oven may cause interference to your radio, TV, or similar equipment. When there is interference, you can reduce it or remove it by:

- **Cleaning** the door and sealing surfaces of the oven.
- **Adjusting** the receiving antenna of the radio or television.

- **Moving** the receiver away from the microwave oven.
- **Plugging** the microwave oven into a different outlet so that the microwave oven and receiver are on different branch circuits.

Testing Your Microwave Oven

To test the oven put about 1 cup (250 ml) of cold water in a glass container in the oven. Close the door and make sure it latches.

Cook at 100% power for 1 minute. When the time is up, the water should be heated.

Testing Your Dinnerware or Cookware

Test dinnerware or cookware before using. To test a dish for safe use, put it into the oven with a cup of water beside it. Cook at 100% cook power for one minute. **If the dish gets hot, do not use it.** Some dishes (melamine, some ceramic dinnerware, etc.) absorb microwave energy, becoming too hot to

handle and slowing cooking times. Cooking in metal containers not designed for microwave use could damage the oven, as could containers with hidden metal (twist-ties, foil lining, staples, metallic glaze or trim).

Operating Safety Precautions

- **Never** lean on the door or allow a child to swing on it when the door is open.
- **Use hot pads.** Microwave energy does not heat containers, but the heat from the food can make the container hot.
- **Do not** use newspaper or other printed paper in the oven.
- **Do not** dry flowers, fruit, herbs, wood, paper, gourds, or clothes in the oven.
- **Do not** start a microwave oven when it is empty. Product life may be shortened. If you practice programming the oven, **place** a container of water in the oven. It is normal for the oven door to look wavy after the oven has been running for a while.
- **Do not** try to melt paraffin wax in the oven. Paraffin wax will not melt in a microwave oven because it allows microwaves to pass through it.
- **Do not** operate the microwave oven unless the glass turntable is securely in place and can move freely. The turntable can move in either direction. **Make sure** the turntable is correct-side up in the oven. **Handle your turntable with care** when removing it from the oven to avoid possibly breaking it. If your turntable cracks or breaks, contact your dealer for a replacement.
- **When you use a browning dish,** the browning dish bottom must be at least 3/16 in. (0.5 cm) above the turntable. Follow the directions supplied with the browning dish.
- **Never cook or reheat a whole egg inside the shell.** Steam buildup in whole eggs may cause them to burst, and possibly damage the oven. **Slice** hard-boiled eggs before heating. In rare cases, poached eggs have been known to explode. **Cover** poached eggs and **allow** a standing time of one minute before cutting into them.
- **For best results, stir any liquid several times during heating or reheating.** Liquids heated in certain containers (especially containers shaped like cylinders) may become overheated. The liquid may splash out with a loud noise during or after heating or when adding ingredients (coffee granules, tea bags, etc.). This can harm the oven.
- **Microwaves** may not reach the center of a roast. The heat spreads to the center from the outer, cooked areas just as in regular oven cooking. This is one of the reasons for letting some foods (for example, roasts or baked potatoes) stand for a while after cooking, or for stirring some foods during the cooking time.
- **Do not deep fry in the oven.** Microwavable utensils are not suitable and it is difficult to maintain appropriate deep-frying temperatures.
- **Do not overcook potatoes.** At the end of the recommended cooking time, potatoes should be slightly firm because they will continue cooking during standing time. **After microwaving, let** potatoes stand for 5 minutes. They will finish cooking while standing.

Electrical Connection

If your electric power line or outlet voltage is less than 110 volts, cooking times may be longer.

Have a qualified electrician check your electrical system.

Microwave Oven Features

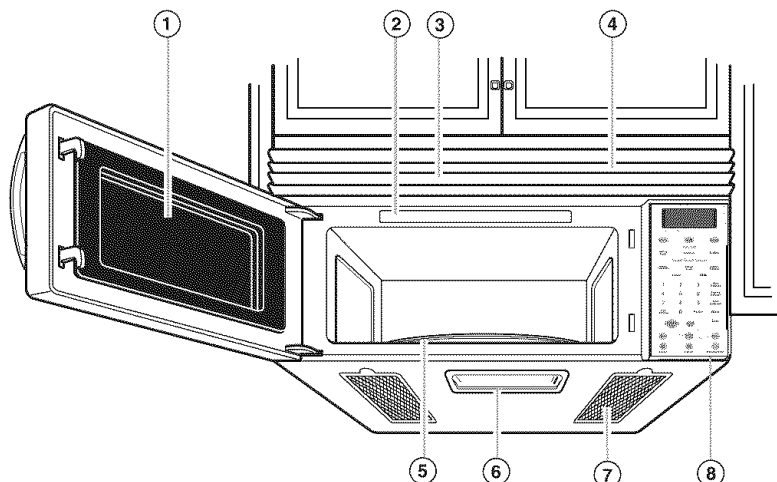

Your microwave oven is designed to make your cooking experience as enjoyable and productive as possible. The following is a list of the oven's basic features:

- 1. Metal Shielded Window.** The shield prevents microwaves from escaping. It is designed as a screen to allow you to view food as it cooks.
- 2. Model and Serial Number Plate & Cooking Guide Label**
- 3. Charcoal Filter** (behind Vent Grille)
- 4. Vent Grille**

5. Turntable. The turntable turns food as it cooks for more even cooking. It must be in the oven during operation for best cooking results.

6. Cooktop Light

7. Grease Filters. See "Caring for the Filters" section.

8. Control Panel. Touch the pads on this panel to perform all functions.

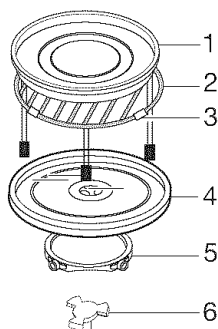

- 1. Crisping Tray
- 2. Grill Rack
- 3. Crisping Tray Support Washer
- 4. Turntable
- 5. Support
- 6. Hub

The turntable rotates in both directions to help food cook more evenly. Do not operate the microwave oven without the turntable in place.

To Install:

- 1.** Place the support on the oven cavity bottom.
- 2.** Place the turntable on the support. Fit the raised, hollowed groove of the turntable bottom between the rollers of the hub. The rollers on the support should fit inside the bottom ridge of the turntable.

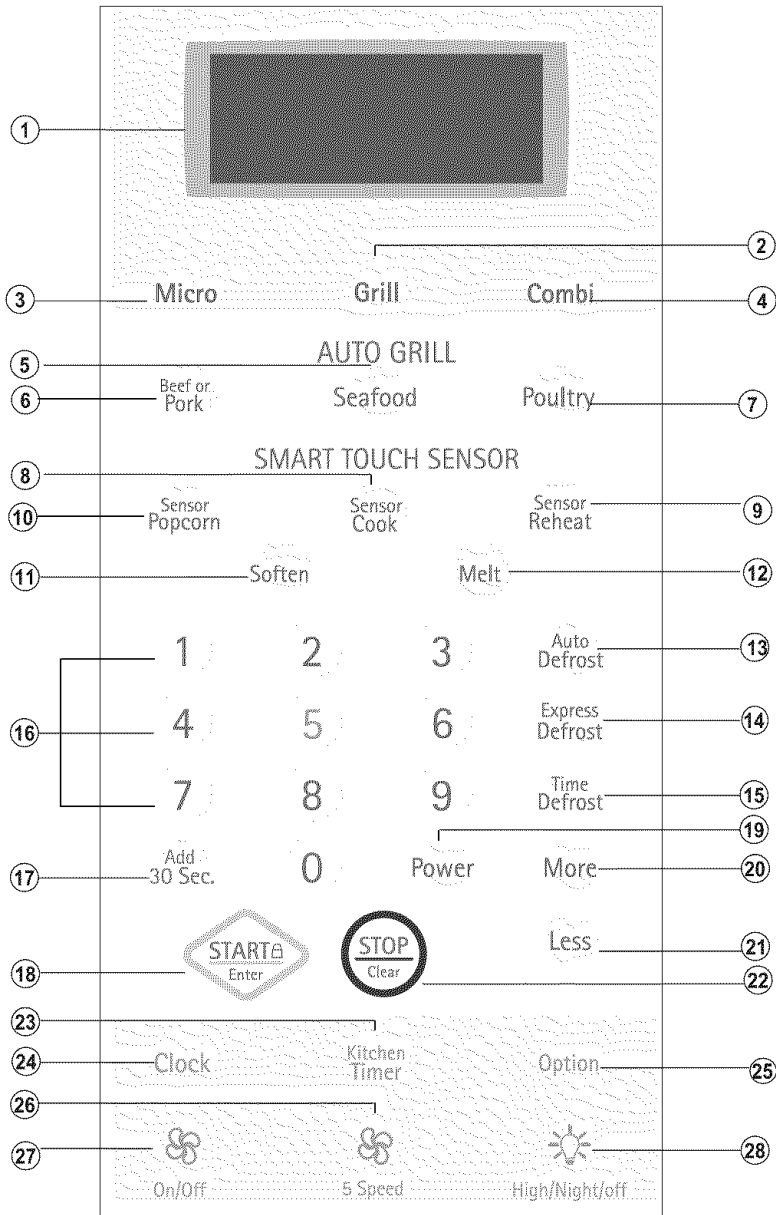

Control Panel Features

Your microwave oven control panel lets you select the desired cooking function quickly and easily by simply touching the appropriate Command Pad. The following is a list of all the Command and Number Pads located on the control panel. **For more information on these features, see “Using Your Microwave Oven” section.**



1. Display. The display includes a clock and indicators to tell you time of day, cooking time settings, cook powers, quantities, weights, and the cooking functions selected.

2. Grill. This feature will allow you to brown and crisp food quickly.

3. **Micro.** This feature will cook food with the microwave function.
4. **Combi.** This feature will cook food with the microwave and the grill functions alternately.
5. **Seafood.** Touch this pad to cook shrimp, fish fillets, or lobster tails easily with the grill function.
6. **Beef or Pork.** Touch this pad to easily cook hamburger patties, beef steaks, and pork chops with the grill function.
7. **Poultry.** Touch this pad to easily cook chicken pieces, chicken breasts, and chicken nuggets with the grill function.
8. **Sensor Cook.** Touch this pad to cook baked potatoes, frozen vegetables, fresh vegetables, canned vegetables, frozen entrees, and rice. The oven sensor will tell the oven how long to cook, depending on the amount of humidity coming from the food.
9. **Sensor Reheat.** Touch this pad to reheat a casserole, dinner plate, pizza slice, or soups/sauces. The oven sensor will tell the oven how long to cook, depending on the amount of humidity coming from the food.
10. **Sensor Popcorn.** Touch this pad to pop popcorn with the sensor feature. The oven sensor will tell the oven how long to cook, depending on the amount of humidity it detects from the popcorn.
11. **Soften.** Touch this pad to soften butter, ice cream, cream cheese, or frozen juice.
12. **Melt.** Touch this pad to melt butter or margarine, chocolate, cheese, or marshmallows.
13. **Auto Defrost.** Touch this pad followed by Number Pads to thaw frozen meat by weight.
14. **Express Defrost.** Touch this pad to defrost 1 lb. (0.5 kg) of frozen ground beef.
15. **Time Defrost.** Touch this pad to choose the amount of time you want to defrost.
16. **Number Pads.** Touch number pads to enter the cooking time, power level, quantities, or weights.
17. **Add 30 sec.** Touch this pad to add 30 seconds of cook time to a cycle or to set and start quickly at 100% power level.
18. **START/Enter.** Touch this pad to start a function or enter all entries. If you open the door after the oven begins to cook, touch START/Enter again.
19. **Power.** To set the amount of microwave energy released to cook the food, touch this pad after the cook time has been set. The higher the number, the higher the microwave power level.
20. **More.** Touching this pad adds 10 seconds of cook time each time you press it.
21. **Less.** Touching this pad subtracts 10 seconds of cook time each time you press it.
22. **STOP/Clear.** Touch this pad to erase an incorrect command, cancel a program during cooking, or to clear the display.
23. **Kitchen Timer.** Touch this pad to set the kitchen timer.
24. **Clock.** Touch this pad to enter the correct time of day.
25. **Option.** Touch this pad to change the oven default setting for sound, clock, display speed, and defrost weights.
26. **Fan () 5 Speed.** Touch this pad to choose one of 5 fan speeds.
27. **Fan () On/Off.** Touch this pad to turn the fan On or Off.
28. **High/Night/Off ().** Touch this pad to turn the light on High, Night, or Off.

NOTE: If you try to enter an incorrect command or setting, you will not hear any beeps. Touch STOP/Clear and re-enter the instructions.

MICROWAVE COOKING TIPS

Amount of Food

- **If you increase or decrease** the amount of food you prepare, the time it takes to cook that food will also change. For example, if you double a recipe, add a little more than half the original cooking time. Check for doneness and, if necessary, add more time in small increments.

Starting Temperature of Food

- **The lower the temperature** of the food being put into the microwave oven, the longer it takes to cook. Food at room temperature will be re-heated more quickly than food at refrigerator temperature.

Composition of Food

- **Food with a lot of fat and sugar** will be heated faster than food containing a lot of water. Fat and sugar will also reach a higher temperature than water in the cooking process.
- **The denser the food**, the longer it takes to heat.

Size and Shape

- **Smaller pieces of food** will cook faster than larger pieces. Also, same-shaped pieces cook more evenly than different-shaped pieces.
- **With foods that have different thicknesses**, the thinner parts will cook faster than the thicker parts. **Place** the thinner parts of chicken wings and legs in the center of the dish.

Stirring and Turning Foods

- **Stirring and turning foods** spreads heat quickly to the center of the dish and avoids overcooking at the outer edges of the food.

Covering Food

Cover food to:

- **Reduce** splattering
- **Shorten** cooking times
- **Keep** food moist

You can use any covering that lets microwaves pass through. See “Getting to Know Your Microwave Oven” for materials that microwaves will pass through. If you are using the Sensor function, be sure to vent.

Releasing Pressure in Foods

- **Several foods** (for example: baked potatoes, sausages, egg yolks, and some fruits) are tightly covered by a skin or membrane. Steam can build up under the membrane during cooking, causing the food to burst. To relieve the pressure and to prevent bursting, **pierce** these foods before cooking with a fork or toothpick.

Using Standing Time

- **Always allow food to stand** either in or outside the oven after cooking power stops. Standing time after defrosting and cooking allows the temperature to evenly spread throughout the food, improving the cooking results. For standing time inside the oven, program a “0” power second stage of the cooking cycle. See “Two-Stage Cooking.”
- **The length of the standing time** depends on the amount of food being cooked and how dense it is. Sometimes it can be as short as the time it takes to remove the food from the oven and move it to the serving table. However, with larger, denser food items, the standing time may be as long as 10 minutes.

Arranging Food

For best results, place food evenly on the plate. You can do this in several ways:

- **If you are cooking several items of the same food**, such as baked potatoes, **place** them in a ring pattern for uniform cooking.
- **When cooking foods of uneven shapes or thickness, such as chicken breasts**, **place** the smaller or thinner area of the food toward the center of the dish where it will be heated last.
- **Layer thin slices of meat** on top of each other.
- **When you cook or reheat whole fish**, **score** the skin – this prevents cracking.
- **Do not** let food or a container touch the top or sides of the oven. This will prevent possible arcing (sparking.)

MICROWAVE COOKING TIPS (CONT.)

Using Aluminum Foil

Metal containers should not be used in a microwave oven. There are, however, some exceptions. If you have purchased food which is prepackaged in an aluminum foil container, refer to the instructions on the package. When using aluminum foil containers, cooking times may be longer because microwaves will only penetrate the exposed top of the food and not the bottom or the sides. If you use aluminum containers without package instructions, follow these guidelines:

- **Place the** aluminum foil container in a glass bowl and add some water so that it covers the bottom of the container, but not more than 1/4 in. (0.64 cm) deep. This ensures even heating of the container bottom.
- **Always remove** the container lid to avoid damage to the oven.
- **Use only** undamaged containers.
- **Do not use** containers taller than 3/4 in. (1.9 cm).
- **Container must be** at least half filled.
- **To avoid arcing**, there must be a minimum 1/4 in. (0.64 cm) between the aluminum container and the walls of the oven and also between two aluminum containers.
- **Always place** the container on the turntable.
- **Shield** parts of food that may cook quickly, such as wing tips and leg ends of poultry, with small pieces of aluminum foil.
- **Heating food** in aluminum foil containers usually takes up to double the time compared to reheating in plastic, glass, china, or paper containers. The time when food is ready will vary depending upon the type of container you use.
- **Let food stand** for 2 to 3 minutes after heating so that heat is spread evenly throughout the container.

Cooking you should not do in your microwave oven

- **Do not** can foods in the oven. Closed glass jars may explode, resulting in damage to the oven.
- **Do not** use the microwave oven to sterilize objects (baby bottles, etc.). It is difficult to keep the oven at the high temperature needed for sterilization.
- **Do not** deep fry foods.

Removing the Grill Rack

- When popping commercially packaged popcorn, **remove the grill rack and crisping tray from the oven**; do not place the bag of microwave popcorn on the rack.

CAUTION:

Popping microwave popcorn with the grill rack and crisping tray can cause fire or damage to the microwave oven.

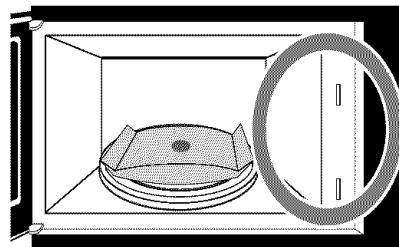
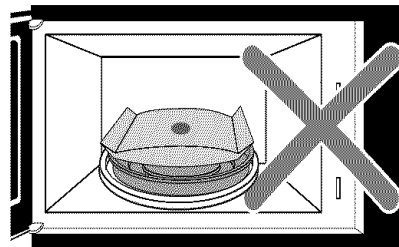
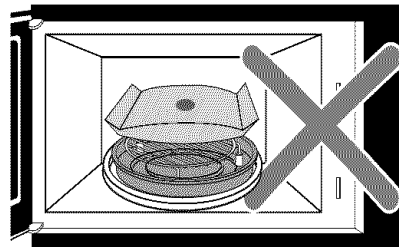

Using Your Microwave Oven

This section gives you instructions for using each function. Please read these instructions carefully.

AUDIBLE SIGNALS

Audible signals are available for guidance when setting and using the oven:









- **A programming tone will beep** each time a key pad is touched.
- **Seven beeps** signal the end of the Kitchen Timer countdown.
- **Four beeps** signal the end of a cooking cycle.

CLOCK

When your microwave oven is first plugged in or after a power failure, the Display will show "PLEASE SET TIME OF DAY." If a time of day is not set, ":" will show on the Display until you touch "Clock."

Example: To set the clock for 10:30 AM.





Touch: **Display Shows:**

1.  :
2.  *ENTER TIME OF DAY*
3.     *10 : 30 TOUCH ENTER*
4.  *10 : 30
AM TOUCH 1
PM TOUCH 2*
5.  *AM 10 : 30
TOUCH ENTER*
6.  *AM 10 : 30*



CHILD LOCK

Use this safety feature to lock the control panel when you are cleaning the oven, or so that children cannot use the oven unsupervised.

To set CHILD LOCK:

- | Touch: | Display Shows: |
|---|---|
| 1.  | Time of day. |
| 2.  
 | Touch and hold until LOCKED appears in the display (approximately 4 seconds). |





To cancel CHILD LOCK:

- | Touch: | Display Shows: |
|--|--|
| 1.  
 | Touch and hold until LOCKED disappears in the display (approximately 4 seconds). |

KITCHEN TIMER

Your microwave oven can be used as a kitchen timer. You can set up to 99 minutes, 99 seconds.

Example: To set for 3 minutes.

- | Touch: | Display Shows: |
|--|---|
| 1.  | <i>ENTER TIME IN MIN
AND SEC</i> |
| 2.    | <i>3 : 00 TOUCH START</i> |
| 3.  | <i>3 : 00 TIMER
TIMER and time
counting down.</i> |

EXHAUST FAN

The two pads on the bottom center of the control panel control the 5-speed exhaust fan.

Example: To set the exhaust fan speed to level 4.

Touch: **Display Shows:**

1.  *LEVEL 1*
On/Off

This shows the last level until the fan speed level is selected.

2.  *LEVEL 4*
5 Speed

Touch until Level 4.

3.  *FAN OFF*
On/Off

Turn off the fan when desired.

NOTE: If the temperature from the range or cooktop below the oven gets too hot, the exhaust fan in the vent hood will automatically turn on at the LEVEL 4 setting to protect the oven. The fan may run up to an hour to cool the oven. When this occurs, the  pad will not turn off the fan. You cannot turn the exhaust fan off during microwave cooking.

COOKTOP LIGHT

A pad on the bottom of the control panel controls the cooktop light.

Example: To set the Lamp to High.

Touch: **Display Shows:**

1.  *LIGHT HI*
High/Night/off

Once for High light
Twice for Night light

2.  *LIGHT OFF*
High/Night/off

To turn off, touch the pad one or two times, depending on the light setting.

OPTIONS

You can change the default values for beep sound, clock, display speed, and defrost weight. See the following chart for more information.

No.	Function	No.	Result
1	Beep ON/ OFF control	1	Sound ON
		2	Sound OFF
2	Clock display control	1	Clock ON
		2	Clock OFF
3	Display	1	Slow speed
		2	Normal speed
		3	Fast speed
4	Defrost weight mode selected	1	Lbs.
		2	Kg.

Example: To change defrost weight mode (from lbs. to kg).

Touch: **Display Shows:**

1.  *SOUND ON / OFF TOUCH 1
CLOCK ON / OFF TOUCH 2
SCROLL SPEED TOUCH 3
LBS / KG TOUCH 4*

2.  *LBS TOUCH 1
KG TOUCH 2*





3.  *KG*

TIMED COOKING

This feature programs a specific cook time and power. There are 10 power level settings in addition to HIGH (100%) power. Refer to the Microwave Power Levels Table for more information.

NOTE: If you do not select a power level, the oven will automatically cook at HIGH (100%) power.



Example: To cook for 5 minutes, 30 seconds at 80% power.

- | Touch: | Display Shows: |
|--|--|
| 1.  | ENTER COOKING TIME |
| 2.  | 5 : 30 TOUCH START
OR POWER LEVEL |
| 3.  | 5 : 30 POWER 100
ENTER POWER LEVEL
0 TO 10 |
| 4.  | 5 : 30 POWER 80
TOUCH START |
| 5.  | Time counting down
and POWER 80 |

ADD 30 SEC.

This simplified control quickly sets and starts microwave cooking at 100% power for 30 seconds without the need to touch START/Enter.

Example: To cook for 1 minute.

- | Touch: | Display Shows: |
|--|-------------------------------------|
| 1.  | Time of day |
| 2.  Twice | Time counting down
and POWER 100 |

NOTE: Each time you touch Add 30 Sec., it will add 30 seconds, up to 99 minutes, 59 seconds.

INTERRUPTING COOKING

Open the door to stop a cooking cycle. The oven and the fan will stop, but the light will stay on.



To restart cooking, close the door and Touch **START/Enter**.



To discontinue cooking, touch **STOP/Clear**.



MULTISTAGE COOKING

Some recipes call for different power levels during the cook cycle. The oven can be programmed to switch from one power level to another.

Example: To set multistage cook cycle.

- | Touch: | Display Shows: |
|--|--|
| 1.  | ENTER COOKING TIME |
| 2.  | 3 : 00 TOUCH START
OR POWER LEVEL

To set a 3 minute
microwave cook time
for first stage. |
| 3.  | 3 : 00 POWER 100
ENTER POWER LEVEL
0 TO 10 |
| 4.  | 3 : 00 POWER 80
TOUCH START

To set an 80% cook
power for the first
stage. |
| 5.  | ENTER COOKING TIME |
| 6.  | 7 : 00 TOUCH START

To set a 7 minute
cook time for second
stage. |
| 7.  | Time counting down and
POWER 80. |

When the first stage is over, two short beeps will sound as the oven begins the second cook stage.

MICROWAVE POWER LEVELS

Your microwave oven offers 10 cook power levels to cook or heat a wide variety of foods. Refer to the table below for suggestions.

Follow recipe or food package instructions if available.

NOTE: Refer to a reliable cookbook for cooking times based on the 1000-Watt cook power of your microwave oven.

COOK Power	LEVEL	WHEN TO USE IT
100% of full power	High	<ul style="list-style-type: none"> • Quickly heating convenience foods and foods with high water content, such as soups and beverages. • Cooking tender cuts of meat, ground meat, or chicken.
9 = 90% of full power		<ul style="list-style-type: none"> • Heating cream soups.
8 = 80% of full power		<ul style="list-style-type: none"> • Heating rice, pasta, or casseroles.
7 = 70% of full power	Medium-High	<ul style="list-style-type: none"> • Cooking and heating foods that need a Cook Power lower than high (for example, whole fish and meat loaf) or when food is cooking too fast. • Reheating a single serving of food.
6 = 60% of full power		<ul style="list-style-type: none"> • Cooking that requires special care, such as cheese and egg dishes, pudding, and custards. • Finishing cooking casseroles.
5 = 50% of full power	Medium	<ul style="list-style-type: none"> • Cooking ham, whole poultry, and pot roasts. • Simmering stews.
4 = 40% of full power		<ul style="list-style-type: none"> • Melting chocolate. • Heating pastries.
3 = 30% of full power	Medium-Low, Defrost	<ul style="list-style-type: none"> • Manually defrosting foods, such as bread, fish, meats, poultry, and precooked foods.
2 = 20% of full power		<ul style="list-style-type: none"> • Softening butter, cheese, and ice cream.
1 = 10% of full power	Low	<ul style="list-style-type: none"> • Keeping food warm. • Taking chill out of fruit.
0 = 0% of full power	No power	<ul style="list-style-type: none"> • Power level "0" allows the temperature to evenly spread through the food, improving the cooking results.





NOTE: Once cook time has been entered, you can also use the Cook Power pad as a second Kitchen Timer by entering "0" for the Cook Power. The oven will count down the cooking time you set without cooking.

AUTO DEFROST

Four defrost sequences are preset in the oven. The auto defrost feature provides the best defrosting method for frozen foods. The cooking guide will show you which defrost sequence is recommended for the food you are defrosting. For added convenience, the Auto Defrost includes a built-in beep mechanism that reminds you to check, turn over, separate, or rearrange the food to get the best defrost results.

- 1 MEAT
- 2 POULTRY
- 3 FISH
- 4 BREAD

Example: To defrost 1.2 lbs. (0.54 kg) of ground beef.

Touch:	Display Shows:
1. 	<i>MEAT TOUCH 1</i> <i>POULTRY TOUCH 2</i> <i>FISH TOUCH 3</i> <i>BREAD TOUCH 4</i>
2. 	<i>MEAT</i> <i>ENTER WEIGHT</i>
3.  and  to enter the weight	<i>1.2 Lbs</i> <i>TOUCH START</i>
4. 	Time counting down and DEFROST

NOTE:

When you touch the START pad, the display changes to defrost time count down. The oven will beep during the DEFROST cycle. At this time, open the door and turn, separate, or rearrange the food. Remove any portions that have thawed. Return frozen portions to the oven and touch START to resume the defrost cycle.

This table shows you food type selections and the weights you can set for each type. For best results, loosen or remove the covering on food.

FOOD	TOUCH Auto Defrost	WEIGHTS YOU CAN SET (tenths of a pound)
Meat	1	0.1 to 6.0 (45g to 2.7 kg)
Poultry	2	0.1 to 6.0 (45g to 2.7 kg)
Fish	3	0.1 to 6.0 (45g to 2.7 kg)
Bread	4	0.1 to 1.0 (45g to 450g)

WEIGHT CONVERSION TABLE

You are probably used to food weights expressed in pounds and ounces that are fractions of a pound (for example, 4 oz. [115 g] equals 1/4 lb. [0.11kg]). However, in order to enter food weight in Auto Defrost, you must specify pounds and tenths of a pound.

If the weight on the food package is in fractions of a pound, you can use the following table to convert the weight to decimals.

Equivalent Weight		
OUNCES	DECIMAL WEIGHT	
1.6	0.10	
3.2	0.20	
4.0	0.25	1/4 lb.
4.8	0.30	
6.4	0.40	
8.0	0.50	1/2 lb.
9.6	0.60	
11.2	0.70	
12.0	0.75	3/4 lb.
12.8	0.80	
14.4	0.90	
16.0	1.00	1 lb.

NOTE:

For 1/4-lb. or 3/4-lb. (115-g or 350-g) food weights, round up or down to a whole Decimal Weight. For example, select either 2.0 or 3.0 for 1/4 lb. (115 g) of food.

AUTO DEFROST TABLE

Meat setting

FOOD	SETTING	AT BEEP	SPECIAL INSTRUCTIONS
BEEF			
Ground Beef, Bulk	MEAT	Remove thawed portions with a fork. Turn over. Return remainder to oven.	Do not defrost less than 1/4 lb. (115 g). Freeze in doughnut shape.
Ground Beef, Patties	MEAT	Separate and rearrange.	Do not defrost less than 2-oz. (50-g) patties. Depress center when freezing.
Round Steak	MEAT	Turn over. Cover warm areas with aluminum foil.	Place on a microwavable roasting rack.
Tenderloin Steak	MEAT	Turn over. Cover warm areas with aluminum foil.	Place on a microwavable roasting rack.
Stew Beef	MEAT	Remove thawed portions with a fork. Separate remainder. Return remainder to oven.	Place in a microwavable baking dish.
Pot Roast, Chuck Roast	MEAT	Turn over. Cover warm areas with aluminum foil.	Place on a microwavable roasting rack.
Rib Roast	MEAT	Turn over. Cover warm areas with aluminum foil.	Place on a microwavable roasting rack.
Rolled Rump Roast	MEAT	Turn over. Cover warm areas with aluminum foil.	Place on a microwavable roasting rack.
LAMB			
Cubes for Stew	MEAT	Remove thawed portions with a fork. Return remainder to oven.	Place in a microwavable casserole dish.
Chops (1 in. [2.5 cm] thick)	MEAT	Separate and rearrange.	Place on a microwavable roasting rack.
PORK			
Chops (1/2 in. [2.5 cm] thick)	MEAT	Separate and rearrange.	Place on a microwavable roasting rack.
Hot Dogs	MEAT	Separate and rearrange.	Place on a microwavable roasting rack.
Spareribs or Country-style Ribs	MEAT	Turn over. Cover warm areas with aluminum foil.	Place on a microwavable roasting rack.
Sausage, Links/Patties	MEAT	Separate and rearrange.	Place on a microwavable roasting rack.
Sausage, Bulk	MEAT	Remove thawed portions with a fork. Turn over. Return remainder to oven.	Place in a microwavable baking dish.
Loin Roast, Boneless	MEAT	Turn over. Cover warm areas with aluminum foil.	Place on a microwavable roasting rack.

NOTE:

Meat of irregular shape and large, fatty cuts of meat should have the narrow or fatty areas shielded with foil at the beginning of a defrost sequence.

AUTO DEFROST TABLE (CONT.)

Poultry setting

FOOD	SETTING	AT BEEP	SPECIAL INSTRUCTIONS
CHICKEN Whole	POULTRY	Turn over (finish defrosting breast-side down). Cover warm areas with aluminum foil.	Place chicken breast-side up on a microwavable roast rack. Finish defrosting by immersing in cold water. Remove giblets when chicken is partially defrosted.
		Pieces	Separate pieces and rearrange. Turn over. Cover warm areas with aluminum foil.
CORNISH HENS Whole	POULTRY	Turn over. Cover warm areas with aluminum foil.	Place on a microwavable roasting rack. Finish defrosting by immersing in cold water
TURKEY Breast (up to 6 lbs. [2.7 kg])	POULTRY	Turn over. Cover warm areas with aluminum foil.	Place on a microwavable roasting rack. Finish defrosting by immersing in cold water

Fish setting

FOOD	SETTING	AT BEEP	SPECIAL INSTRUCTIONS
FISH Fillets	FISH	Turn over. Separate fillets when partially thawed, if possible.	Place in a microwavable baking dish. Carefully separate fillets under cold water.
Steaks	FISH	Separate and rearrange.	Place in a microwavable baking dish. Run under cold water to finish defrosting.
Whole	FISH	Turn over.	Place in a microwavable baking dish. Finish defrosting by immersing in cold water.
SHELLFISH			
Crabmeat	FISH	Break apart. Turn over.	Place in a microwavable baking dish.
Lobster tails	FISH	Turn over and rearrange.	Place in a microwavable baking dish.
Shrimp	FISH	Separate and rearrange.	Place in a microwavable baking dish.
Scallops	FISH	Separate and rearrange.	Place in a microwavable baking dish.



Bread setting

FOOD	SETTING	AT BEEP	SPECIAL INSTRUCTIONS
Bagel Dinner Roll Hamburger Hot Dog Bun Slices of Bread Loaf of Bread	BREAD	Turn over and rearrange.	Place on 3 sheets of paper towel.

TIME DEFROST

This feature allows you to choose the time you want to defrost.



Example: To defrost for 3 minutes.

- | Touch: | Display Shows: |
|--|--|
| 1.  | : ENTER DEFROST
TIME |
| 2.  | 3: 00 TOUCH START |
| 3.  | Time counting down and
TIME DEFROST
scrolls across display |

EXPRESS DEFROST

This feature defrosts ground meat for browning.

Example: To defrost 1 lb. (0.5 kg) of ground meat.

- | Touch: | Display Shows: |
|--|--|
| 1.  | 1.0 Lbs
TOUCH START |
| 2.  | Time counting down and
EXPRESS DEFROST
scrolls across display. |

DEFROSTING TIPS

- **When using** Auto Defrost, the weight to be entered is the net weight in pounds and tenths of pounds (the weight of the food minus the container).
- **Before starting**, make sure you have removed any of the metal twist-ties which often come with frozen food bags, and replace them with strings or elastic bands.
- **Open containers** such as cartons before they are placed in the oven.
- **Always slit** or pierce plastic pouches or packaging.
- **If food is foil wrapped**, remove foil and place it in a suitable container.
- **Slit** the skins, if any, of frozen food such as sausage.
- **Bend** plastic pouches of food to ensure even defrosting.
- **Always underestimate** defrosting time. If defrosted food is still icy in the center, return it to the microwave oven for more defrosting.
- **The length** of defrosting time varies according to how solidly the food is frozen.
- **The shape of the package** affects how quickly food will defrost. Shallow packages will defrost more quickly than deep packages.
- **As food begins to defrost**, separate the pieces. Separated pieces defrost more easily.
- **For best results**, remove fish, shellfish, meat, and poultry from its original closed paper or plastic package (wrapper). Otherwise, the wrap will hold steam and juice close to the foods, which can cause the outer surface of the foods to cook.
- **For best results**, shape your ground meat into the form of a doughnut before freezing. When defrosting, scrape off thawed meat when the beep sounds and continue defrosting.
- **Place foods** in a shallow container or on a microwave roasting rack to catch drippings.
- **For better results**, let food stand after defrosting. (For more information on standing time, see the "Microwave Cooking Tips" section.)
- **Turn over** food during defrosting or standing time. Break apart and remove food as required.

Using Sensor Cooking

SENSOR COOKING

SENSOR OPERATING INSTRUCTIONS

Sensor Cook allows you to cook most of your favorite foods without selecting cooking times and power levels. The oven automatically determines required cooking time for each food item. When the internal sensor detects a certain amount of humidity coming from the food, it will tell the oven how much longer to heat. The display will show the remaining heating time. For best results in cooking with the Sensor, follow these recommendations:

- Food cooked with the sensor system should be at normal storage temperature.
- Glass Tray and outside of the container should be dry to assure best cooking results.
- Foods should always be loosely covered with microwavable plastic wrap, waxed paper, or a lid.
- Do not open the door or touch the STOP/Clear pad during the sensing time. When the sensing time is over, the oven beeps twice and the remaining cooking time will appear in the display window. At this time, you can open the door to stir, turn, or rearrange the food.

SENSOR COOKING GUIDE

Appropriate containers and coverings help assure good Sensor cooking results.

- Always use microwavable containers and cover them with lids or vented plastic wrap.
- Never use tight-sealing plastic covers. They can prevent steam from escaping and cause food to overcook.
- Match the amount to the size of the container. Fill containers at least half full for best results.
- Be sure the outside of the cooking container and the inside of the microwave oven are dry before placing food in the oven. Beads of moisture turning into steam can mislead the sensor.

SENSOR POPCORN

Sensor cook allows you to cook most of your favorite foods without selecting cooking times and power levels.

Example : To pop popcorn.

Touch: **Display Shows:**

- | | | |
|----|---|---|
| 1. |  | Time of day. |
| 2. |  | <i>POPCORN</i>
scrolls across display. |

When the cook time is over, you will hear four beeps and **COOK END** will display.





MORE/LESS

By using the More or Less pads, all of the sensor cook and time cook settings can be adjusted to cook food for a longer or shorter time.

Pressing More will add 10 seconds of cooking time each time you press it.

Pressing Less will subtract 10 seconds of cooking time each time you press it.

Example: To adjust the cooking time.

- | | |
|---------------|--|
| Touch: | Display Shows: |
| 1. |  Time of day. |
| 2. |  <i>1:00</i>
<i>TOUCH START OR</i>
<i>POWER LEVEL</i> |
| 3. |  <i>1:00</i>
<i>POWER 100</i> |
| 4. |  Remaining time will be increased by 10 seconds. |

NOTE:

 Remaining time will be decreased by 10 seconds.

SENSOR COOK

Using SENSOR COOK lets you heat common microwave-prepared foods without needing to program times and Cook Powers. SENSOR COOK has preset Cook Power for 6 food categories.

Example: To cook rice.

Touch: **Display Shows:**

1.  *SELECT MENU 1 TO 6*

2.  *RICE*
scrolls across display.

Choose food category:

CATEGORY	TOUCH PAD TIME	AMOUNT
Baked Potato	1	1–4 ea.
Frozen Vegetable	2	1–4 cups (250–1000 ml)
Fresh Vegetable	3	1–4 cups (250–1000 ml)
Canned Vegetable	4	1–4 cups (250–1000 ml)
Frozen Entree	5	10.5–21 oz. (275–575 ml)
Rice	6	0.5–2 cups (125 ml–500 ml)

The oven will cook food automatically by the sensor system. When the cook time is over, four beeps will sound and **COOK END** will be displayed.

SENSOR REHEAT

Using SENSOR REHEAT lets you heat common microwave-prepared foods without needing to program times and Power levels.

Example: To reheat 2 slices of pizza.

Touch: **Display Shows:**

1.  *SELECT MENU 1 TO 4*

2.  *PIZZA SLICE*
scrolls across display.

Choose food category:

CATEGORY	TOUCH PAD TIME	AMOUNT
Dinner Plate	1	10.3–15.5 oz. (280–425 ml)
Soup/Sauce	2	1–4 cups (250–1000 ml)
Casserole	3	1–4 cups (250–1000 ml)
Pizza Slice	4	1–3 slices

The oven will cook food automatically by sensor system. When the cook time is over, four beeps will sound and **COOK END** will be displayed.

SENSOR COOK TABLE

CATEGORY		DIRECTION	AMOUNT
Baked Potato		Pierce each potato with a fork and place on the oven tray around the edge, at least one inch apart.	1–4 ea, 8–10 oz. (225–285 g)
VEGETABLES	Frozen Vegetable	Remove frozen vegetables from the package and place in an appropriately-sized microwave container. Cover with plastic wrap and vent. Follow package instructions.	1–4 cups (250–1000 ml)
	Fresh Vegetable	Prepare fresh vegetables as desired, wash, and place in an appropriately-sized microwave container. Cover with plastic wrap, and vent.	1–4 cups (250–1000 ml)
	Canned Vegetable	Remove vegetables from the can. Place in an appropriately sized microwave container, cover with plastic wrap, and vent. After cooking, stir and allow to stand for 3 minutes.	1–4 cups (250–1000 ml)
Frozen Entree		Remove from the package. Slit the cover. If not in microwave-safe container, place on a plate, cover with plastic wrap, and vent.	10–21 oz. (275–575 ml)
Rice		Add twice the amount of water to the rice. Use a microwave container large enough to prevent water from boiling over the dish. Cover with plastic wrap or lid.	0.5–2 cups (125 ml–500 ml)

ENGLISH





SENSOR REHEAT TABLE

CATEGORY		DIRECTION	AMOUNT
Dinner Plate		Place on a low plate. Cover with vented plastic wrap. Let stand 3 minutes.	10.3–15.5 oz. (280–425 ml)
Soup/Sauce		Place in shallow microwavable casserole dish. Cover with vented plastic wrap. After cooking, stir and let stand 3 minutes.	1–4 cups (250–1000 ml)
Casserole		Cover the dish with plastic wrap and vent. After cooking, stir and allow to stand for 3 minutes.	1–4 cups (250–1000 ml)
Pizza Slice		This is a reheat function for leftover pizza. Place on a paper towel or on a microwave-safe plate.	1–3 slices, 3–5 oz. (85–140 g) each

SOFTEN

The oven uses low power to soften foods (butter, ice cream, cream cheese, and frozen juice). See the following table.

Example: To soften a pint of ice cream.





- | | |
|--|-----------------------------------|
| Touch: | Display Shows: |
| 1.  | <i>SELECT MENU 1 TO 4</i> |
| 2.  | <i>ICE CREAM
TOUCH 1 TO 3</i> |
| 3.  | <i>PINT TOUCH START</i> |
| 4.  | <i>ICE CREAM</i> |

Four beeps signal when the cook time is over, and **COOK END** will display.

MELT

The oven uses low power to melt foods (butter or margarine, chocolate, marshmallows, or processed cheese food). See the following table.

Example: To melt 8 oz. (225 g) of chocolate.

- | | |
|--|---|
| Touch: | Display Shows: |
| 1.  | <i>SELECT MENU 1 TO 4</i> |
| 2.  | <i>CHOCOLATE
TOUCH 1 TO 2</i> |
| 3.  | <i>8 oz
TOUCH START</i> |
| 4.  | Time counting down.
<i>CHOCOLATE</i> |

Four beeps signal when the cook time is over, and **COOK END** will display.

SOFTEN TABLE

CODE	CATEGORY	DIRECTION	AMOUNT
1	Butter	Unwrap and place in microwavable container. Butter will be at room temperature and ready for use in recipe.	1, 2, or 3 sticks
2	Ice Cream	Place container in oven. Ice cream will be soft enough to make scooping easier.	Pint, Quart, Half-Gallon
3	Cream Cheese	Unwrap and place in microwavable container. Cream cheese will be at room temperature and ready for use in recipe.	3 or 8 oz. (85 or 225 g)
4	Frozen Juice	Remove top. Place in oven. Frozen juice will be soft enough to easily mix with water.	6, 12, or 16 oz. (170, 350, or 450 g)

MELT TABLE

CODE	CATEGORY	DIRECTION	AMOUNT
1	Butter or Margarine	Unwrap and place in a microwavable container. No need to cover butter. Stir at the end of cooking to complete melting.	1, 2, or 3 sticks
2	Chocolate	Chocolate chips or squares of baking chocolate may be used. Unwrap squares and place in a microwavable container. Stir at the end of cycle to complete melting.	4 or 8 oz. (115 or 225 g)
3	Cheese	Use processed cheese food only. Cut into cubes. Place in a single layer in a microwavable container. Stir at the end of cooking to complete melting.	8 or 16 oz. (225 or 450 g)
4	Marshmallows	Large or miniature marshmallows may be used. Place in a microwavable container. Stir at the end of cycle to complete melting.	5 or 10 oz. (140 or 285 g)

GRILL COOKING INTRODUCTION

This oven cooks the outside of foods much like conventional radiant heat, while also penetrating the surface so the inside cooks simultaneously. Grilling is cooking under direct heat. This oven can grill meat, fish, poultry, and vegetables, or toast bread.

Your oven uses grill cooking whenever you use the Grill Command Pads.

- Foods that are suitable for broiling should be tender, moderately lean and no more than 1 in. (2.5 cm) thick. Fish steaks, chicken breasts, and hamburgers are ideal for grilling.
- For even browning, turn the food over after 2/3 of grilling time.
- Do not leave the door open for a long period of time when using the grill element. This will cause the oven temperature to drop and could affect cooking performance.
- For best grilling performance, limit use of fan speeds to 1, 2, or 3 while grilling.

GRILL RACK

When cooking very oily food, place the food directly on the grill rack and put a heatproof dish on the glass turntable to catch the drippings.

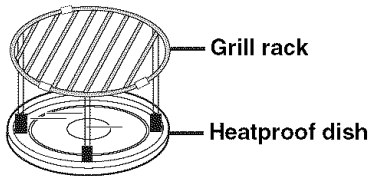

IMPORTANT: Do not use the crisping tray as a drip pan.

IMPORTANT: Do not remove white support washers from grilling rack. These are designed for safety purposes.

CAUTION:

-To avoid risk of personal injury or property damage, do not touch heater elements and barrier after cooking.

-If the heater elements broken, disconnect the power cord from the electrical outlet to avoid risk of personal injury or property damage. Call for service.

CRISPING TRAY

The crisping tray with nonstick surface has been designed for grill and microwave cooking. Refer to the "Crisping Tray Cooking" table for more information.

Do not use this as a drip pan.

When microwave cooking, place the tray on the glass turntable.

When grilling, place the crisping tray on the grill rack.

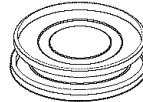

Microwave Cooking

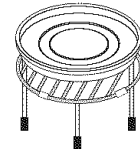

Grilling and Grilling Combi.

AUTO GRILL COOKING

Use this function to cook food without entering a cook time. Refer to the "Auto Grill Cooking" table for more information.

Example: To cook 1 chicken breast.

Touch:	Display Shows:
1. Poultry	SELECT MENU 1 TO 3
2. 2	CHICKEN BREASTS TOUCH 1 TO 4
3. 1	1 PIECE TOUCH START
4. START/Cancel	CHICKEN BREASTS

NOTE: When the oven stops, use oven mitts to carefully remove the dish; it may be very hot.

NOTE: During and after use, do not touch, or let clothing, pot holders, or other materials contact the cooking elements. These surfaces may be hot enough to burn. Allow sufficient time for cooling first.

AUTO GRILL COOKING TABLE

Beef or Pork

FOOD	AMOUNT	REMARKS
Hamburger Patties	1–2 patties, 1/2 in. (1 cm)	Place hamburger patties on the crisping tray and grill rack. When the oven beeps, turn food over.
	3–4 patties, 1/2 in. (1 cm)	
	1–2 patties, 1 in. (2.5 cm)	
	3–4 patties, 1 in. (2.5 cm)	
Beef Steaks	1–2 pieces, 1/2 in. (1 cm), Medium	Brush beef with oil and place on the crisping tray and grill rack. When the oven beeps, turn food over.
	1–2 pieces, 1/2 in. (1 cm), Well-done	
	1–2 pieces, 1 in. (2.5 cm), Medium	
	1–2 pieces, 1 in. (2.5 cm), Well-done	
Pork Chops	1-2 pieces, 1/2 in. (1 cm)	Brush pork with oil and place on the crisping tray and grill rack. When the oven beeps, turn food over.
	3–4 pieces, 1/2 in. (1 cm)	
	1–2 pieces, 1 in. (2.5 cm)	
	3-4 pieces, 1 in. (2.5 cm)	

Seafood

FOOD	AMOUNT	REMARKS
Fish Fillet	1 piece	Place fish fillet on the crisping tray and the grill rack. When the oven beeps, turn food over.
	2 pieces	
	3 pieces	
	4 pieces	
Shrimp	4 oz. (115 g)	Wash and dry. Place the shrimp on the crisping tray and grill rack. When the oven beeps, turn food over.
	8 oz. (225 g)	
	12 oz. (350 g)	
	16 oz. (450 g)	
Lobster Tails	1–2 pieces, 1/2 in. (1 cm)	Wash and dry. Place the lobster tail on the crisping tray and grill rack. When the oven beeps, turn food over.
	3–4 pieces, 1/2 in. (1 cm)	
	1–2 pieces, 1 in. (2.5 cm)	
	3–4 pieces, 1 in. (2.5 cm)	

AUTO GRILL COOKING TABLE (CONT.)

Poultry

FOOD	AMOUNT	REMARKS
Chicken Pieces	1 piece	Wash and dry. Brush chicken with oil and place on the crisping tray and grill rack. When the oven beeps, turn food over. After cooking, let stand covered with foil for 3–5 minutes.
	2 pieces	
	3 pieces	
	4 pieces	
Chicken Breasts	1 piece	Wash and dry. Brush chicken with oil and place on the crisping tray and grill rack. When the oven beeps, turn food over.
	2 pieces	
	3 pieces	
	4 pieces	
Chicken Nuggets	4 pieces	Place frozen chicken nuggets in a single layer on the crisping tray and grill rack. When the oven beeps, turn food over.
	6 pieces	
	8 pieces	
	10 pieces	

CRISPING TRAY COOKING TABLE

Preheat the crisping tray for 3 minutes at microwave power high. After preheating, place food on the crisping tray in a single layer.





CATEGORY	FOOD	AMOUNT	MODE	COOK TIME (MIN)
Reheat Baked Foods	Biscuits, brownies, cookies, muffins, rolls	4–8 each	Microwave High	0.5–1
Reheat Frozen Foods	Chicken nuggets	1–4 servings	Grill Combi.	10–14
	French toast	1–4 pieces	Grill Combi.	3–4
	Hashbrowns	1–4 patties	Grill Combi.	3–5
	Rising crust pizza	6–9 in. (15–23 cm)	Grill Combi.	10–17
	Thin crust pizza	6–9 in. (15–23 cm)	Grill Combi.	5–8
	Cheese sticks	1–4 servings	Grill Combi.	8–12
Meat	Bacon	2–4 slices	Microwave High	2–4
	Steak	1–2 pieces	Grill	20–25
	Ham slice	2–4 slices	Grill	10–13
	Sausage	2–10 links	Grill	8–12
Eggs*	Fried egg	1–4 eggs	Microwave High	2–6
	Omelet	2–4 eggs	Microwave High	6–10

***Caution**

Pierce egg yolks and whites several times with a fork, or the eggs may explode during cooking.

COMBI. COOKING

Your oven has a grill + micro cooking feature which allows you to cook food with the grill function and the microwave alternately. This generally means it takes less time to cook your food. Before cooking, you can select one of three cooking modes. The grill rack and crisping tray can be used during cooking.

- | Touch: | Display Shows: |
|--|---|
| 1.  Combi | <i>Co - 1</i>
: ENTER COOKING TIME
OR TOUCH COMBI |
| 2.  Combi | <i>Co - 2</i>
: ENTER COOKING TIME
OR TOUCH COMBI |
| 3.  | <i>3 : 00 TOUCH START</i> |
| 4.  | Time counting down and
<i>COMBI 2</i>
scrolls across display. |

COMBI. MODES COOKING TABLE

CATEGORY	FOODS
<i>Co - 1</i>	Hot dogs, hamburgers, or chicken
<i>Co - 2</i>	Whole chicken, roast beef, or baked potato

NOTE: When the oven stops, use oven mitts to carefully remove the dish; it may be very hot.

NOTE: During and after use, do not touch, or let clothing, pot holders, or other flammable materials contact the cooking elements. These surfaces may be hot enough to burn. Allow sufficient time for cooling first.







CAUTION:

If smoke is observed, turn off or disconnect the oven from the power supply and keep the oven door closed in order to stifle any flames.

MULTIMODE COOKING

For best results, some recipes call for different heat sources during the cooking cycle. You can program your oven to switch from the microwave cooking level to the grill function.

Example: To set multi-mode cook cycle.

- | Touch: | Display Shows: |
|---|---|
| 1.  Micro | <i>ENTER COOKING TIME</i> |
| 2. 
To set a 3 minute microwave cook time for first stage | <i>3 : 00 TOUCH START</i>
OR <i>POWER LEVEL</i> |
| 3.  Power | <i>3 : 00 POWER 100</i>
<i>ENTER POWER LEVEL</i>
<i>0 TO 10</i> |
| 4. 
To set an 80% cook power for the first stage. | <i>3 : 00 POWER 80</i>
<i>TOUCH START</i> |
| 5.  Grill | <i>ENTER COOKING TIME</i> |
| 6. 
To set a 7 minute grill cook time for second stage. | <i>7 : 00 TOUCH START</i> |
| 7.  | Time counting down and
<i>POWER 80</i> |

When the first stage is over, two short beeps will sound as the oven begins the second cook stage.

Caring for Your Microwave Oven

To make sure your microwave oven looks good and works well for a long time, you should maintain it properly. For proper care, please follow these instructions carefully.

For interior surfaces: Wash often with warm, sudsy water and a sponge or soft cloth. Use only mild, nonabrasive soaps or a mild detergent. Be sure to keep the areas clean where the door and oven frame touch when closed. Wipe well with a clean cloth.

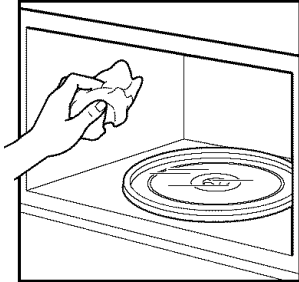

Over time, stains can appear on the surfaces as the result of food particles spattering during cooking. This is normal.

For stubborn soil, boil a cup of water in the oven for 2 to 3 minutes. Steam will soften the soil. To get rid of odors inside the oven, boil a cup of water with some lemon juice or vinegar in it.

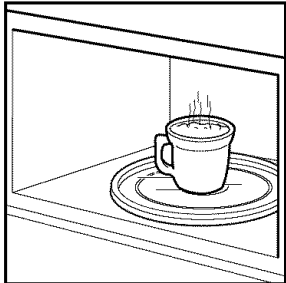

For exterior surfaces and control panel: Use a soft cloth with spray glass cleaner. Apply the spray glass cleaner to the soft cloth; do not spray directly on the oven.

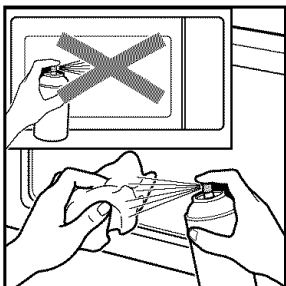

NOTE: Abrasive cleansers, steel wool pads, gritty wash cloths, some paper

towels, etc., can damage the control panel and the interior and exterior oven surfaces.

To clean the turntable and turntable support,

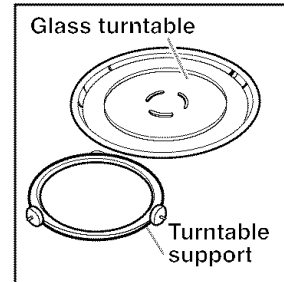

wash in mild, sudsy water; for heavily soiled areas use a mild cleanser and scouring sponge. The turntable and turntable support are dishwasher safe.

To clean the crisping tray and grill rack, wash with

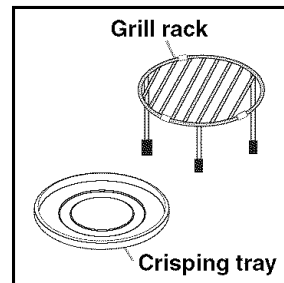

a mild cleaner, water, and a wash cloth. Dry completely. Do not use abrasive cleanser or scrubbers.

CARING FOR THE FILTERS

Grease filters (Part No. 5230W1A012B):

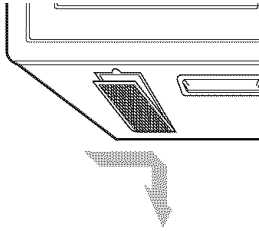

1. Unplug the microwave oven or disconnect power.

2. To remove the grease filters, slide each filter to the side. Pull the filters downward and push to the other side. The filters will drop out.

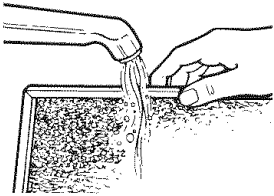

3. Soak the grease filters in hot water and a mild detergent. Scrub and swish to remove embedded dirt and grease. Rinse well and shake to dry. Do not clean filters with ammonia or corrosive oven cleaners. Do not place the filters in a dishwasher. The filters will turn black or could be damaged.

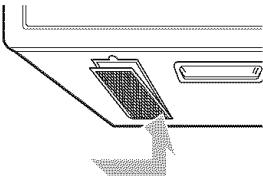

4. To replace the grease filters, slide the filters into the frame slots on one side of the opening. Push the filters upward and slide them to the other side to lock into place.

5. Plug in the microwave oven or reconnect power.

Charcoal filter (Part No. 5230W1A011B):

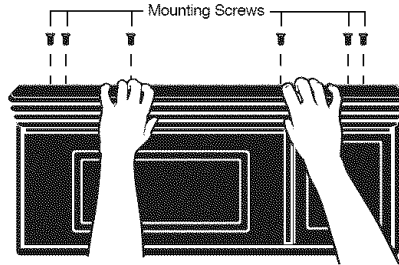

1. Unplug the microwave oven or disconnect power.

2. Remove the vent grille mounting screws.

3. Tip the vent grille forward, then lift to remove.

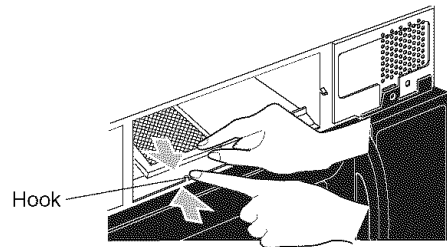

4. Lift the back of the charcoal filter. Slide the filter straight out.

CARING FOR THE FILTERS (CONT.)

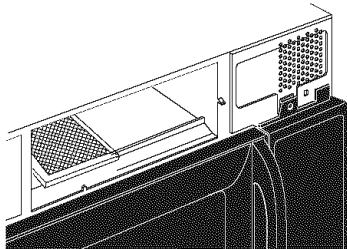

5. Slide a new charcoal filter into place. The filter should rest at the angle shown.

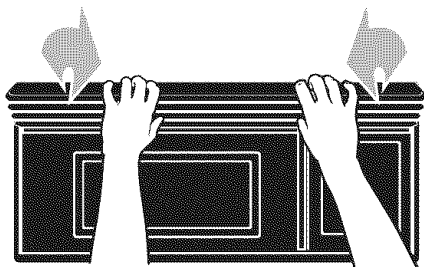

6. Slide the bottom of the vent grille into place. Push the top until it snaps into place. Replace the mounting screws.

7. Plug in the microwave oven or reconnect power.

NOTE: Do not operate the hood without the grease filters in place.

REPLACING THE COOKTOP AND OVEN LIGHTS

The cooktop light

1. Unplug the microwave oven or disconnect power.

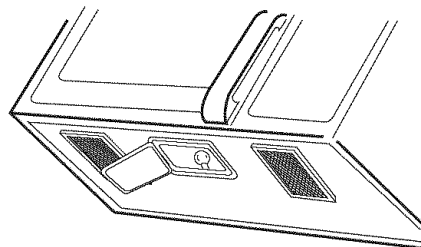

2. Remove the bulb cover mounting screws.

3. Replace bulb with candelabra-base 30-watt bulb (Part No. 6912W1Z004B) available from Sears by calling 1-800-4-MY-HOME®.

4. Plug in the microwave oven or reconnect power.

The oven light

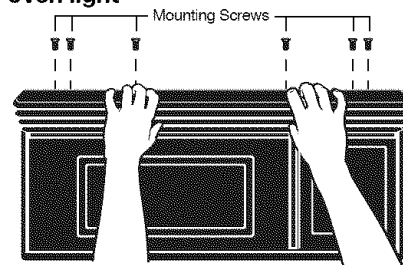

1. Unplug the microwave oven or disconnect power.

2. Remove the vent-grille mounting screws.

3. Tip the vent grille forward, then lift to remove.

REPLACING THE COOKTOP AND OVEN LIGHTS (CONT.)

Bulb holder

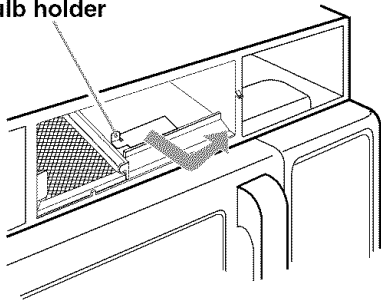

4. Lift up the bulb holder.

5. Replace the bulb with a candelabra-base 30-watt bulb (Part No. 6912W1Z004B) available from Sears by calling 1-800-4-MY-HOME®.

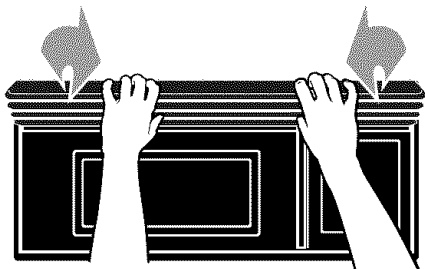

6. Slide the top of the vent grille into place. Push the bottom until it snaps into place. Replace the mounting screws.

7. Plug in the microwave oven or reconnect power.

Questions and Answers

QUESTIONS	ANSWERS
Can the microwave oven operate without the turntable or turn the turntable over to hold a large dish?	No. If the turntable is removed or turned over, you will get poor cooking results. Dishes used in the oven must fit on the turntable.
Can metal or aluminum pans be used in the microwave oven?	Aluminum foil can be used for shielding (use small, flat pieces), small skewers, and shallow foil trays (if tray is not taller than 3/4 in. [1.9 cm] deep and is filled with food to absorb microwave energy). Never allow metal to touch the walls or the door.
Is it normal for the turntable to turn in either direction?	Yes. The turntable rotates clockwise or counter-clockwise, depending on the rotation of the motor when the cooking cycle begins.
Sometimes the door of the microwave oven appears wavy. Is this normal?	This appearance is normal and does not affect the operation of the oven.
What are the humming noises the microwave oven makes when it is operating?	The sound of the transformer when the magnetron tube cycles on may be heard.
Why does the dish become hot when food is microwaved in it?	As the food becomes hot it will conduct the heat to the dish. Be prepared to use hot pads to remove after cooking.
What does "standing time" mean?	"Standing time" means that food should be removed from the oven and covered for additional time to allow it to finish cooking. This frees the oven for other cooking.
Why does steam come out of the air exhaust vent?	Steam is normally produced during cooking. The microwave oven has been designed to vent this steam out the vents.
Can popcorn be popped in the microwave oven? How are the best results achieved?	Yes. Pop packaged microwave popcorn following manufactures guidelines. Do not use regular paper bags. Do not repop unpopped kernels. Do not pop popcorn in glass cookware.

Troubleshooting

Most cooking problems often are caused by little things you can find and fix without tools of any kind. Check the lists below and on the next page before calling for assistance or service. If you still need help, call SEARS PARTS & REPAIR at 1-800-4-MY-HOME®.

MICROWAVE OVEN DOES NOT WORK

PROBLEM	CAUSE
The microwave oven will not operate and the display is blank.	<ul style="list-style-type: none">• The power supply cord is not plugged into a grounded 3 prong outlet. (See the "Electrical Requirements" section on page 5 and the "Electrical Connection" section on page 7).• A household fuse has blown or a circuit breaker has tripped.• A power failure has occurred.
The microwave oven will not run.	<ul style="list-style-type: none">• You are using the oven as a timer. Touch STOP/Clear to cancel the Kitchen Timer.• The door is not firmly closed and latched.• You did not touch START.• You did not follow directions exactly.• A function set earlier has not been cleared. Touch STOP/Clear to cancel that function.

COOKING TIMES

PROBLEM	CAUSE
Food is undercooked.	<ul style="list-style-type: none">• The electric supply to your home or wall outlets is low or lower than normal. Your electric company can tell you if the line voltage is low. Your electrician or service technician can tell you if the outlet voltage is low.• The cook power is not at the recommended setting. Check the table on page 16.
The display shows a time counting down, but the oven is not cooking.	<ul style="list-style-type: none">• The oven door is not closed completely.• You have set the controls as a kitchen timer. Touch the STOP/Clear pad and cancel the Kitchen Timer.

TURNTABLE

PROBLEM	CAUSE
The turntable will not turn.	<ul style="list-style-type: none"> • The turntable is not correctly in place. It should be correct-side up and sitting firmly on the center hub. • The support is not positioned correctly. Remove the turntable and restart the oven. If the hub still does not move, call Sears Service at 1-800-4-MY-HOME®. Cooking without the turntable will cause poor results.

AUDIBLE SIGNALS

PROBLEM	CAUSE
You do not hear the programming or end-of-cycle beep.	<ul style="list-style-type: none"> • You have not entered the correct command.

DISPLAY MESSAGES

PROBLEM	CAUSE
The display is flashing “:”.	<ul style="list-style-type: none"> • There has been a power interruption. Reset the clock. (See the “Clock” section on page 13.)

If none of these items are causing your problem, call Sears Service at 1-800-4-MY-HOME®.

Get it fixed, at your home or ours!

Your Home

For repair – **in your home** – of **all** major brand appliances, lawn and garden equipment, or heating and cooling systems, **no matter who made it, no matter who sold it!**

For the replacement parts, accessories and owner's manuals that you need to do-it-yourself.

For Sears professional installation of home appliances and items like garage door openers and water heaters.

1-800-4-MY-HOME® (1-800-469-4663)

Call anytime, day or night (U.S.A. and Canada)

www.sears.com www.sears.ca

Our Home

For repair of carry-in items like vacuums, lawn equipment, and electronics, call or go on-line for the location of your nearest **Sears Parts & Repair Center.**

1-800-488-1222

Call anytime, day or night (U.S.A. only)

www.sears.com

To purchase a protection agreement (U.S.A.) or maintenance agreement (Canada) on a product serviced by Sears:

1-800-827-6655 (U.S.A.)

1-800-361-6665 (Canada)

Para pedir servicio de reparación a domicilio, y para ordenar piezas:

1-888-SU-HOGAR®

(1-888-784-6427)

Au Canada pour service en français:

1-800-LE-FOYER^{MC}

(1-800-533-6937)

www.sears.ca

The Sears logo is displayed in a large, bold, black serif font. The word "Sears" is written in a classic, slightly stylized font. Below the word, there is a thin, curved line that underlines the letters, starting from the 'S' and ending under the 's'.