

Table of Contents

ENERGISK SBS374/215

ENERGISK SBS379/176

REFRIGERATOR SAFETY.....	1
INSTALLATION INSTRUCTIONS	3
REFRIGERATOR USE	11
REFRIGERATOR CARE.....	15
TROUBLESHOOTING.....	16
ACCESSORIES	19
ASSISTANCE OR SERVICE	19

REFRIGERATOR SAFETY

Your safety and the safety of others are very important.

We have provided many important safety messages in this manual and on your appliance. Always read and obey all safety messages.



This is the safety alert symbol.

This symbol alerts you to potential hazards that can kill or hurt you and others.

All safety messages will follow the safety alert symbol and either the word "DANGER" or "WARNING."

These words mean:

 **DANGER**

You can be killed or seriously injured if you don't immediately follow instructions.

 **WARNING**

You can be killed or seriously injured if you don't follow instructions.

All safety messages will tell you what the potential hazard is, tell you how to reduce the chance of injury, and tell you what can happen if the instructions are not followed.

IMPORTANT SAFETY INSTRUCTIONS

WARNING: To reduce the risk of fire, electric shock, or injury when using your refrigerator, follow these basic precautions:

- Plug into a grounded (earthed) outlet.
- Do not remove ground prong.
- Do not use an adapter.
- Do not use an extension cord.
- Disconnect power before servicing.
- Replace all parts and panels before operating.
- Remove doors from your old refrigerator.
- Use nonflammable cleaner.
- Keep flammable materials and vapors, such as gasoline, away from refrigerator.
- Use two or more people to move and install refrigerator.
- Disconnect power before installing ice maker (on ice maker kit ready models only).
- A qualified service technician must install the water line and ice maker.
- Use a sturdy glass when dispensing ice (on some models).
- This appliance is not intended for use by persons (including children) with reduced physical, sensory or mental capabilities, or lack of experience and knowledge, unless they have been given supervision or instruction concerning use of the appliance by a person responsible for their safety.
- Children should be supervised to ensure that they do not play with the appliance.
- If the power supply cord is damaged, it must be replaced by the manufacturer or its service agent or a similarly qualified person in order to avoid a hazard.
- Do not store explosive substances, such as aerosol cans with a flammable propellant, in this appliance.
- This appliance is intended to be used in household and similar applications such as: staff kitchen areas in shops, offices and other working environments; farm houses and by clients in hotels, motels and other residential type environments; bed and breakfast type environments; and catering and similar non-retail applications.

SAVE THESE INSTRUCTIONS

Proper Disposal of Your Old Refrigerator

! WARNING

Suffocation Hazard

Remove doors from your old refrigerator.

Failure to do so can result in death or brain damage.

IMPORTANT: Child entrapment and suffocation are not problems of the past. Junked or abandoned refrigerators are still dangerous – even if they will sit for “just a few days.” If you are getting rid of your old refrigerator, please follow these instructions to help prevent accidents.

Before You Throw Away Your Old Refrigerator or Freezer:

- Take off the doors.
- Leave the shelves in place so that children may not easily climb inside.

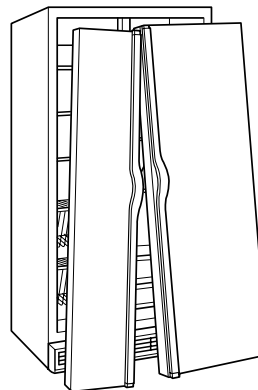

INSTALLATION INSTRUCTIONS

Unpack the Refrigerator

WARNING

Excessive Weight Hazard

Use two or more people to move and install refrigerator.

Failure to do so can result in back or other injury.

Remove packaging materials. Do not use sharp instruments, rubbing alcohol, flammable fluids, or abrasive cleaners to remove tape or glue. These products can damage the surface of your refrigerator. For more information, see "Refrigerator Safety."

When Moving Your Refrigerator:

Your refrigerator is heavy. When moving the refrigerator for cleaning or service, be sure to cover the floor with cardboard or hardboard to avoid floor damage. Always pull the refrigerator straight out when moving it. Do not wiggle or "walk" the refrigerator when trying to move it, as floor damage could occur.

Important information to know about glass shelves and covers:

Do not clean glass shelves or covers with warm water when they are cold. Shelves and covers may break if exposed to sudden temperature changes or impact, such as bumping. Tempered glass is designed to shatter into many small, pebble-size pieces. This is normal. Glass shelves and covers are heavy. Use both hands when removing them to avoid dropping.

Door Removal, Leveling and Alignment

Gather the required tools and parts and read all instructions before starting installation. Save these instructions for future reference.

NOTE: Before moving your product into your home, measure the doorway of your home to see whether you need to remove the refrigerator and freezer doors. If door removal is necessary, see the instructions below.

IMPORTANT: Before you begin, turn the refrigerator control OFF. Unplug refrigerator or disconnect power.

TOOLS NEEDED:

Phillips screwdriver, 3/16" hex key, 1/4" hex-head socket wrench, 1/4" and 5/16" open-ended wrenches or adjustable wrench, internal star drive or 3/8" hex-head socket wrench



⚠ WARNING

Electrical Shock Hazard

Disconnect power before removing doors.
Failure to do so can result in death or electrical shock.

4 Top Left Hinge

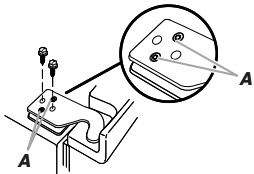

Do Not Remove Screws A

5 Door Removal



6 Top Right Hinge

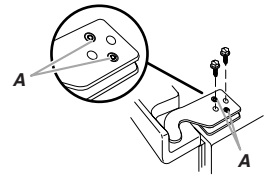

Do Not Remove Screws A

3 Wiring Connection

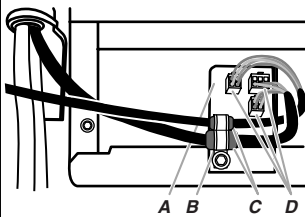

- A. Electrical Housing
- B. Wiring Clip
- C. Grommets
- D. Wiring Plugs

2 Water Dispenser Tubing Connection

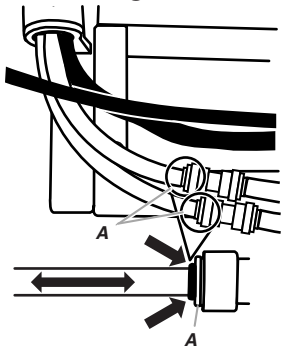

A. Face of Fitting

7 Bottom Hinge

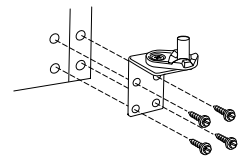

8 Leveling

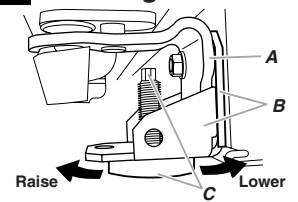

- A. Bottom Hinge
- B. Leveler Bracket
- C. Leveling Foot

9 Door Alignment

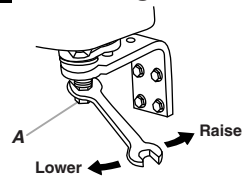

A. Alignment Screw

1 Base Grille

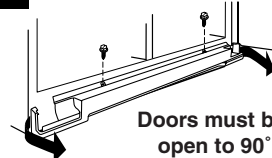

Remove the Doors

! WARNING



Electrical Shock Hazard

Disconnect power before removing doors.

Failure to do so can result in death or electrical shock.

1. Unplug refrigerator or disconnect power.
2. Open both doors to 90°. Remove the base grille by removing the two screws, then pulling out on the outside corners. See Graphic 1.
NOTE: The doors must only be opened to 90°. If they are opened all the way, the base grille will not come off.
3. Remove food, the ice storage bin, and any adjustable door or utility bins from doors.
4. On dispenser models, disconnect the water tubing, located behind the base grille on the freezer door side. See Graphic 2.
 - Press the colored outer ring against the face of fitting and pull the water tubing free.
5. Disconnect the wiring, located behind the base grille on the freezer door side. See Graphic 3.
 - Remove the wiring clip using a 1/4" hex-head socket wrench.
 - Pull the electrical housing out from under the refrigerator. Disconnect the wiring plugs from the housing.
6. Close both doors and keep them closed until you are ready to lift them free from the cabinet.
7. Use a 3/16" hex key to remove the top left hinge screws as shown. See Graphic 4.
IMPORTANT: Do not remove either screw A.
8. Use an internal star drive or a 3/8" hex-head socket wrench to remove the bottom left hinge screws. See Graphic 7.
IMPORTANT: This requires two people - one to hold the freezer door in place and another to remove the hinge screws.
NOTE: A leveler bracket is mounted behind the bottom hinge. Make sure that the leveler bracket is replaced when reinstalling the hinge.

! WARNING

Excessive Weight Hazard

Use two or more people to lift the freezer door.

Failure to do so can result in back or other injury.

9. Remove the freezer door. See Graphic 5. The water tubing (on dispenser models) and wiring remain attached to the freezer door, along with the bottom left hinge.
IMPORTANT: Rest the door on its side on a soft, clean surface, such as a towel, blanket or piece of cardboard. This will help avoid damaging the door, water tubing and wiring.

10. Use a 3/16" hex key to remove the top right hinge screws as shown. See Graphic 6.

IMPORTANT: Do not remove either screw A.

11. Lift the refrigerator door straight up off bottom hinge.
12. It may not be necessary to remove the bottom right hinge in order to move the refrigerator through a doorway.
 - If necessary, use an internal star drive or a 3/8" hex-head socket wrench to remove the bottom right hinge. See Graphic 7.

NOTE: A leveler bracket is mounted behind the bottom hinge. If you remove the hinge, make sure that the leveler bracket is replaced when reinstalling the hinge.

Replace the Doors and Hinges

1. Replace the bottom right hinge, if removed. Make sure that the leveler bracket is assembled behind the hinge. Tighten screws.
NOTE: When the screws are tightened properly, there should not be any gaps between the refrigerator, leveler bracket and hinge.

! WARNING

Excessive Weight Hazard

Use two or more people to lift the freezer door.

Failure to do so can result in back or other injury.

2. Hold the freezer door in place in order to replace the bottom left hinge. For easiest access, hold the door open 90°. Make sure that the leveler bracket is assembled behind the hinge. Tighten screws.
IMPORTANT: This requires two people - one to hold the freezer door and another to reinstall the hinge screws.
NOTE: When the screws are tightened properly, there should not be any gaps between the refrigerator, leveler bracket and hinge.
3. Once the bottom left hinge has been replaced, close the freezer door and make sure it is properly seated on the hinge. Assistance may be needed.
NOTE: Provide additional support for the doors while the top hinges are being replaced. Do not depend on the door magnets to hold the doors in place while you are working.
4. Align and replace the top left hinge as shown. See Graphic 4. Tighten screws.
5. Reconnect water tubing (on dispenser models) and wiring.
IMPORTANT: Do not intertwine the water tubing and wiring bundles when reconnecting them.
 - On dispenser models, push the larger 5/16" (7.94 mm) water tube into the blue fitting until it stops, then push the smaller 1/4" (6.35 mm) water tube into the green fitting until it stops. See Graphic 2.

NOTE: On dispenser models, there are two wiring bundles that run underneath the freezer - a large bundle with a large grommet and two white plugs at the end, and a small bundle with a small grommet and one yellow plug at the end. Reconnect the wiring plugs to the electrical housing, then push the housing back under the refrigerator. Align the left hole in the front lip of the housing with the right hole in the refrigerator's base crossbar. See Graphic 3.

- Reinstall the wiring clip over the grommets. On dispenser models, first install the smaller grommet into the top of the clip, then install the larger grommet into the bottom of the clip (closest to the screw hole). See Graphic 3.
- Align the clip's screw hole with the left hole in the electrical housing and the right hole in the crossbar, and screw in the clip using a single screw. Tighten screw. See Graphic 3.

IMPORTANT: Once connected, the wiring bundles should not be taut. Some flexibility is needed to allow the freezer door to open properly.

6. Replace the refrigerator door by lifting the door onto the bottom right hinge.
7. Align and replace the top right hinge as shown. See Graphic 6. Tighten screws.
8. Replace the ice storage bin and any adjustable door or utility bins.
9. Plug refrigerator into a grounded (earthed) outlet.

Leveling and Door Closing

Your refrigerator has two adjustable front feet — one on the right and one on the left. In most cases, the refrigerator should be steady when both feet are touching the floor. If your refrigerator seems unsteady or if you want the doors to close more easily, adjust the refrigerator's tilt using the instructions below:

1. Move the refrigerator into its final location. If necessary, open both doors to 90° and remove the base grille. See Graphic 1.
2. The two leveling feet are located on the brackets on each side of the product. See Graphic 8.

NOTE: Having someone push against the top of the refrigerator takes some weight off the leveling feet. This makes it easier to make adjustments.

3. Use a ¼" open-ended or adjustable wrench to adjust the leveling feet. Turn the leveling foot to the left to raise that side of the product, or turn it to the right to lower that side of the product.
4. Open both doors again and check that they close as easily as you like. If not, tilt the refrigerator slightly more to the rear by turning the leveling feet to the left. It may take several more turns, and you should turn both leveling feet the same amount.

NOTE: Whenever you need to move the refrigerator, turn the leveling feet to the right until they are no longer touching the ground. This will allow the refrigerator to roll more easily.

Door Alignment

A refrigerator that is not level from side-to-side may appear to have doors that are not properly aligned. If the doors appear this way, use the instructions in the previous section to check the leveling.

The doors are designed to be slightly different heights when the refrigerator is empty, in order to account for the weight of food that will be placed on the doors. If the doors are still not aligned after checking the leveling and loading the refrigerator with food, follow the steps below to adjust the door alignment.

1. If necessary, open both doors to 90° and remove the base grille. See Graphic 1.
2. Locate the alignment screw on the bottom hinge of the refrigerator door. See Graphic 9.
3. Use a 5/16" open-ended or adjustable wrench to turn the screw. To raise the refrigerator door, turn the screw to the right. To lower the door, turn the screw to the left.
4. Check that the doors are even at the top. If necessary, continue to turn the alignment screw until the doors are aligned.
5. Open both doors to 90°. Replace the base grille. See Graphic 1.

Handle Installation

PARTS INCLUDED: Handles (2), hex key, spare setscrews

NOTE: Handle mounting setscrews are preinstalled in the handle.

1. Remove handles from packaging inside the refrigerator.

NOTE: To avoid damaging the handles, place them on a towel or other soft surface.
2. Open the refrigerator door. Place the handle on the shoulder screws (located on the front of the refrigerator door), with the setscrews facing the freezer door.
3. Firmly push the handle into the door, but do not push down. Insert the short end of the hex key into each setscrew, and tighten each screw.

IMPORTANT: When the screw feels tight, tighten it an additional quarter-turn. The handle is not properly installed without this extra tightening.

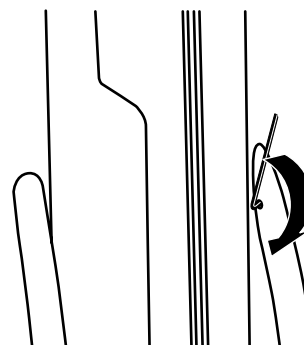

4. Open the freezer door and repeat the previous steps to install the freezer door handle, with the setscrews facing the refrigerator door.
5. Save the hex key and all instructions.

To Remove the Handles:

1. Use a hex key to loosen the setscrews, then pull the handle off of the door.
2. If necessary, use a Phillips screwdriver to remove the shoulder screws from the door.

Product Dimensions

Top View

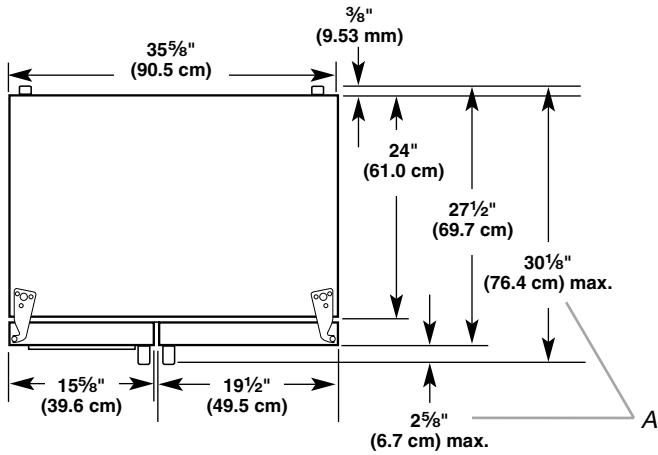

A. Dimensions may vary based on the model.

Front View

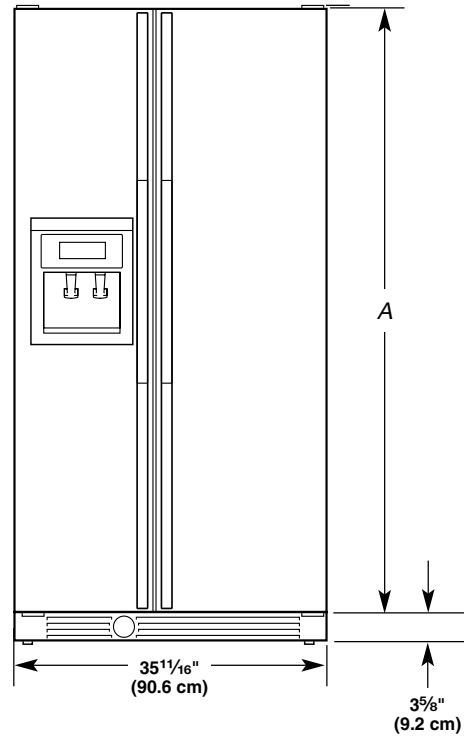

Height A

64 7/8" (164.8 cm)

Side View

- Height dimensions are shown with the leveling legs extended to the minimum height of 1/4" (6.35 mm) below the refrigerator.
- The power cord is approximately 85" (215 cm) long.

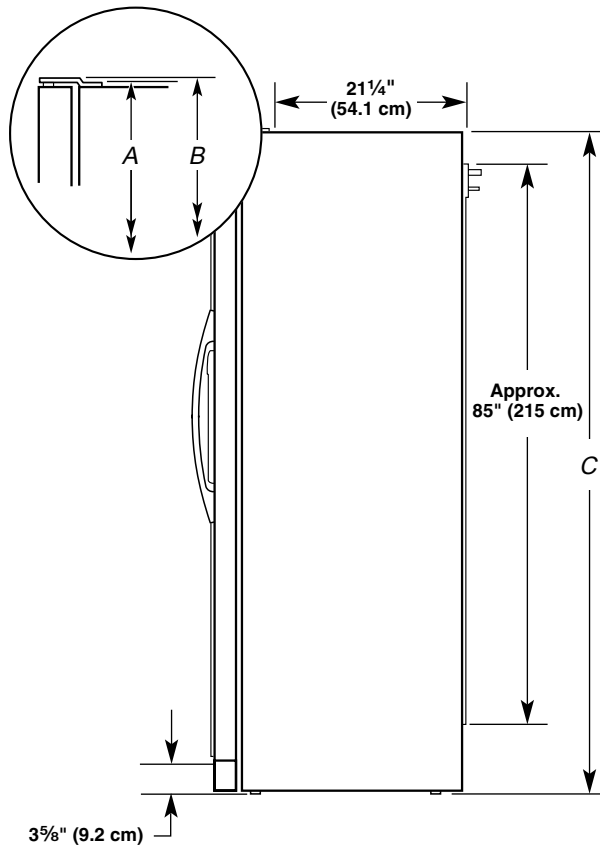

A	B	C
68 3/4" (174.6 cm)	68 7/8" (175.0 cm)	68 1/2" (174.0 cm)

When leveling legs are fully extended to 1" (25 mm) below the refrigerator, add 3/4" (19 mm) to the height dimensions.

Opening Dimensions

- Height dimensions are shown with the leveling legs extended to the minimum height of $\frac{1}{4}$ " (6.35 mm) below the refrigerator.

NOTE: When leveling legs are fully extended to 1" (25 mm) below the refrigerator, add $\frac{3}{4}$ " (19 mm) to the height dimensions.

- Minimum fixed wall position is $13\frac{1}{4}$ " (34 cm) from the freezer door and $16\frac{1}{2}$ " (42 cm) from the refrigerator door.

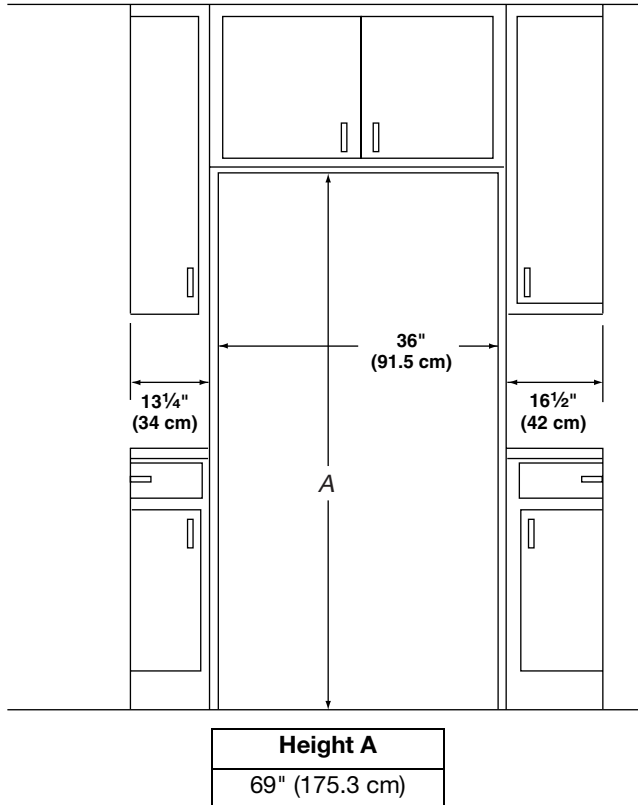

Door Swing Dimensions

Location must permit doors to open to a minimum of 150°. Allow $13\frac{1}{4}$ " (34 cm) minimum space between the side wall and the freezer side of the refrigerator. Allow $16\frac{1}{2}$ " (42 cm) minimum space between the side wall and the refrigerator side.

NOTE: Dimensions may vary based on model.

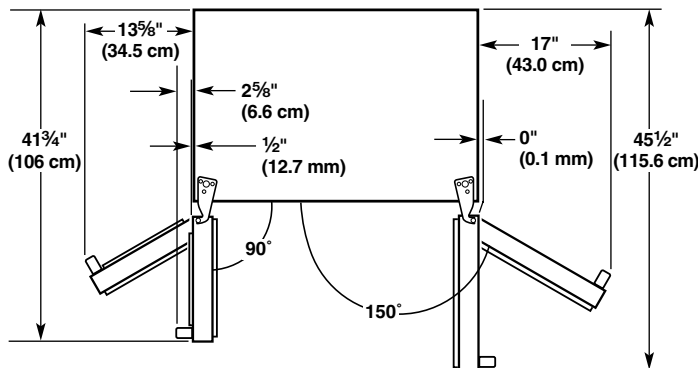

Location Requirements

⚠ WARNING



Explosion Hazard

Keep flammable materials and vapors, such as gasoline, away from refrigerator.

Failure to do so can result in death, explosion, or fire.

NOTES:

- The cabinet depth refrigerator can be installed into a recessed opening, at the end of cabinets or as a freestanding refrigerator.
- If you are installing the refrigerator to fit flush with the front of the base cabinets, all shoe molding and baseboards must be removed from the rear of the refrigerator opening. Allow for 1" (2.54 cm) of space behind the refrigerator.
- For full-overlay cabinet doors, the height of the opening must be $69\frac{1}{8}$ " (175.6 cm).
- Location should permit doors to open fully. See the "Door Swing Dimensions" section.
- Do not install the refrigerator near an oven, radiator, or other heat source, nor in a location where the temperature will fall below 55°F (13°C).
- Floor must support refrigerator weight (more than 600 lbs [272 kg], door panels and contents).

Electrical Requirements

⚠ WARNING



Electrical Shock Hazard

Plug into a grounded (earthed) outlet.

Do not remove ground prong.

Do not use an adapter.

Do not use an extension cord.

Failure to follow these instructions can result in death, fire, or electrical shock.

Before you move your refrigerator into its final location, it is important to make sure you have the proper electrical connection:

Recommended Grounding Method

A 115 Volt 60 Hz. (Plug 1), 220/240 Volt 50 Hz. (Plugs 2 or 3), or 220 Volt 60 Hz. (Plug 3) AC only 10-amp fused and grounded (earthed) electrical supply is required.

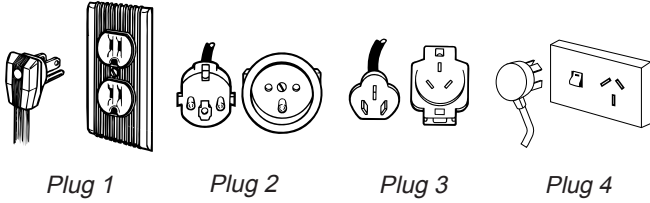

It is recommended that a separate circuit serving only your refrigerator be provided. Use an outlet that cannot be turned off by a switch or pull chain. Do not use an extension cord.

⚠ WARNING



Electrical Shock Hazard

Disconnect power before servicing.

Replace all parts and panels before operating.

Failure to do so can result in death or electrical shock.

NOTE: Before performing any type of installation, cleaning, or removing a light bulb, turn the control, (Thermostat, Refrigerator or Freezer Control depending on the model) to OFF and then disconnect the refrigerator from the electrical source. When you are finished, reconnect the refrigerator to the electrical source and reset the control (Thermostat, Refrigerator or Freezer Control depending on the model) to the desired setting.

For Australia and New Zealand:

Your new appliance has been especially manufactured to meet all Australian Standards and Conditions.

Some notations in the installation instructions may refer to electrical requirements in other countries, so we draw your particular attention to these specific notes.

Your appliance needs to be plugged into a 230/240 Volt 50 Hz. 10-amp (Plug 4) AC only earthed outlet.

Water Supply Requirements

(on some models)

Gather the required tools and parts before starting installation. Read and follow the instructions provided with any tools listed here.

TOOLS NEEDED:

- Flat-blade screwdriver
- 1/4" Nut driver
- 7/16" and 1/2" Open-end or two adjustable wrenches
- 1/4" Drill bit
- Cordless drill

NOTE: Your refrigerator dealer has a kit available with a 1/4" (6.35 mm) saddle-type shutoff valve, a union, and copper tubing. Before purchasing, make sure a saddle-type valve complies with your local plumbing codes. Do not use a piercing-type or 3/16" (4.76 mm) saddle valve which reduces water flow and clogs more easily.

IMPORTANT:

- All installations must meet local plumbing code requirements.
- Use copper tubing and check for leaks. Install copper tubing only in areas where the household temperatures will remain above freezing.

Water Pressure

A potable cold water supply with water pressure of between 30 and 87 psi (207 and 600 kPa) is required to operate the water dispenser and ice maker. If you have questions about your water pressure, call a licensed, qualified plumber.

Reverse Osmosis Water Supply

IMPORTANT: The pressure of the water supply coming out of a reverse osmosis system going to the water inlet valve of the refrigerator needs to be between 30 and 87 psi (207 and 600 kPa).

If a reverse osmosis water filtration system is connected to your cold water supply, the water pressure to the reverse osmosis system needs to be a minimum of 40 to 60 psi (276 to 414 kPa).

If the water pressure to the reverse osmosis system is less than 40 to 60 psi (276 to 414 kPa):

- Check to see whether the sediment filter in the reverse osmosis system is blocked. Replace the filter if necessary.
- Allow the storage tank on the reverse osmosis system to refill after heavy usage.
- If your refrigerator has a water filter, it may further reduce the water pressure when used in conjunction with a reverse osmosis system. Remove the water filter. See "Water Filtration System."

If you have questions about your water pressure, call a licensed, qualified plumber.

Connect Water Supply

(on some models)

Read all directions before you begin.

IMPORTANT:

- Plumbing shall be installed in accordance with the International Plumbing Code and any local codes and ordinances.
- Use copper tubing or Whirlpool supply line, Part Number 8212547RP, and check for leaks.
- Install tubing only in areas where temperatures will remain above freezing.
- For Australia and New Zealand: If water pressure exceeds 599 kPa (87 psi), a pressure-limiting device must be fitted by a licensed plumber.

Tools needed:

Gather the required tools and parts before starting installation.

- Flat-blade screwdriver
- 7/16" and 1/2" open-end wrenches or two adjustable wrenches
- 1/4" nut driver

Connect to Water Line

IMPORTANT: If you turn the refrigerator on before the water line is connected, turn the ice maker OFF.

1. Unplug refrigerator or disconnect power.
2. Turn OFF main water supply. Turn ON nearest faucet long enough to clear line of water.

- Use a quarter-turn shutoff valve or the equivalent, served by a 1/2" copper household supply line.

NOTE: To allow sufficient water flow to the refrigerator, a minimum 1/2" size copper household supply line is recommended.

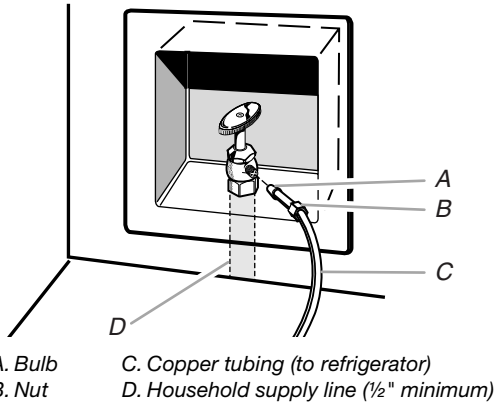

- Now you are ready to connect the copper tubing to the shutoff valve. Use 1/4" (6.35 mm) OD soft copper tubing to connect the shutoff valve and the refrigerator.

- Ensure that you have the proper length needed for the job. Be sure both ends of the copper tubing are cut square.
- Slip compression sleeve and compression nut onto copper tubing as shown. Insert end of tubing into outlet end squarely as far as it will go. Screw compression nut onto outlet end with adjustable wrench. Do not overtighten.

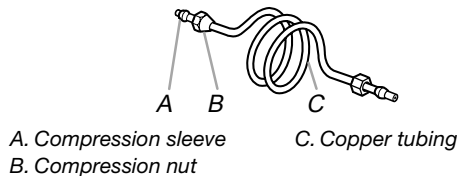

- Place the free end of the tubing into a container or sink, and turn on main water supply to flush out tubing until water is clear. Turn off shutoff valve on the water pipe.

NOTE: Always drain the water line before making the final connection to the inlet of the water valve, to avoid possible water valve malfunction.

- Bend the copper tubing to meet the water line inlet, which is located on the back of the refrigerator cabinet as shown. Leave a coil of copper tubing to allow the refrigerator to be pulled out of the cabinet or away from the wall for service.

Connect to Refrigerator

Style 1

- Unplug refrigerator or disconnect power.
- Remove and discard the short, black plastic part from the end of the water line inlet.
- Thread the nut onto the end of the tubing. Tighten the nut by hand. Then tighten it with a wrench two more turns. Do not overtighten.

NOTE: To avoid rattling, be sure the copper tubing does not touch the cabinet's side wall or other parts inside the cabinet.

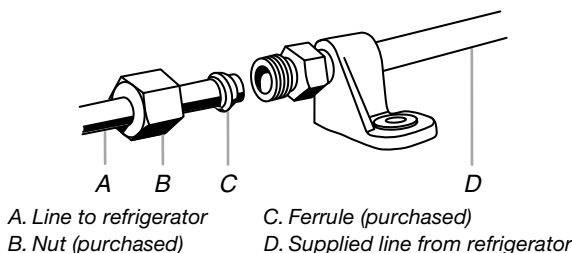

- Install the water supply tube clamp around the water supply line to reduce strain on the coupling.
- Turn shutoff valve ON.
- Check for leaks. Tighten any connections (including connections at the valve) or nuts that leak.

Style 2

- Unplug refrigerator or disconnect power.
- Remove and discard the plastic part that is attached to the inlet of the water valve.
- Attach the copper tube to the valve inlet using a compression nut and sleeve as shown. Tighten the compression nut. Do not overtighten.
- Use the tube clamp on the back of the refrigerator to secure the tubing to the refrigerator as shown. This will help avoid damage to the tubing when the refrigerator is pushed back against the wall.
- Turn shutoff valve ON.
- Check for leaks. Tighten any connections (including connections at the valve) or nuts that leak.

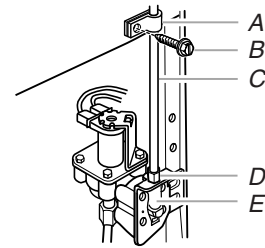

- On some models, the ice maker is equipped with a built-in water strainer. If your water conditions require a second water strainer, install it in the 1/4" (6.35 mm) water line at either tube connection. Obtain a water strainer from your nearest appliance dealer.

Style 3

- Unplug refrigerator or disconnect power.
- Remove and discard the black nylon plug from the gray water tube on the rear of the refrigerator.
- If the gray water tube supplied with the refrigerator is not long enough, a 1/4" x 1/4" (6.35 mm x 6.35 mm) coupling is needed in order to connect the water tubing to an existing household water line. Thread the provided nut onto the coupling on the end of the copper tubing.

NOTE: Tighten the nut by hand. Then tighten it with a wrench two more turns. Do not overtighten.

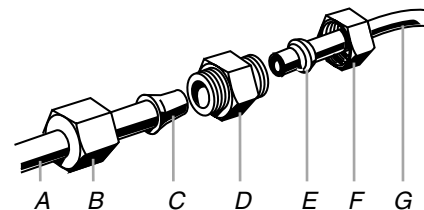

- Turn shutoff valve ON.
- Check for leaks. Tighten any nuts or connections (including connections at the valve) that leak.

Style 4

1. Unplug refrigerator or disconnect power.
2. Connect the supplied hose to the water valve outlet on the back of the refrigerator.

Complete the Installation

⚠ WARNING



Electrical Shock Hazard

Plug into a grounded (earthed) outlet.

Do not remove ground prong.

Do not use an adapter.

Do not use an extension cord.

Failure to follow these instructions can result in death, fire, or electrical shock.

1. Plug into a grounded (earthed) outlet.
2. Flush the water system. See “Prepare the Water System” or “Water and Ice Dispensers.”

NOTE: Allow 24 hours to produce the first batch of ice. Allow 3 days to completely fill ice container.

Install Air Filter (on some models)

On some models, your refrigerator’s accessory packet includes an air filter, which must be installed prior to use. On some models, the air filter is already installed at the factory.

The air filter reduces the buildup of odors. This helps to maintain a cleaner environment inside the refrigerator.

Installing the Air Filter (on some models)

The filter should be installed behind the vented door along the rear interior wall at the top of the refrigerator compartment.

1. Remove the air filter from its packaging.
2. Lift open the vented door.
3. Snap the filter into place.

Replacing the Air Filter

The disposable air filter should be replaced every 6 months. The refrigerator has a status indicator to help remind you when to replace the filter. See “Using the Controls” for more information. To order a replacement air filter, see “Accessories.”

1. Remove the old air filter by squeezing in on the side tabs.
2. Install the new air filter using the instructions in the previous section.

REFRIGERATOR USE

Using the Controls

The refrigerator and freezer controls are located on the panel on the front of the freezer door.

IMPORTANT: The display screen on the control panel will automatically dim and enter “sleep” mode when both doors have been closed and the control buttons and (on some models) the dispenser pad have not been used for 2 minutes or more. While in “sleep” mode, the first press of a control button will only reactivate the display screen, without changing any settings. After reactivation, changes to any settings can then be made. If no changes are made within 2 minutes, the display will re-enter “sleep” mode.

- Open either door or touch any button on the control panel to activate the display screen. The home screen will appear as shown.

On models with a dispenser:

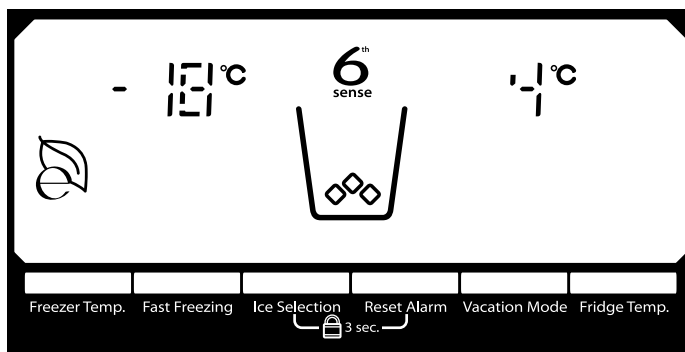

On models without a dispenser:

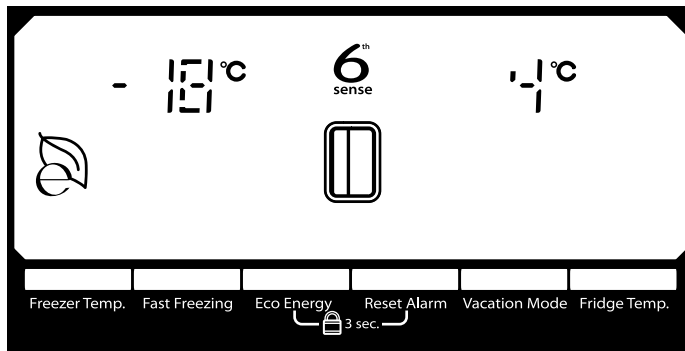

Adjusting the Controls

For your convenience, your refrigerator and freezer controls are preset at the factory. When you first install your refrigerator, make sure that the controls are still set to the default settings. The factory recommended set points are 4°C for the refrigerator and -18°C for the freezer.

IMPORTANT:

- Wait 24 hours before you put food into the refrigerator. If you add food before the refrigerator has cooled completely, your food may spoil.

NOTE: Adjusting the set points to a colder setting will not cool the compartments any faster.

- If the temperature is too warm or too cold in the refrigerator or freezer, first check the air vents to be sure they are not blocked before adjusting the controls.

- The preset settings should be correct for normal household usage. The controls are set correctly when milk or juice is as cold as you like and when ice cream is firm.
- Wait at least 24 hours between adjustments. Recheck the temperatures before other adjustments are made.

To Adjust the Set Points:

The temperature set points appear on the display screen.

- To adjust the refrigerator set point, press FRIDGE TEMP.
The set point range for the refrigerator is 2°C to 6°C.
- To adjust the freezer set point, press FREEZER TEMP.
The set point range for the freezer is -24°C to -18°C.

NOTE: Each button press advances the temperature setting 1° higher. After reaching the highest possible set point, the next button press reverts the setting to the lowest possible set point, and then each additional press raises the setting 1° higher. When adjusting temperature set points, use the following chart as a guide.

CONDITION:	TEMPERATURE ADJUSTMENT:
REFRIGERATOR too cold	FRIDGE 1° higher
REFRIGERATOR too warm	FRIDGE 1° lower
FREEZER too cold	FREEZER 1° higher
FREEZER too warm / Too little ice	FREEZER 1° lower

Eco Energy

When the most economic and energy-efficient temperature setting (6°C for the refrigerator or -18°C for the freezer) is selected, the Eco Energy icon appears on the display screen. There is one icon for each compartment.



NOTE: On models without a dispenser, you can automatically select the Eco Energy settings by pressing the ECO ENERGY button on the control panel. Pressing the button a second time will restore the previous temperature set points.

Cooling On/Off

Your refrigerator and freezer will not cool when cooling is turned off.

- To turn cooling off, press and hold VACATION MODE for 3 seconds.
When cooling is off, “-” will appear on the display screen in both of the temperature displays. Also, the interior lights turn off.
- Press and hold VACATION MODE for 3 seconds again to turn cooling back on.
The temperature set points reset to the default settings (4°C for the refrigerator and -18°C for the freezer) when cooling has been turned back on.

Vacation Mode

Vacation Mode is designed to help save energy when the refrigerator will not be used for a few days.

IMPORTANT: Do not use Vacation Mode if perishable foods are stored in the refrigerator compartment. Such items will likely spoil if Vacation Mode is active for more than a few hours.

In Vacation Mode, the refrigerator temperature set point is changed to 12°C and the interior lights turn off. Also, on models with a dispenser, the dispenser light turns off and the dispenser is disabled.

- Press VACATION MODE to turn on Vacation Mode. The refrigerator temperature display changes to “-” and the Vacation Mode icon appears on the display screen.



- To turn off the Vacation Mode feature, press VACATION MODE again or press FRIDGE TEMP. (A single press of FRIDGE TEMP will simply restore the previous refrigerator set point; additional presses will adjust the setting.) The Vacation Mode icon will disappear when the feature is off.

The Control Lock

The control panel can be turned off for easy cleaning or to avoid unintentional changes by small children and pets.

NOTE: The lock feature does not shut off power to the refrigerator or to the ice maker. It simply deactivates the control buttons and dispenser pad, and turns off the dispenser light. To turn off the ice maker, see “Ice Maker and Storage Bin.”

The display screen indicates when the control panel is locked.



On models with a dispenser:

- Press and hold ICE SELECTION and RESET ALARM for 3 seconds to lock the control panel and dispenser.
IMPORTANT: To avoid unintentionally changing other settings, be sure to press both buttons at exactly the same time.
- Press and hold ICE SELECTION and RESET ALARM a second time to unlock the control panel and dispenser.

On models without a dispenser:

- Press and hold ECO ENERGY and RESET ALARM for 3 seconds to lock the control panel.
IMPORTANT: To avoid unintentionally changing other settings, be sure to press both buttons at exactly the same time.
- Press and hold ECO ENERGY and RESET ALARM a second time to unlock the control panel.

Air Filter Status Indicator

The air filter status indicator, located on the control panel's display screen, will help you know when to change your air filter.



- When the air filter is in good condition, the air filter status indicator icon does not appear on the control panel.
- When the control panel's air filter status indicator icon appears in orange, this tells you that it is almost time to change the air filter. It is recommended that you order a replacement filter when the orange icon appears.
- Replace the air filter when the air filter status indicator icon changes from orange to red. The filter should be replaced at least every 6 months.

See “Install Air Filter” for replacing instructions.

- After changing the air filter, reset the status indicator by pressing and holding the RESET ALARM button for 3 seconds. When the system is reset, the air filter status indicator icon will disappear from the display screen.

Additional Features

Fast Freezing

The Fast Freezing feature assists with temporary periods of heavy ice use by increasing ice production over a 24-hour period.

IMPORTANT: This feature only works if the ice maker is turned on. See “Ice Maker and Storage Bin.”

- Press FAST FREEZING to turn on the Fast Freezing feature. When the feature is on, the displayed freezer set point will change to -24°C and the Fast Freezing icon will appear on the dispenser display screen.



The Fast Freezing setting will remain on for 24 hours unless manually turned off.

- To manually turn off the Fast Freezing feature, press FAST FREEZING again or press FREEZER TEMP. (A single press of FREEZER TEMP will simply restore the previous freezer set point; additional presses will adjust the setting.) The Fast Freezing icon will disappear when the feature is off.

NOTE: If increased ice production is desired at all times, change the freezer set point to a lower setting. Setting the freezer to a colder temperature may make some foods, such as ice cream, harder.

6th Sense Temperature Management

The 6th Sense feature assists with regulating the temperature inside the refrigerator. If a large quantity of warm food is placed in the refrigerator or warm air enters the refrigerator while the door is held open, the 6th Sense system activates to quickly restore the temperature to the set point.



NOTE: The 6th Sense system is always on when your refrigerator is operating. You do not need to press any buttons to activate it. The 6th Sense icon on the dispenser display screen indicates that the feature is functioning properly.

Door Ajar Alarm

The Door Ajar Alarm feature sounds an alarm when either the refrigerator or freezer door is open for 2 minutes and the product cooling is turned on. The alarm will repeat every 2 minutes. Close both doors to turn it off. The feature then resets and will reactivate when either door is left open again for 2 minutes.

NOTE: To mute the audible alarm while keeping the doors open, such as while cleaning the inside of the refrigerator, press RESET ALARM on the control panel. The alarm sound will be turned off for 2 minutes, but the red Alarm icon will still be displayed on the control panel.



Power Outage Indicator

The power outage indicator lets you know if the power supply to your refrigerator has been cut off. When power is restored, the red Power Outage icon will appear on the display screen.



When the indicator is on, the freezer temperature display will flash, showing the actual temperature inside the freezer compartment.

- To turn off the indicator, press RESET ALARM on the control panel. The Power Outage icon will disappear, and the freezer temperature display will return to showing the set point.

Convertible Drawer Temperature Control

(on some models)

The control can be adjusted to properly chill meats or vegetables. The air inside the pan is cooled to avoid “spot” freezing and can be set to keep meats at the National Livestock and Meat Board recommended storage temperatures of 28° to 32°F (-2° to 0°C). The convertible vegetable/meat drawer control comes preset at the lowest meat setting.

To store meat:

Set the control to one of the three MEAT settings to store meat at its optimal storage temperature.

To store vegetables:

Set the control to VEG to store vegetables at their optimal storage temperatures.

NOTE: If food starts to freeze, move the control to the left (less cold). Remember to wait 24 hours between adjustments.

Crisper Humidity Control

(on some models)

You can control the amount of humidity in the moisture-sealed crisper. Adjust the control to any setting between LOW and HIGH.

LOW (open) for best storage of fruits and vegetables with skins.

HIGH (closed) for best storage of fresh, leafy vegetables.

Water and Ice Dispensers

(on some models)

IMPORTANT: After connecting the refrigerator to a water source or replacing the water filter, flush the water system. Use a sturdy container to depress and hold the water dispenser pad for 5 seconds, then release it for 5 seconds. Repeat until water begins to flow. Once water begins to flow, continue depressing and releasing the dispenser pad (5 seconds on, 5 seconds off) until a total of 3 gal. (12 L) has been dispensed. This will flush air from the filter and water dispensing system, and prepare the water filter for use. Additional flushing may be required in some households. As air is cleared from the system, water may spurt out of the dispenser.

NOTES:

- The dispensing system will not operate when the freezer door is open.
- Allow 24 hours for the refrigerator to cool down and chill water.
- Allow 24 hours to produce the first batch of ice. Discard the first three batches of ice produced.
- The display screen on the control panel will automatically dim and enter “sleep” mode when both doors have been closed and the control buttons and dispenser pad have not been used for 2 minutes or more. While in “sleep” mode, the first press of a control button will only reactivate the display screen, without changing any settings. After reactivation, changes to any settings can then be made. If no changes are made within 2 minutes, the display will re-enter “sleep” mode.

The Water Dispenser

IMPORTANT: Dispense enough water every week to maintain a fresh supply.

To Dispense Water:

1. Press ICE SELECTION on the control panel until the Water icon appears on the display screen.



2. Press a sturdy glass against the dispenser pad.
3. Remove the glass to stop dispensing.

IMPORTANT: Limit water dispensing time to a maximum of 2 minutes at a time.

The Ice Dispenser

Ice dispenses from the ice maker storage bin in the freezer when the dispenser lever is pressed. To turn off the ice maker, see “Ice Maker and Storage Bin.”

Your ice maker can produce both crushed and cubed ice. Before dispensing ice, select which type of ice you prefer by pressing the ICE SELECTION button.

The display screen indicates which type of ice is selected.

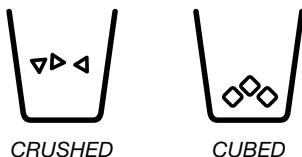

For crushed ice, cubes are crushed before being dispensed. This may cause a slight delay when dispensing crushed ice. Noise from the ice crusher is normal, and pieces of ice may vary in size. When changing from crushed to cubed, a few ounces of crushed ice will be dispensed along with the first cubes.

To Dispense Ice:

1. Make sure the desired type of ice is selected. To switch between cubed and crushed, press ICE SELECTION.

⚠ WARNING



Cut Hazard

Use a sturdy glass when dispensing ice.

Failure to do so can result in cuts.

2. Press a sturdy glass against the dispenser pad. Hold the glass close to the dispenser opening so ice does not fall outside of the glass.
IMPORTANT: You do not need to apply a lot of pressure to the pad in order to activate the ice dispenser. Pressing hard will not make the ice dispense faster or in greater quantities.
3. Remove the glass to stop dispensing.
NOTE: Ice may continue to dispense for up to 10 seconds after removing the glass from the pad. The dispenser may continue to make noise for a few seconds after dispensing.

IMPORTANT: Limit ice dispensing time to a maximum of 2 minutes at a time.

The Dispenser Light

When you use the dispenser, the light will automatically turn on. When you stop using the dispenser, the light will automatically fade to a lower intensity.

NOTE: The dispenser light will turn off when Vacation Mode is active or when the Control Lock is turned on. See “Using the Controls” for more information.

The dispenser lights are LEDs that cannot be changed. If it appears that your dispenser lights are not working, see “Troubleshooting” for more information.

The Dispenser Lock

The dispenser can be turned off for easy cleaning or to avoid unintentional dispensing by small children and pets.

See “The Control Lock” in the “Using the Controls” section.

Ice Maker and Storage Bin

(on some models)

- Allow 24 hours to produce the first batch of ice. Discard the first three batches of ice produced.
- The quality of your ice will be only as good as the quality of the water supplied to your ice maker. Avoid connecting the ice maker to a softened water supply. Water softener chemicals (such as salt) can damage parts of the ice maker and lead to poor quality ice. If a softened water supply cannot be avoided, make sure the water softener is operating properly and is well maintained.
- Do not use anything sharp to break up the ice in the storage bin. This can cause damage to the ice container and the dispenser mechanism.
- Do not store anything on top of or in the ice maker or storage bin.

Style 1

Turning the Ice Maker On/Off:

The On/Off switch can only be accessed when the ice storage bin has been removed. The switch is located on the freezer door, on the left side of the wall that surrounds the ice storage bin. See the following section for bin removal instructions.

- To turn on the ice maker, slide the control to the ON (left) position.
- To manually turn off the ice maker, slide the control to the OFF (right) position.

NOTE: The ice maker has an automatic shutoff to keep the storage bin from overflowing during normal operation. The ice maker sensors will automatically stop ice production, but the control will remain in the ON (left) position.

Removing and Replacing Ice Storage Bin:

1. Press down the release lever and tilt the bucket outward. Use both hands to hold the base of the storage bin, then lift it up and out.

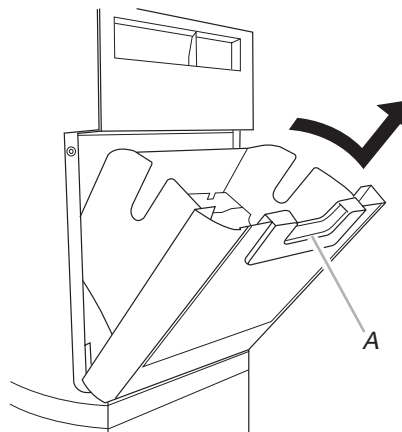

A. Release lever

NOTE: It is not necessary to turn the ice maker control to the OFF (right) position when removing the storage bin. The sensor cover (“flipper door”), located on the right wall of the freezer door, stops the ice maker from producing ice if the door is open or the storage bin is removed.

2. Replace the bin by sliding it onto the door, then tilting it back into an upright position. The release lever will click when the bin is securely in place.

Style 2

Turning the Ice Maker On/Off:

- To turn ON the ice maker, simply lower the wire shutoff arm.
- To manually turn off the ice maker, lift the wire shutoff arm to the OFF (arm up) position and listen for the click. Ice can still be dispensed, but no more can be made.

NOTE: The ice maker has an automatic shutoff to keep the storage bin from overflowing during normal operation. As ice is made, the ice cubes will fill the ice storage bin, and the ice cubes will raise the wire shutoff arm to the OFF (arm up) position. Do not force the wire shutoff arm up or down.

Removing and Replacing Ice Storage Bin:

1. Pull the covering panel up from the bottom.
2. Lift the wire shutoff arm so it clicks into the OFF (up) position.
3. Lift up the front of the storage bin and pull it out.

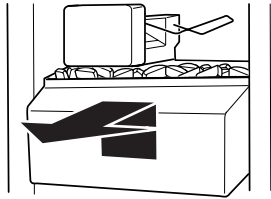

4. Replace the bin by pushing it in all the way or the dispenser will not work.
5. To restart ice production, push the wire shutoff arm down to the ON position. Make sure the door is closed tightly.

Water Filtration System (on some models)

Do not use with water that is microbiologically unsafe or of unknown quality without adequate disinfection before or after the system. Systems certified for cyst reduction may be used on disinfected waters that may contain filterable cysts.

Water Filter Status Indicator

The water filter status indicator, located on the control panel's display screen, will help you know when to change your water filter.



- When the water filter is in good condition, the water filter status indicator icon does not appear on the control panel.
- When the control panel's water filter status indicator icon appears in orange, this tells you that it is almost time to change the water filter. It is recommended that you order a replacement filter when the orange icon appears.
- Replace the water filter when the water filter status indicator icon changes from orange to red.

If water flow to your water dispenser or ice maker decreases noticeably, change the filter sooner. The filter should be replaced at least every 6 months, depending on your water quality and usage.

- After changing the water filter, reset the status indicator by pressing and holding the RESET ALARM button for 3 seconds. When the system is reset, the water filter status indicator icon will disappear from the display screen.

Changing the Water Filter

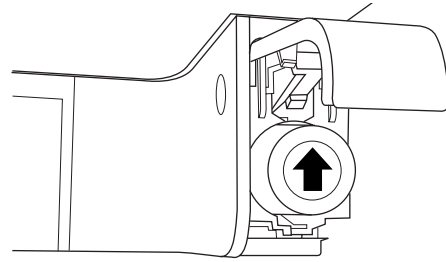

1. Locate the water filter in the top-right corner of the refrigerator compartment.
2. Lift open the filter cover door. The filter will be released and then eject as the door is opened.
3. When the door is completely open, pull the filter straight out.
NOTE: There may be some water in the filter. Some spilling may occur. Use a towel to wipe up any spills.
4. Take the new filter out of its packaging and remove the covers from the O-rings. Be sure the O-rings are still in place after the covers are removed.
5. With the arrow pointing up, align the new filter with the filter housing and slide it into place. The filter cover door will automatically begin to close as the new filter is inserted.
6. Close the filter cover door completely in order to snap the filter into place. You may need to press hard.
7. Flush the water system until a total of 3 gal. (12 L) has been dispensed. See "Water and Ice Dispensers."

REFRIGERATOR CARE

Cleaning

⚠ WARNING



Explosion Hazard

Use nonflammable cleaner.

Failure to do so can result in death, explosion, or fire.

Both the refrigerator and freezer sections defrost automatically. However, clean both sections about once a month to avoid buildup of odors. Wipe up spills immediately.

IMPORTANT: Because air circulates between both sections, any odors formed in one section will transfer to the other. You must thoroughly clean both sections to eliminate odors. To avoid odor transfer and drying out of food, wrap or cover foods tightly.

To Clean Your Refrigerator:

NOTE: Do not use abrasive or harsh cleaners such as window sprays, scouring cleansers, flammable fluids, cleaning waxes, concentrated detergents, bleaches or cleansers containing petroleum products on plastic parts, interior and door liners or gaskets. Do not use paper towels, scouring pads, or other harsh cleaning tools.

1. Unplug refrigerator or disconnect power.
2. Hand wash, rinse, and dry removable parts and interior surfaces thoroughly. Use a clean sponge or soft cloth and a mild detergent in warm water.

- Wash stainless steel and painted metal exteriors with a clean sponge or soft cloth and a mild detergent in warm water.

⚠ WARNING



Broken Glass Hazard
Do not hit refrigerator glass doors.
Protect glass surface and edges during installation or removal of doors.
Failure to do so can result in serious eye injury or minor cuts.

- On some models, wash glass door panels with a clean sponge or soft cloth and a mild detergent in warm water.
NOTE: Do not hit the glass with pots, pans, furniture, toys, or other objects. Scratching, hitting, jarring or stressing the glass may weaken its structure, causing an increased likelihood of breakage at a later date.
- There is no need for routine condenser cleaning in normal home operating environments. If the environment is particularly greasy or dusty, or there is significant pet traffic in the home, the condenser should be cleaned every 2 to 3 months to ensure maximum efficiency.

If you need to clean the condenser:

- Remove the base grille. See the “Door Removal” instructions, either in the User Instructions or the separate instruction sheet provided with your refrigerator.
 - Use a vacuum cleaner with a soft brush to clean the grille, the open areas behind the grille and the front surface area of the condenser.
 - Replace the base grille when finished.
- Plug in refrigerator or reconnect power.

Changing the Light Bulbs

NOTE: Not all bulbs will fit your refrigerator. Be sure to replace the bulb with one of the same size, shape and wattage. Replacement bulbs are available from your dealer.

- The dispenser lights are LEDs that cannot be changed.
 - On some models, the interior lights are LEDs that cannot be changed.
 - On some models, the interior lights require a 40-watt (maximum) bulb.
- Unplug refrigerator or disconnect power.
 - Remove light shield when applicable.
NOTE: To clean the light shield, wash it with warm water and liquid detergent. Rinse and dry the shield well.
 - Remove light bulb and replace with one of the same size, shape and wattage (40 watts maximum).
 - Replace light shield when applicable.
 - Plug in refrigerator or reconnect power.

TROUBLESHOOTING

Try the solutions suggested here first in order to avoid the cost of an unnecessary service call.

Refrigerator Operation

The refrigerator will not operate

⚠ WARNING



Electrical Shock Hazard
Plug into a grounded (earthed) outlet.
Do not remove ground prong.
Do not use an adapter.
Do not use an extension cord.
Failure to follow these instructions can result in death, fire, or electrical shock.

- **Power cord unplugged?** Plug into a grounded (earthed) outlet.
- **Is outlet working?** Plug in a lamp to see if the outlet is working.

- **Household fuse blown or circuit breaker tripped?** Replace the fuse or reset the circuit breaker. If the problem continues, call an electrician.
- **Are controls on?** Make sure the refrigerator controls are on. See “Using the Controls.”
- **New installation?** Allow 24 hours following installation for the refrigerator to cool completely.

NOTE: Adjusting the temperature controls to coldest setting will not cool either compartment more quickly.

The motor seems to run too much

Your new refrigerator may run longer than your old one due to its high-efficiency compressor and fans. You may notice that it runs more often when the room is warm, a large amount of food is added to either compartment, or the doors are opened often.

The refrigerator is noisy

Refrigerator noise has been reduced over the years. Due to this reduction, you may hear intermittent noises from your new refrigerator that you did not notice from your old model. Below are listed some normal sounds with an explanation.

- **Buzzing** - heard when the water valve opens to fill the ice maker
- **Pulsating** - fans/compressor adjusting to optimize performance
- **Rattling** - flow of refrigerant, water line, or from items placed on top of the refrigerator
- **Sizzling/Gurgling** - water dripping on the heater during defrost cycle
- **Popping** - contraction/expansion of inside walls, especially during initial cool-down
- **Water running** - may be heard when ice melts during the defrost cycle and water runs into the drain pan
- **Creaking/Cracking** - occurs as ice is being ejected from the ice maker mold.

The doors will not close completely

Check the following:

- Are food packages blocking the door open?
- Are all bins and shelves pushed back into the correct positions?

The doors are difficult to open

WARNING



Explosion Hazard

Use nonflammable cleaner.

Failure to do so can result in death, explosion, or fire.

- **Are the gaskets dirty or sticky?** Clean gaskets with mild soap and warm water.
- **Has the door been opened and closed within the last few seconds?** Wait at least 30 seconds to reopen the doors.

Temperature and Moisture

Temperature is too warm

Check the following:

- Are the air vents blocked in either compartment?
- Are the door(s) opened often?
- Has a large amount of food just been added to the refrigerator or freezer?
- Are the controls set correctly for the surrounding conditions?

There is interior moisture buildup

NOTE: Some moisture is normal.

- Are the air vents blocked in the refrigerator?
- Are the door(s) opened often?
- Is the room humid?
- Are the controls set correctly for the surrounding conditions?
- Was an automatic self-defrost cycle completed?

Items in meat pan/crisper are freezing

The temperature inside the meat pan/crisper may become too cold, especially when using some additional control panel features. Adjust the meat pan control to the closed setting.

Ice and Water (on some models)

The ice maker is not producing ice or not enough ice

- Is the ice maker wire shutoff arm or switch (depending on models) in the OFF position?
- Is the water line shutoff valve to the refrigerator turned on?
- **Has the ice maker just been installed? Is the freezer temperature cold enough to produce ice?** Wait 24 hours after ice maker hookup for ice production to begin. Allow 3 days after ice production begins to completely fill ice container.
- **Does the ice maker mold have water in it or has no ice been produced?** Make sure your refrigerator has been connected to a water supply and the supply shutoff valve is turned on.
- **Has a large amount of ice just been removed?** Allow 24 hours for ice maker to produce more ice.
- **Is there a water filter installed on the refrigerator?** The filter may be clogged or installed incorrectly.
- **Is an ice cube jammed in the ice maker ejector arm?** For models with an interior ice bin, remove the ice from the ejector arm with a plastic utensil.
- **Is a reverse osmosis water filtration system connected to your cold water supply?** See "Water Supply Requirements."

The ice cubes are hollow or small

This is an indication of low water pressure.

Check the following:

- Is the water shutoff valve fully open?
- Are there kinks in the water lines that could restrict water flow?
- If you are using a water filter, remove the filter and operate the dispenser. If water flow increases, the filter is clogged or incorrectly installed.
- **Is a reverse osmosis water filtration system connected to your cold water supply?** See “Water Supply Requirements.”
- If you still have questions regarding your water pressure, call a licensed, qualified plumber.

Off-taste, odor or gray color in the ice

Check the following:

- Are the plumbing connections new, causing discolored or off-flavored ice?
- Have the ice cubes been stored too long?
- Does the freezer and ice bin need to be cleaned?
- Has food in the freezer or refrigerator been wrapped properly?
- **Does the water contain minerals (such as sulfur)?** A filter may need to be installed to remove the minerals.
- **Is there a water filter installed on the refrigerator?** Gray or dark discoloration in ice indicates that the water filtration system needs additional flushing.

The ice dispenser will not operate properly

Check the following:

- Is the freezer door closed completely?
- Is the ice bin installed correctly?
- Is there ice in the bin?
- Has the ice frozen in the ice bin?
- Is ice stuck in the delivery chute?
- **Has the wrong ice been added to the bin?** Use only cubes produced by the current ice maker.
- **Has the ice melted around the auger (metal spiral) in the ice bin?** Empty the ice container. Use warm water to melt the ice if necessary.

WARNING



Cut Hazard

Use a sturdy glass when dispensing ice.

Failure to do so can result in cuts.

- **Is the ice dispenser stalling while dispensing “crushed” ice?** Change the ice button from “crushed” to “cubed.” If cubed ice dispenses correctly, depress the button for “crushed” ice and begin dispensing again.
- **Has the dispenser lever been held in too long?** Ice will stop dispensing when the arm is held in too long. Wait 3 minutes for dispenser motor to reset before using again.

The water dispenser will not operate properly

Check the following:

- Is the freezer door closed completely?
- Is the water shutoff valve not turned on, incorrectly installed or clogged?
- Is the water line connected at the source?
- Is there a kink in the home water source line?
- **Has the water system not filled?** The water system needs to be filled the first time it is used.
- **Is the refrigerator connected to a cold water line with water pressure of at least 30 psi (207 kPa)?** The water pressure to the home determines the flow from the dispenser.
- **Is there a water filter installed on the refrigerator?** The filter may be clogged or incorrectly installed.
- **Is a reverse osmosis water filtration system connected to your cold water supply?** See “Water Supply Requirements.”

Water is leaking from the dispenser

Check the following:

- Is the glass not being held under the dispenser long enough?
- Has the water system been flushed since installation or changing filters?

The dispenser water is not cool enough

NOTE: Water from the dispenser is chilled to only 50°F (10°C).

- **Has the refrigerator been newly installed or a large amount of water recently dispensed?** Allow 24 hours for the refrigerator to cool completely.
- **Has water not been recently dispensed?** The first glass of water may not be cool. Discard the first glass of water.

ACCESSORIES

To order accessories, contact the dealer from whom you purchased your refrigerator and ask for the appropriate part number listed below.

Stainless Steel Cleaner and Polish:

Part #4396095

Replacement Filters:

Do not use with water that is microbiologically unsafe or of unknown quality without adequate disinfection before or after the system. Systems certified for cyst reduction may be used on disinfected waters that may contain filterable cysts.

Interior Water Filter:

Part #W10291030 (P4RFWB)

Air Filter:

Part #W10311524

ASSISTANCE OR SERVICE

Before calling for assistance or service, please check "Troubleshooting." It may save you the cost of a service call.

If you still need help, contact the dealer from whom you purchased the refrigerator.

If you need replacement parts

Look for quality replacement parts whenever you need a replacement part for your refrigerator.

To locate factory specified replacement parts in your area, contact the dealer from whom you purchased your refrigerator.

Warranty

Contact the dealer from whom you purchased the refrigerator for warranty information.

Keep this book and your sales slip together for future reference. You must provide proof of purchase or installation date for in-warranty service.

Write down the following information about your appliance to help you obtain assistance or service if you ever need it. You will need to know your complete model number and serial number. You can find this information on the model and serial number label, located on the inside wall of the refrigerator compartment.

Dealer name _____

Serial number _____

Address _____

Phone number _____

Model number _____

Purchase date _____

IKEA GUARANTEE

How long is the IKEA guarantee valid?

This guarantee is valid for five (5) years from the original date of purchase of your appliance at IKEA, unless the appliance is named LAGAN in which case two (2) years of guarantee apply. The original sales receipt, is required as proof of purchase. If service work is carried out under guarantee, this will not extend the guarantee period for the appliance.

Which appliances are not covered by the IKEA five (5) years guarantee?

The range of appliances named LAGAN .

Who will execute the service?

IKEA has appointed Whirlpool (Australia) Pty Ltd as the authorised service network partner.

- If you encounter any trouble with the appliance and wish to register a call with Whirlpool, please call:

**Australia contact centre:
1300 363 344.**

What does this guarantee cover?

The guarantee covers applicable faults of the appliance, as per the terms and conditions, from the date of purchase from IKEA. This guarantee applies to domestic use only. The exceptions are specified under the headline "What is not covered under this guarantee?" Within the guarantee period, the costs to remedy the fault e.g. repairs, parts, labour and travel will be covered, provided that the appliance is accessible for repair without special expenditure. Replaced parts become the property of IKEA.

The services will be in-home service for domestic appliances, and must to be done by official Whirlpool service network. Goods presented for repair may be replaced by refurbished goods of the same type rather than being repaired.

Refurbished parts may be used to repair the goods.

If the authorized service agent requests you to deliver the product directly to them, please ensure that the appliance is suitably packaged to prevent any damage during transportation.

What will IKEA do to correct the problem?

IKEA appointed service provider will examine the product and decide, at its sole discretion, if it is covered under this guarantee. If considered covered, IKEA service provider or its authorized service partner through its own service operations, will then, at its sole discretion, either repair the defective product or replace it with the same or a comparable product.

What is not covered under this guarantee?

- Normal wear and tear.
- Deliberate or negligent damage, damage caused by failure to observe operating and maintenance instructions, incorrect installation or by connection to the wrong voltage, damage caused by chemical or electrochemical reaction, rust, abrasion or scratching, corrosion or water damage including but not limited to damage caused by excessive lime in the water supply, damage caused by abnormal environmental conditions.
- Damage caused from the use of the appliance in a manner other

than the use for which it was specifically designed.

- Damage caused by power outages, electrical power surge or improper supply voltage via connection to Supply Authority mains or alternative supply systems.
- Consumable parts including batteries and lamps, removable wire, glass and plastic trays and other accessories.
- Internal or external damage as a result of excessive use of cleaning products or cleaning agents.
- Non-functional and decorative parts which do not affect normal use of the appliance, including any scratches and possible color differences.
- Accidental damage or blockages caused by foreign objects, eg. coins, underwires, nails, buttons or jewellery, or substances and cleaning or unblocking of filters, drainage systems or soap drawers
- Damage caused by vermin, insects or pets.
- Note – internal or external cabinet transport damage must be reported within 7 days of purchase date.
- Damage to the following parts: ceramic glass, accessories, crockery and cutlery baskets, feed and drainage pipes, seals, lamps and lamp covers, screens, knobs, casings and parts of casings. Unless such damages can be proved to have been caused by production faults.
- Cases where no fault could be found during a technician's visit.
- Any consequential loss due to appliance failure.
- Repairs not carried out by our appointed service providers and/or an authorized service contractual partner or where non original parts have been used.
- Repairs to parts or systems caused by unauthorized modifications made to appliance.
- Repairs caused by installation which is faulty or not according to specification.
- Problems caused by incorrect or inadequate venting of the appliance.
- The use of the appliance in a non domestic environment i.e. professional use.
- Transportation damages. If a customer transports the product to his home or another address, IKEA is not liable for any damage that may occur during transport. However, if IKEA delivers the product to the customer's delivery address, then damage to the product that occurs during this delivery will be covered by IKEA.
- Cost for carrying out the initial installation of the IKEA appliance. However, if an IKEA appointed service provider or its authorized service partner repairs or replaces the appliance under the terms of this guarantee, the appointed service provider or its authorized service partner will reinstall the repaired appliance or install the replacement, if necessary.
- The benefits conferred by this express warranty are in addition to all other conditions, warranties, guarantees, rights and remedies expressed or implied by the Trade Practices Act and similar State and Territory laws and all other obligations and liabilities on the part of the manufacturer or supplier and nothing contained herein shall restrict or modify such rights, remedies, obligations or liabilities

ENGLISH

How country law applies?

Our goods come with guarantees that cannot be excluded under the Australian Consumer Law.

You are entitled to a replacement or refund for a major failure and for compensation for any other reasonably foreseeable loss or damage.

You are also entitled to have the goods repaired or replaced if the goods fail to be of acceptable quality and the failure does not amount to a major failure.

Area of validity

The IKEA guarantee applies only to products purchased and installed in AUSTRALIA.

The dedicated AFTER SALES for IKEA appliances

Please don't hesitate to contact IKEA appointed After Sales Service Provider to:

- make a service request under this guarantee;
- ask for clarifications on installation of the IKEA appliance in the dedicated IKEA kitchen furniture;
- ask for clarification on functions of IKEA appliances.
- Call our authorized service network partner Whirlpool on **1300 363 344 (Australia)**.

WARRANTY PROCEDURE

Please ensure that installation procedure entailed in the user manual has been adhered to and in case of any doubts please refer to the trouble shooting guide that has been supplied with the appliance.

- Please read the user guide to ensure that you are aware of all the features & benefits of the appliance.

How to reach if you need our service The Whirlpool call centre team will assist you on the phone with basic trouble shooting for your appliance at the time of warranty call registration.

Please describe the problem that you are facing with the appliance in detail along with your product model number, serial number, date of purchase at the time of call registration.

Please also always refer to the IKEA article number (8 digit code) and 12 digit service number placed on the rating plate of your appliance.

How to reach if you need our service The Whirlpool call centre team will assist you on the phone with basic trouble shooting for your appliance at the time of warranty call registration.



1300 363 344

Please describe the problem that you are facing with the appliance in detail along with your product model number, serial number, date of purchase at the time of call registration.

Please also always refer to the IKEA article number (8 digit code) and 12 digit service number placed on the rating plate of your appliance.



SAVE THE SALES RECEIPT!

Kindly keep all these details and original invoice of purchase handy during the service technician's visit to enable him to carry out the job.



Whirlpool reserves the right not to register the call under warranty if you fail to provide these details at the time of call registration.

Do you need extra help?

For any additional questions not related to After Sales of your appliances please contact your nearest IKEA store call centre. We recommend you read the appliance documentation carefully before contacting us.

For details on service agents locations, please visit – www.whirlpool.com.au/services.

