

FRIGIDAIRE

All about the

Use & Care

of your Cooktop

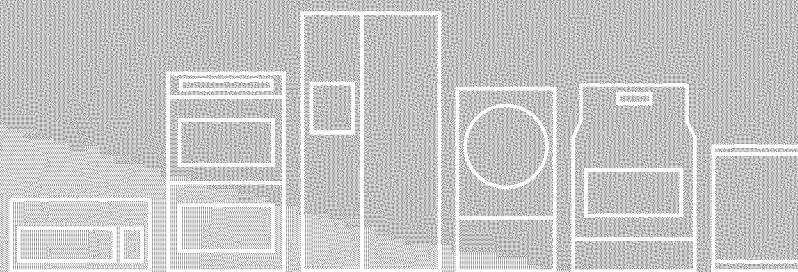

TABLE OF CONTENTS

Welcome & Congratulations	2	Setting Induction Surface Controls.....	10
Important Safety Instructions.....	3	Induction Surface Cooking	11
Cooktop Features	5	Care & Cleaning	13
Before Setting Surface Controls	6	Before You Call	15
Setting Surface Controls	7	Major Appliance Warranty	16
Setting Radiant Surface Controls	8		

WELCOME & CONGRATULATIONS

Product Registration

Register Your Product

The **PRODUCT REGISTRATION CARD** should be filled in completely, signed and returned to Electrolux Home Products.

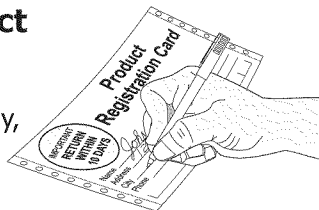

Congratulations on your purchase of a new appliance! At **Electrolux Home Products**, we are very proud of our product and are completely committed to providing you with the best service possible. Your satisfaction is our number one priority.

We know you'll enjoy your new appliance and **Thank You** for choosing our product. We hope you consider us for future purchases.

PLEASE CAREFULLY READ AND SAVE THESE INSTRUCTIONS

This Use & Care Manual contains general operating instructions for your appliance and feature information for several models. Your product **may not** have all the described features. The graphics shown are representative. The graphics on your appliance may not look exactly like those shown. These instructions are not meant to cover every possible condition and situation that may occur. Common sense and caution must be practiced when installing, operating and maintaining any appliance.

Serial Plate Location

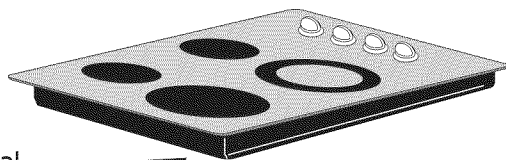

Cooktop Serial Plate Location

Please record your model and serial numbers below for future reference.

Model Number: _____

Serial Number: _____

Purchase Date: _____

NOTE

Please attach sales receipt here for future reference.

IMPORTANT SAFETY INSTRUCTIONS

**Read all instructions before using this appliance.
Save these instructions for future reference.**

DEFINITIONS

 This is the safety alert symbol. It is used to alert you to potential personal injury hazards. Obey all safety messages that follow this symbol to avoid possible injury or death.

WARNING

This symbol will help alert you to situations that may cause serious bodily harm, death or property damage.

CAUTION

This symbol will help alert you to situations that may cause bodily injury or property damage.

IMPORTANT

IMPORTANT indicates installation, operation or maintenance information which is important but not hazard-related.

WARNING

To reduce the risk of fire, electrical shock, or injury when using your electric cooktop, follow basic precaution including the following:

This unit has been tested and found to comply with the limits for a class B digital device, pursuant to Part 18 of the FCC rules. These limits are designed to provide reasonable protection against harmful interference in a residential installation. This unit generates, uses and can radiate radio frequency energy and, if not installed and used in accordance with the instructions, may cause harmful interference to radio communications. However there is no guarantee that interference will not occur in a particular installation. If this unit does cause harmful interference to radio or television reception, which can be determined by turning the unit off and on, the user is encouraged to try to correct the interference by one or more of the following measures:

- Reorient or relocate the receiving antennae.
- Increase the distance between the unit and receiver.
- Connect the unit into an outlet or a circuit different from that to which the receiver is connected.
- **Remove all tape and packaging wrap before using the appliance. Destroy the carton and plastic bags after unpacking the appliance.** Never allow children to play with packaging material.

- **Proper Installation. Be sure your appliance is properly installed and grounded by a qualified technician in accordance with the National Electrical Code No. 70 - latest edition in the United States, or CSA C22.1, Part 1 in Canada, and local code requirements.** Install only per installation instructions provided in the literature package for this appliance.

Ask your dealer to recommend a qualified technician and an authorized repair service. Know how to disconnect the electrical power to the appliance at the circuit breaker or fuse box in case of an emergency.

- **User Servicing. Do not repair or replace any part of the appliance unless specifically recommended in the manuals.** All other servicing should be done only by a qualified technician to reduce the risk of personal injury and damage to the appliance.
- **Never modify or alter the construction of an appliance such as removal of panels, wire covers or any other permanent part of the appliance.**
- **Storage on Appliance. Flammable materials should not be stored near surface units.** This includes paper, plastic and cloth items, such as cookbooks, plasticware and towels, as well as flammable liquids. Do not store explosives, such as aerosol cans, on or near the appliance. Flammable materials may explode and result in fire or property damage.

CAUTION

Do not store items of interest to children in the cabinets above the appliance. Children climbing on the cooktop to reach items could be seriously injured.

- **Do not leave children alone. Children should not be left alone or unattended in the area where an appliance is in use.** They should never be allowed to sit or stand on any part of the appliance.

WARNING

Stepping or leaning on this cooktop can result in serious injuries and may also cause damage to the cooktop. Do not allow children to climb or play around the cooktop.

- **DO NOT TOUCH SURFACE UNITS OR AREAS NEAR THESE UNITS.** Surface units may be hot even though they are dark in color. Areas near surface units may become hot enough to cause burns. During and after use, do not touch, or let clothing or other flammable materials touch these areas until they have had sufficient time to cool. Among these areas are the cooktop and areas facing the cooktop.

IMPORTANT SAFETY INSTRUCTIONS

WARNING

Never use your appliance for warming or heating the room.

- **Wear Proper Apparel.** Loose-fitting or hanging garments should never be worn while using the appliance. Do not let clothing or other flammable materials contact hot surfaces.
- **Do Not Use Water or Flour on Grease Fires.** Smother the fire with a pan lid, or use baking soda, a dry chemical or foam-type extinguisher.
- **When heating fat or grease, watch it closely.** Fat or grease may catch fire if allowed to become too hot.
- **Use Only Dry Pot holders.** Moist or damp pot holders on hot surfaces may result in burns from steam. Do not let the pot holders touch hot surface units. Do not use a towel or other bulky cloth instead of a pot holder.
- **Do Not Heat Unopened Food Containers.** Buildup of pressure may cause the container to burst and result in injury.

IMPORTANT

Do not attempt to operate the cooktop during a power failure. If the power fails, always turn off the cooktop. If the cooktop is not turned off and the power resumes, the cooktop will not operate and an error message will be displayed.

IMPORTANT SAFETY INSTRUCTIONS FOR USING YOUR COOKTOP

- **Know which knob controls each surface unit.**
- **Clean the appliance regularly to keep all parts free of grease that could catch fire.** Exhaust fan ventilation hoods and grease filters should be kept clean. Do not allow grease to accumulate on hood or filter. Greasy deposits in the fan could catch fire. When flaming food under the hood, turn fan on. Refer to hood manufacturer's instructions for cleaning.
- **Use Proper Pan Size.** This appliance is equipped with one or more surface units of different sizes. Select utensils having flat bottoms large enough to cover the surface unit. The use of undersized utensils will expose a portion of the surface heating unit to direct contact and may result in ignition of clothing. Proper relationship of utensil to element will also improve efficiency.
- **Utensil Handles Should Be Turned Inward and Not Extend Over Adjacent Surface Units.** To reduce the risk of burns, ignition of flammable materials, and spillage due to unintentional contact with the utensil.

- **Never Leave Surface Units Unattended.** Boilovers cause smoking and greasy spillovers that may ignite, or a pan that has boiled dry may melt.
- **Protective Liners.** Do not use aluminum foil to line any part of the appliance. Only use aluminum foil as recommended for baking if used as a cover placed on the food. Any other use of protective liners or aluminum foil may result in a risk of electric shock or fire or short circuit.
- **Glazed Cooking Utensils.** Only certain types of glass, glass/ceramic, ceramic, earthenware, or other glazed utensils are suitable for range top service without breaking due to the sudden change in temperature. Check the manufacturer's recommendations for cooktop use.
- **Ventilating hood.** The ventilating hood above your cooking surface should be cleaned frequently, so the grease from cooking vapors does not accumulate on the hood or filter.
- **Do Not Use Decorative Surface Element Covers.** If an element is accidentally turned on, the decorative cover will become hot and possibly melt. Burns will occur if the hot covers are touched. Damage may also be done to the appliance.
- **Do Not Clean or Operate a Broken Cooktop.** If cooktop should break, cleaning solutions and spillovers may penetrate the broken cooktop and create a risk of electric shock. Contact a qualified technician immediately.
- **Clean Cooktop with Caution.** If a wet sponge or cloth is used to wipe spills on a hot cooking area, be careful to avoid a steam burn. Some cleaners can produce harmful fumes if applied to a hot surface.
- **Do Not Place Hot Cookware on Cold Cooktop Glass.** This could cause glass to break.
- **Do not slide pan across the cooktop surface.** They may scratch the cooktop surface.
- **Do Not Let Pans Boil Dry.** This may cause permanent damage in the form of breakage, fusion, or marking that can affect the ceramic-glass cooktop. (This type of damage is not covered by your warranty).

IMPORTANT SAFETY NOTICE

The California Safe Drinking Water and Toxic Enforcement Act requires the Governor of California to publish a list of substances known to the state to cause cancer, birth defects or other reproductive harm, and requires businesses to warn customers of potential exposure to such substances.

Read these instructions carefully before using the cooktop

INDUCTION ELEMENT CHARACTERISTICS (RIGHT FRONT AND REAR ELEMENTS)

A COOLER COOKTOP- A unique feature of the Induction Cooktop is whether turned ON or OFF, the cooktop surface remains cooler than standard ceramic cooktops.

MAGNETIC DETECTOR- The coil sensor automatically detects whether the pan is magnetic and eliminates accidental "turn-On."

PAN SIZE DETECTION- The pan recognition sensor automatically detects and adapts the Cooking Zones to the pan sizes in use.

EFFICIENT- Induction cooking heats faster while using less energy. Induction power levels are quick to boil and when simmering.

CAUTION

The Cooking Zones may appear to be cool while turned ON and after they have been turned OFF. **The glass surface may be HOT from residual heat transferred from the cookware and burns may occur.**

1. Left Rear Single Radiant Element
2. Bridge Radiant Element
3. Left Front Radiant Element
4. Right Front Induction Element
5. Right Rear Induction Element
6. Center Rear Single Radiant Element (Fig. 2 only)
7. Right Rear Element Control Knob
8. Left Rear Element Control Knob
9. Left Front Element Control Knob
10. Right Front Element Control Knob
11. Center Rear Element Control Knob (Fig. 2 only)
12. Rear Pilot Light (Element On)
13. Front Pilot Light (Element On)

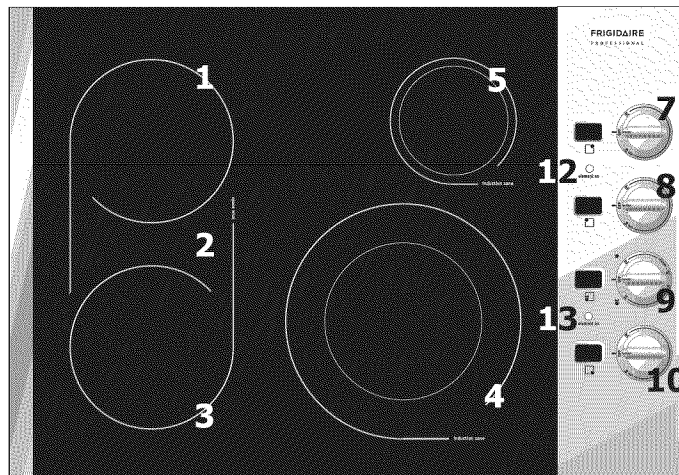

Figure 1 - 30" Model

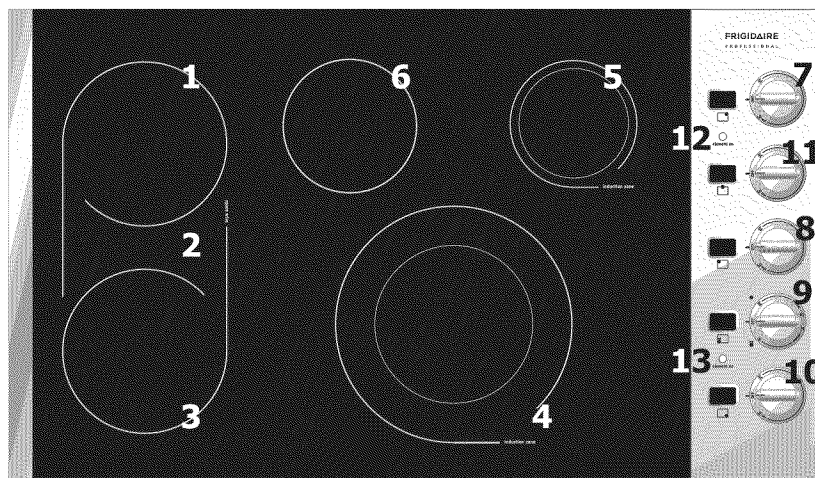

Figure 2 - 36" Model

BEFORE SETTING SURFACE CONTROLS

About the Ceramic Glass Cooktop

The ceramic cooktop has inductors and radiant surface elements located below the surface of the glass. The design of the ceramic cooktop outlines the area of the surface element underneath. **Make sure** the diameter of the pan matches the diameter of the element outline on the cooktop (See Figs. 1 to 4).

Only flat-bottom cookware should be used. The type and size of cookware, the number of surface elements in use and their settings are all factors that will affect the amount of heat that will spread to areas beyond the surface elements. The areas surrounding the elements may become **hot enough to cause burns**.

NOTE

Please read detailed instructions for ceramic glass cooktop cleaning in the **General Care & Cleaning** section and **Before You Call** checklist section of this Use and Care Guide.

About the Radiant Surface Elements

The element temperature rises gradually and evenly. As the temperature rises, the element will glow red. To maintain the selected setting, the element will cycle ON and OFF. The heating element retains enough heat to provide a uniform and consistent heat during the OFF cycle. For efficient cooking, turn OFF the element several minutes before cooking is complete. This will allow residual heat to complete the cooking process.

Locations of the Surface Radiant & Induction Elements

Your cooktop is equipped with radiant surface radiant elements with different wattage ratings. The ability to heat food quicker and in larger volumes increases as the element wattage increases.

The surface elements are located on the 30" cooktop as follows (Figure 1):

- Two 7 inch radiant elements are located at the left front and rear positions.
- One mid-position radiant element located between left front and rear element. Connects with front element to form **Bridge** element.
- One 6 inch induction element located at the right rear position.
- One 10 inch induction element located at the right front position.

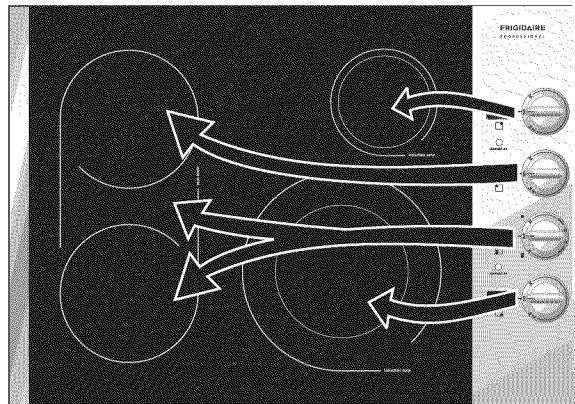

Figure 1 - 30" Model

The surface elements are located on the 36" cooktop as follows (Figure 2):

- Two 7 inch radiant elements are located at the left front and rear positions.
- One mid-position radiant element located between left front and rear element. Connects with front element to form **Bridge** element.
- One 6 inch radiant element located at the center rear position.
- One 6 inch induction element located at the right rear position.
- One 10 inch induction element located at the right front position.

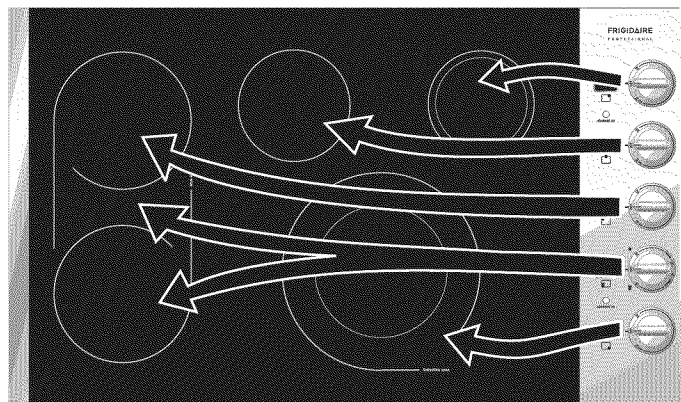

Figure 2 - 36" Model

SETTING SURFACE CONTROLS

The Electronic Surface Element Control (ESEC)

The Electronic Surface Element Control ("ESEC") includes digital display windows. The ESEC provides a numeric digital setting for the surface element positions on the cooktop. These settings work the same way as normal knob setting indicators work except the settings are displayed in digital windows (Figs. 1 thru 8).

The available ESEC Display Settings

The ESEC control provides various heat levels from **Hi** (Fig. 2) to **Lo** (Fig. 4) and OFF (Fig. 1). The settings between **9.5** and **3.0** decrease or increase in increments of .5 (1/2). The settings between **3.0** and **1.2** are Simmer settings which decrease or increase in increments of .2 (1/5) to **Lo** (Figure 4; lowest Simmer setting) for more precise settings at lower heat levels. Use the Recommended Surface Setting Chart to determine the correct setting for the kind of food you are preparing.

Power Failure Indicator Message (PF)

When the range is first plugged in or when the power supply to the range has been interrupted, the ESEC control will display the message "**PF**" (Power Failure; See Fig. 7). After a few seconds the "**PF**" message will disappear from the display.

Hot Element Indicator Message (HE)

After using any of the element positions the cooktop will become very hot. Even after turning the control knob to OFF, the cooktop will remain hot for some time. The ESEC control monitors the temperature of the cooktop and displays the message "**HE**" (hot element) warning when the cooktop is still too hot to touch (See Fig. 5). If the **HE** message appears in the window, the control can still be turned ON again for use.

Error Indicator Message (Er)

An error message will be displayed (glowing "Er") at power up (or after a power failure) if ANY of the surface control knobs were left in the ON positions (See Fig. 8). If a power failure should occur, be sure to set all of the surface control knobs to the OFF position. This will reset the surface controls.

The induction zones are equipped with a pot detection system. If the controls are activated and the detection system cannot find any pot on the zone, it will flash its power level for 3 minutes. After flashing for 3 minutes, the digital display will show an "**Er**" message.

Once the surface controls have been set to the OFF positions, the surface controls should return to normal operation. If the surface controls do not function and the "**Er**" message remains in any display after following these procedures, contact your authorized servicer for assistance.

Power Boost Indicator Message (Pb)

When an induction zone is first set at Hi, the Power Boost feature will turn on (see Fig. 6). The Power Boost feature is used to bring large quantities of water or food to cooking temperature at the fastest speed possible. The Power Boost feature will give you up to 139% power output for a set amount of time (approx. 10 min).

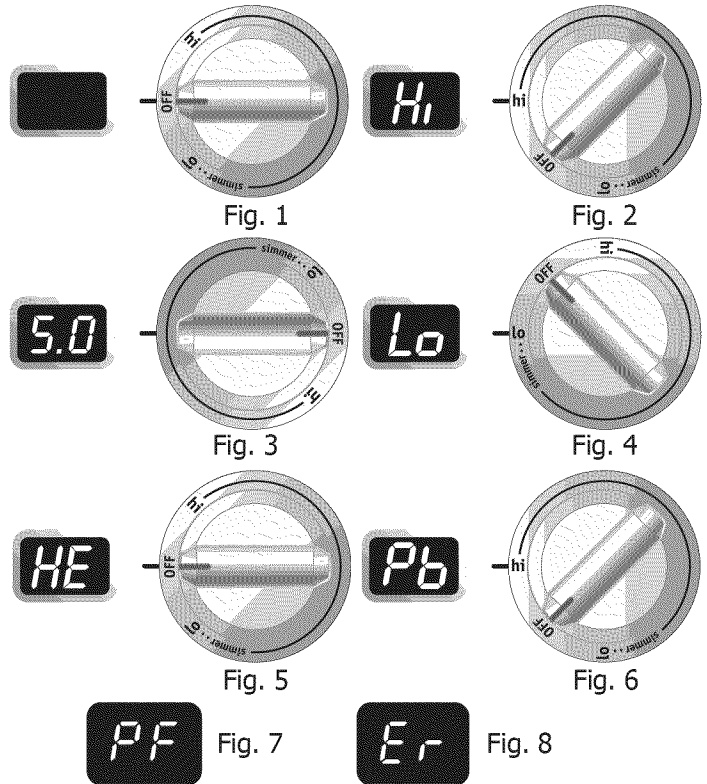

Control knobs shown are typical only.

Surface cooking settings

Use the chart to determine the correct setting for the type of food you are preparing.

Note: The size and type of cookware used will influence the setting needed for best cooking results.

Recommended Setting for Surface Element	
Setting	Type of Cooking
HIGH (HI)	Start most foods; bring water to a boil and pan broiling.
MEDIUM HIGH (8-10)	Continue a rapid boil; frying, deep fat frying.
MEDIUM (6)	Maintain a slow boil; thicken sauces and gravies; steaming vegetables.
MEDIUM LOW (2 - 4)	Keep foods cooking; poaching and stewing.
LOW (LO)	Keep warm, melting and simmering.

NOTE

Radiant elements have a limiter that allows the element to cycle on and off, even at the HI setting. This helps to prevent damage to the ceramic smooth top. Cycling at the HI setting is normal and can occur if the cookware is too small for the radiant element or if the cookware bottom is not flat.

SETTING RADIANT SURFACE CONTROLS

Operating the Single Surface Radiant Elements

The cooktop has 1 or 2 SINGLE radiant surface elements: the LEFT REAR position and the center rear position (on the 36" model only). The left rear element may also be used with the Bridge element (Figures 1 and 2).

To Operate the Single Radiant Surface Elements

1. Place correctly sized cookware on the radiant surface element.
2. Push in and turn the surface control knob in either direction to the desired setting (Figure 3).
3. Turn the knob to adjust the setting if desired. Start most cooking operations on a higher setting and then turn to a lower setting to finish cooking. Each surface element provides a constant amount of heat at each setting. A glowing red surface heating area extending beyond the bottom edge of the cookware indicates the cookware is **too small** for the surface heating area.
4. When cooking has completed, turn the surface control knob to **OFF** before removing the cookware.

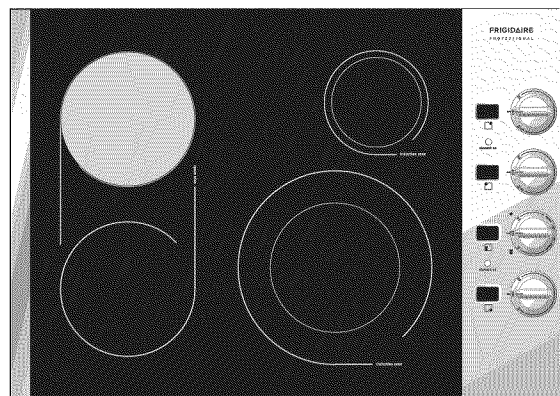

Figure 1

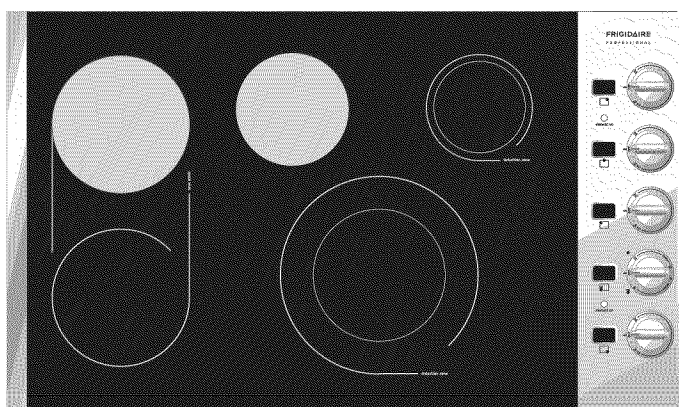

Figure 2

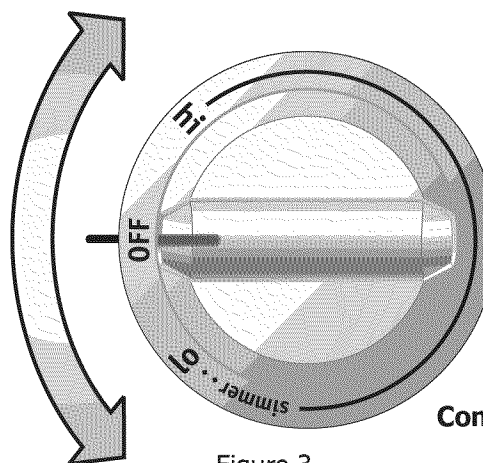

Figure 3

Control knob shown is typical only.

NOTE

The surface "Element On" indicator lights will glow when one or more elements are turned on. A quick glance at these indicator lights when cooking is finished is an easy check to be sure all surface elements are turned off.

NOTE

See Recommended Setting for Surface Element table on page 7.

CAUTION

Do not place plastic items such as salt and pepper shakers, spoon holders or plastic wrappings on cooktop when it is in use. These items could melt or ignite. Potholders, towels or wooden spoons could catch fire if placed too close to the surface elements.

CAUTION

Do not allow aluminum foil, or ANY material that can melt to make contact with the ceramic glass cooktop. If these items melt on the cooktop they will damage the ceramic cooktop.

CAUTION

Radiant surface elements may appear to have cooled after they have been turned OFF. **HE** (Hot Element) message will turn ON and will continue to glow until the glass cooktop has cooled down to a moderate level. **The glass surface may still be hot** and burns may occur if the glass surface is touched before the indicator light has turned OFF. The message may remain on even though the controls are turned OFF.

SETTING RADIANT SURFACE CONTROLS

Operating the Bridge Surface Radiant Element

The cooktop is equipped with a "BRIDGE" surface element located at the left front and middle (See Figures 1 & 2) positions. The Bridge can be used when cooking with rectangular (like a griddle) or oval shaped cookware. The element will maintain an even temperature setting across both portions of the Bridge. If needed for normal cookware, the Bridge element can work like a single element without the Bridge (See Figure 5). The ● symbol indicates that only the front portion will heat (Fig. 3). The ◐ symbol indicates that both front and middle portions will heat (Fig. 4). You may switch from either coil setting at any time during cooking.

To Operate the Bridge Surface Element:

1. Place correctly sized cookware on the Bridge surface element.
2. Push in and turn the control knob as shown in Figure 3 to heat the front portion of the Bridge element for normal shaped cookware or in Figure 4 for larger or rectangular shaped cookware.
3. Turn the knob to adjust the setting if needed. Start most cooking operations on a higher setting and then turn to a lower setting to finish cooking. Each surface element provides a constant amount of heat at each setting. A glowing red surface heating area extending beyond the bottom edge of the cookware indicates the cookware is **too small**. Please note that not all cookware will fit the Bridge element correctly.
4. When cooking has completed, turn the surface control knob to **OFF** before removing the cookware.

The BRIDGE element may also be used in combination with the left rear single element (See Figure 7). Because these elements have 2 different controls, one element can be used to cook while the other element may be used to keep food warm.

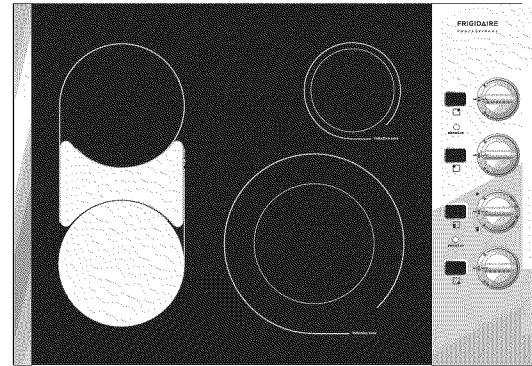

Figure 1

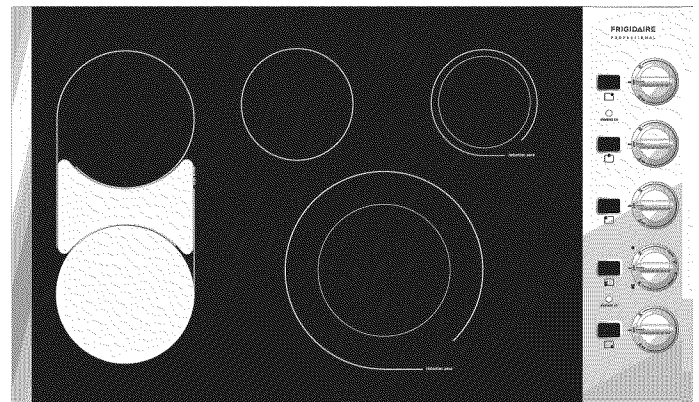

Figure 2

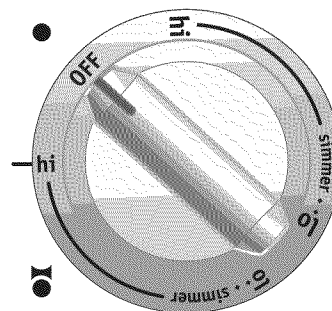

Figure 3

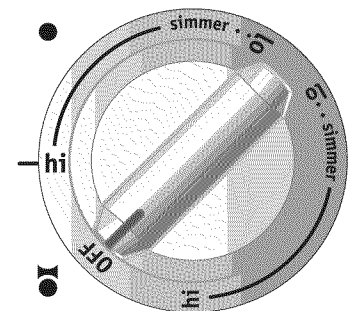

Figure 4

NOTE

The surface "Element On" indicator lights will glow when one or more elements are turned on. A quick glance at these indicator lights when cooking is finished is an easy check to be sure all surface elements are turned off.

NOTE

See Recommended Setting for Surface Element table on page 7.

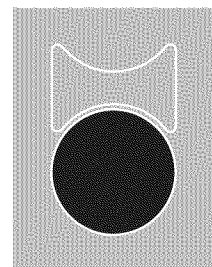

Figure 5
Front portion
only

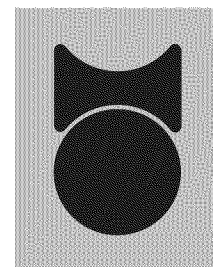

Figure 6
Front & Middle
portions

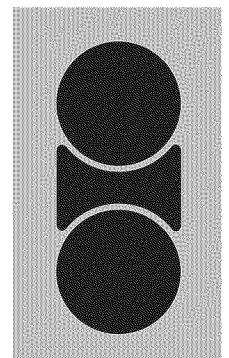

Figure 7
Front & Middle
plus Left Rear

SETTING INDUCTION SURFACE CONTROLS

Operating the Induction Surface Elements

The cooktop is equipped with 2 induction surface elements: the RIGHT FRONT and REAR positions (Figure 1 and 2).

To Operate the Induction Surface Elements

1. Place the correctly sized cookware of the proper material on the induction surface element.
2. Push in and turn the surface control knob in either direction to the desired setting (Figure 3).

Note: Turning the knob to Hi from Off will activate the Power Boost feature. The Power Boost feature is used to bring large quantities of water or food to cooking temperature at the fastest speed possible. The Power Boost feature will give you up to 139% power output for a set amount of time (approx. 10 min).

3. Turn the knob to adjust the setting if desired. Start most cooking operations on a higher setting and then turn to a lower setting to finish cooking. Each surface element provides a constant amount of heat at each setting.
4. When cooking has completed, turn the surface control knob to **OFF** before removing the cookware.

Power Sharing

Your cooktop is equipped with two induction elements within one heating section. The Cooking Zones are powered by an independent induction inverter. The two Cooking Zones in the heating section share the power of the inverter. This is called Power Sharing.

For example, if pans are cooking food items on both Cooking Zones, the last Power Level set will be maintained, while the first pan may experience a slight reduction in the power level setting. The element ON indicator light will turn GREEN when power sharing is enabled.

POWER SHARING TIPS: Remember to set the power level for the food item you wish to maintain last (See Fig. 4).

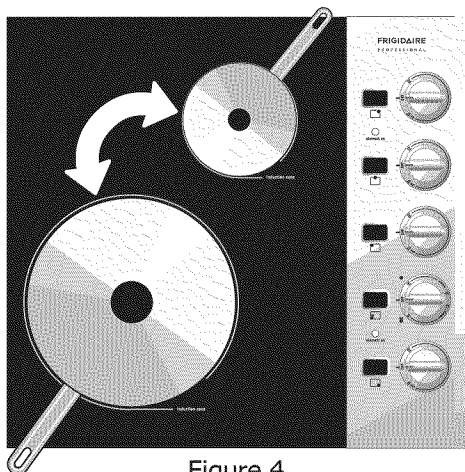

Figure 4

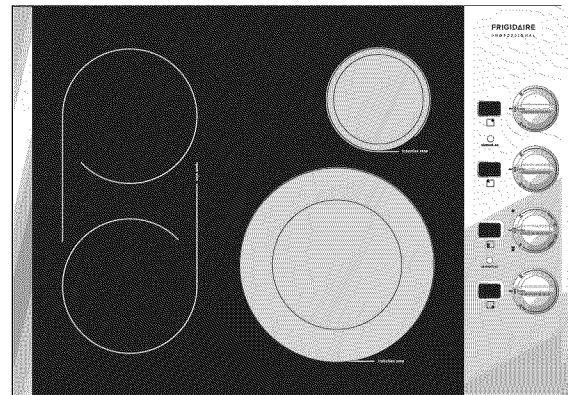

Figure 1

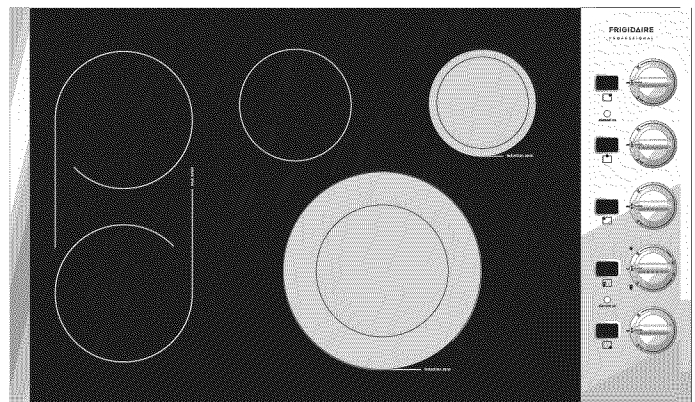

Figure 2

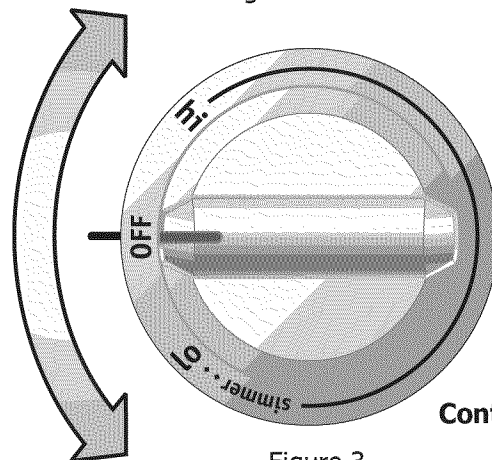

Figure 3

Control knob shown is typical only.

CAUTION

The glass cooktop may appear to have cooled after the elements have been turned OFF. The induction elements do not heat directly the cooktop but heat will be transferred from the cookware to the glass cooktop. **HE** (Hot Element) message will turn ON and will continue to glow until the glass cooktop has cooled down to a moderate level. **The glass surface may still be hot** and burns may occur if the glass surface is touched before the indicator light has turned **OFF**. The message may remain on even though the controls are turned **OFF**.

INDUCTION SURFACE COOKING

Use the Correct Cookware Type

For the induction zones, the magnetic Cooking Zone sensors located below the cooktop surface require the use of cookware made with magnetic material in order to start the heating process on any of the Cooking Zones.

When purchasing pans, look for cookware specifically identified by the manufacturer for use with Induction cooktops. If you are not sure, use a magnet to test whether the cookware type will work. If a magnet sticks to the bottom of the cookware, the material type is correct for Induction cooking (See Fig. 1).

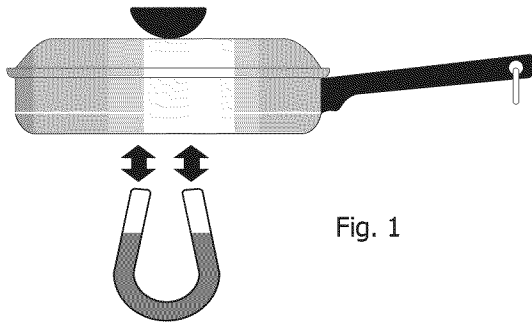

Fig. 1

It is recommended to always use heavier high quality stainless steel cookware on your Induction Cooktop surface. This will greatly reduce the possibility of developing scratches on the ceramic surface.

Even quality cookware can scratch the cooktop surface, especially if cookware is slid over the ceramic cooktop surface without being lifted up. Over time sliding **ANY** type of cookware over the ceramic cooktop will likely alter the overall appearance of the cooktop. Eventually the buildup of scratches will make cleaning the surface difficult and degrade the overall appearance of the cooktop.

Operational Noise

The electronic processes involved with Induction Cooking create some unusual background noises. These noises are normal and part of the Induction Cooking process.

Please note that these noises are more noticeable while cooking at the Power BOOST level. Very loud noises are not part of normal Induction Cooking.

Use the Correct Cookware Size

The Cooking Zones available on the Induction Cooktop require a MINIMUM pan size to be used at each location. The inner ring of each Cooking Zone is your guide to the correct MINIMUM pan size. The pan bottom must FULLY cover the inner ring for proper cooking to occur.

The thicker outer ring at each Cooking Zone is helpful to determine the pan MAXIMUM size. After centering the cookware on the cooktop, make sure the cookware does not extend more than 1/2" beyond the thicker line on the Cooking Zone. The pan must make FULL contact on the glass surface without the bottom of the pan touching the metal cooktop trims.

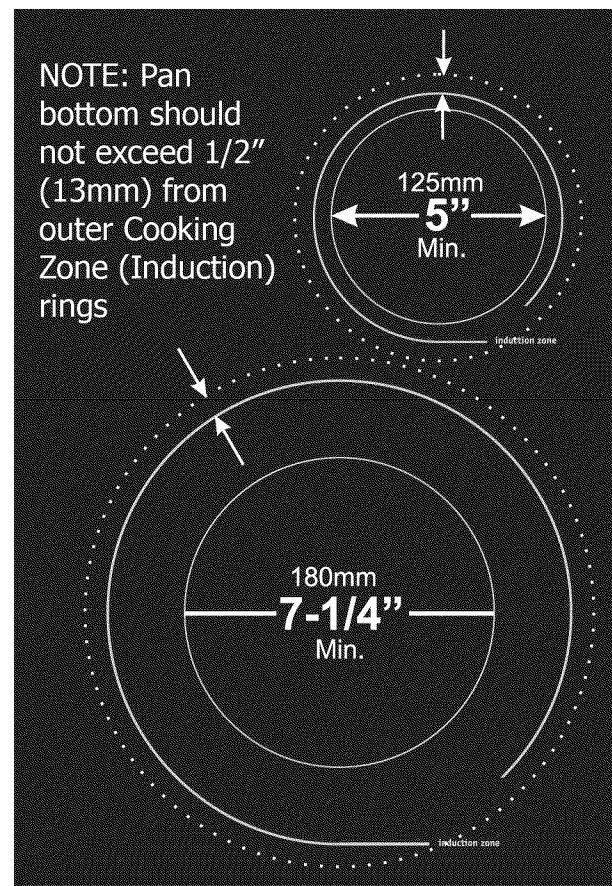

NOTE

If a pan made of the correct material is centered properly on any of the active Cooking Zones but is TOO SMALL, the power level will flash in the in the digital display and the pan will not heat. After 3 minutes, an "Er" error code will be displayed until the controls are set to **OFF**.

INDUCTION SURFACE COOKING

Cookware Recommendations

Be sure to follow the following recommendations for using cookware as shown:

INCORRECT

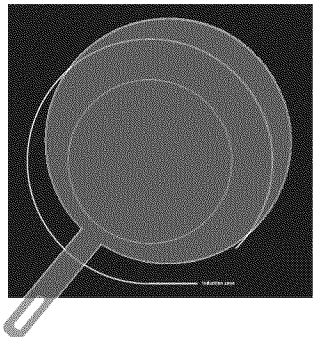

- Cookware not centered on Cooking Zone surface.

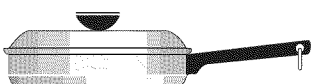

- Curved or warped pan bottoms or sides.

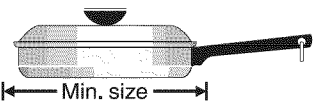

- Pan does not meet the minimum size required for the Cooking Zone used.

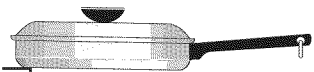

- Pan bottom rests on cooktop trim or does not rest completely on the cooktop surface.



- Heavy handle tilts pan.

CORRECT

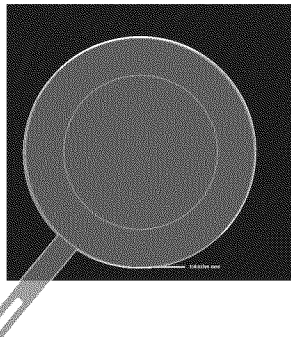

- Cookware centered correctly on Cooking Zone surface.

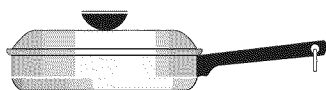

- Flat pan bottom & straight sides.

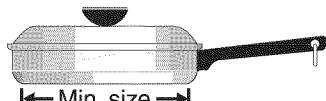

- Pan size meets or exceeds the recommended minimum size for the Cooking Zone.

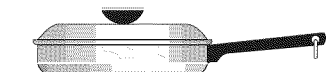

- Pan rests completely on the Cooktop surface.

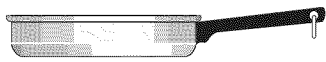

- Pan is properly balanced.

Fig. 1

NOTE

ANY one of the incorrect conditions listed above in Fig. 1 may be detected by the sensors located below the ceramic cooktop surface. If the cookware does not meet any of these conditions, one or more of the Cooking Zones will not heat indicated by a flashing power level in the digital display for that affected zone. Correct the problems before attempting to reactivate the cooktop.

Selecting Surface Cooking Cookware

The cookware used with the Induction Cooktop should have flat bottoms that make good contact with the entire surface of the Cooking Zone. Check for flatness by rotating a ruler across the bottom of the cookware (See Fig. 2). Be sure to follow all the recommendations for using cookware.

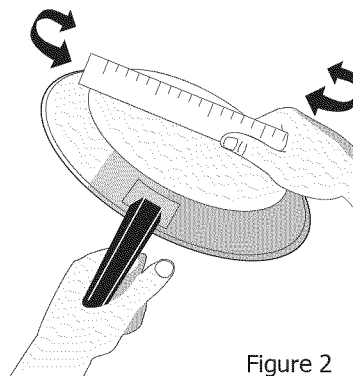

Figure 2

Also remember to:

- Use cookware made with the correct material type for Induction Cooking.
- Use quality cookware with heavier bottoms for better heat distribution allowing for more even cooking results.
- The pan size should match the amount of food being prepared.
- Do not let pans boil dry. This may cause permanent damage in the form of breakage, fusion, or marring that can affect the ceramic cooktop. (This type of damage is not covered by your warranty).
- Do not use dirty pans with grease buildup. Always use pans that are easy to clean after cooking.

CAUTION

- The Cooking Zones may appear to be cool while turned ON and after they have been turned OFF. The glass surface may be HOT from residual heat transferred from the cookware and burns may occur.
- DO NOT SLIDE Cookware across the cooktop surface. Doing so may permanently damage the appearance of the ceramic cooktop.
- DO NOT TOUCH HOT COOKWARE or PANS directly with hands. Always use oven mitts or pot holders to protect hands from burns.

Prior to using your cooktop for the first time, apply the recommended cooktop cleaning creme to the ceramic surface. Buff with a non-abrasive cloth or pad. This will make cleaning easier when soiled from cooking. The special cooktop cleaning cream leaves a protective finish on the glass to help prevent scratches and abrasions.

Cleaning Various Parts of Your Cooktop

Before cleaning any part of the cooktop, be sure all controls are turned OFF and the cooktop is COOL. REMOVE SPILLOVERS AND HEAVY SOILING AS SOON AS POSSIBLE. REGULAR CLEANINGS NOW WILL REDUCE THE DIFFICULTY AND EXTENT OF A MAJOR CLEANING LATER.

Surfaces	How to Clean
Stainless Steel Decorative Trim Cooktop, Control Knobs, Control Panel	Wipe the control panel clean after each use. Before cleaning the control panel, turn all controls to OFF and remove the control knobs. To remove, pull each knob straight off the shaft. Clean using hot, soapy water and a cloth. Do not use cleaners with high concentrations of chlorides or chlorines. Do not use harsh scrubbing cleaners. Be sure to squeeze excess water from the cloth before wiping the panel; especially when wiping around the controls. Excess water in or around the controls may cause damage to the appliance. Only use kitchen cleaners that are especially made for cleaning stainless steel. Always be sure to rinse the cleaners from the surface as bluish stains may occur during heating that cannot be removed. To replace knobs after cleaning, line up the flat sides of both the knob and the shaft; then push the knob into place.
Ceramic Glass Cooktop	See Ceramic Glass Cooktop in this Owner's Guide.

Ceramic Glass Cooktop Cleaning & Maintenance

Consistent and proper cleaning is essential to maintaining your Ceramic glass cooktop.

Prior to using your cooktop for the first time, apply the recommended CERAMA BRYTE® Cleaning Creme to the ceramic surface. Clean and buff with a non abrasive cloth or pad. This will make cleaning easier when soiled from cooking. The special cooktop cleaning cream leaves a protective finish on the glass to help prevent scratches and abrasions.

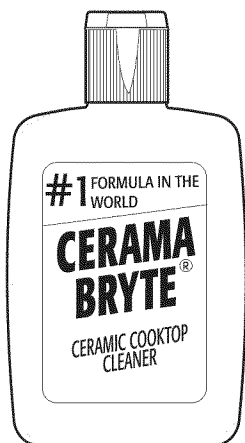

Sliding aluminum or copper clad bottom pans on the cooktop can cause metal markings on the cooktop surface. These marks should be removed **immediately** after the cooktop has cooled using the cooktop cleaning cream. Metal marks can become permanent if not removed prior to future use.

Cookware (cast iron, metal, ceramic or glass) with rough bottoms can mark or scratch the cooktop surface. **Do not slide anything metal or glass** across the cooktop. **Do not** use your cooktop as a cutting board or work surface in the kitchen. **Do not** cook foods directly on the cooktop surface without a pan. **Do not** drop heavy or hard objects on the glass cooktop, or they may crack it.

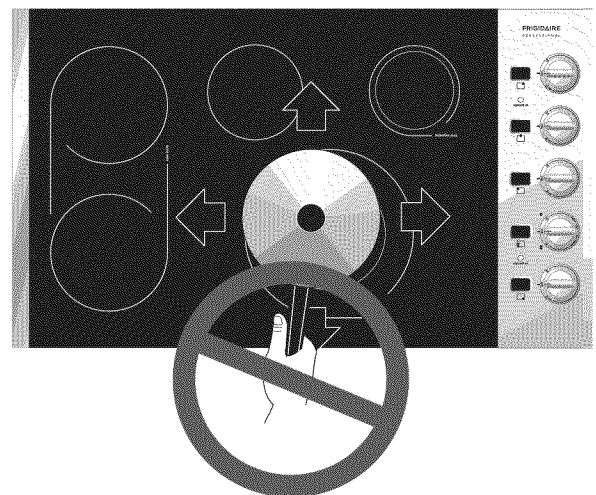

CARE & CLEANING

Cleaning Recommendations for the Ceramic Glass Cooktop

CAUTION

Before cleaning the cooktop, be sure the controls are turned to **OFF** and the cooktop is **COOL**.

WARNING

DO NOT use a cooktop cleaner on a hot cooktop. The fumes can be hazardous to your health, and can chemically damage the ceramic glass surface.

For light to moderate soil:

Apply a few drops of CookTop® Cleaning Creme directly to the cooktop. Use a paper towel or use a **non-abrasive** plastic type **no-scratch** pad to clean the entire cooktop surface. Make sure the cooktop is cleaned thoroughly, leaving no residue.

For heavy, burned on soil:

Apply a few drops of CookTop® Cleaning Creme directly to the soiled area. Rub the soiled area using a **non-abrasive** plastic type **no-scratch** pad, applying pressure as needed. Do not use the pad you use to clean the cooktop for any other purpose.

IMPORTANT

Damage to the ceramic glass cooktop may occur if you use an abrasive type scratch pad. Only use cleaning products that have been specifically designed for ceramic glass cooktop.

If soils remain, carefully scrape soils with a metal razor blade scraper, holding scraper at a 30 degree angle to the surface. Remove loosened soils, then apply a few drops of cleaning cream and buff surface clean.

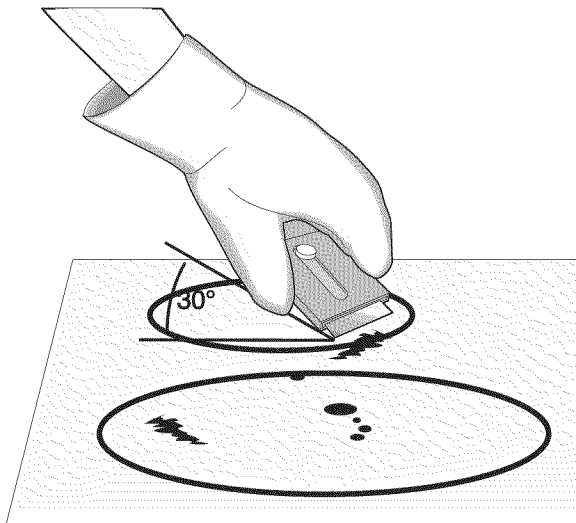

Plastic or foods with a high sugar content:

These types of soils need be removed immediately if spilled or melted onto the ceramic cooktop surface. Permanent damage (such as pitting of the cooktop surface) may occur if not removed **immediately**. After turning the surface elements **OFF**, use a razor blade scraper or a metal spatula with a mitt and scrape the soil from the hot surface (as illustrated). Allow the cooktop to cool, and use the same method for heavy or burned on soils.

Do not use the following on the ceramic glass cooktop:

- Do not use abrasive cleaners and scouring pads, such as metal and some nylon pads. They may scratch the cooktop, making it more difficult to clean.
- Do not use harsh cleaners, such as chlorine bleach, ammonia or oven cleaners, as they may etch or discolor the cooktop.
- Do not use dirty sponges, cloths or paper towels, as they can leave soil or lint on the cooktop which can burn and cause Special Caution for Aluminum Foil and Aluminum Cooking Utensils

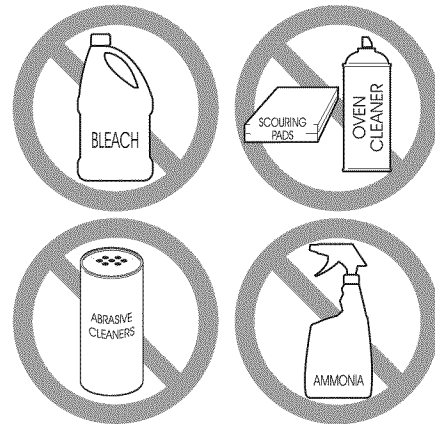

• Aluminum foil

Use of aluminum foil will damage the cooktop. Do not use under any circumstances.

• Aluminum utensils

Since the melting point of aluminum is much lower than that of other metals, care must be taken when aluminum pots or pans are used. Pans that boil dry may permanently damage cooktop by breaking, fusing to, or marking it.

Care and Cleaning of Stainless Steel

Some models are equipped with stainless steel exterior parts. Special care and cleaning are **required** for maintaining the appearance of stainless parts. Refer to the **General Care & Cleaning** table for detailed cleaning instructions.

BEFORE YOU CALL (Solutions to Common Problems)

IMPORTANT

Before you call for service, review this list. It may save you time and expense. The list includes common occurrences that are not the result of defective workmanship or materials in this appliance.

OCCURRENCE	POSSIBLE CAUSE/SOLUTION
Entire cooktop does not operate.	House fuse has blown or circuit breaker has tripped. Check/reset breaker or replace fuse. If the problem is a circuit overload, have this situation corrected by a qualified electrician. Service wiring not complete. Contact installation agent or dealer. Power outage. Check house lights to be sure. Call local electric company.
Surface element does not heat.	No power to appliance. Check/reset breaker or replace fuse. If the problem is a circuit overload, or improper connection of the armored cable supplied with the appliance, have this situation corrected by a qualified electrician. Too low heat setting. Turn control to a slightly higher setting until element comes on. Incorrect control is on. Be sure to use correct control for the element to be used. No cookware was placed on the induction cooking zones or the cookware material type is incorrect for induction cooking.
Surface element too hot or not hot enough.	Incorrect control setting. Raise or lower setting until proper amount of heat is obtained. Dial markings are an indicator of relative heat settings and will vary slightly. Lightweight or warped pans being used. Use only flat, evenly balanced, medium or heavyweight cookware. Voltage is incorrect. Be sure appliance is properly connected to the specified power source. Use only flat bottom, evenly balanced, medium or heavyweight cookware. Pans having a flat bottom heat better than warped pans. Cookware material affects heating. Heavy and medium weight pans heat evenly. Because lightweight pans heat unevenly, foods may burn easily.
Food not heating evenly.	Improper cookware. Select flat-bottomed cookware of a proper size to fit element. Incorrect control setting. Raise or lower setting until proper amount of heat is obtained.
Scratches or abrasions on ceramic glass cooktop surface.	Coarse particles (such as salt or sand) are between cooktop and utensil. Be sure cooktop surface and bottom of utensils are clean before use. Small scratches do not affect cooking and will become less visible with use. Cleaning materials not recommended for glass ceramic cooktop have been used. See Ceramic-Glass Cooktop section in this Owner's Guide. Cookware with rough bottom has been used. Use flat-bottomed, smooth utensils. See Selecting Surface Cooking Utensils in this Owner's Guide.
Metal marks on ceramic glass cooktop surface.	Sliding or scraping of metal utensils on cooktop surface. Do not slide metal utensils on cooktop surface. Use a mildly abrasive cleanser to remove marks.
Brown streaks and specks on ceramic glass cooktop surface.	Boilovers have cooked onto surface. Use razor blade scraper to remove soil. See Ceramic-Glass Cooktop section in this Owner's Guide. Cleaning materials not recommended for ceramic-glass cooktop have been used. Use recommended cleaners and cleaning method. See Ceramic-Glass Cooktop section in this Owner's Guide.
Areas of discoloration on ceramic glass cooktop surface.	Mineral deposits from water and food. Wet surface with water and sprinkle on a cooktop cleaning creme. Scrub with a clean damp paper towel until the stain disappears. Wipe remaining paste away, then apply a small amount of cooktop cleaning creme and polish with a clean paper towel. Use cookware with clean, dry bottoms. See Ceramic-Glass Cooktop section in this Owner's Guide.

MAJOR APPLIANCE WARRANTY

Your appliance is covered by a one year limited warranty. For one year from your original date of purchase, Electrolux will pay all costs for repairing or replacing any parts of this appliance that prove to be defective in materials or workmanship when such appliance is installed, used and maintained in accordance with the provided instructions.

Exclusions This warranty does not cover the following:

- 1 Products with original serial numbers that have been removed, altered or cannot be readily determined.
- 2 Product that has been transferred from its original owner to another party or removed outside the USA or Canada.
- 3 Rust on the interior or exterior of the unit.
- 4 Products purchased "as-is" are not covered by this warranty.
- 5 Food loss due to any refrigerator or freezer failures.
- 6 Products used in a commercial setting.
- 7 Service calls which do not involve malfunction or defects in materials or workmanship, or for appliances not in ordinary household use or used other than in accordance with the provided instructions.
- 8 Service calls to correct the installation of your appliance or to instruct you how to use your appliance.
- 9 Expenses for making the appliance accessible for servicing, such as removal of trim, cupboards, shelves, etc., which are not a part of the appliance when it is shipped from the factory.
- 10 Service calls to repair or replace appliance light bulbs, air filters, water filters, other consumable, or knobs, handles, or other cosmetic parts.
- 11 Surcharges including, but not limited to, any after hour, weekend, or holiday service calls, tolls, ferry trip charges, or mileage expense for service calls to remote areas, including the state of Alaska.
- 12 Damages to the finish of appliance or home incurred during installation, including but not limited to floors, cabinets, walls, etc.
- 13 Damages caused by: services performed by unauthorized service companies; use of parts other than genuine Electrolux parts or parts obtained from persons other than authorized service companies; or external causes such as abuse, misuse, inadequate power supply, accidents, fires, or acts of God.

DISCLAIMER OF IMPLIED WARRANTIES; LIMITATION OF REMEDIES

Customer's sole and exclusive remedy under this limited warranty shall be product repair or replacement as provided herein. Claims based on implied warranties, including warranties of merchantability or fitness for particular purpose, are limited to one year or the shortest period allowed by law, but not less than one year. Electrolux shall not be liable for consequential or incidental damages such as property damage and incidental expenses resulting from any breach of this written limited warranty or any implied warranty. Some states and provinces do not allow the exclusion or limitation of incidental or consequential damages, or limitations on the duration of implied warranties, so these limitations or exclusions may not apply to you. This written warranty gives you specific legal rights. You may also have other rights that vary from state to state.

If You Need Service

Keep your receipt, delivery slip, or some other appropriate payment record to establish the warranty period should service be required. If service is performed, it is in your best interest to obtain and keep all receipts. Service under this warranty must be obtained contacting Electrolux at the addresses or phone numbers below.

This warranty only applies in the USA and Canada. In the USA, your appliance is warranted by Electrolux Major Appliances North America, a division of Electrolux Home Products, Inc. In Canada, your appliance is warranted by Electrolux Canada Corp. Electrolux authorizes no person to change or add to any obligations under this warranty. Obligations for service and parts under this warranty must be performed by Electrolux or an authorized service company. Product features or specifications as described or illustrated are subject to change without notice.

USA
1.800.944.9044
Electrolux Major Appliances
North America
P.O. Box 212378
Augusta, GA 30907



Canada
1.800.265.8352
Electrolux Canada Corp.
5855 Terry Fox Way
Mississauga, Ontario, Canada
L5V 3E4