

Installation Instructions

30" (76.2 cm) Freestanding Gas Range with standard clean oven

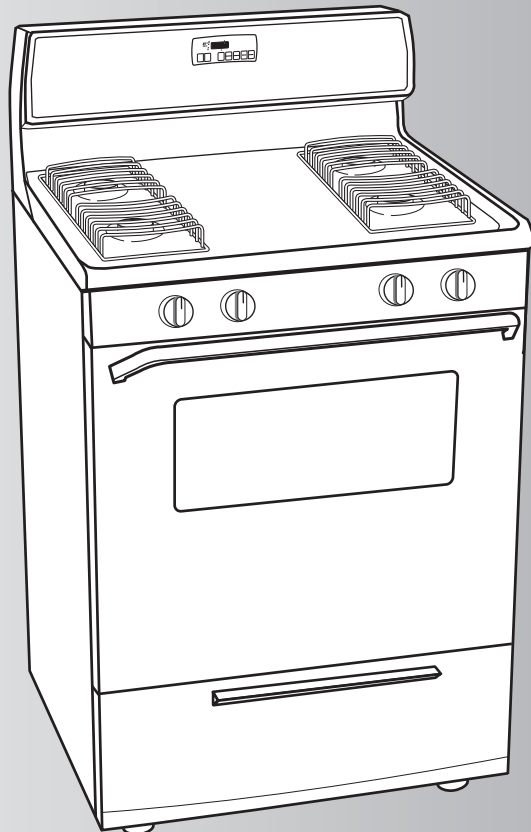

Quick Reference

Table of Contents:

Pages	
2	Before you start
3	Product dimensions
3	Cutout dimensions/requirements
4	Electrical requirements
4 - 5	Gas supply requirements
5 - 7	Installation steps
8 - 9	Gas conversions
10	Moving the range
11	If range does not operate
11	If you need assistance/service



! WARNING



Tip Over Hazard

A child or adult can tip the range and be killed.

Connect anti-tip bracket to rear range foot.

Reconnect the anti-tip bracket, if the range is moved.

Failure to follow these instructions can result in death or serious burns to children and adults.

IMPORTANT: Read and save these instructions.

IMPORTANT:

Installer: Leave Installation Instructions with the homeowner.

Homeowner: Keep Installation Instructions for future reference. Save Installation Instructions for local electrical inspector's use.

Write down the model and serial numbers before installing range.

Both numbers are on the model/serial rating plate, located on the oven frame behind the left side of the broiler door.

Model # _____

Serial # _____

www.whirlpool.com

Part No. 98014109

Before you start...

Your safety and the safety of others are very important.

We have provided many important safety messages in this manual and on your appliance. Always read and obey all safety messages.



This is the safety alert symbol.

This symbol alerts you to potential hazards that can kill or hurt you and others.

All safety messages will follow the safety alert symbol and either the word "DANGER" or "WARNING". These words mean:

! DANGER

You can be killed or seriously injured if you don't immediately follow instructions.

! WARNING

You can be killed or seriously injured if you don't follow instructions.

All safety messages will tell you what the potential hazard is, tell you how to reduce the chance of injury, and tell you what can happen if the instructions are not followed.

WARNING: If the information in this manual is not followed exactly, a fire or explosion may result causing property damage, personal injury or death.

— Do not store or use gasoline or other flammable vapors and

liquids in the vicinity of this or any other appliance.

— WHAT TO DO IF YOU SMELL GAS

- Do not try to light any appliance.
 - Do not touch any electrical switch.
 - Do not use any phone in your building.
 - Immediately call your gas supplier from a neighbor's phone. Follow the gas supplier's instructions.
 - If you cannot reach your gas supplier, call the fire department.
- Installation and service must be performed by a qualified installer, service agency or the gas supplier.

Important: Observe all governing codes and ordinances.

Do not obstruct flow of combustion and ventilation air.

This installation must conform with all local codes and ordinances. In the absence of local codes, installation must conform with American National Standard, National Fuel Gas Code ANSI Z223.1 — latest edition*.

It is the customer's responsibility:

- To contact a qualified electrical installer.
- To assure that the electrical installation is adequate and in conformance with National Electrical Code, ANSI/NFPA 70 — latest edition**, and all codes and ordinances.

Cabinet opening dimensions shown must be used. Given dimensions are minimum clearances.

When installing a range under existing cabinets and the installation does not meet the minimum cabinet clearances, install a range hood above the cooktop to avoid burn hazards.

Proper installation is your responsibility. A qualified technician must install this range. Make sure you have everything necessary for correct installation. It is the installer's responsibility to comply with installation clearances specified on the gas information label. The gas information label and model/serial rating plate are located on the frame behind the broiler door.

Mobile home installation

The installation of this range must conform with the Manufactured Home Construction and Safety Standard, Title 24 CFR, Part 3280 [formerly the Federal Standard for Mobile Home Construction and Safety, Title 24, HUD (Part 280)] or, when such standard is not applicable, the Standard for Manufactured Home Installations, ANSI/NCSCS A225.1 and Manufactured Home Installations, Sites, and Communities ANSI/NFPA 501A**, or with local codes.

When this range is installed in a mobile home, it must be secured to the floor during transit. Any method of securing the range is adequate as long as it conforms to the standards listed above.

Copies of the standards listed may be obtained from:

* CSA International
8501 East Pleasant Valley Road
Cleveland, Ohio 44131-5575

** National Fire Protection Association
One Batterymarch Park
Quincy, Massachusetts 02269

Tools and materials needed:

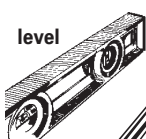

level

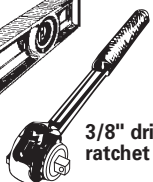

3/8" drive ratchet



hand or electric drill



wood floor: 1/8" drill bit



concrete/ceramic floors: 3/16" carbide-tipped masonry drill bit (Hammer may be needed for anchors.)



flat-blade screwdriver



Phillips screwdriver

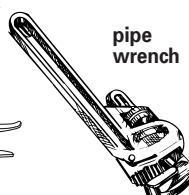

pipe wrench

gloves



tape measure or ruler



slip-joint pliers

Materials required:

- gas line shutoff valve
- 1/2" male pipe thread nipple for connection to pressure regulator
- L.P. gas-resistant pipe-joint compound
- CSA design-certified flexible metal appliance connector (4-5 feet) or rigid gas supply line as needed
- Insulated pad or 1/4" plywood if range is installed over carpeting

1/2" and 3/8" combination wrench

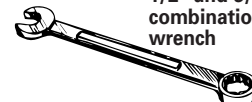

safety glasses



Parts supplied for installation:

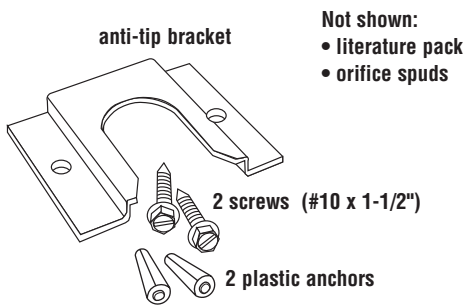

(Bracket must be securely mounted to sub-floor. Thickness of flooring may require longer screws to anchor the bracket to sub-floor.)

Product dimensions

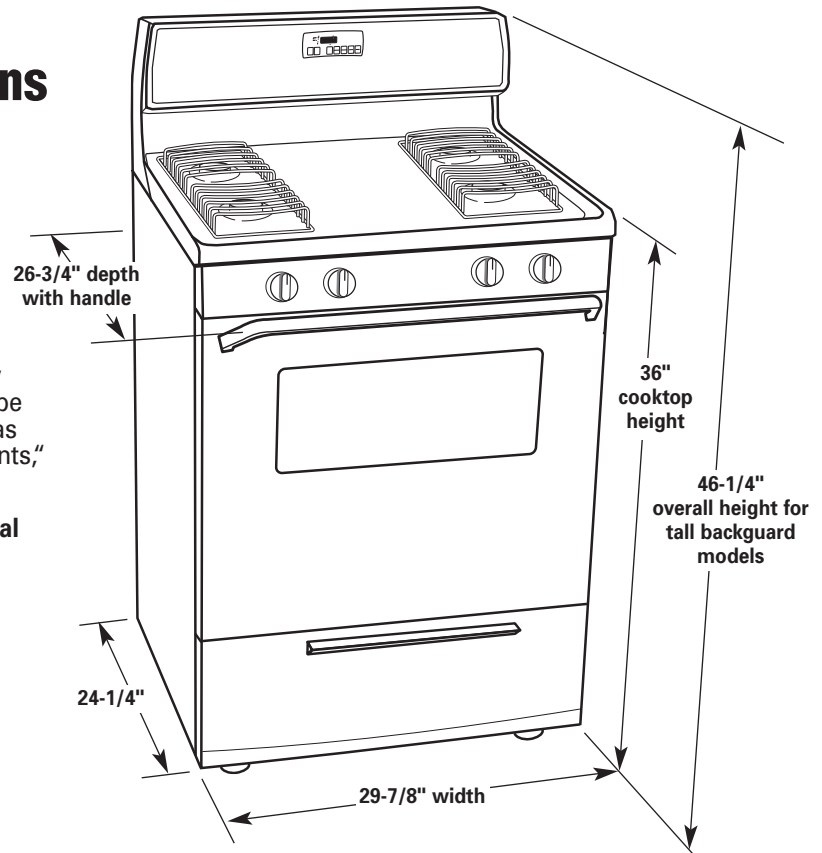

Proper gas supply connection must be available. See "Gas supply requirements," Page 4.

Grounded electrical outlet is required. See "Electrical requirements," Page 4.

Cutout dimensions/requirements

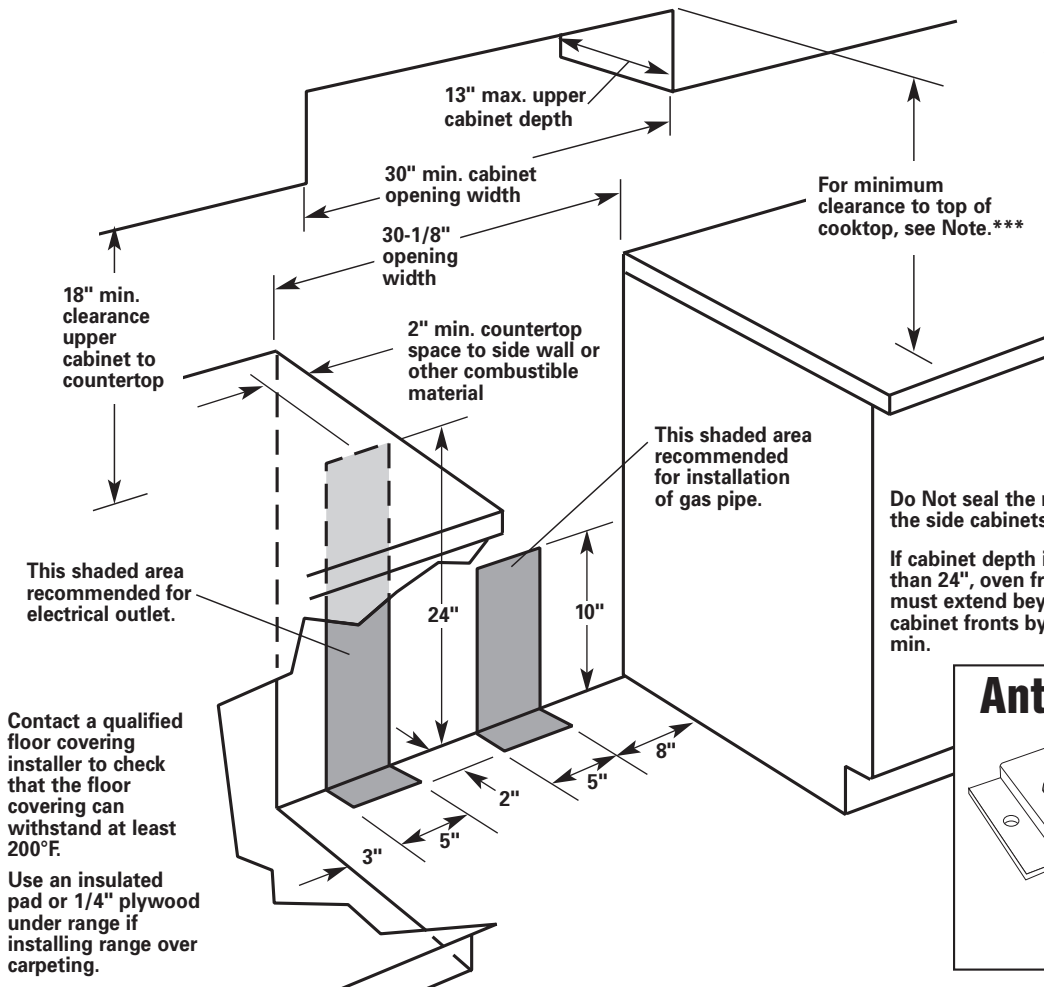

Check location where range will be installed. The range should be located for convenient use in the kitchen. Recessed installations must provide complete enclosure of the sides and rear of range. **ALL OPENINGS IN THE WALL OR FLOOR WHERE RANGE IS TO BE INSTALLED MUST BE SEALED.**

IMPORTANT: Some cabinet and building materials are not designed to withstand the heat produced by the oven for baking and self-cleaning. Check with your builder or cabinet supplier to make sure that the materials used will not discolor, delaminate or sustain other damage.

*** Note: 24" min. when bottom of wood or metal cabinet is protected by not less than 1/4" flame retardant millboard covered with not less than No. 28 MSG sheet steel, 0.015" stainless steel, 0.024" aluminum or 0.020" copper.

30" min. clearance between the top of the cooking platform and the bottom of an unprotected wood or metal cabinet.

Do Not seal the range to the side cabinets.

If cabinet depth is greater than 24", oven frame must extend beyond cabinet fronts by 1/2" min.

Anti-tip bracket:

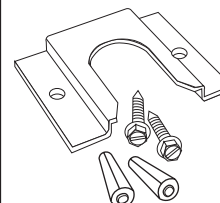

The floor anti-tip bracket **MUST** be installed. To install the anti-tip bracket shipped with the range, see Page 7 and the anti-tip bracket template.

Electrical requirements

⚠️ WARNING



Electrical Shock Hazard
Plug into a grounded 3-prong outlet.
Do not remove ground prong.
Do not use an adapter.
Do not use an extension cord.
Failure to follow these instructions can result in death, fire, or electrical shock.

If codes permit and a separate ground wire is used, it is recommended that a qualified electrician determine that the ground path is adequate.

Do Not ground to a gas pipe.

Check with a qualified electrician if you are not sure range is properly grounded.

A 120-volt, 60-Hz, AC-only, 10-ampere, fused electrical supply is required. A time-delay fuse or circuit breaker is recommended. It is recommended that a separate circuit serving only this appliance be provided.

Electronic ignition systems operate within wide voltage limits, but proper grounding and polarity are necessary. In addition to checking that the outlet is correctly grounded, the outlet must be checked by a qualified electrician to see if it is wired with correct polarity.

Important: This range is equipped with an electronic ignition system that will not operate if plugged into an outlet that is not properly polarized.

A wiring diagram is included on the back of the range.

See "Cabinet dimensions/requirements," Page 3, for recommended location of electrical outlet.

Recommended ground method

For personal safety, this range is equipped with a power supply cord having a 3-prong ground plug. To minimize possible shock hazard, the cord must be plugged into a mating 3-prong, ground-type outlet, grounded in accordance with the National Electrical Code, ANSI/NFPA 70 — latest edition* and all local codes and ordinances.

If a mating outlet is not available, it is the personal responsibility and obligation of the customer to have a properly polarized and grounded, 3-prong outlet installed by a qualified electrician.

Copies of the standards listed may be obtained from:

*National Fire Protection Association
One Batterymarch Park
Quincy, Massachusetts, 02269

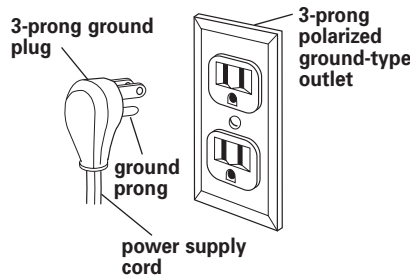

Gas supply requirements

⚠️ WARNING



Explosion Hazard

Use a new CSA approved gas supply line.

Install a shut-off valve.

Securely tighten all gas connections.

If connected to LP, have a qualified person make sure gas pressure does not exceed 14" water column.

Examples of a qualified person include:

licensed heating personnel;
authorized gas company personnel;
and, authorized service personnel.

Failure to do so can result in death, explosion, or fire.

In the State of Massachusetts, the following installation instructions apply:

- Installations and repairs must be performed by a qualified or licensed contractor, plumber, or gasfitter qualified or licensed by the State of Massachusetts.
- If using a ball valve, it shall be a T-handle type.
- A flexible gas connector, when used, must not exceed 3 feet.

Observe all governing codes and ordinances.

This installation must conform with all local codes and ordinances. In the absence of local codes, installation must conform with American National Standard, National Fuel Gas Code ANSI Z223.1 — latest edition*.

Input ratings shown on the model/serial rating plate are for elevations up to 2,000 feet. For assistance when installing the range at higher elevations, contact your local service company.

Type of gas: This range is design-certified by CSA International for use with Natural gas or, after proper conversion, for use with L.P. gas. This range is factory set for use with Natural gas. Gas conversion instructions are provided on pages 8-9. The model/serial rating plate located on the frame behind the broiler drawer has information on the type of gas that can be used. If the type of gas listed does not agree with the type of gas available, check with the local gas supplier.

Conversion must be done by a qualified service technician.

Gas supply line: Provide a gas supply line of 3/4" rigid pipe to the range location. With L.P. gas, piping or tubing size can be 1/2" minimum. A smaller size pipe on longer runs may result in insufficient gas supply. Usually, L.P. gas suppliers determine the size and materials used in the system.

Pipe-joint compounds made for use with L.P. gas must be used on pipe threads only.

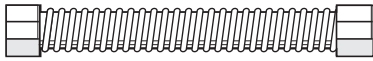

Flexible metal appliance connector: If local codes permit, a new CSA design-certified, 1/2" or 3/4" I.D., flexible metal appliance connector is recommended for connecting range to the gas supply line. A 1/2" male pipe thread nipple is needed for connection to pressure regulator connection fitting. **Do Not kink or damage the flexible metal tubing when moving the range.**



Rigid pipe connection: Requires a combination of pipe fittings to obtain an in-line connection to the range. All strains must be removed from the supply and fuel lines so range will be level and in line.

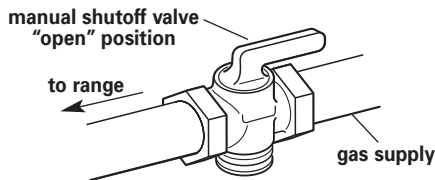

Shutoff valve: The supply line must be equipped with a manual shutoff valve. This valve should be located in the same room as the range and should be in a location that allows ease of opening and closing. The valve is for turning on or shutting off gas to the range. **Do Not block access to shutoff valve.**

Pressure regulator: The gas pressure regulator supplied with this range must be used. The inlet pressure to the regulator should be as follows for proper operation:

NATURAL GAS:

- Minimum pressure: 5 inches WCP
- Maximum pressure: 14 inches WCP

L.P. GAS:

- Minimum pressure: 11 inches WCP
- Maximum pressure: 14 inches WCP

Contact local gas supplier if you are not sure about the inlet pressure.

Line pressure testing above 1/2 psi gauge (14" WCP) —The range and its individual manual shutoff valve must be disconnected from the gas supply piping system during any pressure testing of that system at test pressures greater than 1/2 psig (3.5 kPa).

Line pressure testing at 1/2 psi gauge (14" WCP) or lower —The range must be isolated from the gas supply piping system by closing its individual manual shutoff valve during any pressure testing of that system at test pressures equal to or less than 1/2 psig (3.5 kPa).

Copies of the standards listed may be obtained from:

* CSA International
8501 East Pleasant Valley Road
Cleveland, Ohio 44131-5575

Now start...

⚠ WARNING

Excessive Weight Hazard

Use two or more people to move and install range.

Failure to do so can result in back or other injury.

1. Put on safety glasses and gloves. Do Not use oven door handle to lift or move the range.

2. Remove oven racks and parts package from inside oven. Remove shipping materials, tape and protective film from range.

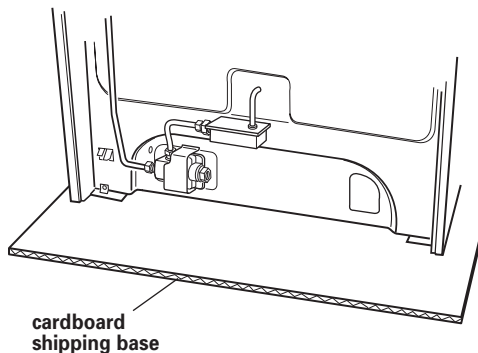

3. Keep cardboard shipping base under range to prevent damage to floor covering.

⚠ WARNING

Tip Over Hazard

A child or adult can tip the range and be killed.

Connect anti-tip bracket to rear range foot.

Reconnect the anti-tip bracket, if the range is moved.

Failure to follow these instructions can result in death or serious burns to children and adults.

Contact a qualified floor covering installer for the best procedure for drilling mounting holes through your type floor covering.

4. Use the anti-tip bracket template/instruction sheet to install the anti-tip bracket.

Anti-tip bracket must be anchored securely to the sub floor.

Depending on the thickness of your flooring, longer screws may be needed to anchor the bracket to the sub floor. Longer screws are available from your local hardware store.

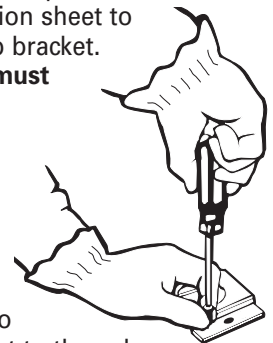

5. Check that range is still on cardboard shipping base to protect floor covering. Move range close to final location.

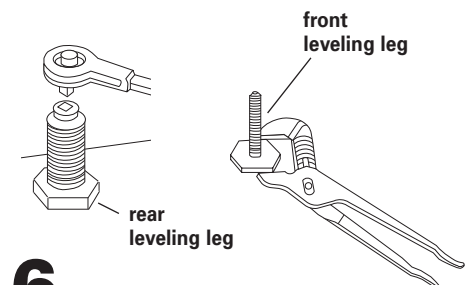

6. Remove cardboard shipping base from under range. Open broiler door. Use a 3/8" drive ratchet to lower rear leveling legs one-half turn. Use slip-joint pliers to lower front leveling legs one-half turn.

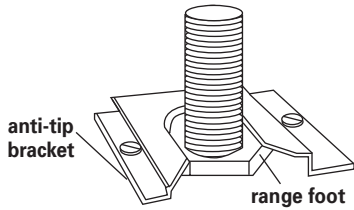

7. Making sure the anti-tip bracket is installed:

- Look for the anti-tip bracket securely attached to floor.
- Slide range back so rear range foot is under anti-tip bracket.

8. If installing the range in a mobile home, you MUST secure the range to the floor. Any method of securing the range is adequate as long as it conforms to the "Manufactured Home Construction and Safety Standard," Page 2.

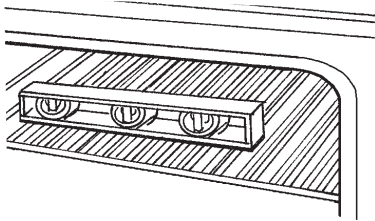

9. Place rack in oven. Place level on rack, first side to side; then front to back. If range is not level, pull range forward until rear leveling leg is removed from the anti-tip bracket. Use 3/8" drive ratchet and channel lock pliers to adjust leveling legs up or down until range is level. Push range back into position. Check that rear leveling leg is engaged in anti-tip bracket.

Note: Oven must be level for satisfactory baking conditions.

Gas and electrical connection

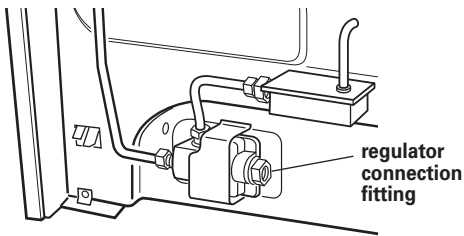

10. Assemble the flexible connector to the gas supply pipe to the pressure regulator connection fitting, using the adapter fittings provided with the flexible connector. Use pipe-joint compound made for use with L.P. gas to seal all pipe thread connections.

All connections must be wrench-tightened.

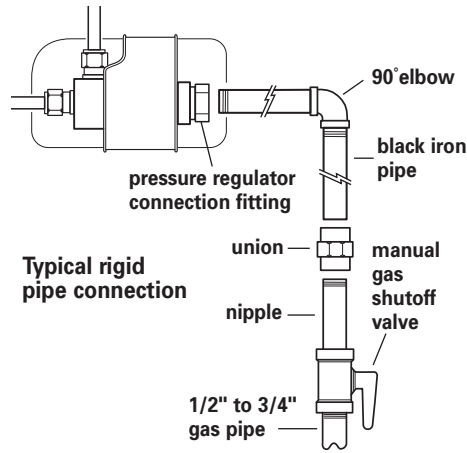

Typical rigid pipe connection

Typical flexible connection

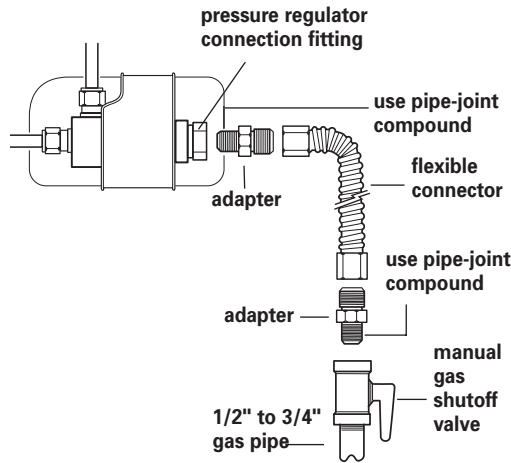

A 1/2" male pipe thread is needed for connection to pressure regulator female pipe threads.

11. If a flexible appliance connector is used, be certain connector is not kinked.

12. Check that all control knobs are in the "OFF" position.

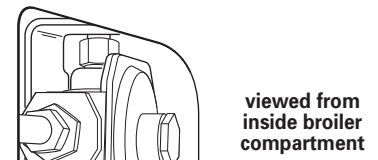

viewed from inside broiler compartment

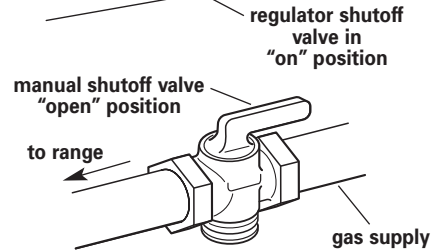

13. Check that range regulator shutoff valve is in the "on" position. Open the manual shutoff valve in the gas supply line.

14. Test all connections by brushing on an approved non-corrosive leak-detection solution. Bubbles will show a leak. If a leak appears, shut off gas supply valve and tighten connections. Then check connections again. **Never test for gas leaks with a match or other flame.** Clean all leak-detection solution from gas connections. Close broiler door.

15. Place burners, burner caps and grates on cooktop.

16. Plug power supply cord into grounded electrical outlet.

Check operation

Electronic ignition system

Cooktop and oven burners use electronic ignitors in place of standing pilots. When a cooktop control knob is turned to the "LITE" position, the system creates a spark to light the burner. This sparking continues until the control knob is turned to the desired setting.

When the oven control is turned to the desired setting, a hot surface ignitor heats to a bright orange and ignites the gas. No sparking occurs. The glow bar remains on while the burner operates.

Check operation of cooktop

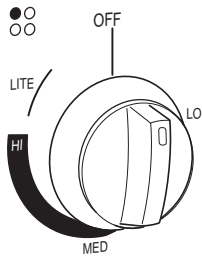

17. Push in and turn each surface unit control knob to “LITE” position. The flame should light within 4 seconds. Turn control knob to “HI” position after burner lights.

Check each cooktop burner for proper flame.

The small inner cone should have a very distinct blue flame 1/4" to 1/2" long. The outer cone is not as distinct as the inner cone. If the flame is noisy or blowing, it is getting too much air. If the flame is soft and lazy, it is not getting enough air. Turn each surface burner control knob to “OFF” position. Adjust air shutter if needed.



If surface burner air shutters need adjusting:

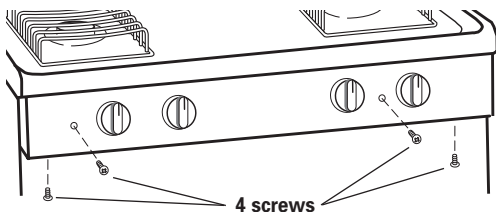

a. Remove control knobs and 4 screws that attach control panel to range cabinet. Pull control panel forward to remove. Set panel, screws and knobs aside.

b. Replace control knob for burner to be adjusted. Push knob in and turn to “LITE” position. When burner lites, turn to “HI” position.

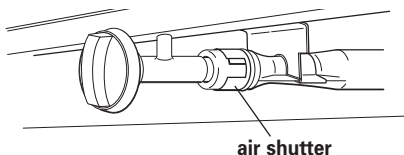

c. Adjust the air shutter by hand as needed. Close the air shutter to decrease the amount of air to the flame. Open the air shutter to increase the amount of air to the flame.

Adjust the air shutter to the widest opening that will not cause the flame to lift or blow off the burner.

Turn burner off and remove knob.

As needed, adjust other air shutters.

18. Replace control panel and tighten screws securely. Replace control knobs.

19. Push in and turn each cooktop control knob from “LITE” to “LO” setting quickly. The low flame should be a minimum, steady blue flame. If flame needs to be adjusted, turn control knob to the “LO” setting and remove control knob. Insert a small flat-blade screwdriver into the valve stem. Turn the valve screw to obtain the smallest flame that will not go out when the control of a cold burner is quickly turned from “HI” to “LO”. Repeat for other cooktop burners as needed.

Check operation of oven/broil burner

20. Open broiler door.

- Press the “BAKE” pad.
 - The “BAKE” indicator will light.
 - “350” will appear in the display.
- Press the START/ENTER pad.
 - The “TEMP” and “ON” indicators will appear.
 - The display will show the automatic countdown time (10 minutes) needed to preheat the oven for selected temperature.
 - The oven burner should light in 20-40 seconds; this delay is normal.** The oven valve requires a certain time before it will open and allow gas to flow.

The oven burner will burn until oven temperature has reached 350°F. After 20-40 seconds, the oven burner will begin to cycle on and off to maintain the 350°F temperature.

Broil burner and oven burner are the same burner. Check the broil function as follows:

- Press the “BROIL” pad.
 - “525” will appear in the display.
 - The “BROIL” indicator will light.
- Press the “START/ENTER” pad.
 - “TEMP” and “ON” indicators will light.
 - The oven burner should light in 20-40 seconds; this delay is normal.** The oven valve requires a certain time before it will open and allow gas to flow.

To avoid damaging the hot surface ignitor, do Not insert any object into the openings of the protective shield that surrounds the ignitor or clean that area.

21. Check the oven burner for proper flame. The flame should be 1/2" long, with inner cone of bluish-green, and outer mantle of dark blue, and should be clean and soft in character. No yellow tips (not enough air), blowing or lifting (too much air) of flame should occur.

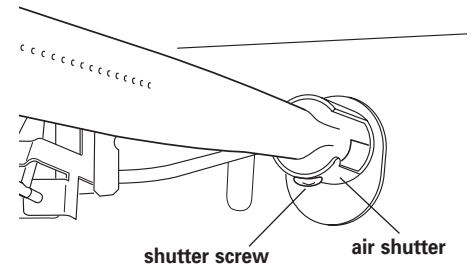

If oven flame needs adjusting:

- Turn the oven off.
- Wait for the oven burner to cool down.
- Locate the air shutter near the rear wall of oven and loosen the shutter screw.
- Adjust the air shutter.
- Turn the oven back on and check for proper flame. If the flame is still not properly adjusted, turn the oven off, wait for the oven burner to cool down and repeat Step “d” until flame is properly adjusted.
- When the flame has been properly adjusted, turn the oven off, wait for the burner to cool down and tighten the shutter screw.

22. Close broiler door. Press the “OFF” pad.

You have just finished installing your new range. To get the most efficient use from your range, read your Use & Care Guide. Keep Installation Instructions and Guide close to range for easy reference.

The instructions will make installing the range in another home as easy as the first installation.

Gas conversion

Gas conversions (from Natural gas to L.P. gas; or from L.P. gas to Natural gas) must be done by a qualified installer.

⚠ WARNING



Fire Hazard

Shut off gas supply line valve.
Make all conversions before turning gas supply valve back on.
Failure to follow these instructions can result in explosion, fire or other injury.

L.P. gas conversion

1. Complete installation Steps 1-9 (Pages 5-6) before converting cooktop to L.P. gas. **Check that the manual shutoff valve in the gas supply line has been turned off.**

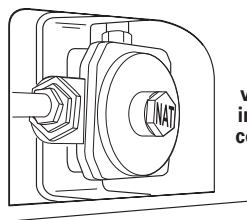

viewed from inside broiler compartment

2. Open broiler drawer and remove broiler pan. The pressure regulator is located in the back right hand corner of the broiler compartment.

DO NOT REMOVE THE PRESSURE REGULATOR.

3. Pressure regulator: Remove the cap from the pressure regulator. Turn the cap over so that LP is visible. Replace the cap.

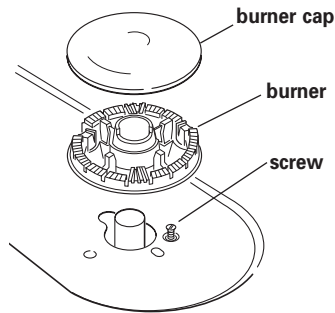
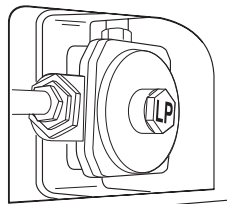

4. Remove burner grates, burner caps, burners and screws. Lift cooktop. Note: There is no cooktop support rod.

5. Cooktop burners:

- Check that all control knobs are in the OFF position and remove the knobs.
- Remove the control panel. (See Step 17a, Page 7.)

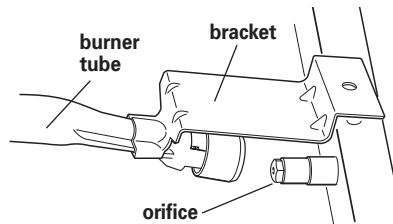

c. Lift front of bracket and push tube and bracket assembly back off orifice.

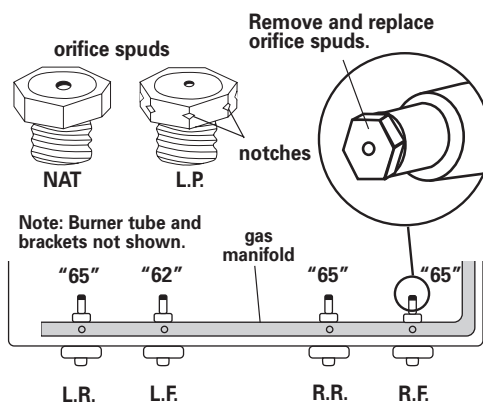

d. Locate L.P. gas orifice spuds for top burners in literature package included with the range. Three L.P. gas spuds are stamped "65" and one "62". Remove Natural gas orifice spuds using a 3/8" combination wrench. Install L.P. gas orifice spuds in locations shown to replace the Natural gas orifice spuds. Note: Depending on model, the range cooktop may be equipped with 4 standard burners or 3 standard burners and 1 power burner. Spud size/location remain the same.

Place Natural gas orifice spuds in plastic parts bag for future use and keep with literature package.

Reinstall burner tube and bracket assemblies.

e. Lower cooktop. Reinstall screws to secure burner tubes to cooktop. Reinstall burners, burner caps and burner grates.

Do not reinstall control panel or knobs. They will be reinstalled in Step 10, Page 9.

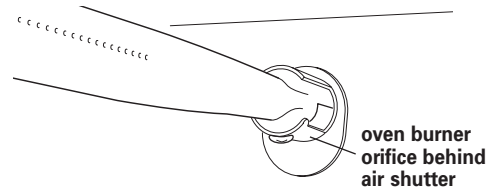

L.P. oven orifice spud stamped with "56"

6. Oven burner:

- Carefully pull oven burner away from back wall of oven just enough to access the orifice spud located behind the burner's air shutter.
- Locate L.P. gas orifice spud stamped "56" in literature package supplied with range.

c. Use a 3/8" combination wrench and remove the natural gas orifice spud. Install the number "56" L.P. gas spud.

Place natural gas oven burner spud in plastic parts bag along with natural gas cooktop burner spuds for future use and keep with literature package.

d. Reinstall the oven burner.

7. Turn manual shutoff valve in gas supply line on. If "Gas and electrical connection" Steps 10-16 on Page 6 were not completed, complete them now.

8. Install control knobs. Check for proper flame. The cooktop burner flames should have a small inner cone with a very distinct blue flame 1/4" to 1/2" long. The outer cone is not as distinct as the inner cone. The oven burner flame should be 1/2" long with a bluish-green inner cone and dark blue outer mantle. L.P. gas flames have a slightly yellow tip. If the flames are noisy or blowing, they are getting too much air. If the flames are soft and lazy, they are not getting enough air. If burners need adjusting, see "Check operation" section, Steps 17-22, Page 7.

9. Close the broiler door. Press the "OFF" pad.

10. Remove control knobs. Reinstall the control panel. Securely tighten the 4 screws. Reinstall the control knobs. **Important:** If not done in Step 8, check the "LO" flame adjustment. See "Check operation" section, Step 19, Page 7.

Natural gas conversion

1. Check that the manual shutoff valve in the gas supply line has been turned off.

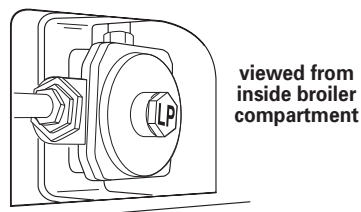

2. Open broiler drawer and remove broiler pan. The pressure regulator is located in the back right hand corner of the broiler compartment.

DO NOT REMOVE THE PRESSURE REGULATOR.

3. **Pressure regulator:** Remove the cap from the pressure regulator. Turn the cap over so that N or NAT is visible. Replace the cap.

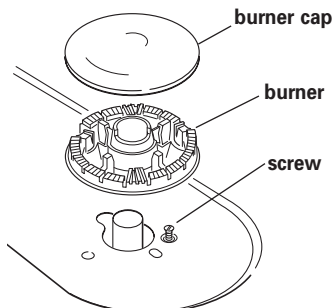
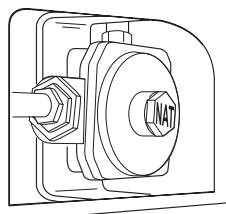

4. Remove burner grates, burner caps, burners and screws. Lift cooktop. Note: There is no cooktop support rod.

5. **Cooktop burners:**

a. Check that all control knobs are in the OFF position and remove the knobs.

b. Remove the control panel. (See Step 17a, Page 7.)

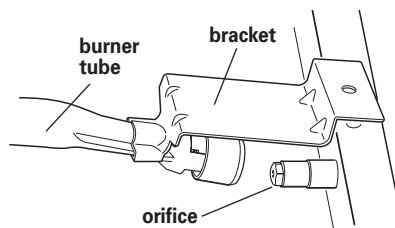

c. Lift front of bracket and push tube and bracket assembly back off orifice.

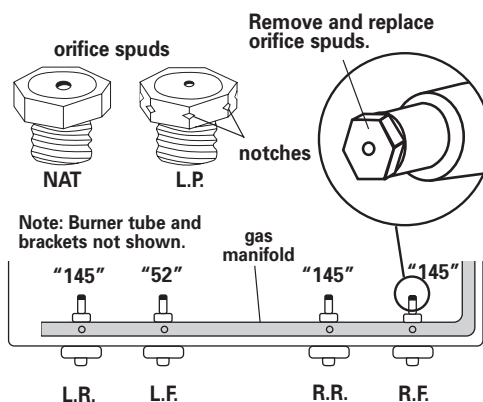

d. Locate Natural gas orifice spuds for top burners in literature package included with the range. Three Natural gas spuds are stamped "145" and one "52." Remove Natural gas orifice spuds using a 3/8" combination wrench. Install Natural gas orifice spuds in locations shown to replace the L.P. gas orifice spuds. Note: Depending on model, the range cooktop may be equipped with 4 standard burners or 3 standard burners and 1 power burner. Spud size/location remain the same.

Place L.P. gas orifice spuds in plastic parts bag for future use and keep with literature package.

Reinstall burner tube and bracket assemblies.

e. Lower cooktop. Reinstall screws to secure burner tubes to cooktop. Reinstall burners, burner caps and burner grates.

Do not reinstall control panel or knobs. They will be reinstalled in Step 10, on Page 9.

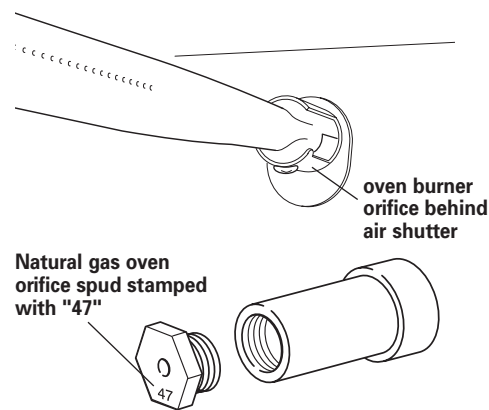

6. **Oven burner:**

a. Open oven door and remove oven racks, oven tray, flame spreader and set aside. Lift oven burner. The orifice spud is behind the oven burner air shutter.

b. Locate Natural gas orifice spud stamped "47" in literature package supplied with range.

c. Use a 3/8" combination wrench and remove the L.P. gas orifice spud. Install the number "47" Natural gas spud.

Place L.P. gas oven burner spud in plastic parts bag along with L.P. gas cooktop burner spuds for future use and keep with literature package.

d. Reinstall the oven burner.

7. Turn manual shutoff valve in gas supply line on. If "Gas and electrical connection" Steps 10-16 on Page 6 were not completed, complete them now.

8. Install control knobs. Complete "Check operation" section, Steps 17-22, Page 7. Check for proper flame. Natural gas flames do not have yellow tips.

9. Close the broiler door. Press the "OFF" pad.

10. Remove control knobs. Reinstall the control panel. Securely tighten the 4 screws. Reinstall the control knobs. **Important:** If not done in Step 8, check the "LO" flame adjustment. See "Check operation" section, Step 19, Page 7.

Moving the range:

! WARNING



Tip Over Hazard

A child or adult can tip the range and be killed.

Connect anti-tip bracket to rear range foot.

Reconnect the anti-tip bracket, if the range is moved.

Failure to follow these instructions can result in death or serious burns to children and adults.

When moving range, slide range onto cardboard or hardboard to prevent damaging the floor covering.

If removing the range is necessary for cleaning or maintenance:

1. Shut off the gas supply to the range.
2. Disconnect gas.
3. Unplug range or disconnect power.
4. Slide range forward to complete cleaning or maintenance.

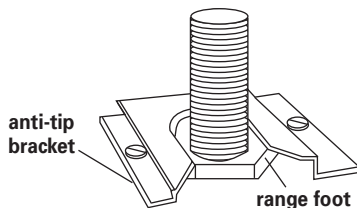

5. Making sure the anti-tip bracket is installed:

- Look for the anti-tip bracket securely attached to floor.
- Slide range back so rear range foot is under anti-tip bracket.

6. Check that range is level.
7. Reconnect gas line to range and check for leaks.
8. Plug in range or reconnect power.

For cleaning and maintenance...

If removing the range is necessary for cleaning or maintenance, disconnect the electric supply.

If electrical supply is inaccessible, lift the range slightly at the front and pull the range away from the wall. Pull the range out only as far as necessary to disconnect the electrical supply line.

Remove the range to complete cleaning or maintenance.

Move range back into operating position. Remove drawer. Level the range. Reconnect the electrical supply. Make sure that left rear leveling leg is engaged in the anti-tip bracket.

If range does not operate:

- Check that the circuit breaker is not tripped or the house fuse blown.
- Check that the power supply cord is plugged into the outlet.
- Check that gas line is turned on.
- See Use and Care Guide for troubleshooting list.

Note: Refer to Use and Care Guide for operating and cleaning instructions.

If you need assistance:

If you have questions about operating, cleaning or maintaining your range:

- Refer to **Use and Care Guide**.
- Call the Customer Interaction Center. Check your Use and Care Guide for a toll-free number to call or call the dealer from whom you purchased this appliance. The dealer is listed in the Yellow Pages of your phone directory under "Appliances — Household — Major — Service and Repair."

If you need service:

Maintain the quality built into your range by calling an authorized service company.

To obtain the name and number of the authorized service company:

- Contact the dealer from whom you purchased your range; or
- Look in the Yellow Pages of your telephone directory under "Appliances — Household — Major — Service and Repair;" or
- Call the Customer Interaction Center. The toll-free number is listed in your Use and Care Guide.

When you call, you will need:

- The range model number.
- The range serial number.

Both numbers are listed on the model/serial rating plate located on the frame behind the broiler door.

