

Use and Care Guide

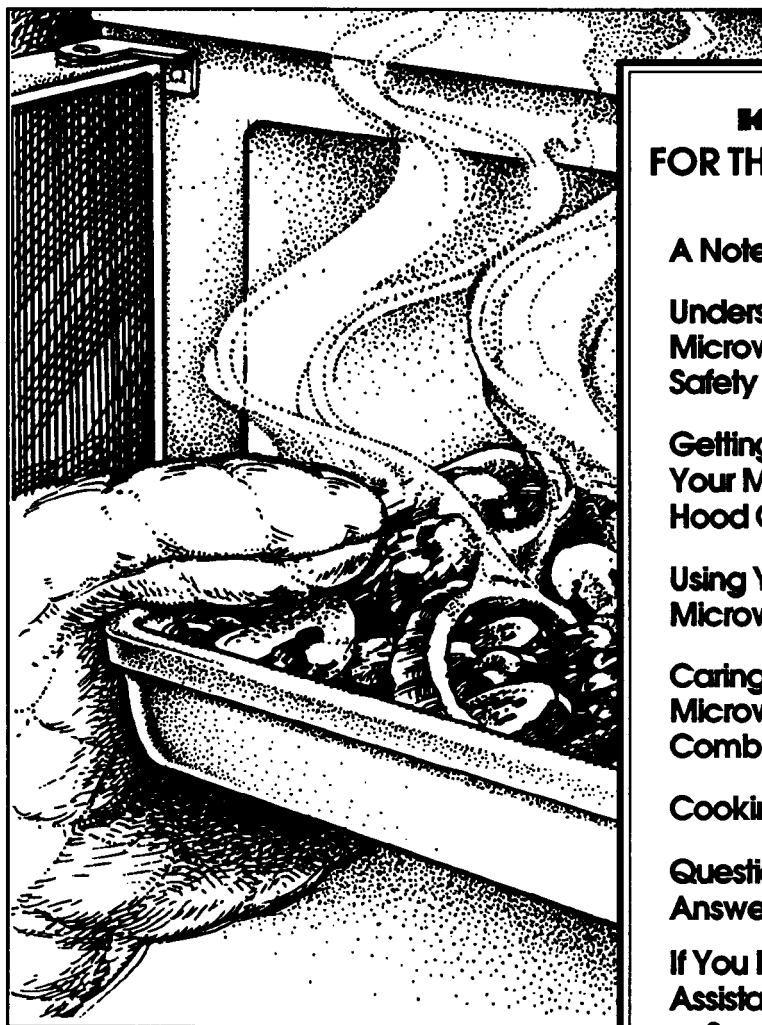

KitchenAid® **FOR THE WAY IT'S MADE.™**

A Note to You 2

Understanding
Microwave Oven
Safety 3

Getting to Know
Your Microwave
Hood Combination 8

Using Your
Microwave Oven 20

Caring for Your
Microwave Hood
Combination 48

Cooking Guide 52

Questions and
Answers 56

If You Need
Assistance
or Service 57

Warranty 60

1-800-422-1230

Call with questions or comments.

**KITCHENAID® Microwave Hood
Combination**

Model: KHMS105B

12/94

A Note to You

Thank you!

Thank you for buying a KitchenAid appliance. You have purchased a quality, *world-class* product. Years of engineering experience went into its manufacturing. To ensure that you enjoy many years of trouble-free operation, we developed this Use and Care Guide. It is full of valuable information on how to operate and maintain your appliance properly and safely. Please read it carefully. Also, please complete and mail the Ownership Registration Card provided with your new appliance.

Your safety is important to us.

This guide contains safety symbols and statements. Please pay special attention to these symbols and follow any instructions given. Here is a brief explanation of the use of each symbol.

WARNING

This symbol will help alert you to such dangers as personal injury, burns, fire and electrical shock.

CAUTION

This symbol will help you avoid actions which could cause product damage (scratches, dents, etc.) and damage to your personal property.

Our Consumer Assistance Center telephone number, 1-800-422-1230, is toll-free 24 hours a day.

If you ever have a question concerning your home appliance's operation, or if you need service, first see "If You Need Assistance or Service" on page 57. If you need further help, feel free to call our toll-free Consumer Assistance Center telephone number. When calling, you will need to know your appliance's complete model number and serial number. You can find this information on the model and serial number plate (see diagram on page 10). For your convenience, we have included a handy place below for you to record these numbers, as well as purchase information. You will need this information if you ever require service. Keep this book and the sales slip together in a safe place for future reference.

NOTE: You must provide proof of purchase or installation date for in-warranty service.

Model Number _____

Builder/Dealer Name _____

Serial Number _____

Address _____

Date Installed _____

Phone _____

Understanding Microwave Oven Safety

IMPORTANT SAFETY INSTRUCTIONS

Microwave ovens have been thoroughly tested for safe and efficient operation. However, as with any appliance, there are special installation and safety precautions which must be followed to ensure safe and satisfactory operation and prevent damage to the unit.

⚠ WARNING

To reduce the risk of burns, fire, electrical shock, injury to persons, exposure to excessive microwave energy, or damage when using the microwave oven, follow basic precautions, including the following:

- Read all instructions before using the microwave oven.
- Read and follow the specific "PRECAUTIONS TO AVOID POSSIBLE EXPOSURE TO EXCESSIVE MICROWAVE ENERGY" found on page 5.
- This appliance must be grounded. Connect only to properly grounded outlet. See "GROUNDING INSTRUCTIONS" found in the Installation Instructions.
- Install or locate this appliance only in accordance with the provided Installation Instructions.
- Some products such as whole eggs in the shell and sealed containers—for example, closed glass jars—could explode and should not be heated in this oven.
- Do not heat, store or use flammable materials in or near the oven. Fumes could create a fire hazard or explosion.
- Use this appliance only for its intended use as described in this manual. Do not use corrosive chemicals or vapors in this appliance. This type of oven is specifically designed to heat or cook food. It is not designed for industrial or laboratory use.
- As with any appliance, close supervision is necessary when used by children.
- Do not operate this appliance if it is not working properly, or if it has been damaged. Electrical shock, fire or other hazards could result.
- This appliance should be serviced only by qualified service personnel. Call an authorized KitchenAid servicer for examination, repair or adjustment.
- Do not cover or block any opening on the appliance. Fire could result.
- Do not store this appliance outdoors. Do not use this product near water—for example, near a kitchen sink, in a wet basement, or near a swimming pool, and the like.
- Do not immerse cord or plug in water.
- Keep cord away from heated surfaces.
- Do not let cord hang over edge of table or counter.
- This appliance is suitable for use above both gas and electric cooking equipment 36 inches or less wide.
- See door surface and interior cleaning instructions on page 48.
- To reduce the risk of fire in the oven cavity:
 - Do not overcook food. Carefully attend appliance if paper, plastic, or other combustible materials are placed inside the oven to facilitate cooking. Paper could char or burn, and some plastics could melt if used when heating foods.
 - Do not deep fry in oven. Microwavable utensils are not suitable and it is difficult to maintain appropriate deep frying temperatures.

continued on next page

Understanding Microwave Oven Safety

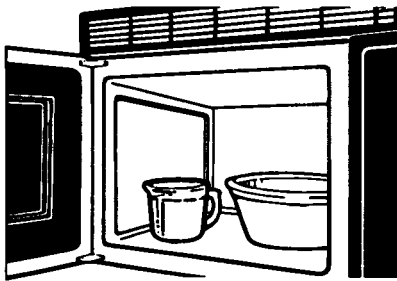

To reduce the risk of fire in the oven cavity (continued):

- **Test dinnerware or cookware before using.** To test a dish for safe use, put it into the oven with a cup of water beside it. Cook at 100% Cook Power for one minute. **If the dish gets hot and water stays cool, do not use it.** Some dishes (melamine, some ceramic dinnerware, etc.) absorb microwave energy, becoming too hot to handle and slowing cooking times. Cooking in metal containers not designed for microwave use could damage the oven, as can containers with hidden metal (twist-ties, foil lining, staples, metallic glaze or trim).
- Remove wire twist-ties from paper or plastic bags before placing bag in oven.

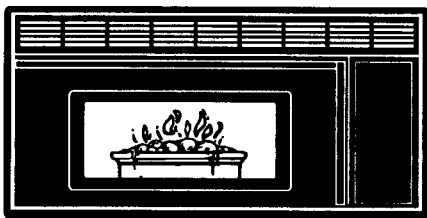

- If materials inside the oven should ignite, keep oven door closed, turn oven off, and disconnect the power cord or shut off power at the fuse or circuit breaker panel.

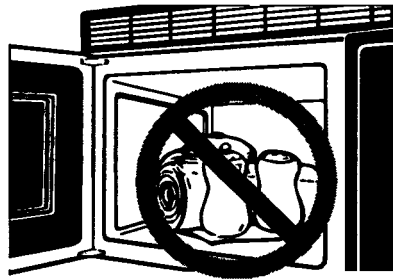

- Do not use the cavity for storage purposes. Do not leave paper products, cooking utensils, or food in the cavity when not in use.
- Because of the automatic exhaust fan feature, the following cautions must be observed:
 - Do not leave the area when using your cooktop at a high setting. Accidental fires from boilovers or spattering on the surface unit could spread, especially if the exhaust fan is operating.
 - Do not allow grease and soil to build up in the grease filter. Exhaust fan efficiency will decrease and fire could result. Clean often following the filter cleaning instructions on page 49.
 - Do not change the cooktop or oven lights without turning the power off at the main power supply (see page 50). Electrical shock could result.
 - Do not flame foods on a cooktop surface below this unit. The fan, if operating, could spread the flame and cause personal injury or property damage.
- Use care when cleaning the vent hood filter. Corrosive cleaning agents, such as lye-based oven cleaners, could damage filter.
- Read and follow "Operating safety precautions" starting on page 6.

1. A short power-supply cord is provided to reduce the risks resulting from becoming entangled in or tripping over a longer cord.
2. Longer cord sets or extension cords are available and may be used if care is exercised in their use.
3. If a long cord or extension cord is used temporarily, (a) the marked electrical rating of the cord set or extension cord should be at least as great as the electrical rating of the appliance, (b) the extension cord must be a grounding-type, 3-wire cord that has a 3-blade grounding plug and a 3-slot receptacle that will accept the plug on the appliance, and (c) the longer cord should be arranged so that it will not drape over the countertop or tabletop where it can be pulled on by children or tripped over accidentally.
4. A qualified electrician must install a properly grounded and polarized 3-prong receptacle near the appliance.

– SAVE THESE INSTRUCTIONS –

PRECAUTIONS TO AVOID POSSIBLE EXPOSURE TO EXCESSIVE MICROWAVE ENERGY...

Do not attempt to operate this oven with the door open since open-door operation can result in harmful exposure to microwave energy. It is important not to defeat or tamper with the safety interlocks.

Do not place any object between the oven front face and the door or allow soil or cleaner residue to accumulate on sealing surfaces.

Do not operate the oven if it is damaged. It is particularly important that the oven door close properly and that there is no damage to the:

- (1) Door (bent),
- (2) Hinges and latches (broken or loosened),
- (3) Door seals and sealing surfaces.

Do not operate the microwave oven if the door window is broken.

The microwave oven should be checked for microwave leakage by qualified service personnel after a repair is made.

The oven should not be adjusted or repaired by anyone except properly qualified service personnel.

Do not operate the microwave oven with the outer cabinet removed.

Operating safety precautions

⚠ WARNING

To reduce the risk of burns, fire, electrical shock, injury to persons, or damage when using the microwave oven, follow the precautions on pages 6-7.

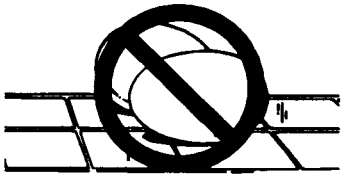

Never cook or reheat a whole egg inside the shell. Steam buildup in whole eggs may cause them to burst and burn you, and possibly damage the oven. **Slice** hard-boiled eggs before heating. In rare instances, poached eggs have been known to explode. **Cover** poached eggs and **allow** a standing time of one minute before cutting into them.



Stir before heating

For best results, stir any liquid several times before heating or reheating. Liquids heated in certain containers (especially cylindrical containers) may become overheated. The liquid may splash out with a loud noise during or after heating or when adding ingredients (coffee, etc.) resulting in harm to the oven and possible personal injury.

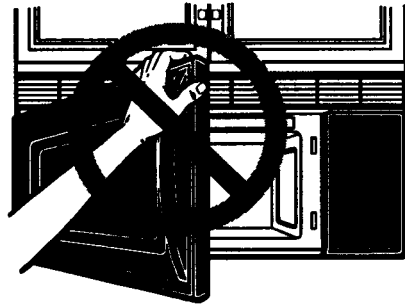

Never lean on the door or allow a child to swing on it when the door is open. Injury could result.

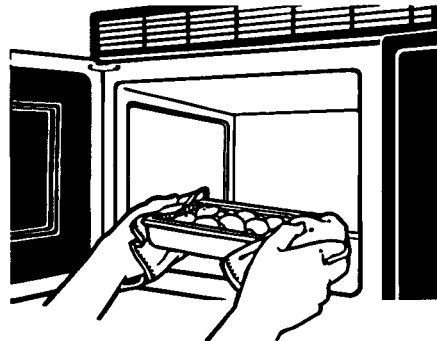

Use hot pads. Microwave energy does not heat containers, but the hot food does.

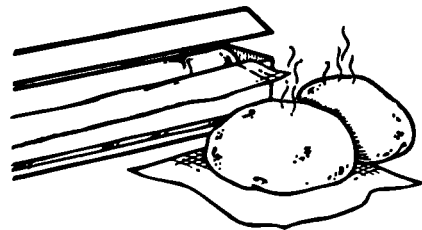

Do not overcook potatoes. Fire could result. At the end of the recommended cooking time, potatoes should be slightly firm because they will continue cooking during standing time. **After microwaving, wrap potatoes in foil and set aside for 5 minutes.** They will finish cooking while standing.

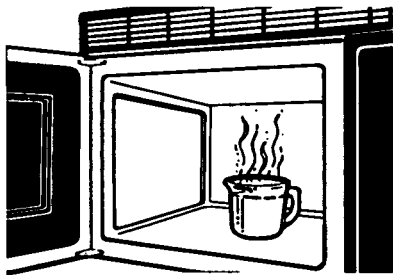

Do not start a microwave oven when it is empty. Product life may be shortened.

If you practice programming the oven, put a container of water in the oven.

It is normal for the inside of the oven door to look wavy after the oven has been running for a while.



Do not try to melt paraffin wax in the oven. Paraffin wax will not melt in a microwave oven because it allows microwaves to pass through it.

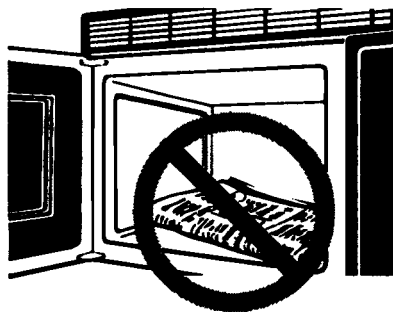

Do not use newspaper or other printed paper in the oven. Fire could result.

Do not dry flowers, fruit, herbs, wood, paper, gourds or clothes in the oven. Fire could result.

General information

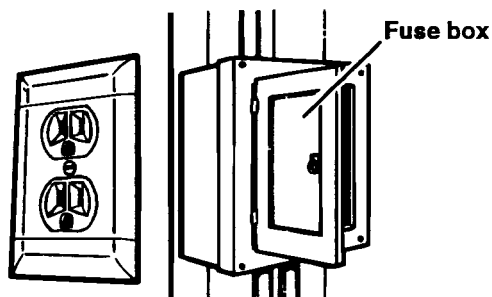

If your electrical power line or outlet voltage is less than 110 volts, cooking times may be longer. Have a qualified electrician check your electrical system.

Getting to Know Your Microwave Hood Combination

This section discusses the concepts behind microwave cooking and introduces you to the basics you need to know to operate your microwave oven. Please read this information before use.

IN THIS SECTION

How microwave cooking works 8

Microwave oven features 10

Control panel features 11

Using the exhaust fan 14

Using the cooktop/countertop light 15

Using the bi-level cooking rack 17

Setting the clock 18

Using the Minute Timer 19

How microwave cooking works

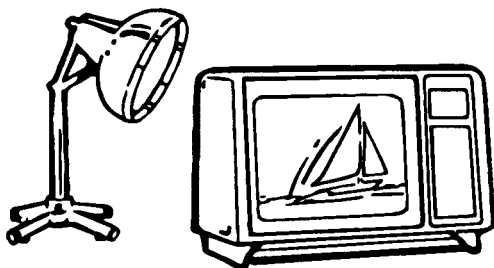

Microwave ovens are safe. Microwave energy is not hot. It causes food to make its own heat, and it's this heat that cooks the food.

Microwaves are like TV waves or light waves. You cannot see them, but you can see what they do.

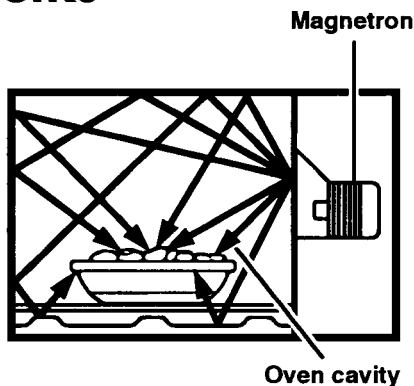

A magnetron in the microwave oven produces microwaves. The microwaves move into the oven where they contact the food.

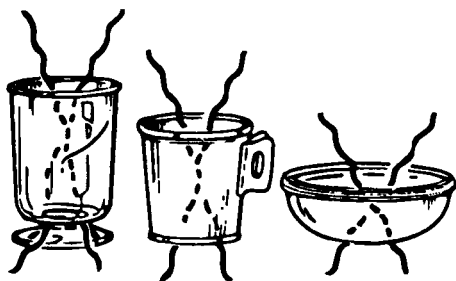

Microwaves pass through most glass, paper and plastics without heating them so food absorbs the energy. Microwaves bounce off metal pans so food does not absorb the energy.

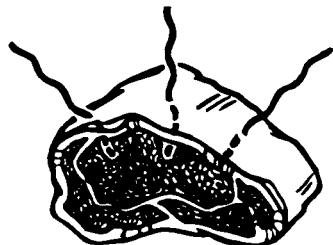

Microwaves may not reach the center of a roast. The heat spreads to the center from the outer, cooked areas just as in conventional cooking. This is one of the reasons for letting some foods (for example, roasts or baked potatoes) stand for a while after cooking, or for stirring some foods during the cooking time.

The microwaves disturb water molecules in the food. As the molecules bounce around bumping into each other, heat is made, like rubbing your hands together. This is the heat that does the cooking.

Radio interference

Operation of the microwave oven may cause interference to your radio, TV or similar equipment. When there is interference, it may be reduced or eliminated by taking the following measures:

- **Clean** door and sealing surfaces of the oven.
- **Adjust** the receiving antenna of radio or television.
- **Move** the receiver away from the microwave oven.
- **Plug** the microwave oven into a different outlet so that the microwave oven and receiver are on different branch circuits.

Microwave oven features

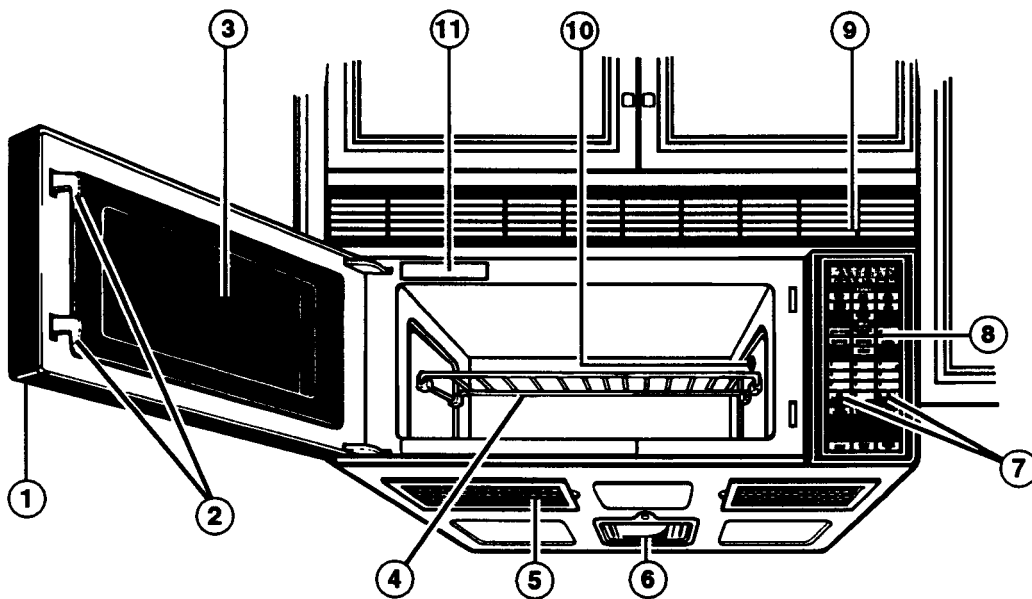

Your microwave oven is designed to make your cooking experience as enjoyable and productive as possible. To get you up and running quickly, the following is a list of the oven's basic features:

- 1. Door Handle.** Pull to open door.
- 2. Door Safety Lock System.** The oven will not operate unless the door is securely closed.
- 3. Window with Metal Shield.** Shield prevents microwaves from escaping. It is designed as a screen to allow you to view food as it cooks.
- 4. Two-Position Bi-Level Cooking Rack.** Use for extra space when cooking in more than one container at the same time. See page 17 for more information.
- 5. Filter.** See page 49 for cleaning information.
- 6. Cooktop/Countertop Light.** Turn on to light your cooktop or countertop or turn on as a night light. See page 15 for more information.
- 7. Exhaust Fan and Cooktop Light Switches.** See pages 14-17 for more information.
- 8. Control Panel.** Touch the pads on this panel to perform all functions. See pages 11-13 for more information.
- 9. Vent Grille.**
- 10. Temperature Probe Socket** (on oven wall). Plug the Temperature Probe into this socket when using probe for cooking. See page 31 for more information.
NOTE: Do not store the Temperature Probe in the oven when probe is not being used. Store in a handy place.
- 11. Model and Serial Number Plate.**

Smoke deflector accessory kit

A smoke deflector kit for your model is available from your KitchenAid parts dealer to use when installing this microwave oven over cooking products with a grill or griddle. Ask your KitchenAid dealer for details on Kit No. 4358523 – Smoke Deflector Kit.

Control panel features

Your microwave oven control panel lets you select the desired cooking function quickly and easily. All you have to do is touch the necessary Command Pad. Below are descriptions of some basic functions you should know about. These descriptions are followed, on the next page, by a list of all the Command and Number Pads located on the control panel. For more information, see pages 14-47.

Using the demonstration feature

You can set your microwave oven to demonstrate its functions without turning the oven on.

NOTE: This feature can only be used when the microwave oven is first connected to power. You cannot use the demonstration feature after a Command Pad has been touched.

To set the demo feature:

1. **Open** the door and **keep** it open.
2. **Touch and hold** DELAY START for four seconds. Three tones, followed by two tones, will sound.
3. **Release** DELAY START.
4. **Shut** the door to start the demo.

To cancel the demo feature:

Touch CANCEL/OFF.

Audible signals

Audible signals are available to guide you when setting and using your oven:

- **A programming tone will sound** each time you touch a pad.
- **One long tone** signals the end of a Minute Timer countdown.
- **Four tones** signal the end of a cooking cycle.
- **Two tones** sound once every minute after an End-of-Cooking signal as a reminder if food has not been removed from oven.
- **Three tones** sound if you have made an incorrect entry.

To disable audible signals:

- **Touch and hold** Number Pad 1 for four seconds to disable programming tones.

OR

- **Touch and hold** Number Pad 2 for four seconds to disable all signals.

To turn signals back on:

Repeat steps under “To disable audible signals” above.

NOTE: Three tones, followed by two tones, will sound when audible signals are turned on or off.

Interrupting cooking

You can stop the oven during a cycle by opening the door.

The oven stops heating and the fan stops, but the light stays on. **To restart cooking, close** the door and

TOUCH

START

If you do not want to continue cooking:

- **Close** the door and the light goes off.

OR

• TOUCH

**CANCEL
OFF**

Using the safety lock

The safety lock prevents unwanted use of the microwave oven by disabling the control panel Command Pads.

To lock or deactivate the control panel:

Touch and hold Number Pad 3 for four seconds. Three tones, followed by two tones, will sound and  will appear on the Display.

To cancel the safety lock:

Touch and hold Number Pad 3 for four seconds. Three tones, followed by two tones, will sound and  will be cleared from the Display.

Getting to Know Your Microwave Hood Combination

1. **Display.** The Display includes a clock and indicators to tell you time of day, cooking time settings and cooking functions selected.
2. **MICRO COOK.** Touch this pad followed by Number Pads to set a cooking time. See pages 21, 23, and 24 for more information.
3. **COOK POWER.** Touch this pad followed by a Number Pad to set the amount of microwave energy released to cook the food. The higher the number, the higher the microwave power or “cooking speed.” See page 22 for more information. See the “Microwave cooking chart” on page 53 for specific Cook Powers to use for the foods you are cooking.
4. **EASY MINUTE.** Touch this pad to cook for one minute, at 100% Cook Power, or to add an extra minute, at the set Cook Power, to your cooking cycle. See page 46 for more information.
5. **CUSTOM DEFROST.** Touch this pad followed by Number Pads to thaw frozen meat by weight. See page 25 for more information.
6. **TEMP PROBE.** Touch this pad when using the Temperature Probe to cook. Touch TEMP PROBE followed by Number Pads to set desired final food temperature. See page 31 for more information.
7. **KEEP WARM.** Touch this pad to keep hot, cooked foods safely warm in your microwave oven for up to 99 minutes, 99 seconds. KEEP WARM can be used by itself, or it can automatically follow a cooking cycle. See page 30 for more information.
8. **FAVORITE RECIPE.** Touch this pad to recall one cooking instruction previously programmed into memory. See page 38 for more information.
9. **AUTO COOK.** Touch this pad to cook at a preset Cook Power. The oven’s sensor will tell the oven how long to cook

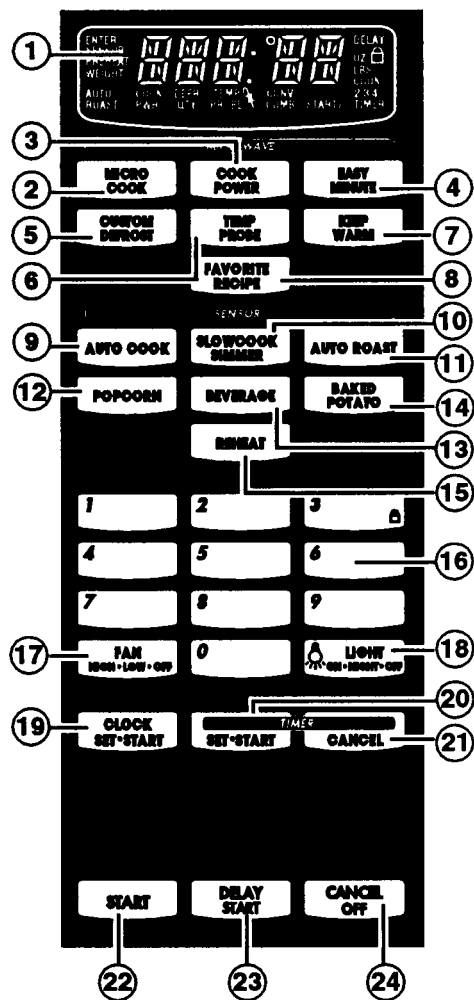

depending on the amount of vapor it detects from the food. See page 40 for more information.

10. **SLOWCOOK/SIMMER.** Touch this pad to stew or simmer food. The oven’s sensor will tell the oven how long to cook depending on the amount of vapor it detects from the food. See page 45 for more information.
11. **AUTO ROAST.** Touch this pad to roast with the Temperature Probe. See page 34 for more information.
12. **POPCORN.** Touch this pad to pop popcorn at a preset Cook Power.

The oven's sensor will tell the oven how long to cook depending on the amount of vapor it detects from the popcorn. See page 43 for more information.

13. **BEVERAGE.** Touch this pad to reheat a cup of a beverage at a preset Cook Power. The oven's sensor will tell the oven how long to heat depending on the amount of vapor it detects from the beverage. See page 41 for more information.
14. **BAKED POTATO.** Touch this pad to bake a potato at a preset Cook Power. The oven's sensor will tell the oven how long to heat depending on the amount of vapor it detects from the potato. See page 44 for more information.
15. **REHEAT.** Touch this pad to reheat food at a preset Cook Power. The oven's sensor will tell the oven how long to heat depending on the amount of vapor it detects from the food. See page 42 for more information.
16. **Number Pads.** Touch Number Pads to enter cooking times, Cook Powers, temperatures, weights or food categories.
17. **FAN.** Touch this pad once to turn on the fan at high speed, twice to turn on the fan at low speed, and three times to turn the fan off. See page 14 for more information.
18. **LIGHT.** Touch this pad once to turn the cooktop/countertop light on at high power, twice to turn the cooktop/countertop light on at low power as a night light, and three times to turn the cooktop/countertop light off. See page 15 for more information.
19. **CLOCK SET•START.** Touch this pad to enter the correct time of day. See page 18 for more information.
20. **TIMER SET•START.** Touch this pad to set the Minute Timer. See page 19 for more information.
21. **TIMER CANCEL.** Touch this pad to cancel the Minute Timer. See page 19 for more information.
22. **START.** Touch this pad to start a function. If you open the door after the oven begins to cook, retouch START. See below for more information.
23. **DELAY START.** Touch this pad to program your oven to begin cooking automatically at a chosen time later in the day. See page 36 for more information.
24. **CANCEL/OFF.** Touch this pad to erase an incorrect command, cancel a program during cooking, or to clear the Display. See page 11 for more information.

Using the exhaust fan

1. Choose fan speed.

NOTE: If the temperature gets too hot around the microwave oven, the exhaust fan in the vent hood will automatically turn on at the LOW setting to protect the oven. It may stay on up to an hour to cool the oven. When this occurs, the Fan Pad will not turn the fan off.

TOUCH



once for high, twice for low

2. Turn off fan when desired.

TOUCH



three times

To set fan to run for a specific time:

1. Start fan.

TOUCH



once for high, twice for low

2. Choose timer.

NOTE: If both the fan and light are operating and the TIMER SET•START Pad is touched twice, both the fan and light will be controlled by the timer. The Display will alternate between "FAN" and "LIGHT" one time before "TIME" is displayed.

TOUCH



twice within
3 seconds

YOU SEE



3. Set time.

Example for 5 minutes:

TOUCH

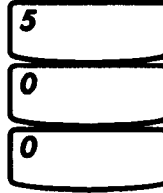

YOU SEE



4. Start timer.

TOUCH



YOU SEE



At end of time:

YOU SEE



To cancel timer:

NOTE: Canceling the timer will cause the fan to shut off; however, canceling the fan will not cancel the timer.

TOUCH



Using the cooktop/countertop light

1. Choose light.

TOUCH



once for high, twice for low

2. Turn off light when desired.

TOUCH



three times

To set light to be on for a specific time:

1. Turn on light.

TOUCH



once for high, twice for low

2. Choose timer.

NOTE: If both the fan and light are operating and the TIMER SET • START Pad is touched twice, both the fan and light will be controlled by the timer. The Display will alternate between "FAN" and "LIGHT" one time before "TIME" is displayed.

TOUCH



twice within
3 seconds

YOU SEE



3. Set time.

Example for 20 minutes:

TOUCH

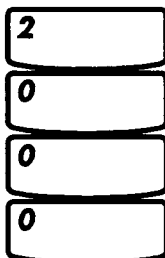

YOU SEE



4. Start timer.

TOUCH



YOU SEE



At end of time:

YOU SEE



To cancel timer:

TOUCH



NOTE: Canceling the timer will cause the light to shut off; however, canceling the light will not cancel the timer.

Using the bi-level cooking rack

The Bi-Level Cooking Rack (Part No. 4358524) gives you extra space when cooking in more than one container at the same time. The metal rack can be turned upside-down to help fit taller containers on the bottom of the oven.

If you need a replacement rack and your KitchenAid dealer does not stock the rack, you can order it, by part number, by writing to:

KitchenAid
Parts Distribution Center
123 Koomler Drive
LaPorte, IN 46350

Inserting the rack

First position

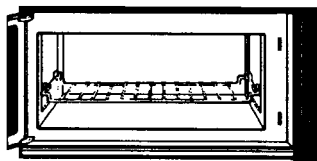

First position: Insert the rack securely into the rack supports on the side walls of the oven.

Second position



Second position: Turn rack upside-down when using a taller container on the bottom of the oven.

WARNING

Personal Injury and Product Damage Hazard

- Use hot pads when removing rack from oven after cooking to prevent burns. Rack may be hot.
- Do not store the metal rack in the oven. Arcing and damage to the oven could result if someone accidentally starts the oven.
- Do not operate the oven with the metal rack stored on the floor of the oven. Damage to the interior finish will result.
- Use rack only in the microwave oven.
- Do not use rack with browning dish.
- Do not let food container on rack touch the top or sides of the oven.
- Do not cook foods directly on rack without putting them in containers first.
- Do not place a metal cooking container on rack. Place a microwave-safe plate under container.

Setting the clock

When your microwave oven is first plugged in or after a power failure, the Display will show "888:88". For the first 30 seconds after the power is on, you can set the clock time without touching CLOCK SET • START. After 30 seconds have gone by, you must follow the directions below to set the time. If a time of day is not set, "888:88" will show in the Display until you touch CLOCK SET • START.

NOTES:

- **You can** only set the clock if the oven is not cooking food.
- **If you touch in** an incorrect time and touch CLOCK SET • START, three tones will sound. Enter the correct time.
- **If you touch** CANCEL/OFF while setting the clock, the Display will show the last time of day set or ":" if no time of day has been set.

To set time:

1. Choose setting.

TOUCH



YOU SEE



2. Enter time of day.

Example for 12:00:

TOUCH

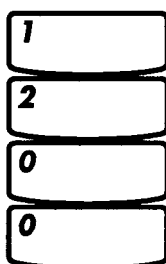

YOU SEE



3. Complete entry.

TOUCH



OR



YOU SEE



Using the Minute Timer

You can use your microwave oven as a minute timer. Use the Minute Timer for timing up to 99 minutes, 99 seconds.

NOTE: The oven can operate while the Minute Timer is in use. To see the Minute Timer while the oven is cooking, touch **TIMER SET • START**. The Display will return to the cooking time countdown after 3 seconds.

1. Touch **TIMER SET • START**.

TOUCH



YOU SEE



2. Enter time to be counted down.

Example for 1 minute, 30 seconds:

NOTE: If you enter more than 4 digits, three tones will sound. Touch **START** to count down the 3-digit time you have entered or touch **CANCEL/OFF** to clear the Display. To start over, touch **TIMER SET • START** and reenter desired time.

TOUCH

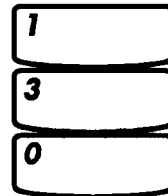

YOU SEE



3. Start countdown.

NOTE: If you do not do this step within three seconds of doing Step 2, "START?" will be displayed. You then have one minute to touch **START** or **TIMER SET • START** before the Display returns to time of day.

TOUCH



OR



YOU SEE

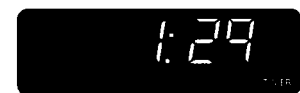

At end of countdown:

YOU SEE



(one tone will sound)

To cancel Minute Timer:

During countdown:

TOUCH



YOU SEE



(time of day)

After countdown:



Using Your Microwave Oven

This section gives you instructions for operating each function. Please read these instructions carefully.

IN THIS SECTION

Getting the best cooking results ...	20	Using DELAY START	36
Cooking at high cook power	21	Using FAVORITE RECIPE	38
Cooking at lower cook powers	22	Using AUTO COOK	40
Cooking with more than one cook cycle	24	Auto cook chart	41
Using CUSTOM DEFROST	25	Using BEVERAGE	41
Custom defrost chart	27	Using REHEAT	42
Defrosting tips	29	Using POPCORN	43
Using KEEP WARM	30	Using BAKED POTATO	44
Cooking with the temperature probe	31	Using SLOWCOOK/SIMMER	45
Using AUTO ROAST	34	Using EASY MINUTE	46
Auto roast chart	35	Adding or subtracting cook time ...	47

Getting the best cooking results

- **Although a new rating method*** rates this oven at 850 watts, you may use a reliable cookbook and recipes developed for microwave ovens previously rated at 700-800 watts.
- **ALWAYS cook** food for the minimum recommended cooking time. If necessary, touch EASY MINUTE while the oven is operating or after it has completed the cooking cycle (see page 46 for more information). Then check for doneness to avoid overcooking the food.
- **Stir, turn over or rearrange food** being cooked about halfway through the cook time for most even doneness with all recipes.
- **If a glass cover is not available, use wax paper, paper towels or microwave-approved plastic wrap.** Turn back a corner to vent steam during cooking.

*IEC-705 Test Procedure. The IEC-705 Test Procedure is an internationally recognized method of rating microwave wattage output and does not represent an actual change to output power or cooking performance.

Cooking at high cook power

1. Put food in oven and close the door.

2. Set cooking time.

TOUCH



YOU SEE



Example for 1 minute,
30 seconds:

TOUCH

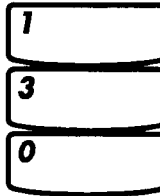

YOU SEE



3. Start oven.

TOUCH



YOU SEE



At end of cooking time:

YOU SEE

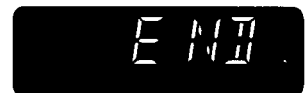

Changing instructions

You can change the cooking time after cooking starts by repeating Step 2.

Cooking at lower cook powers

For best results, some recipes call for lower Cook Powers. The lower the Cook Power, the slower the cooking. Each Number Pad also stands for a different percentage of Cook Power. Many microwave cookbook recipes tell you by number, percent or name which Cook Power to use.

The following chart gives the percentage of Cook Power each Number Pad stands for, and the Cook Power name usually used. It also tells you when to use each Cook Power.

COOK POWER	NAME	WHEN TO USE IT
Automatic 100% of full power	HIGH	Quick reheating of foods with high water content, such as beverages. If food contains eggs or cream, choose a lower power.
9=90% of full power		Heating large quantities of liquids, such as water or soup stock.
8=80% of full power		Reheating soups or casseroles.
7=70% of full power	MED-HIGH	Cooking and heating vegetables, fish, meat, etc. when you need a Cook Power lower than HIGH or when food is cooking too fast.
6=60% of full power		Cooking requiring special care, such as for high protein sauces, cheese and egg dishes, and casseroles that need to finish cooking.
5=50% of full power	MED	Starting cakes which must be finished on HIGH power or finishing cooking of a large roast.
4=40% of full power		Simmering stews, reheating pastries.
3=30% of full power	MED-LOW, DEFROST	Defrosting of foods such as bread, shellfish, and precooked foods.
2=20% of full power		Defrosting and softening butter, cheese and ice cream.
1=10% of full power	LOW	Keeping one food serving warm.

NOTE: You can also use the Cook Power pad as a second Minute Timer by entering "0" for the Cook Power. The oven will count down the cooking time you set without cooking.



1. Put food in oven and close the door.

2. Set cooking time.

TOUCH



YOU SEE



Example for 7 minutes, 30 seconds:

TOUCH

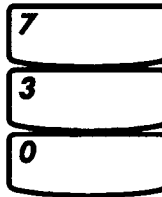

YOU SEE



3. Set Cook Power.

TOUCH



YOU SEE

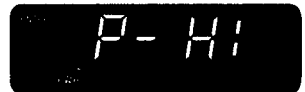

Example for 50% Cook Power:

TOUCH



YOU SEE



4. Start oven.

TOUCH



YOU SEE

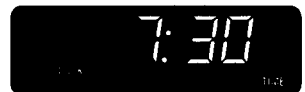

At end of cooking time.

YOU SEE



Changing instructions

You can change the cooking time or Cook Power after cooking starts by repeating Steps 2 and/or 3.

Cooking with more than one cook cycle

For best results, some recipes call for one Cook Power for a certain length of time, and another Cook Power for another length of time. Your oven can be set to change from one to another automatically, for up to two cycles.

1. Put food in oven and close the door.

2. Set cooking time for first cycle.

TOUCH



YOU SEE



Example for 7 minutes, 30 seconds:

TOUCH

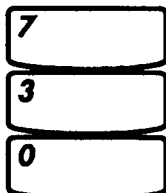

YOU SEE

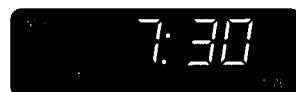

3. Set Cook Power for first cycle.

TOUCH



YOU SEE



Example for 50% Cook Power:

TOUCH



YOU SEE

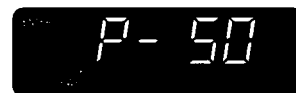

4. Repeat Steps 2 and 3 to set cooking time and Cook Power for the second cycle.

5. Start oven.

After the first cycle is over, the next cycle will count down.

TOUCH



YOU SEE



(first cycle)

At end of cooking time:

YOU SEE



Changing instructions

You can change times or Cook Powers for a cycle any time after that cycle starts by repeating Steps 2 and/or 3.

Using CUSTOM DEFROST

Your microwave oven automatically defrosts a variety of common meats at preset Cook Powers for preset times. The 2-stage defrost cycle is programmed for meat, poultry, and fish. All you do is touch the Command Pad assigned to the desired category and enter the weight of the items being defrosted. Your microwave oven does the rest.

NOTES:

- See the “Custom defrost chart” on page 27 for defrosting directions for each food.
- To defrost items not listed in “Custom defrost chart” on pages 27 and 28, use 30% Cook Power. Refer to a reliable cookbook for defrosting information.

1. Put frozen food in oven and close the door.

2. Choose CUSTOM DEFROST.

TOUCH



YOU SEE



3. Choose food category (1 for meat, 2 for poultry, 3 for fish).

Example for meat:

TOUCH



YOU SEE



Then:



4. Enter food's weight (in pounds and tenths of a pound).

Example for 1.2 lbs:

NOTES:

- For converting fractions of a pound to decimals, see "Weight conversion chart" on page 29.
- If you enter an incorrect weight, touch CUSTOM DEFROST again and enter the correct weight.

TOUCH



YOU SEE



5. Start oven.

TOUCH



YOU SEE



6. After half the cook time is over, Display will prompt you to turn over food.

Open door, turn over food, and shield any warm portions.

NOTE: If you do not open the door within two minutes, the Display will resume the countdown.

YOU SEE



7. Restart oven.

TOUCH



YOU SEE



(time remaining)

At end of defrosting time:

YOU SEE



Custom defrost chart

Meat setting

FOOD	AT PAUSE	SPECIAL INSTRUCTIONS
Beef		Meat of irregular shape and large, fatty cuts of meat should have the narrow or fatty areas shielded with foil at the beginning of a defrost cycle.
Ground Beef, Bulk	Remove thawed portions with fork. Turn over. Return remainder to oven.	Do not defrost less than 1/4 lb. Freeze in doughnut shape.
Ground Beef, Patties	Separate and rearrange.	Do not defrost less than two 4 oz patties. Depress center when freezing.
Round Steak	Turn over. Cover warm areas with aluminum foil.	Place on a microwavable roasting rack.
Tenderloin Steak	Turn over. Cover warm areas with aluminum foil.	Place on a microwavable roasting rack.
Stew Beef	Remove thawed portions with fork. Separate remainder. Return remainder to oven.	Place in a microwavable baking dish.
Pot Roast, Chuck Roast	Turn over. Cover warm areas with aluminum foil.	Place on a microwavable roasting rack.
Rib Roast	Turn over. Cover warm areas with aluminum foil.	Place on a microwavable roasting rack.
Rolled Rump Roast	Turn over. Cover warm areas with aluminum foil.	Place on a microwavable roasting rack.
Lamb		
Cubes for Stew	Remove thawed portions with fork. Return remainder to oven.	Place in a microwavable baking dish.
Chops (1 inch thick)	Separate and rearrange.	Place on a microwavable roasting rack.
Pork		
Chops (1/2 inch thick)	Separate and rearrange.	Place on a microwavable roasting rack.
Hot Dogs	Separate and rearrange.	Place on a microwavable roasting rack.
Spareribs, Country-Style Ribs	Turn over. Cover warm areas with aluminum foil.	Place on a microwavable roasting rack.
Sausage, Links	Separate and rearrange.	Place on a microwavable roasting rack.
Sausage, Bulk	Remove thawed portions with fork. Turn over. Return remainder to oven.	Place in a microwavable baking dish.
Loin Roast, Boneless	Turn over. Cover warm areas with aluminum foil.	Place on a microwavable roasting rack.

Custom defrost chart (continued)

Fish setting

FOOD	AT PAUSE	SPECIAL INSTRUCTIONS
Fish		
Fillets	Turn over. Separate fillets when partially thawed.	Place in a microwavable baking dish. Carefully separate fillets under cold water.
Steaks	Separate and rearrange.	Place in a microwavable baking dish. Run cold water over to finish defrosting.
Whole	Turn over.	Place in a microwavable baking dish. Cover head and tail with foil; do not let foil touch sides of microwave oven. Finish defrosting by immersing in cold water.
Shell Fish		
Crabmeat	Break apart. Turn over.	Place in a microwavable baking dish.
Lobster Tails	Turn over and rearrange.	Place in a microwavable baking dish.
Shrimp	Separate and rearrange.	Place in a microwavable baking dish.
Scallops	Separate and rearrange.	Place in a microwavable baking dish.

Poultry setting

FOOD	AT PAUSE	SPECIAL INSTRUCTIONS
Chicken		
Whole (up to 9½ lbs)	Turn over (finish defrosting breast-side down). Cover warm areas with aluminum foil.	Place chicken breast-side up on a microwavable roasting rack. Finish defrosting by immersing in cold water. Remove giblets when chicken is partially defrosted.
Cut Up	Separate pieces and rearrange.	Place on a microwavable roasting rack.
	Turn over. Cover warm areas with aluminum foil.	Finish defrosting by immersing in cold water.
Cornish Hens		
Whole	Turn over. Cover warm areas with aluminum foil.	Place on a microwavable roasting rack. Finish defrosting by immersing in cold water.
Turkey		
Breast (under 6 lbs)	Turn over. Cover warm areas with aluminum foil.	Place on a microwavable roasting rack. Finish defrosting by immersing in cold water.

Weight conversion chart

You are probably used to food weights as being in pounds and ounces that are fractions of a pound (for example 4 ounces equals $\frac{1}{4}$ pound). However, in order to enter food weight in CUSTOM DEFROST, you must specify pounds and tenths of a pound.

If the weight on the food package is in fractions of a pound, you can use the following chart to convert the weight to decimals.

NUMBER AFTER DECIMAL	EQUIVALENT OUNCE WEIGHT
.10	1.6
.20	3.2
.25 One-Quarter Pound	4.0
.30	4.8
.40	6.4
.50 One-Half Pound	8.0
.60	9.6
.70	11.2
.75 Three-Quarters Pound	12.0
.80	12.8
.90	14.4
1.00 One Pound	16.0

Defrosting tips

- **When using CUSTOM DEFROST**, the weight to be entered is the net weight in pounds and tenths of pounds (the weight of the food minus the container).
- **Only use CUSTOM DEFROST** for raw food. CUSTOM DEFROST gives best results when food to be thawed is a minimum of 0°F (taken directly from a “true” freezer). If food has been stored in a refrigerator-freezer that does not maintain a temperature of 0°F or below, always program a lower food weight (for a shorter defrosting time) to prevent cooking the food.
- **If the food is stored outside** the freezer for up to 20 minutes, enter a lower food weight.
- **If the food is stored outside** the freezer for more than 20 minutes, and for defrosting ready-made food, defrost by time and power and let stand after defrosting.
- **The shape of the package** alters the defrosting time. Shallow rectangular packets defrost more quickly than a deep block.
- **Separate pieces** as they begin to defrost. Separated pieces defrost more easily.
- **You can use small pieces** of aluminum foil to shield foods like chicken wings, leg tips, and fish tails, but the foil must not touch the side of the oven. Foil can damage the oven lining.
- **Shield areas of food** with small pieces of foil if they start to become warm.
- **For better results, a preset standing time** is included in the defrosting time. This may make the defrosting time seem longer than expected. (For more information on standing time, see “Microwave cooking tips” on page 54.)

Using KEEP WARM

You can safely keep hot, cooked food warm in your microwave oven for up to 99 minutes, 99 seconds (about 1 hour, 40 minutes). You can use KEEP WARM by itself, or to automatically follow a cooking cycle.

NOTES:

- **KEEP WARM** operates for up to 99 minutes, 99 seconds.
- **Opening** the oven door cancels KEEP WARM. Close the door and touch KEEP WARM, then touch START if additional KEEP WARM time is desired.
- **Food cooked covered** should be covered during KEEP WARM.
- **Pastry items** (pies, turnovers, etc.) should be uncovered during KEEP WARM.
- **Complete meals** kept warm on a dinner plate should be covered during KEEP WARM.
- **Do not use** more than one complete KEEP WARM cycle (about 1 hour, 40 minutes). The quality of some foods will suffer with extended time.

1. Put hot, cooked food in oven and close the door.

2. Choose setting.

TOUCH



YOU SEE



3. Start oven.

TOUCH



YOU SEE



To make KEEP WARM automatically follow another cycle:

- **While you are touching in cooking instructions, touch KEEP WARM** before touching START.
- **OR**
- **After the oven starts operating, touch CANCEL/OFF** once, touch KEEP WARM, and then touch START.
- **When the last cooking cycle is over, you will hear two tones.** "WARM" will come on while the oven continues to run.
- **You can set KEEP WARM to follow** CUSTOM DEFROST, COOK, temperature probe cooking, or multi-cycle cooking.

Cooking with the temperature probe

The Temperature Probe helps take the guesswork out of cooking roasts and larger casseroles. The probe is designed to turn off the oven when it senses the temperature you chose (between 90°F and 200°F). See your Cookbook for helpful information on cooking different types of food.

NOTE: If you have not plugged in the Temperature Probe properly or if probe is defective, "PROBE" will appear on the Display, three tones will sound, and the oven will not turn on. After correcting the problem or removing the probe, touch START to clear the Display.

1. Insert probe into food.

Insert at least $\frac{1}{3}$ of the Temperature Probe into the food. (See page 33.)

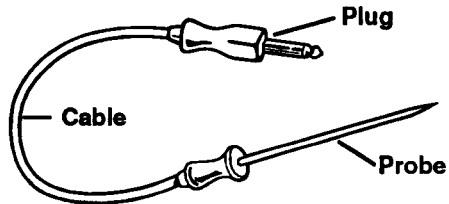

2. Place food in oven and plug probe into socket on oven wall.

Make sure the probe does not touch any part of the oven interior.

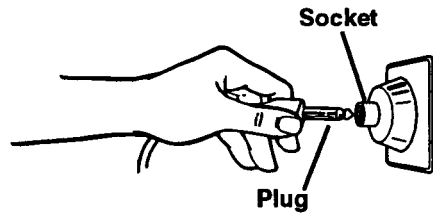

3. Close the door.

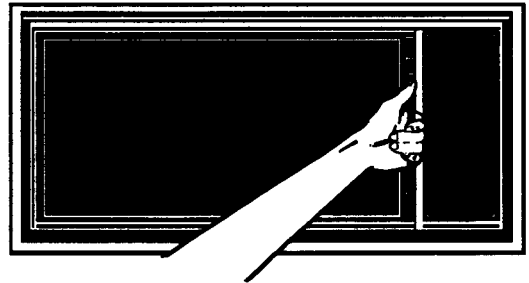

4. Choose setting.

NOTE: Food will automatically cook to 160°F if you do not specify a final food temperature. If you want to specify a final food temperature, do Step 5. Otherwise, skip to Step 6.

TOUCH



YOU SEE



5. Set desired final food temperature (optional).

Example for 180°:

TOUCH

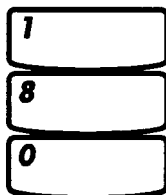

YOU SEE



6. Start oven.

TOUCH



YOU SEE



When food temperature reaches 90°F:
The displayed temperature will change each time food temperature increases by 5°F. If the temperature does not change after 20 minutes, the Display will show "CHECK" and "PROBE".

YOU SEE



When food reaches the desired temperature:

YOU SEE



To change final food temperature after oven has started:

1. Touch TEMP PROBE. You will see the current set temperature.
2. Reenter desired temperature.
3. Touch START.

NOTE: If you do not touch START within one minute after entering the new temperature, the oven will resume heating to the first temperature you set. You can ensure that your new temperature is set by touching TEMP PROBE (to display the set temperature for three seconds).

Temperature Probe cooking tips:

- **Stir** foods during cooking when recommended.
- **Stir** soups, casseroles and drinks before serving.
- **Cover** roasts with foil after cooking and **let stand** a few minutes. **Remove** foil if you decide to cook it longer.
- **Remove** the probe from the oven when not cooking by temperature.

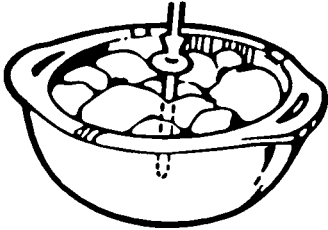

- **For casseroles**, the tip of the probe should be in the center of the food. **Stir** foods when recommended. **Replace** the probe.

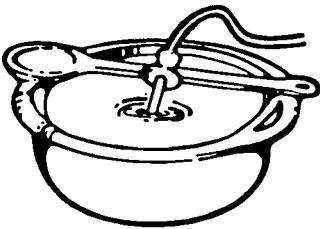

- **For liquids**, **balance** the probe on a wooden spoon or spatula so the tip of the probe is in the center of the liquid.

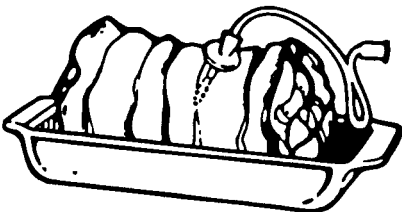

- **For roasts**, the tip of the probe should be in the center of the largest muscle, but not touching fat or bone.

- **Casseroles** cooked using the Temperature Probe should be made from precooked foods. **Do not use** raw meats, raw vegetables and cream sauces in casseroles.
- **Dry casseroles** do not work well.
- **Thaw** frozen casseroles and meats in the microwave oven before inserting the probe.
- **If you are cooking** more than one individual serving at the same time, such as mugs of soup, **check** the probe setting in several of the items—all the mugs may not heat at the same rate.
- **Dry meat loaf** mixtures do not work well.
- **Check** pork and poultry with thermometer in 2-3 places to ensure adequate doneness.
- **Roasts may vary** in size, shape and composition. **Use** the Temperature Probe as a guide.

Don't:

- **let probe or probe cable** touch any part of the oven interior.
- **let probe touch foil** (if used). You can keep foil away from probe with wooden toothpicks. **Remove** foil if arcing occurs.
- **use** paper, plastic wrap or plastic containers. They will be in the oven too long and might distort.
- **force** probe into frozen food.
- **use** probe for food that needs to simmer.
- **plug** the pointed end of the Temperature Probe into the socket.

Removing and cleaning the Temperature Probe:

1. After oven has shut off, **unplug** the Temperature Probe using an oven mitt or hot pad.
2. **Wipe** probe with a hot, sudsy cloth and **dry** thoroughly. **Use** a plastic scouring pad to remove cooked-on foods.
3. **You can place** probe in the silverware basket of a dishwasher.

Using AUTO ROAST

AUTO ROAST lets you roast food with the Temperature Probe, without needing to enter a final food temperature. The probe will turn off the oven when it senses the preprogrammed final food temperature for the food category you chose.

1. Perform Steps 1, 2, and 3 under “Cooking with the temperature probe” on page 31.

2. Choose setting.

TOUCH



YOU SEE



3. Choose food category.

See “Auto roast chart” on page 35 for categories.

Example for Category 1 (Roast Beef [rare]):

TOUCH

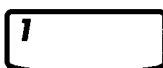

YOU SEE



4. Start oven.

TOUCH



YOU SEE



When food temperature reaches 90°F:

The displayed temperature will change each time food temperature increases by 5°F. If the temperature does not change after 20 minutes, the Display will show “CHECK” and “PROBE”.

YOU SEE



When food reaches the desired temperature:

YOU SEE



Auto roast chart

CATEGORY	FOOD	SPECIAL INSTRUCTIONS
1	Roast Beef (rare)	Put tip of probe in center of largest muscle, but not touching fat or bone. Shield top of roast with aluminum foil, sauce or vegetables. Cover roast with foil after cooking and let stand a few minutes.
2	Roast Beef (medium)	Put tip of probe in center of largest muscle, but not touching fat or bone. Shield top of roast with aluminum foil, sauce or vegetables. Cover roast with foil after cooking and let stand a few minutes.
3	Roast Beef (well)	Put tip of probe in center of largest muscle, but not touching fat or bone. Shield top of roast with aluminum foil, sauce or vegetables. Cover roast with foil after cooking and let stand a few minutes.
4	Roast Pork (well)	Put tip of probe in center of largest muscle, but not touching fat or bone. Shield top of roast with aluminum foil, sauce or vegetables. Cover roast with foil after cooking and let stand a few minutes.
5	Poultry	Shield the wing tips with aluminum foil. Check with thermometer in 2-3 places to ensure adequate doneness.
6	Casserole	Make casseroles from precooked foods. Position tip of probe in center of food. Stir before serving.
7	Simmer (liquid)	Balance probe on wooden spoon or spatula so tip of probe is in center of liquid. Stir before serving.

NOTE: Food to be roasted must be no less than .1 lb and no more than 9.9 lbs.

Using DELAY START

DELAY START lets you program your oven to begin cooking automatically at a time of day you choose. You can preprogram your oven up to 11 hours, 59 minutes in advance.

NOTES:

- **If you hear** the fan start when you touch START, you have not set the oven properly. Touch CANCEL/OFF and start over.
- **You cannot use** DELAY START with EASY MINUTE, CUSTOM DEFROST, POPCORN, BEVERAGE, REHEAT, AUTO ROAST, AUTO COOK, BAKED POTATO, or SLOW COOK/SIMMER.
- **Do not use** foods containing baking powder or yeast when using DELAY START. They will not rise properly.

WARNING

To avoid sickness and food waste when using DELAY START:

- Do not use foods that will spoil while waiting for cooking to start, such as dishes with milk or eggs, cream soups, and cooked meats or fish. Any food that has to wait for cooking to start should be very cold or frozen before it is put in the oven. **MOST UNFROZEN FOODS SHOULD NEVER STAND MORE THAN TWO HOURS BEFORE COOKING STARTS.**
- Do not allow food to remain in oven for more than two hours after end of cooking cycle.

1. Put food in oven and close door.

2. Make sure clock is set to correct time of day.

3. Choose setting.

TOUCH



YOU SEE



4. Set start time.

Example for 4:30:

TOUCH

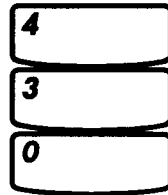

YOU SEE

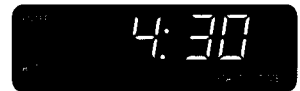

5. Enter cooking instructions for the function you want.

(cooking at high power or lower power, temperature probe cooking, KEEP WARM)

6. Complete entry.

TOUCH



YOU SEE



(time of day)

YOU SEE

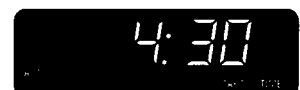

The oven will start cooking at the set time.

NOTE: If the door is opened before the start time is reached, the Display will show "DOOR" and "OPEN" for five minutes or until the door is closed, whichever comes first. You must touch START to resume DELAY START.

At end of cooking time:

YOU SEE



Using FAVORITE RECIPE

FAVORITE RECIPE allows you to recall one cooking instruction previously placed in memory and begin cooking quickly. For example, if you heat a roll every morning, program the cooking steps into FAVORITE RECIPE. You can heat your roll each morning by touching FAVORITE RECIPE.

FAVORITE RECIPE also allows you to program a function for another person to cook at a later time.

NOTE: You can reprogram FAVORITE RECIPE by repeating the instructions below. A power failure will erase your Favorite Recipe program.

To program FAVORITE RECIPE:

1. Choose FAVORITE RECIPE.

TOUCH



for 4 seconds

YOU SEE



2. Set cooking time.

TOUCH



YOU SEE

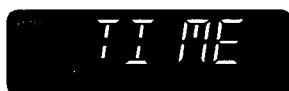

Example for 20 seconds:

TOUCH

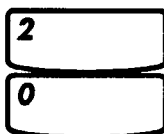

YOU SEE

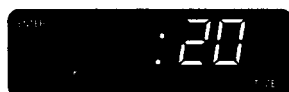

3. Set Cook Power.

TOUCH



YOU SEE



Example for 50% Cook Power:

TOUCH



YOU SEE



4. Complete entry.

TOUCH



YOU SEE



(time of day)

To use FAVORITE RECIPE:

1. Put food in oven and close door.

2. Choose FAVORITE RECIPE.

The oven will cook according to your preprogrammed instructions.

TOUCH

FAVORITE
RECIPE

YOU SEE

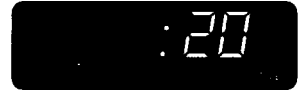

(display counts down programmed cooking time)

At end of cooking time:

YOU SEE



Using AUTO COOK

AUTO COOK lets you cook common microwave-prepared foods without needing to program times and Cook Powers. A sensor in your oven detects the vapor released by the food, and the amount of vapor detected tells the oven how long to cook your food. AUTO COOK has preset Cook Powers for five categories: Frozen Entree, Casserole, Baked Goods, Fresh/

Canned Vegetables, and Frozen Vegetables. All you do is touch the Number Pad assigned to the desired category (see chart on next page) and START. Your microwave oven does the rest.

NOTE: See "Microwave cooking chart" on page 53 for cooking with cooking time and Cook Power.

1. Put food in oven and close door.

2. Choose AUTO COOK.

TOUCH



YOU SEE



3. Choose food category.

(See "Auto cook chart" on next page for food categories to choose from.)

Example for food category 5
(Frozen Vegetables):

TOUCH



YOU SEE



4. Start oven.

When oven detects vapor from food, cooking time is displayed.

TOUCH



YOU SEE



(this time will vary)

At end of cooking time:

YOU SEE



Auto cook chart

CATEGORY	FOOD
1	Frozen Entree
2	Casserole
3	Baked Goods
4	Fresh/Canned Vegetables
5	Frozen Vegetables

Using BEVERAGE

BEVERAGE lets you heat or reheat a beverage by touching just one pad. A sensor in your oven detects the vapor released by the beverage, and the amount of vapor detected tells the oven how long to heat your beverage.

1. Place cup of beverage in oven and close door.

2. Choose BEVERAGE.

TOUCH



YOU SEE



After three seconds:

YOU SEE



When oven detects vapor from beverage, heating time is displayed. Example:

YOU SEE



(this time will vary)

At end of heating time:

YOU SEE



Using REHEAT

REHEAT lets you reheat food by touching just one pad. A sensor in your oven detects the vapor released by the food, and the amount of vapor detected tells the oven how long to heat your food. To reheat food that is at room temperature, touch REHEAT once. To reheat food that is frozen, touch REHEAT twice.

NOTE: See "Reheating chart" on page 52 for reheating with cooking time and Cook Power.

1. Place food in oven and close door.

2. Choose REHEAT.

Example for reheating frozen food:

TOUCH



YOU SEE



twice

After three seconds, your oven will begin heating. When oven detects vapor from food, heating time is displayed. Example:

YOU SEE



(this time will vary)

At end of heating time:

YOU SEE



Using POPCORN

POPCORN lets you pop commercially packaged microwave popcorn by touching just one pad. A sensor in your oven detects the vapor released by the popcorn, and the amount of vapor detected tells the oven how long to cook.

Pop only one package at a time. If you are using a microwave popcorn popper, follow manufacturer's instructions.

Cooking performance may vary with brand. Try several brands to decide which gives best popping results. For best results, use fresh bags of popcorn.

WARNING

Fire and Burn Hazard

- Do not try to repop unpopped kernels and do not reuse popcorn bags. Fire could result.
- If you remove the rack right after popping popcorn, use oven mitts. It will be very hot and could burn you.

1. Place bag on rack and close door.

2. Choose POPCORN.

TOUCH

POPCORN

YOU SEE

POP-

and

CORN

After "CORN" is displayed for three seconds, your oven will begin heating.

YOU SEE

POP-

When oven detects vapor from popcorn, popping time is displayed. Example:

YOU SEE

5:30

(remaining cook time alternates with "POP-" and "CORN"; this time will vary)

At end of popping time:

YOU SEE

END

Using BAKED POTATO

BAKED POTATO lets you bake a potato by touching just one pad. A sensor in your oven detects the vapor released by the potato, and the amount of vapor detected tells the oven how long to bake your potato. Before baking, remember to pierce potato with a fork several times. After cooking, let potato stand 5 minutes wrapped in foil.

1. Place potato on paper towel in oven and close door.

2. Choose BAKED POTATO.

After three seconds, the oven will begin heating.

TOUCH



YOU SEE



When oven detects vapor from potato, heating time is displayed. Example:

YOU SEE



(this time will vary)

At end of cooking time:

YOU SEE



Using SLOWCOOK/SIMMER

SLOWCOOK/SIMMER lets you stew or simmer food by touching just one pad. A sensor in your oven detects the vapor released by the food, and the amount of vapor detected tells the oven how long to stew or simmer your food.

1. Place food in oven and close door.

2. Choose SLOWCOOK/SIMMER.

After three seconds, the oven will begin heating at 70% Cook Power. Oven will then cook at 50% Cook Power and finally at 30% Cook Power.

After 2nd and 3rd stages, oven will simmer food.

Oven will keep food warm at 10% Cook Power for 99 minutes, 99 seconds.

TOUCH



YOU SEE



YOU SEE



Using EASY MINUTE

EASY MINUTE lets you cook food for one minute at 100% Cook Power or add an extra minute to your cooking cycle. You can also use it to extend cooking time in multiples of one minute, up to 99 minutes.

NOTES:

- To **extend** cooking time in multiples of one minute, touch EASY MINUTE repeatedly during cooking.
- You can **enter** EASY MINUTE only after closing the door, after touching CANCEL/OFF, or during cooking.

- If you touch EASY MINUTE during cooking, the oven will cook at the currently selected Cook Power. If you touch EASY MINUTE after cooking is over, the oven will cook at 100% Cook Power.
- You cannot use EASY MINUTE with POPCORN, AUTO ROAST, REHEAT, BEVERAGE, AUTO COOK, or CUSTOM DEFROST.
- You cannot use EASY MINUTE to start the oven if any program, other than the Minute Timer, is on the Display.

1. Make sure food is in oven.

2. Choose EASY MINUTE.

Example for cooking for one minute:

TOUCH



YOU SEE

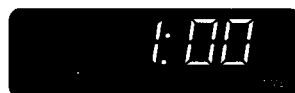

Adding or subtracting cook time

If a preset cook time is too long or too short, you can increase or decrease the cook time by 10% after choosing the function. You can only increase or decrease cook time before cooking starts.

To increase cook time by 10%:

TOUCH



YOU SEE



(example for auto roast)

To decrease cook time by 10%:

TOUCH



YOU SEE



To reset to the original cook time:

TOUCH



YOU SEE



Caring for Your Microwave Hood Combination

To make sure your microwave oven looks good and works well for a long time, you should maintain it properly. For proper care, please follow these instructions carefully.

Cleaning the microwave oven

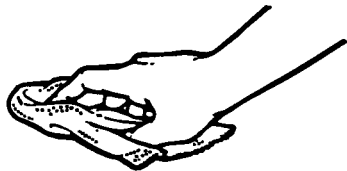

Wipe often with warm, sudsy water and a sponge or paper towel.

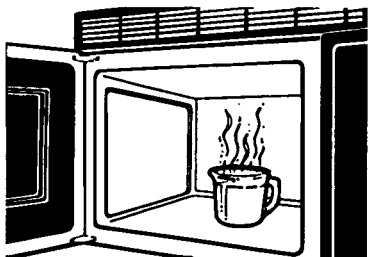

For stubborn soil, **boil** a cup of water in the oven for 2 or 3 minutes. Steam will soften the soil. To get rid of odors inside the oven, **boil** a cup of water with lemon juice.

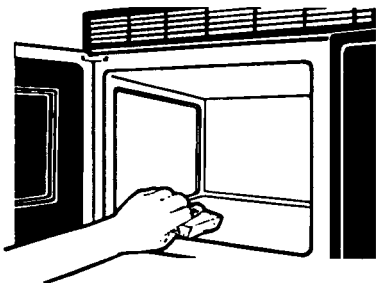

Be sure to keep the areas clean where the door and oven frame touch when closed. Use only mild, nonabrasive soaps or detergents applied with a sponge or paper towel when cleaning surfaces. Rinse well.

⚠ WARNING

Product Damage Hazard

Abrasive cleansers, steel-wool pads, gritty wash cloths, etc., could damage the control panel, and the interior and exterior oven surfaces. Use a sponge with a mild detergent or a paper towel with spray glass cleaner. Apply spray glass cleaner to paper towel; do not spray directly on oven.

Cleaning the bi-level cooking rack

- Wash by hand with a mild detergent and a soft or nylon scrub brush. Dry completely.
- Do not use abrasive scrubbers or cleansers to clean rack.

Caring for the filters

The grease filters should be removed and cleaned often, at least once a month.

NOTE: If your microwave hood combination is installed to recirculate air, the charcoal filter (Part No. 4158314 [black], 4158439 [white] or 4378403 [almond]) should be replaced every 6-12 months. The charcoal filter cannot be cleaned.

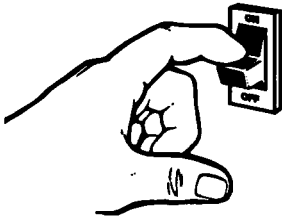

1. For your personal safety, **turn off** the electric power at the main power supply.

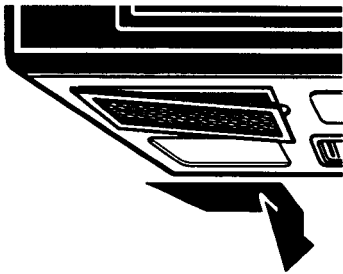

2. To remove grease filters, slide each filter to the side. Pull filters downward and push to the other side. The filter will drop out.

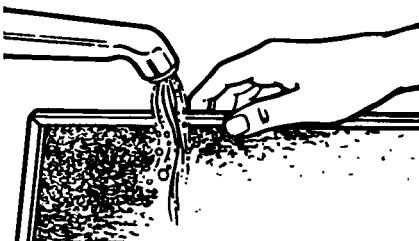

3. Soak grease filters in hot water and a mild detergent. **Scrub and swish** to remove embedded dirt and grease.

Rinse well and shake to dry. Do not use ammonia or place in a dishwasher. The aluminum will darken.



4. To replace grease filters, slide filter in the frame slot on one side of the opening. **Push** filter upward and **push** to the other side to lock into place.

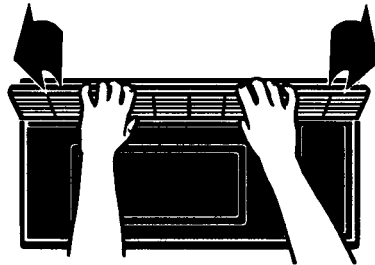

5. To remove charcoal filter: remove the vent cover mounting screws.
6. Tip the cover forward, then lift out to remove.

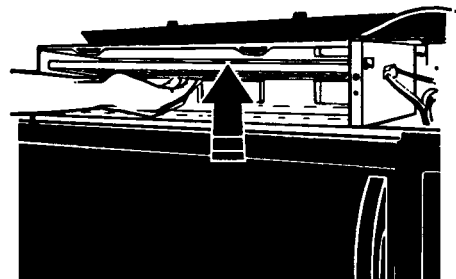

7. Lift the back of the charcoal filter. Slide the filter straight out.

continued on next page

Caring for Your Microwave Hood Combination

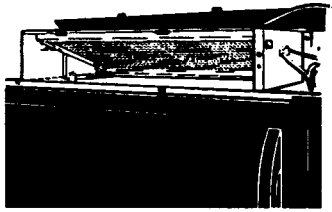

8. Slide a new charcoal filter into place. The filter should rest at the angle shown.

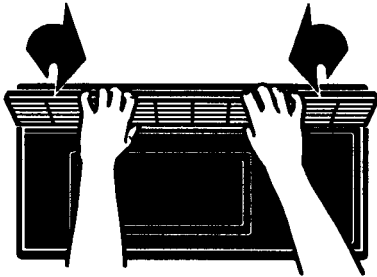

9. Slide the bottom of the vent cover into place. Push the top until it snaps into place. Replace the mounting screws.

10. Turn the power back on at the main power supply.

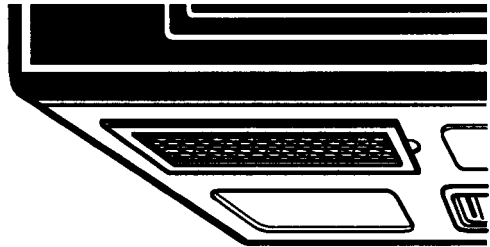

11. Do not operate the hood without the filters in place.

Replacing the cooktop and oven lights

⚠ WARNING

Fire and Electrical Shock Hazard

- Use only candelabra-base bulbs, 30-watt maximum. Failure to do so could result in fire.
- Turn off power at main power supply before replacing the light bulb. Failure to do so could result in electrical shock.

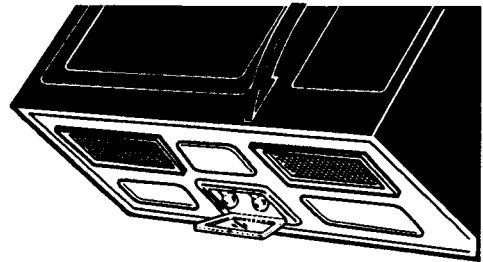

2. Remove the bulb cover mounting screws.
3. We recommend replacing bulb(s) with candelabra-base 30-watt bulb(s) available from your authorized KitchenAid servicer (Part No. 4158432).

The cooktop light

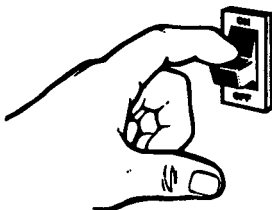

1. Turn off power at the main power supply.

The oven light

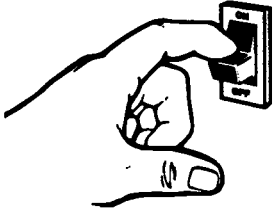

1. Turn off power at the main power supply.

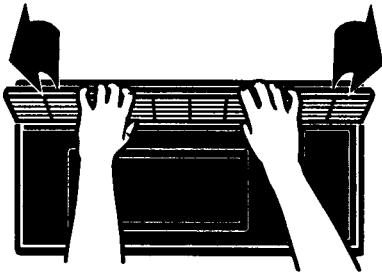

2. Remove the vent cover mounting screws.
3. Tip the cover forward, then lift out to remove.

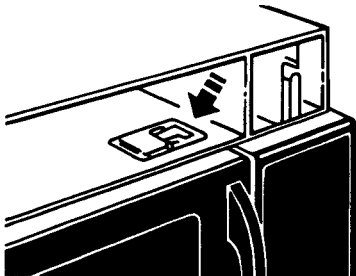

4. Remove bulb holder mounting screw.

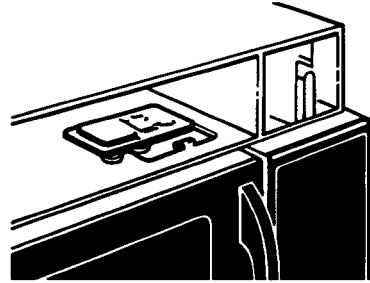

5. Lift up the bulb holder.
6. We recommend replacing the bulb with a candelabra-base 30-watt bulb available from your authorized KitchenAid servicer (Part No. 4158432).
7. Replace the bulb holder and mounting screw.

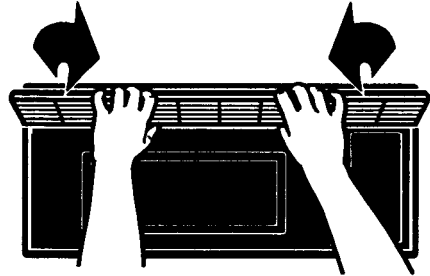

8. Slide the top of the vent cover into place. Push the bottom until it snaps into place. Replace the mounting screws. Turn the power back on at the main power supply.

Cooking Guide

Reheating chart

Times are approximate and may need to be adjusted to individual taste. **NOTE:** See "Using REHEAT" on page 42 for instructions on how to reheat by touching just one Command Pad.

ITEM	STARTING TEMP	TIME/POWER	PROCEDURE
Meat (Chicken pieces, chops, hamburgers, meat loaf slices) 1 serving 2 servings	Refrigerated Refrigerated	1-2 min at 70% 2½-4½ min at 70%	Cover loosely.
Meat Slices (Beef, ham, pork, turkey) 1 or more servings	Room temp Refrigerated	45 sec-1 min per serving at 50% 1-3 min per serving at 50%	Cover with gravy or wax paper. Check after 30 sec per serving.
Stirrable Casseroles and Main Dishes 1 serving 2 servings 4-6 servings	Refrigerated Refrigerated Refrigerated	2-4 min at 100% 4-6 min at 100% 6-8 min at 100%	Cover. Stir after half the time.
Nonstirrable Casseroles and Main Dishes 1 serving 2 servings 4-6 servings	Refrigerated Refrigerated Refrigerated	5-8 min at 50% 9-12 min at 50% 13-16 min at 50%	Cover with wax paper.
Soup, Cream 1 cup 1 can (10¾ oz)	Refrigerated Room temp	3-4½ min at 50% 5-7 min at 50%	Cover. Stir after half the time.
Soup, Clear 1 cup 1 can (10¾ oz)	Refrigerated Room temp	2½-3½ min at 100% 4-5½ min at 100%	Cover. Stir after half the time.
Pizza 1 slice 1 slice 2 slices 2 slices	Room temp Refrigerated Room temp Refrigerated	15-25 sec at 100% 30-40 sec at 100% 30-40 sec at 100% 45-55 sec at 100%	Place on paper towel.
Vegetables 1 serving 2 servings	Refrigerated Refrigerated	¾-1½ min at 100% 1½-2½ min at 100%	Cover. Stir after half the time.
Baked Potato 1 2	Refrigerated Refrigerated	1-2 min at 50% 2-3 min at 50%	Cut potato lengthwise and then several times crosswise. Cover with wax paper.
Breads (Dinner or breakfast roll) 1 roll 2 rolls 4 rolls	Room temp Room temp Room temp	8-12 sec at 50% 11-15 sec at 100% 18-22 sec at 100%	Wrap single roll, bagel or muffin in paper towel. To reheat several, line plate with paper towel. Cover with another paper towel.
Pie Whole 1 slice	Refrigerated Refrigerated	5-7 min at 70% 30 sec at 100%	

Microwave cooking chart

Times are approximate and may need to be adjusted to individual taste. **NOTE:** See "Using AUTO COOK" on page 40 for instructions on how to cook without entering cooking times or Cook Powers.

MEATS, POULTRY, FISH, SEAFOOD Allow standing time after cooking.			VEGETABLES (continued) Cook at 100% Cook Power.		
FOOD	COOK POWER	TIME	FOOD	TIME	
Bacon	100%	45 sec to 1 min 15 sec per slice	Carrots (1 lb)	8-12 min	
Ground Beef for Casseroles (1 lb)	100%	4-6 min	Cauliflower (medium head)	6-9 min	
Hamburger Patties (2)	100%	1st side 2 min 2nd side 1½ to 2½ min	Corn on the Cob (2)	4-9 min	
Hamburger Patties (4)	100%	1st side 2½ min 2nd side 2-3 min	(4)	6-16 min	
Meat Loaf (1½ lbs)	100%	13-19 min	Potatoes, Baked (4 medium)	13-19 min	
Chicken Pieces	100%	6-9 min/lb Internal temperature should be 185°F after standing.	Squash, Summer (1 lb)	3-8 min	
Turkey Breast	100% then 70%	5 min 8-12 min/lb Internal temperature should be 185°F after standing.	OTHER		
Fish Fillets (1 lb)	100%	5-6 min	FOOD	COOK POWER	TIME
Scallops and Shrimp (1 lb)	100%	3½-5½ min	Applesauce (4 servings)	100%	7-10 min
VEGETABLES Cook at 100% Cook Power.			Baked Apples (4)	100%	4-6 min
FOOD	TIME		Chocolate (melt 1 square)	50%	1-2 min
Beans, Green or Yellow (1 lb)	6-12 min		Eggs, Scrambled (2)	100%	1 min 15 sec to 1 min 45 sec
Broccoli (1 lb)	6-10 min		(4)		2-3 min
			Hot Cereals (1 serving) (4 servings)	100%	1½-5 min 4½-7 min
			Nachos (large plate)	50%	1½-2½ min
			Water for Beverage (1 cup) (2 cups)	100%	2½-4 min 4½-6 min

Microwave cooking tips

Amount of food

- **The more food** you want to prepare, the longer it takes. A rule of thumb is that a double amount of food requires almost double the time. If one potato takes four minutes to cook, you need about seven minutes to cook two potatoes.
- **If you want to cook two meals or containers of food** at the same time, you can do so with the Bi-Level Cooking Rack. For example, you can cook two frozen dinners or reheat two plates of food by placing one on the rack and one under the rack.

Starting temperature of food

- **The lower the temperature** of the food being put into the microwave oven, the longer it takes to cook. Food at room temperature will be reheated more quickly than food at refrigerator temperature.

Composition of food

- **Food with a lot of fat and sugar** will be heated faster than food containing a lot of water. Fat and sugar will also reach a higher temperature than water in the cooking process.
- **The more dense the food**, the longer it takes to heat. "Very dense" food like meat takes longer to reheat than lighter, more porous food like sponge cakes.

Size and shape

- **Smaller pieces of food** will cook faster than larger pieces and same-shaped pieces of food cook more evenly than irregularly shaped foods.
- **With unevenly shaped foods**, the thinner parts will cook faster than the thicker areas. **Place** the thinner parts of chicken wings and legs in the center of the dish.

Stirring, turning foods

- **Stirring and turning foods** distributes heat quickly to the center of the dish and avoids overcooking at the outer edges of the food.

Covering food

Cover food to:

- **Reduce** splattering
- **Shorten** cooking times
- **Retain** food moisture

All coverings that allow microwaves to pass through are suitable.

Releasing pressure in foods

- **Several foods** (for example: baked potatoes, sausages, egg yolks, and some fruits) are tightly covered by a skin or membrane. This can cause the food to burst from steam building up in them during cooking. To relieve the pressure and to prevent bursting, **prick** these foods with a fork, cocktail pick or toothpick.

Using standing time

- **Always allow food to stand** for a while after cooking. Standing time after defrosting, cooking, or reheating always improves the result since the temperature will then be evenly distributed throughout the food.
- **When cooking in a microwave oven**, food continues to cook even when the microwave energy is turned off. Food is no longer cooked by microwaves, but it is still being cooked by the high heat left over from the microwave oven.
- **The length of the standing time** depends on the volume and density of the food. Sometimes it can be as short as the time it takes you to remove the food from the oven and take it to the serving table. However, with larger, denser food, the standing time may be as long as 10 minutes. During standing time, the internal food temperature will rise as much as 46°F as the food finishes cooking.

Arranging food

For best results, distribute food evenly on the plate. You can do this in several ways:

- **If you are cooking several items of the same food**, such as baked potatoes, place them in a ring pattern for uniform cooking.
- **When cooking foods of uneven shapes or thickness**, place the smaller or thinner area of the food towards the center of the dish where it will be heated last.
- **Arrange uneven foods**, such as fish, in the oven with the tails to the center.
- **If you are saving a meal in the refrigerator** or “plating” a meal for reheating, **arrange** the thicker, denser foods to the outside of the plate and the thinner or less dense foods in the middle.
- **Place thin slices of meat** on top of each other or interlace them.
- **Place thicker slices of meat**, such as meat loaf and sausages, close to each other.
- **Reheat gravy or sauce** in a separate container.
- **When you cook or reheat whole fish**, **score** the skin – this prevents cracking.
- **Shield the tail and head of whole fish** with small pieces of foil to prevent overcooking and ensure the foil does not touch the sides of the oven.
- **Do not** let food or container touch the top or sides of the oven. This will prevent possible arcing.

Using aluminum foil

Metal containers usually should not be used in a microwave oven. There are, however, some exceptions. If you have purchased food which is prepackaged in an aluminum foil container, then refer to the instructions on the package. It is possible to use disposable containers, but it generally takes longer and the final result will not be as good as if food were placed in plastic or paper containers.

If you use aluminum containers without package instructions, follow these guidelines:

- **Place** container in a glass bowl and add some water so that it covers the bottom of the container, not more than ¼ inch high. This ensures even heating of the container bottom.
- **Always remove** the lid to avoid damage to the oven.
- **Use only** undamaged containers.
- **Do not use** containers taller than ¾".
- **Container must be** half filled.
- **To avoid sparking**, there must be a minimum ¼" between the aluminum container and the walls of the oven and also between two aluminum containers.
- **Thickness of the food layer** must be greater than thickness of the aluminum.
- **Reheating food** in aluminum foil containers usually takes up to double the time compared to reheating in plastic, glass, china, or paper containers. The time when food is ready will vary a great deal.
- **Let food stand** for 2-3 minutes after heating so that heat is spread evenly throughout container.

Cooking you should not do in your microwave oven

- **Do not** do canning of foods in the oven. Closed glass jars may explode, resulting in damage to the oven or possible personal injury.
- **Do not** use the oven to sterilize objects (baby bottles, etc.). It is difficult to maintain the high temperature required for safe sterilization.

Questions and Answers

QUESTIONS	ANSWERS
Can I use a rack in my microwave oven so that I may reheat or cook on two levels at a time?	You can use a rack only if rack is supplied with your microwave oven. Use of any rack not supplied with the microwave oven can result in poor cooking performance and/or arcing.
Can I use either metal or aluminum pans in my microwave oven?	Usable metal includes aluminum foil for shielding (use small, flat pieces), small skewers and shallow foil trays (if tray is ¼ inch deep and filled with food to absorb microwave energy). Never allow metal to touch walls or door. (For more information, see page 55.)
Sometimes the door of my microwave oven appears wavy. Is this normal?	This appearance is normal and does not affect the operation of your oven.
What are the humming noises that I hear when my microwave oven is operating?	You hear the sound of the transformer when the magnetron tube cycles on.
Why does the dish become hot when I microwave food in it? I thought that this should not happen.	As the food becomes hot it will conduct the heat to the dish. Be prepared to use hot pads to remove food after cooking.
What does "standing time" mean?	"Standing time" means that food should be taken out of the oven and covered for additional time after cooking. This process allows the cooking to finish, saves energy and frees the oven for another purpose.
Can I pop popcorn in my microwave oven? How do I get the best results?	Yes. Pop packaged microwave popcorn following manufacturer's guidelines or use the preprogrammed POPCORN pad. Do not use regular paper bags. Use the "listening test" by stopping the oven as soon as the popping slows to a "pop" every one or two seconds. Do not try to repop unpopped kernels. You can also use special microwave poppers. When using a popper, be sure to follow manufacturer's directions. Do not pop popcorn in glass utensils.
Why does steam come out of the air exhaust vent?	Steam is normally produced during cooking. The microwave oven has been designed to vent this steam out the top vent.

If You Need Assistance or Service

Questions or comments? Call our toll-free Consumer Assistance Center telephone number, 1-800-422-1230, 24 hours a day.

This section is designed to help you save the cost of a service call. Part 1 of this section outlines possible problems, their causes, and actions you can take to solve each problem. Parts 2 and 3 tell you what to do if you still need assistance or service. When calling our Consumer Assistance Center for help or calling for service, please provide a detailed description of the problem, your appliance's complete model and serial numbers and the purchase or installation date. (See page 2.) This information will help us respond properly to your request.

1. Before calling for service ...

If your appliance should fail to operate, review the following list before calling your dealer. You could save the cost of a service call.

PROBLEM	POSSIBLE CAUSE	SOLUTION
Nothing will operate	The unit is not wired into a live circuit with the proper voltage.	Contact a qualified KitchenAid service technician to wire unit into a live circuit with the proper voltage. (See Installation Instructions.)
	A household fuse has blown or a circuit breaker has tripped.	Replace household fuse or reset circuit breaker.
	The electric company has experienced a power failure.	Check electric company for a power failure.
The micro-wave oven will not run	You are using the oven as a timer.	Touch TIMER CANCEL to cancel the Minute Timer.
	If you are using the Temperature Probe, probe is not plugged tightly into its socket.	Plug Temperature Probe tightly into its socket.
	The door is not firmly closed and latched.	Firmly close and latch door.
	You did not touch START .	Touch START .
	You did not follow directions exactly.	Check instructions for the function you are operating.
	An operation that was programmed earlier is still running.	Touch CANCEL/OFF to cancel previous programming.

continued on next page

If You Need Assistance or Service

PROBLEM	POSSIBLE CAUSE	SOLUTION
Microwave cooking times seem too long	The electric supply to your home or wall outlets is low or lower than normal.	Your electric company can tell you if the line voltage is low. Your electrician or service technician can tell you if the outlet voltage is low. See page 7.
	The Cook Power is not at the recommended setting.	Check "Microwave cooking chart" on page 53.
	There is not enough cooking time for the amount of food being cooked.	Allow for more time when cooking more food at one time.
The Display shows a time counting down but the oven is not cooking	The oven door is not closed completely.	Completely close oven door.
	You have set the controls as a minute timer.	Touch TIMER CANCEL to cancel the Minute Timer.
You do not hear the Programming Tone	The command is not correct.	Re-enter command.
The microwave oven turns off too soon or not soon enough when using the Temperature Probe	Probe is not pushed far enough into the food.	Insert at least $\frac{1}{3}$ of probe into the food.
	Probe is not positioned correctly in the food.	Position probe tip in the center of the food.
	When cooking roasts, you have not let roast stand after cooking.	Allow roast to stand for a few minutes after cooking.
	Probe is not plugged in correctly.	Plug probe tightly into its socket.
	Cook Power is not set correctly.	Reset the Cook Power.
	Probe temperature is not set correctly.	Reset the probe temperature.
The Display shows "888:88"	There has been a power interruption.	Reset the clock.

2. If the problem is not due to one of the items listed in Step 1:

- Call KitchenAid Consumer Assistance Center:

1-800-422-1230

One of our trained consultants can instruct you in how to obtain satisfactory operation from your appliance or, if service is necessary, recommend a qualified service company in your area.

- If you prefer, write to:

Consumer Assistance Center
KitchenAid
2000 N State Route 63
Benton Harbor, MI 49022-2692

Please include a daytime phone number in your correspondence.

3. If you need service:

- Call your dealer or the repair service he recommends.
- All service should be handled locally by the dealer from whom you purchased the unit or an authorized KitchenAid servicer.
- If you are unable to obtain the name of a local authorized KitchenAid servicer, call our Consumer Assistance Center telephone number (see Step 2).

4. If you are not satisfied with the action taken:

- Contact the Major Appliance Consumer Action Panel (MACAP). MACAP is a group of independent consumer experts that voices consumer views at the highest levels of the major appliance industry.
- Contact MACAP only when the dealer, authorized servicer and KitchenAid have failed to resolve your problem.

Major Appliance Consumer Action Panel
20 North Wacker Drive
Chicago, IL 60606

- MACAP will in turn inform us of your action.

Don't forget, KitchenAid offers a full line of quality home appliances.

Built-in Refrigerators	Trash Compactors	Ranges & Cooktops
Freestanding Refrigerators	Hot Water Dispensers	Microwave Ovens
50-Pound Ice Makers	Food Waste Disposers	Washers & Dryers
Dishwashers	Built-in Ovens	Mixers & Blenders

For more information on these appliances, or the one you have purchased, call our toll-free Consumer Assistance Center telephone number, **1-800-422-1230**.

KitchenAid®

Microwave Hood

Warranty

LENGTH OF WARRANTY:	KITCHENAID WILL PAY FOR:	KITCHENAID WILL NOT PAY FOR:
<p>ONE YEAR FULL WARRANTY FROM DATE OF INSTALLATION.</p>	<p>Replacement parts and repair labor costs to correct defects in materials or workmanship. Service must be provided by an authorized KitchenAid servicing outlet.</p>	<p>A. Service calls to:</p> <ol style="list-style-type: none"> 1. Correct the installation of the oven. 2. Instruct you how to use the oven. 3. Replace house fuses or correct house wiring. <p>B. Repairs when oven is used in other than normal home use.</p> <p>C. Damage resulting from accident, alteration, misuse, abuse, improper installation or installation not in accordance with local electrical codes.</p> <p>D. Any labor costs during the limited warranties.</p> <p>E. Replacement parts or repair labor costs for units operated outside the United States.</p> <p>F. Pickup and delivery. This product is designed to be repaired in the home.</p> <p>G. Repairs to parts or systems caused by unauthorized modifications made to the appliance.</p> <p style="text-align: right;">5/93</p>
<p>SECOND THROUGH FIFTH YEAR LIMITED WARRANTY FROM DATE OF INSTALLATION.</p>	<p>Replacement of microwave magnetron tube on microwave oven to correct defects in materials or workmanship.</p> <p>For convection cooking models, replacement parts for the electric element to correct defects in materials or workmanship.</p>	

KITCHENAID DOES NOT ASSUME ANY RESPONSIBILITY FOR INCIDENTAL OR CONSEQUENTIAL DAMAGES. Some states do not allow the exclusion or limitation of incidental or consequential damages, so this exclusion may not apply to you.

This warranty gives you specific legal rights and you may also have other rights which may vary from state to state.

If you need service, first see the "If You Need Assistance or Service" section of this book. After checking "If You Need Assistance or Service," additional help can be found by calling our Consumer Assistance Center telephone number, **1-800-422-1230**, from anywhere in the U.S.A.

KitchenAid
Benton Harbor, MI, U.S.A. 49022-2692

PART NO. 3874W500662/4358595