

ELECTRIC RANGE USER INSTRUCTIONS

THANK YOU for purchasing this high-quality product. If you should experience a problem not covered in TROUBLESHOOTING, please visit our website at www.kitchenaid.com for additional information. If you still need assistance, call us at 1-800-422-1230. You will need your model and serial number, located on the oven frame behind the top right side of the oven door.

Para obtener acceso a “Instrucciones para el usuario de la estufa eléctrica” en español, o para obtener información adicional acerca de su producto, visite: www.kitchenaid.com

Deberá tener a mano el número de modelo y de serie, que están ubicados en el marco del horno, detrás del lado derecho superior de la puerta del horno.

Table of Contents

RANGE SAFETY	2
The Anti-Tip Bracket	2
FEATURE GUIDE	4
COOKTOP USE	6
Cookware	9
Home Canning	9
OVEN USE	10
Electronic Oven Controls	10
Sabbath Mode	11
Aluminum Foil.....	11
Positioning Racks and Bakeware	11
Split Oven Rack (on some models)	12
Roll-Out Rack.....	13
Oven Vent.....	13
Baking and Roasting.....	14
Broiling	14
Convection Cooking	14
EasyConvect™ Conversion.....	15
Proofing Bread	15
Cook Time.....	15
Warming Drawer	16
Slow Cook.....	16
RANGE CARE	17
Clean Cycle	17
General Cleaning.....	18
Oven Light.....	18
TROUBLESHOOTING	19
ACCESSORIES	21
WARRANTY	22

RANGE SAFETY

Your safety and the safety of others are very important.

We have provided many important safety messages in this manual and on your appliance. Always read and obey all safety messages.



This is the safety alert symbol.

This symbol alerts you to potential hazards that can kill or hurt you and others.

All safety messages will follow the safety alert symbol and either the word "DANGER" or "WARNING."

These words mean:

⚠ DANGER

You can be killed or seriously injured if you don't immediately follow instructions.

⚠ WARNING

You can be killed or seriously injured if you don't follow instructions.

All safety messages will tell you what the potential hazard is, tell you how to reduce the chance of injury, and tell you what can happen if the instructions are not followed.

The Anti-Tip Bracket

The range will not tip during normal use. However, the range can tip if you apply too much force or weight to the open door without having the anti-tip bracket fastened down properly.

⚠ WARNING

Tip Over Hazard

A child or adult can tip the range and be killed.

Verify the anti-tip bracket has been properly installed and engaged per installation instructions.

Re-engage anti-tip bracket if range is moved.

Do not operate range without anti-tip bracket installed and engaged.

Failure to follow these instructions can result in death or serious burns to children and adults.

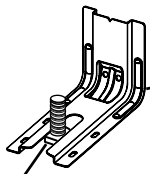

Anti-Tip Bracket

Range Foot

To verify the anti-tip bracket is installed and engaged:

- Slide range forward.
- Look for the anti-tip bracket securely attached to floor or wall.
- Slide range back so rear range foot is under anti-tip bracket.
- See installation instructions for details.

State of California Proposition 65 Warnings:

WARNING: This product contains one or more chemicals known to the State of California to cause cancer.

WARNING: This product contains one or more chemicals known to the State of California to cause birth defects or other reproductive harm.

IMPORTANT SAFETY INSTRUCTIONS

WARNING: To reduce the risk of fire, electrical shock, injury to persons, or damage when using the range, follow basic precautions, including the following:

- **WARNING:** TO REDUCE THE RISK OF TIPPING OF THE RANGE, THE RANGE MUST BE SECURED BY PROPERLY INSTALLED ANTI-TIP DEVICES. TO CHECK IF THE DEVICES ARE INSTALLED PROPERLY, SLIDE RANGE FORWARD, LOOK FOR ANTI-TIP BRACKET SECURELY ATTACHED TO FLOOR OR WALL, AND SLIDE RANGE BACK SO REAR RANGE FOOT IS UNDER ANTI-TIP BRACKET.
- **CAUTION:** Do not store items of interest to children in cabinets above a range or on the backguard of a range – children climbing on the range to reach items could be seriously injured.
- Proper Installation – Be sure the range is properly installed and grounded by a qualified technician.
- Never Use the Range for Warming or Heating the Room.
- Do Not Leave Children Alone – Children should not be left alone or unattended in area where the range is in use. They should never be allowed to sit or stand on any part of the range.
- Wear Proper Apparel – Loose-fitting or hanging garments should never be worn while using the range.
- User Servicing – Do not repair or replace any part of the range unless specifically recommended in the manual. All other servicing should be referred to a qualified technician.
- Storage in or on the Range – Flammable materials should not be stored in an oven or near surface units.
- Do Not Use Water on Grease Fires – Smother fire or flame or use dry chemical or foam-type extinguisher.
- Use Only Dry Potholders – Moist or damp potholders on hot surfaces may result in burns from steam. Do not let potholder touch hot heating elements. Do not use a towel or other bulky cloth.
- DO NOT TOUCH SURFACE UNITS OR AREAS NEAR UNITS – Surface units may be hot even though they are dark in color. Areas near surface units may become hot enough to cause burns. During and after use, do not touch, or let clothing or other flammable materials contact surface units or areas near units until they have had sufficient time to cool. Among those areas are the cooktop and surfaces facing the cooktop.
- Use Proper Pan Size – The range is equipped with one or more surface units of different size. Select utensils having flat bottoms large enough to cover the surface unit heating element. The use of undersized utensils will expose a portion of the heating element to direct contact and may result in ignition of clothing. Proper relationship of utensil to burner will also improve efficiency.
- Never Leave Surface Units Unattended at High Heat Settings – Boilover causes smoking and greasy spillovers that may ignite.
- Make Sure Reflector Pans or Drip Bowls Are in Place – Absence of these pans or bowls during cooking may subject wiring or components underneath to damage.

- Protective Liners – Do not use aluminum foil to line surface unit drip bowls or oven bottoms, except as suggested in the manual. Improper installation of these liners may result in a risk of electric shock, or fire.
- Glazed Cooking Utensils – Only certain types of glass, glass/ceramic, ceramic, earthenware, or other glazed utensils are suitable for range-top service without breaking due to the sudden change in temperature.
- Utensil Handles Should Be Turned Inward and Not Extend Over Adjacent Surface Units – To reduce the risk of burns, ignition of flammable materials, and spillage due to unintentional contact with the utensil, the handle of a utensil should be positioned so that it is turned inward, and does not extend over adjacent surface units.
- Do Not Soak Removable Heating Elements – Heating elements should never be immersed in water.
- Do Not Cook on Broken Cooktop – If cooktop should break, cleaning solutions and spillovers may penetrate the broken cooktop and create a risk of electric shock. Contact a qualified technician immediately.
- Clean Cooktop With Caution – If a wet sponge or cloth is used to wipe spills on a hot cooking area, be careful to avoid steam burn. Some cleaners can produce noxious fumes if applied to a hot surface.
- Use Care When Opening Door – Let hot air or steam escape before removing or replacing food.
- Do Not Heat Unopened Food Containers – Build-up of pressure may cause container to burst and result in injury.
- Keep Oven Vent Ducts Unobstructed.
- Placement of Oven Racks – Always place oven racks in desired location while oven is cool. If rack must be moved while oven is hot, do not let potholder contact hot heating element in oven.
- DO NOT TOUCH HEATING ELEMENTS OR INTERIOR SURFACES OF OVEN – Heating elements may be hot even though they are dark in color. Interior surfaces of an oven become hot enough to cause burns. During and after use, do not touch, or let clothing or other flammable materials contact heating elements or interior surfaces of oven until they have had sufficient time to cool. Other surfaces of the appliance may become hot enough to cause burns – among these surfaces are oven vent openings and surfaces near these openings, oven doors, and windows of oven doors.

For self-cleaning ranges –

- Do Not Clean Door Gasket – The door gasket is essential for a good seal. Care should be taken not to rub, damage, or move the gasket.
- Do Not Use Oven Cleaners – No commercial oven cleaner or oven liner protective coating of any kind should be used in or around any part of the oven.
- Clean Only Parts Listed in Manual.
- Before Self-Cleaning the Oven – Remove broiler pan and other utensils.

For units with ventilating hood –

- Clean Ventilating Hoods Frequently – Grease should not be allowed to accumulate on hood or filter.
- When flambeing foods under the hood, turn the fan on.

SAVE THESE INSTRUCTIONS

This induction cooktop generates and uses ISM frequency energy that heats cookware by using an electromagnetic field. It has been tested and complies with Part 18 of the FCC Rules for ISM equipment. This induction cooktop meets the FCC requirements to minimize interference with other devices in residential installation.

This induction cooktop may cause interference with television or radio reception. If interference occurs, the user should try to correct the interference by:

- Relocating the receiving antenna of the radio or television.
- Increasing the distance between the cooktop and the receiver.
- Connecting the receiver into a different outlet.

It is the user’s responsibility to correct any interference.

NOTE: People with a pacemaker or similar medical device should use care when standing near this induction cooktop while it is on. The electromagnetic field may affect the pacemaker or similar device. Consult your doctor, or the manufacturer of the pacemaker or similar medical device for additional information about its effects with electromagnetic fields of the induction cooktop.

IMPORTANT: Pan size, material and positioning are very important to achieve the best results when using an induction cooktop. See “Induction Cooking” in the “Cooktop Use” section and the “Cookware” section before using the cooktop.

FEATURE GUIDE

This manual covers several models. Your model may have some or all of the items listed. Refer to this manual or the Frequently Asked Questions (FAQs) section of our website at www.kitchenaid.com for more detailed instructions.

⚠ WARNING

Food Poisoning Hazard

Do not let food sit in oven more than one hour before or after cooking.

Doing so can result in food poisoning or sickness.

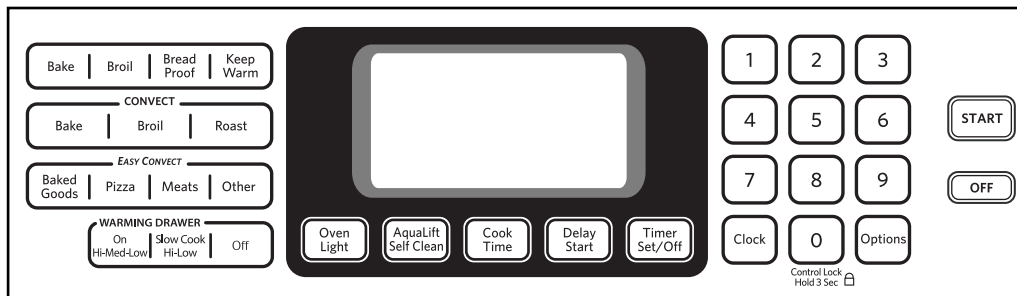

KEYPAD	FEATURE	INSTRUCTIONS
CLOCK	Clock	This clock can use a 12- or 24-hour cycle. See “Oven Use” section. <ol style="list-style-type: none"> 1. Press CLOCK. 2. Press “3” for AM or “6” for PM. 3. Press the number keypads to set the time of day. 4. Press START.
OVEN LIGHT	Oven cavity light	While the oven door is closed, press the OVEN LIGHT keypad to turn the light on and off. The oven light will come on when the oven door is opened.
TIMER SET/OFF	Oven timer	The Timer can be set in hours or minutes up to 9 hours and 59 minutes. <ol style="list-style-type: none"> 1. Press TIMER. 2. Press the number keypads to set the length of time in hr-min-min. Leading zeroes do not have to be entered. For example, for 2 minutes, enter “2.” 3. Press TIMER or START to begin the countdown. If enabled, end-of-cycle tones will sound at end of countdown. 4. Press TIMER twice to cancel the Timer and return to the Time of Day. Do not press the Off keypad because the oven will turn off. 5. If the Timer is running, but not in the display, press TIMER to display the countdown for 5 seconds.
START	Cooking start	The Start pad begins any oven function. If Start is not pressed within 2 minutes after pressing a keypad, the function is canceled and the time of day is displayed.
OFF	Range function	The Off keypad stops any oven function except the Clock, Timer, Control Lock, and Warming Drawer or Slow Cook Drawer (on some models).

KEYPAD	FEATURE	INSTRUCTIONS
BAKE	Baking and roasting	<ol style="list-style-type: none"> 1. Press BAKE. 2. Press the number keypads to set a temperature other than 350°F (177°C) in 5° increments between 170°F and 500°F (77°C and 260°C). 3. Press START. 4. To change the temperature, repeat steps 1 and 2. Press START for the change to take effect. 5. Press OFF when finished.
BROIL	Broiling	<ol style="list-style-type: none"> 1. Press BROIL. 2. Select the broiling temperature by pressing 1 - high (500°F [261°C]), 2 - medium (450°F [234°C]) or 3 - low (400°F [204°C]). 3. Press START and allow the oven to preheat for 5 minutes. 4. Position the cookware in the oven and close the door. 5. Press OFF when finished.
CONVECT BAKE	Convection cooking	<ol style="list-style-type: none"> 1. Press CONVECT BAKE. 2. Press the number keypads to set a temperature other than 325°F (162°C) in 5° increments between 170°F and 500°F (77°C and 260°C). 3. Press START. 4. To change the temperature, repeat steps 1 and 2. Press START for the change to take effect. 5. Press OFF when finished.
CONVECT ROAST	Convection cooking	<ol style="list-style-type: none"> 1. Press CONVECT ROAST. 2. Press the number keypads to set a temperature other than 325°F (162°C) in 5° increments between 170°F and 500°F (77°C and 260°C). 3. Press START. 4. To change the temperature, repeat steps 1 and 2. Press START for the change to take effect. 5. Press OFF when finished.
CONVECT BROIL	Convection cooking	<ol style="list-style-type: none"> 1. Press CONVECT BROIL. 2. Press the number keypads to set a temperature other than 450°F (234°C) in 5° increments between 170°F and 500°F (77°C and 260°C). 3. Press START. 4. To change the temperature, repeat steps 1 and 2. Press START for the change to take effect. 5. Press OFF when finished.
EASYCONVECT CONVERSION	Recipe conversion for convection cooking	<p>NOTE: For best results, preheat your oven to the required temperature prior to using EasyConvect™ Conversion. After preheating is complete, press the OFF key before using EasyConvect™ Conversion.</p> <ol style="list-style-type: none"> 1. Press the appropriate EasyConvect™ key (MEATS, PIZZA, BAKED GOODS or OTHER). 2. Press the number keypads to enter the standard cooking temperature, then press START. 3. Press the number keypads to enter the standard cook time, then press START. 4. Place food in the oven at the appropriate time. Check food for doneness before the stop time is reached. If food will not be done when stop time is reached, add more cooking time before time elapses. See “Cook Time” section. At the end of the stop time, the oven will automatically turn off. 5. Press OFF when finished. <p>Refer to the “EasyConvect™ Conversion” section for more information.</p>
BREAD PROOF	Proofing bread	<ol style="list-style-type: none"> 1. Press BREAD PROOF until the desired proof is displayed (“Standard Proof” or “Rapid Proof”). NOTE: “Rapid” operates at a slightly higher temperature. 2. Press START. Let the dough rise until nearly doubled in size. Proofing time may vary depending on dough type and quantity. 3. Press OFF when finished proofing. Refer to the “Proofing Bread” section for more information.
KEEP WARM	Hold warm	<p>Food must be at serving temperature before placing it in the warmed oven.</p> <ol style="list-style-type: none"> 1. Press KEEP WARM. 2. Set temperature between 145°F (63°C) and 190°F (88°C) using the number keypads. The default temperature is 170°F (78°C). 3. Press START. 4. Press OFF when finished.
DELAY START	Delayed start	<p>The DELAY START keypad is used to enter the starting time for an oven function with a delayed start.</p>

KEYPAD	FEATURE	INSTRUCTIONS
COOK TIME	Cook time	Cook Time allows the oven to be set to turn on at a certain time of day, cook for a set length of time, and/or shut off automatically. Delay start should not be used for foods such as breads and cakes because they may not bake properly. To set a Cook Time or a Delayed Cook Time, see “Cook Time” section.
WARMING DRAWER ON/OFF	Warming drawer (on some models)	<ol style="list-style-type: none"> 1. Press WARMING DRAWER ON to select the Warming Drawer function at the Low setting. 2. To select a higher temperature setting, press WARMING DRAWER ON a second time for the Medium setting and a third time for the High setting. 3. Press START to begin preheating the warming drawer. 4. Allow the warming drawer to preheat for 15 minutes. 5. Place the cooked food(s) in the warming drawer. 6. Press WARMING DRAWER OFF to turn off the heating element. Refer to the “Warming Drawer” section for information.
WARMING DRAWER SLOW COOK/OFF	Slow cook drawer (on some models)	<ol style="list-style-type: none"> 1. Press WARMING DRAWER SLOW COOK to select the Slow Cook function at the Low setting. 2. To select a higher temperature setting, press WARMING DRAWER SLOW COOK a second time for the High setting. 3. Place the food(s) in the warming drawer. 4. Press START to begin heating the warming drawer. 5. Press WARMING DRAWER OFF to turn off the heating element. Refer to the “Warming Drawer” section for information.
AQUALIFT SELF CLEAN	AquaLift™ self-clean cycle	See the “Clean Cycle” section.
CONTROL LOCK hold 3 sec. to lock	Oven control lockout	No keypads for the oven and cooktop will function with the controls locked. <ol style="list-style-type: none"> 1. Check that all cooktop and oven functions are off, including Timer and the timed cooking function. The oven temperature must be below 400°F (205°C) with no cooktop hot surface indicators on. 2. Press and hold the “0” keypad for 3 seconds. 3. If enabled, a tone will sound, and “CONTROL LOCKED” will be displayed. 4. Repeat to unlock.
OPTIONS	Oven use functions	Enables you to personalize the audible tones and oven operation to suit your needs. See the “Oven Use” section.

COOKTOP USE

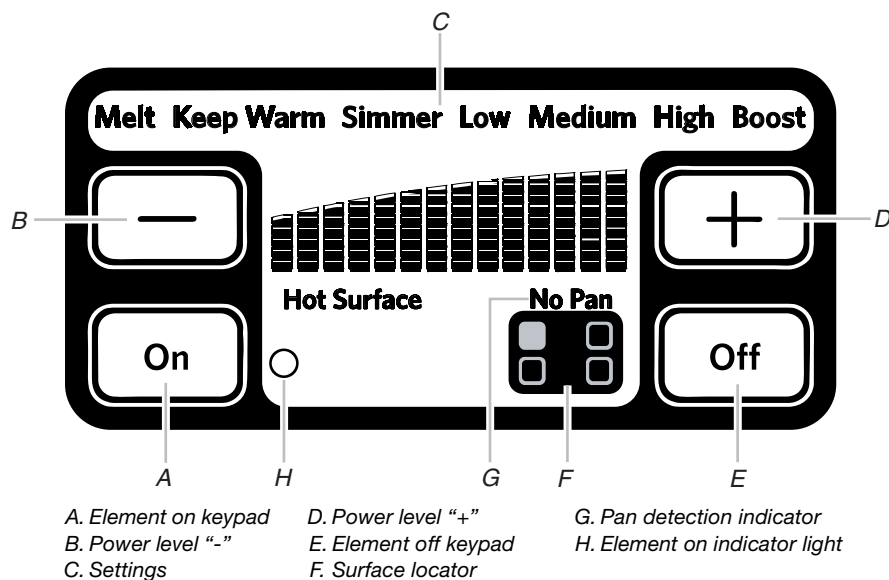

Induction Cooking

Induction cooking is quite different from traditional forms of cooking. The heat is generated directly in the pan, keeping the cooking surface cooler than with a traditional element.

Induction cooking does not lose as much heat as traditional forms because all the heat is created in the pan itself.

The cooktop heats up or cools down quickly after the controls are set. It also stops heating when the pan is removed without turning off the power.

Food spilled on the cooktop surface will not burn because the glass is not heated. Induction cooking allows for immediate cleaning after use because the heat is created in the pan. The cooktop surface will be warm from contact with the hot pan.

Pan size, material (see “Cookware” section), and positioning are very important to achieve maximum wattage.

The diameter of the pan’s base should be equal to the size of the element.

If the pan is too small, the burner does not sense the pan and will not activate.

Cooktop Controls - Touch-Activated Custom Control Temperature Management System

⚠ WARNING



Fire Hazard

Turn off all controls when done cooking.

Failure to do so can result in death or fire.

The electronic touch controls offer a variety of heat settings for optimal cooking results. When melting foods such as chocolate or butter, the surface cooking area can be set to MELT for very low temperature operation.

To keep cooked foods warm, the surface cooking area can be set to KEEP WARM.

For maximum element operation, all cooktop touch-activated controls can be set to High when bringing liquids to a fast and rapid boil. Touch the “-” pad to immediately reach the HIGH setting after touching ON. For elements with a Boost setting, press “+” to go from High to Boost.

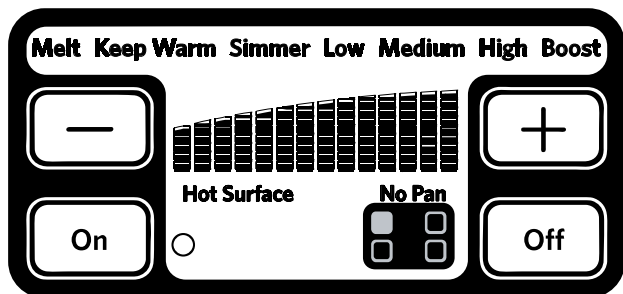

To Use Elements:

1. Place a filled pan on the surface cooking area.
2. Touch ON.
3. Touch the “+” or “-” pad to increase or decrease power.
4. To choose a power level between HIGH and MELT, touch and hold either pad until the desired level has been reached.
5. When finished cooking, touch OFF.

NOTE: Boost power level can only be selected for a maximum of two elements at a time: one on the left side and one on the right side of the cooktop.

Use the following chart as a guide when setting heat levels. Some of the settings will have multiple heating levels.

SETTING	RECOMMENDED USE
BOOST	<ul style="list-style-type: none"> ■ Bring liquid to a boil.
HIGH	<ul style="list-style-type: none"> ■ Bring liquid to a boil and/or hold a rapid boil. ■ Quickly brown or sear food.
MEDIUM	<ul style="list-style-type: none"> ■ Maintain a slow boil. ■ Fry or sauté foods. ■ Cook soups, sauces and gravies.
LOW	<ul style="list-style-type: none"> ■ Stew or steam food.
SIMMER	<ul style="list-style-type: none"> ■ Simmer (range of simmer temperatures)
KEEP WARM	<ul style="list-style-type: none"> ■ Keep cooked foods warm.
MELT	<ul style="list-style-type: none"> ■ Melt chocolate or butter.

REMEMBER: When range is in use, the entire cooktop area may become hot.

Hot Surface Indicators

The Hot Surface Indicators are located in each of the cooktop touch controls. “Hot Surface” will light up and glow as long as the surface cooking area is too hot to touch, even after the surface cooking area is turned off.

Control Lock

The Control Lock feature will avoid unintended use of the cooktop and the oven. All cooktop and oven functions must be off, including the Timer. The oven temperature must be below 400°F (205°C), and all hot surface indicators must be off. If these conditions are not met, the oven control will display “FEATURE NOT AVAILABLE.”

To Lock/Unlock Control:

1. Before locking, ensure that all oven and cooktop functions are off, including the Timer, and that all hot surface indicators are off.
2. Press and hold the “0” pad on the oven control for 3 seconds until “CONTROL LOCKED” appears on the oven control display.
3. Repeat to unlock.

Pan Detection

If the system cannot recognize the pan on the element, or if the pan has been removed from the surface cooking area, “No Pan” will light up on the element control.

If a pan is not placed within 30 seconds, the zone element will switch Off.

Melt

The Melt function is available on all the surface cooking elements, and is ideal for melting chocolate or butter without scorching.

To Use:

1. Touch ON.
2. Touch the “+” pad once for MELT.

When finished cooking, touch OFF to turn surface cooking area off.

Keep Warm

⚠️ WARNING

Food Poisoning Hazard

Do not let food sit for more than one hour before or after cooking.

Doing so can result in food poisoning or sickness.

The Keep Warm function is available on all the surface cooking elements, has three settings and is ideal for keeping cooked foods warm. The lowest setting is for delicate sauces, the medium setting is for soups, and the highest setting is for soups and meats. Do not use it to heat cold foods. One hour is the recommended maximum time to maintain food quality.

- Use only cookware recommended for oven and cooktop use.
- Cover all foods with a lid or aluminum foil. When warming baked goods, allow a small opening in the cover for moisture to escape.
- Do not use plastic wrap to cover food. Plastic wrap may melt.
- Use pot holders or oven mitts to remove food.

To Use:

1. Touch ON.
2. Touch the “+” pad twice for KEEP WARM at the Low setting, three times for Medium, and four times for High.

When finished cooking, touch OFF to turn surface cooking area off.

Simmer

The Simmer function is available on all the surface cooking elements. It has an adjustable heat setting for more precise simmer control.

The recommended setting will vary depending on the quantity and density of the food being cooked as well as the size and shape of the cookware and if a lid is being used during cooking. The Simmer setting may be too high for some combinations of food and cookware. Select a lower heat setting, such as Keep Warm or Melt, if the Simmer temperature is too high.

To Use:

1. Touch ON.
2. Touch the “+” pad five times for SIMMER at the Low setting and six times for SIMMER at the High setting.

When finished cooking, touch OFF to turn surface cooking area off.

Performance Boost Function

This function allows you to increase the heat setting level above the maximum heat setting for 10 minutes or less.

NOTES:

Performance Boost function is available on only 1 surface cooking area at a time within a zone. See the following illustrations for zones.

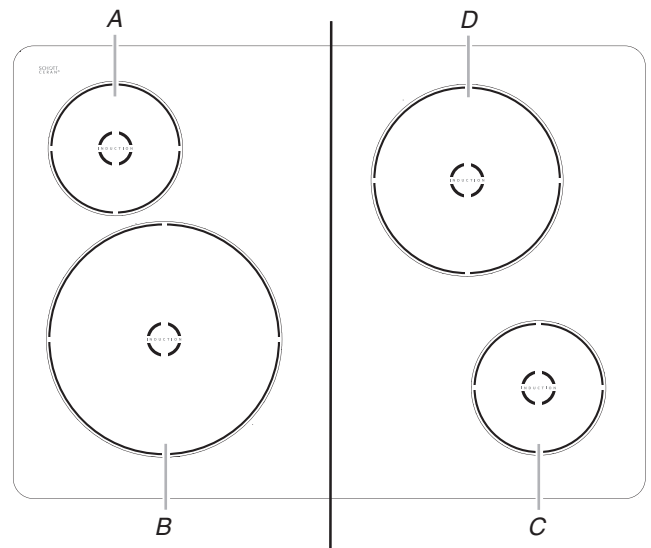

Zone 1

- A. Surface cooking area 1
- B. Surface cooking area 2

Zone 2

- C. Surface cooking area 3
- D. Surface cooking area 4

If you attempt to use Performance Boost on more than one surface cooking area in the same zone, the first surface cooking area selected for Performance Boost will automatically be set back to the highest power available setting. The last surface cooking area selected will be set to Performance Boost.

1. Advance to the HIGH heat setting for the selected element.
2. Press the “+” keypad to advance to the Boost setting.
3. Press the “-” keypad to reduce the power setting to a lower level, or press OFF to turn the element Off.

NOTE: The Performance boost function may automatically deactivate to keep the internal electronic components of the cooktop from becoming too hot.

Ceramic Glass

Clean the cooktop after each use to help avoid scratches, pitting, abrasions and to condition the glass surface. Ceramic glass cooktop cleaner and a cooktop scraper are also recommended for stubborn soils. Do not use abrasive cleaners, cleaning pads or harsh chemicals for cleaning. The Cooktop Care Kit Part Number 31605 contains all of the items needed to clean and condition your ceramic glass cooktop. Refer to the “Range Care” section for additional information.

IMPORTANT: To avoid permanent damage to the cooktop surface and to make soils easier to remove, clean the cooktop after each use to remove all soils.

- Avoid storing jars or cans above the cooktop. Dropping a heavy or hard object onto the cooktop could crack the cooktop.
- To avoid damage to the cooktop, do not leave a hot lid on the cooktop. As the cooktop cools, air can become trapped between the lid and the cooktop, and the ceramic glass could break when the lid is removed.
- For foods containing sugar in any form, clean up all spills and soils as soon as possible. Allow the cooktop to cool down slightly. Then, while wearing oven mitts, remove the spills while the surface is still warm. If sugary spills are allowed to cool down, they can adhere to the cooktop and can cause pitting and permanent marks.
- To avoid scratches, do not slide cookware or bakeware across the cooktop.
- To avoid damage to the cooktop, do not allow objects that could melt, such as plastic or aluminum foil, to touch any part of the entire cooktop.
- To avoid damage to the cooktop, do not use the cooktop as a cutting board.

- Use cookware about the same size as the surface cooking area. Cookware should not extend more than ½" (1.3 cm) outside the area. Cookware should not be much smaller than the cooking surface area, or the control may not detect the pan. If "No Pan" illuminates on the control, try a larger pan or move the pan to a smaller element.

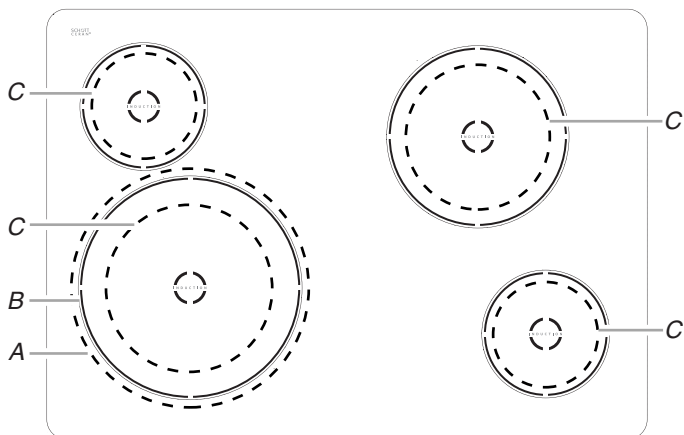

A. ½" (1.3 cm) Maximum overhang from graphic on all burners
 B. Outer edge of cooktop graphic
 C. Minimum pan size:
 1½" (3.8 cm) from outer edge graphic on large burner,
 1" (2.5 cm) from outer edge graphic on medium burner,
 ½" (1.3 cm) from outer edge graphic on small burners

- Use flat-bottomed cookware for best heat conduction and energy efficiency. Cookware with rounded, warped, ribbed or dented bottoms could cause uneven heating and poor cooking results.
- Determine flatness by placing the straight edge of a ruler across the bottom of the cookware. While you rotate the ruler, no space or light should be visible between it and the cookware.

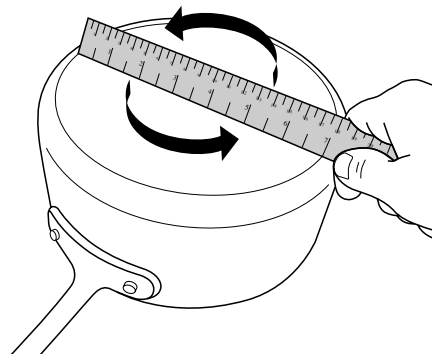

- Make sure the bottoms of pots and pans are clean and dry before using them. Residue and water can leave deposits when heated.

Cookware

IMPORTANT: This range has induction cooktop elements. Pan size, material and positioning are very important to achieve the best results. See "Induction Cooking" in the "Cooktop Use" section before using the cooktop.

Only ferromagnetic pans can be used for induction cooking.

Ferromagnetic materials include:

- Enameled steel
- Cast iron
- Stainless steel designed for induction cooking

Non-ferromagnetic materials include:

These types of pans will not work with induction cooking.

- Stainless steel
- Glass
- Ceramic
- Copper or aluminum pans

To find out whether your pans can be used with an induction cooktop, flip the pan over, hold a magnet to the bottom of the pan, and see whether it sticks. If the magnet sticks to the bottom of the pan, the pan is ferromagnetic and can be used for induction cooking.

The number on the surface cooking area heat setting display will flash if no pan is placed on the surface cooking area, or the pan is not made of the right material, or it is not the right size. It will stop flashing once a suitable pan is placed on the surface cooking area. If you take longer than 90 seconds to place the correct pan on the surface cooking area, the surface cooking area will turn off.

Ideal cookware should have a flat bottom, straight sides and a well-fitting lid, and the material should be of medium-to-heavy thickness.

Choose the correct pan size for each surface cooking area. The diameter of the pan's base should correspond to the size of the surface cooking area.

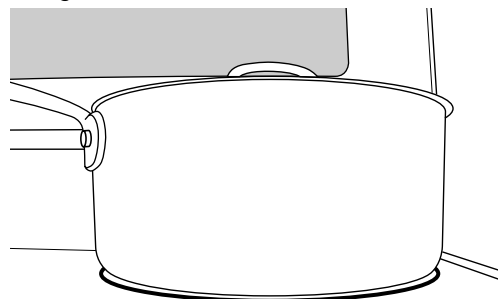

NOTE: Cookware manufacturers often give the diameter across the top of the pan. This is usually larger than the diameter of the base. Pans with rough finishes may scratch the cooktop.

Home Canning

Canning can be performed on the induction cooktop. See the "Cookware" section to check if the canner will work on the induction cooktop. When canning for long periods, alternate the use of surface cooking areas or elements between batches. This allows time for the most recently used areas to cool.

- Center the canner on the largest surface cooking area or element. On electric cooktops, canners should not extend more than ½" (1.3 cm) beyond the surface cooking area or element.

- Do not place canner on 2 surface cooking areas or elements at the same time.
- On ceramic glass models, use only flat-bottomed canners to avoid damage to the cooktop and elements.
- For more information, contact your local agricultural extension office, or refer to published home canning guides. Companies that manufacture home canning products can also offer assistance.

OVEN USE

Odors and smoke are normal when the oven is used the first few times, or when it is heavily soiled.

IMPORTANT: The health of some birds is extremely sensitive to the fumes given off. Exposure to the fumes may result in death to certain birds. Always move birds to another closed and well-ventilated room.

Electronic Oven Controls

Control Display

The display will flash when powered up or after a power loss. Press OFF to clear. When oven is not in use, the time of day is displayed.

Tones

Tones are audible signals, indicating the following:

One tone

- Valid pad press
- Oven is preheated (long tone)
- Function has been entered
- Reminder (on some models), repeating each minute after the end-of-cycle tones

Three tones

- Invalid pad press

Four tones

- End of cycle

Use the Options key to change the tone settings.

Options

Many features of the oven control can be adjusted to meet your personal needs. These changes are made using the Options key.

Use the Options key to scroll through the features that can be changed. Each press of the Options key will advance the display to the next setting. After selecting the feature to be changed, the control will prompt you for the required input. After the setting is saved by pressing Start, the control will exit Options and display the time of day. Details of all of the feature changes are explained in the following sections.

Press OFF to exit Options.

Fahrenheit and Celsius

The temperature is preset at Fahrenheit, but can be changed to Celsius.

To change:

1. Press OPTIONS until "TEMP UNIT" is displayed.
2. The current setting will be displayed.
3. Press the "1" keypad to adjust the setting.
4. Press START to save the setting.
5. Press OFF to exit and display the time of day.

Audible Tones Disable

Turns off all tones, including the end of cycle tone and key press tones. Reminder tones are still active when all tones are disabled.

1. Press OPTIONS until "SOUNDS" is displayed.
2. The current setting will be displayed.
3. Press the "1" keypad to adjust the setting.
4. Press START to save the setting.
5. Press OFF to exit and display the time of day.

Sound Volume

Sets the pitch of the tone to either high or low.

1. Press OPTIONS until "SOUND VOLUME" is displayed.
2. The current setting will be displayed.
3. Press the "1" keypad to adjust the setting.
4. Press START to save the setting.
5. Press OFF to exit and display the time of day.

End of Cycle Tone

Activates or turns off the tones that sound at the end of a cycle.

1. Press OPTIONS until "END TONE" is displayed.
2. The current setting will be displayed.
3. Press the "1" keypad to adjust the setting.
4. Press START to save the setting.
5. Press OFF to exit and display the time of day.

Key Press Tones

Activates or turns off the tones when a keypad is pressed.

1. Press OPTIONS until "KEYPRESS TONE" is displayed.
2. The current setting will be displayed.
3. Press the "1" keypad to adjust the setting.
4. Press START to save the setting.
5. Press OFF to exit and display the time of day.

Reminder Tones Disable

Turns off the short repeating tone that sounds every 1 minute after the end of cycle tones.

1. Press OPTIONS until "REMINDER TONE" is displayed.
2. The current setting will be displayed.
3. Press the "1" keypad to adjust the setting.
4. Press START to save the setting.
5. Press OFF to exit and display the time of day.

12/24 Hour Clock

1. Press OPTIONS until "12/24 HOUR" is displayed.
2. The current setting will be displayed.
3. Press the "1" keypad to adjust the setting.
4. Press START to save the setting.
5. Press OFF to exit and display the time of day.

Demo Mode

IMPORTANT: This feature is intended for use on the sales floor with 120 V power connection and permits the control features to be demonstrated without heating elements or burners turning on. If this feature is activated, the oven will not work.

1. Press OPTIONS until "DEMO MODE" is displayed.
2. The current setting will be displayed.
3. Press the "1" keypad to adjust the setting.
4. Press START to save the setting.
5. Press OFF to exit and display the time of day.

12-Hour Shutoff

The oven control is set to automatically shut off the oven 12 hours after the oven initiates a cook or clean function. This will not interfere with any timed or delay cook functions.

1. Press OPTIONS until "12-HR AUTO-OFF" is displayed.
2. The current setting will be displayed.
3. Press the "1" keypad to adjust the setting.
4. Press START to save the setting.
5. Press OFF to exit and display the time of day.

Languages - Scrolling Display Text

Language options are English, Spanish and French.

1. Press OPTIONS until "LANGUAGE" is displayed.
2. The current setting will be displayed.
3. Press the "1" keypad to adjust the setting.
4. Press START to save the setting.
5. Press OFF to exit and display the time of day.

Oven Temperature Offset Control

IMPORTANT: Do not use a thermometer to measure oven temperature because opening the oven door may cause element or burner cycling to give incorrect readings.

The oven provides accurate temperatures; however, it may cook faster or slower than your previous oven, so the temperature can be adjusted to personalize it for your cooking needs. It can be changed to Fahrenheit or Celsius.

To Adjust Oven Temperature:

1. Press OPTIONS until "TEMP CALIB" is displayed.
2. The current setting will be displayed. Press the "1" keypad to toggle between the oven and the warming drawer.
3. Press START to select the choice displayed in Step 2. Wait 10 seconds for the display to change then continue with Step 4.
4. Press the "1" keypad to increase the temperature in 5°F (3°C) increments, or press the "6" keypad to decrease the temperature in 5°F (3°C) increments. The range is from -30°F to +30°F (-18°C to +18°C).
5. Press START to save the setting.
6. Press OFF to exit and display the time of day.

Sabbath Mode

The Sabbath Mode sets the oven to remain on in a bake setting until turned off.

When the Sabbath Mode is set, only the Bake cycle will operate. All other cooking and cleaning cycles are disabled. No tones will sound, and the displays will not indicate temperature changes.

When the oven door is opened or closed, the oven light will not turn on or off and the heating elements will not turn on or off immediately.

To Enable Sabbath Mode Capability (one time only):

1. Open oven door.
2. Press 7-8-9-6. Three tones will sound. "SABBATH ON" or "SABBATH OFF" will appear in the display. If "SABBATH OFF" is displayed, Sabbath Mode is enabled. Continue with Step 4. If "SABBATH ON" is displayed, continue with Step 3.
3. Press START to change the displayed status.
4. Close oven door and press OFF. Sabbath Mode can be activated for baking.
NOTE: To disable the Sabbath Mode, repeat steps 1 - 4 to change the status from "SABBATH OFF" to "SABBATH ON."

To Activate Sabbath Mode:

1. Press BAKE.
2. Press the number keypad to set a temperature other than 350°F (177°C).
3. Press START.
For timed cooking in Sabbath Mode, press COOK TIME, then the number keypad to set the desired cook time.
4. Press OPTIONS. Three tones will sound. Then press "7." "Sab" will appear in the display.

To Adjust Temperature (when Sabbath Mode is running):

1. Press the number keypad as instructed by the scrolling text to select the new temperature.
NOTE: The temperature adjustment will not appear on the display. The scrolling text will be shown on the display as it was before the keypad was pressed.
2. Press START.

To Deactivate Sabbath Mode:

Press OPTIONS, then press "7" to return to regular baking or press OFF to turn off the range.

Aluminum Foil

IMPORTANT: To avoid permanent damage to the oven bottom finish, do not line the oven bottom with any type of foil or liner.

For best cooking results, do not cover entire oven rack with foil because air must be able to move freely.

Positioning Racks and Bakeware

IMPORTANT: To avoid permanent damage to the porcelain finish, do not place food or bakeware directly on the oven door or bottom.

Bakeware

To cook food evenly, hot air must be able to circulate. Allow 2" (5 cm) of space around bakeware and oven walls. Make sure that no bakeware piece is directly over another.

Racks

- Position racks before turning on the oven.
- Do not move racks with bakeware on them.
- Make sure racks are level.

To move a rack, pull it out to the stop position, raise the front edge, and then lift out. Use the following illustration and charts as a guide.

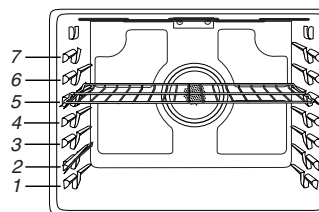

The oven has 7 positions for a flat rack, as shown in the previous illustration and the following table.

Flat Rack Position*	Type of Food
7	Broiling/searing meats, hamburgers, steaks
6	Broiled meats, poultry, fish
3 or 4	Most baked goods, casseroles
2	Roasted meats
1	Large roasts or poultry

*If your model has a Max Capacity Rack, the recessed ends must be placed in the rack position above the desired position of the food. See the following illustration.

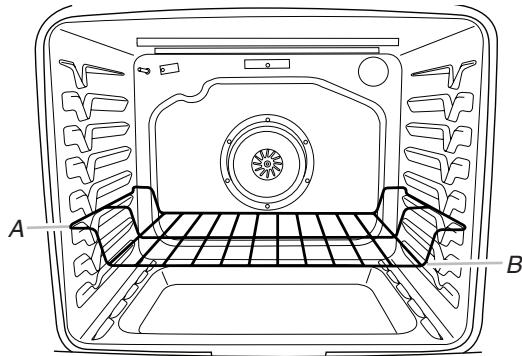

A. Ends of rack in position 3
B. Food in position 2

IMPORTANT: These rack positions are for flat racks. If a Max Capacity Rack is used, the rack position must be adjusted as shown in the previous figure.

Multiple Rack Cooking

2-rack: Use rack positions 2 and 5 for regular baking.

2-rack (convection only): Use rack positions 2 and 5.

3-rack (true convection only): Use rack positions 2, 4 and 6.

NOTE: The roll-out rack, which is available on some models, sits midway between adjacent rack positions. When used for 3-rack baking, it is recommended that it be placed in rack position 4. The roll-out rack will fit in all rack positions except rack position 7.

Best Performance on 2 Racks

For best results when baking cakes on 2 racks, use racks 2 and 5 with the Bake function. Place the cakes on the racks as shown. For best results baking 2 racks of cookies, use racks 2 and 5 with the Convection Bake function.

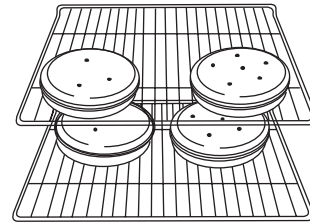

Split Oven Rack (on some models)

Split-Rack with Removable Insert

The split-rack with removable insert is a space maximizer. When the two are attached, they make a full rack. The insert can also be removed to provide room for large items such as a turkey and casseroles. Do not place more than 25 lbs (11.3 kg) on the split-rack.

The insert can also be used on the counter as a cooling rack.

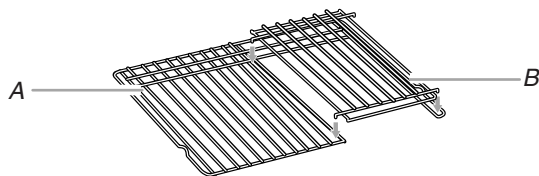

A. Split-rack
B. Removable insert

If you would like to purchase a split-oven rack, one may be ordered. See "Accessories" section to order.

To Use Racks:

1. Place a full rack in the lower section of the oven and position the split-rack above it.
2. Place large items on the right side of the full rack.
3. Place deeper, covered dishes on the left side of the full rack.
4. Place shallow dishes on the split-rack.
5. When finished cooking, slowly remove items.

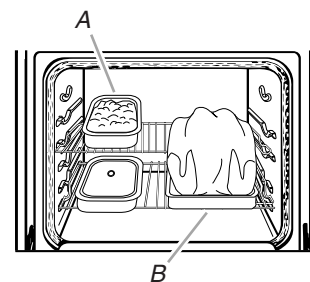

A. Place shallow dishes on the split-rack.
B. Large item placed on the right side of full-rack

Roll-Out Rack

The roll-out rack allows easy access to position and remove food in the oven. The roll-out rack will fit in all positions except the top rack position 7.

Open Position

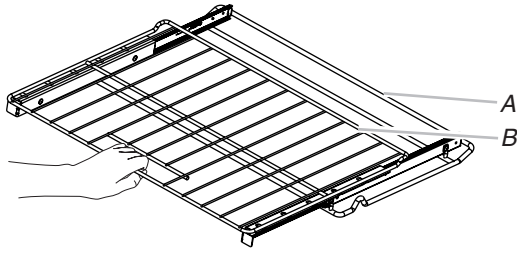

A. Rack frame
B. Sliding rack

NOTE: To fully extend the roll-out rack, pull the sliding rack forward, and continue pulling until the rack frame slides forward.

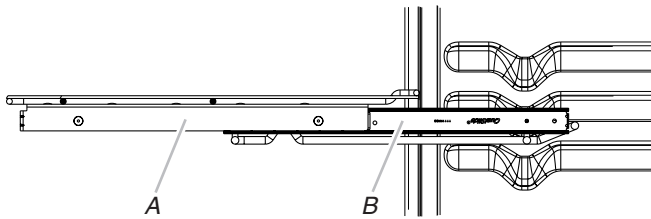

A. Sliding rack
B. Rack frame

Closed and Engaged Position

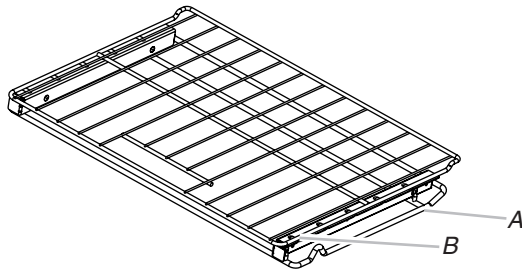

A. Rack frame
B. Sliding rack

To Insert Roll-Out Rack

1. Angle the front of the rack assembly up and insert the rack frame into the "V" cutout in the rack guides of the oven cavity.

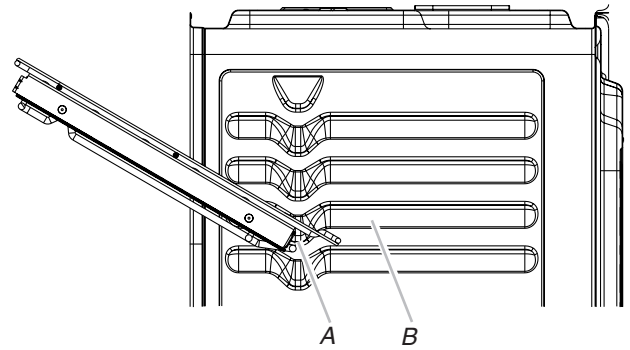

A. "V" cutout
B. Rack guides

2. Keep rack assembly lifted up at an angle and push in to bypass the lower "V" cutout.
3. Lower the front of the rack assembly and gently slide rack assembly into oven, bypassing the "V" cutouts. Push the rack assembly to the back of the oven until it stops.

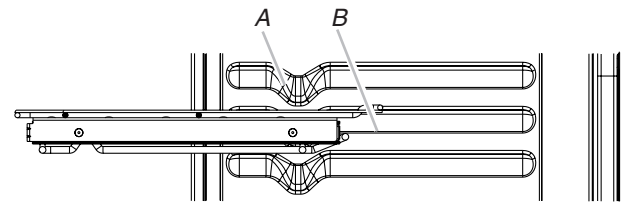

A. "V" cutout
B. Rack guides

To Remove Roll-out Rack

1. Push the sliding rack in completely so that it is in the closed and engaged position.
2. Using 2 hands, gently pull the sliding rack and the rack frame at the same time to the "V" cutout. Angle the rack so that the front is higher than the back, and gently pull rack past "V" cutout and then out of the oven.

To avoid damage to the sliding rack, do not place more than 25 lbs (11.4 kg) on the rack.

Do not clean the roll-out rack in a dishwasher. It may remove the rack's lubricant and affect its ability to slide.

See the "General Cleaning" section for more information.

Oven Vent

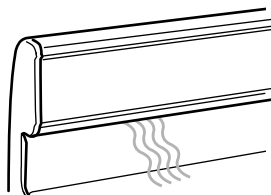

The oven vent releases hot air and moisture from the oven, and should not be blocked or covered. Blocking or covering the oven vent will cause poor air circulation, affecting cooking and cleaning results. Do not set plastics, paper or other items that could melt or burn near the oven vent.

Baking and Roasting

Temperature Management System

The oven control regulates the oven heat levels during preheat and bake to maintain a precise temperature range for optimal cooking results. The bake and broil elements or burners cycle on and off in intervals. On convection range models, the fan and convection element may run while preheating and may be cycled on and off for short intervals during Bake to provide the best results. This feature is automatically activated when the oven is in use.

Before baking and roasting, position racks according to “Positioning Racks and Bakeware” section. When roasting, it is not necessary to wait for the oven preheat cycle to end before putting food in unless it is recommended in the recipe.

Preheating

When Start is pressed, the oven will begin preheating. Once 100°F (38°C) is reached, the display temperature will increase as the actual temperature of the oven increases. When the preheat temperature is reached, a tone will sound, and the selected temperature will appear on the display. The time necessary to preheat the oven to 350°F (177°C) is approximately 15 minutes, depending on the model. Factors that have an impact on preheat times are: room temperature, starting oven temperature, and the number of oven racks. Unused oven racks can be removed prior to preheating your oven to reduce preheat time.

Broiling

Leave the door open 6" (15 cm) at the broil stop position to ensure proper broiling temperature. Preheat the oven for 5 minutes before putting food in unless recommended otherwise in the recipe. Position food on grid in a broiler pan, then place it in the center of the oven rack.

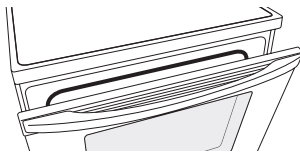

NOTE: Odors and smoke are normal the first few times the oven is used or if the oven is heavily soiled.

Changing the temperature when broiling allows more precise control when cooking. The lower the broil setting, the slower the cooking. Thicker cuts and unevenly shaped pieces of meat, fish and poultry may cook better at lower broil settings. Use racks 6 or 7 for broiling. The roll-out rack is not recommended for use in rack position 7. Refer to the “Positioning Racks and Bakeware” section for more information.

On lower settings, the broil element will cycle on and off to maintain the proper temperature.

- For best results, use a broiler pan and grid. It is designed to drain juices and help avoid spatter and smoke.

If you would like to purchase a broiler pan, one may be ordered. Please refer to the “Accessories” section for more information.

Convection Cooking

In a convection oven, the fan-circulated hot air continually distributes heat more evenly than the natural movement of air in a standard thermal oven. This movement of hot air helps maintain a consistent temperature throughout the oven, cooking foods more evenly, crisping surfaces while sealing in moisture and yielding crustier breads.

During convection cooking, the bake, broil and convection (true convection only) elements cycle on and off in intervals to maintain the oven temperature, while the fan circulates the hot air.

If the oven door is opened during convection cooking, the fan will turn off immediately. It will come back on when the oven door is closed.

NOTE: The oven door must be closed for convection broiling.

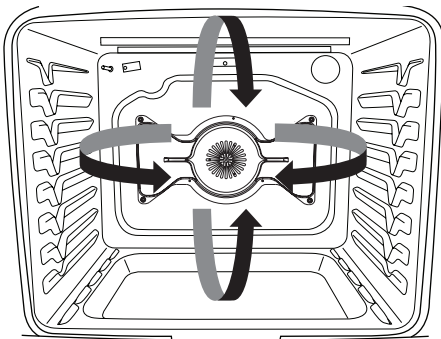

Position the racks according to the “Positioning Racks and Bakeware” section before starting convection cooking.

With convection cooking, most foods can be cooked at a lower temperature or at a shorter time. These adjustments can be made using the following chart or by using the EasyConvect™ Conversion feature on your range.

SETTING	GUIDELINES
CONVECT BAKE	Reduce the standard baking temperature 25°F (15°C)
CONVECT ROAST	Use standard recipe temperature. Cooking time may be reduced by 15-30% with Convect Roast so the food should be checked for doneness early.
CONVECT BROIL	Use standard recipe temperature. Cooking time may be reduced so the food should be checked for doneness early.

Bow Tie True Convection with T.H.E.™ Element

True convection adds an electric element around the convection fan to enhance the cooking performance. This feature enables three-rack baking in your range. Use the following Convect Options chart as a guide.

Convect Options

SETTING	FOODS
CONVECT BAKE	Single or multiple-rack baking for cookies, biscuits, breads, casseroles, tarts or tortes.
CONVECT BROIL	Thicker cuts or unevenly shaped pieces of meat, fish or poultry.
CONVECT ROAST	Whole chicken or turkey, vegetables, pork roasts, beef roasts.

EasyConvect™ Conversion

Convection cooking temperatures and times can differ from those of standard cooking. Depending upon the selected category, EasyConvect™ conversion automatically reduces the standard recipe temperature and/or time you input for convection cooking.

Foods are grouped into 4 general categories. Choose the category most appropriate for the food to be cooked. Use the following chart as a guide.

SETTING	FOODS
MEATS	Chicken: whole and pieces Meat loaf, Roasts: pork, beef and ham (Turkey and large poultry are not included because their cook time varies.)
BAKED GOODS	Biscuits, Breads: quick and yeast Cakes and Cookies Casseroles
PIZZA	Fresh pizza, Frozen pizza
OTHER	Frozen convenience foods: french fries, nuggets, fish sticks, lasagna

To Use:

NOTE: For best results, preheat your oven to the desired temperature prior to using Easy Convect™ Conversion. After preheating is complete, press the OFF key before using EasyConvect™ Conversion.

1. Press the EASY CONVECT pad for the desired option (MEATS, BAKED GOODS, PIZZA or OTHER).
2. Press number pads to enter standard cook temperature then press START.
3. Press number pads to enter standard cook time then press START.
4. Place the food in the oven.
Check food for doneness before the stop time is reached. If food will not be done when the stop time is reached, add more cooking time before time elapses (see "Cook Time" section). At the end of the stop time, the oven will automatically turn off.
5. Press OFF when finished.
6. Remove food from the oven.

Proofing Bread

Proofing bread prepares the dough for baking by activating the yeast. Follow the recipe directions as a guide. Standard Proof should be used for fresh dough, thawed dough, and for the first and second rise. Rapid Proof (on some models) operates at a slightly higher temperature than Standard Proof, and it can be used for the second rise of formed dough.

To Proof:

Before first proofing, place the dough in a lightly greased bowl and cover loosely with wax paper, coated with shortening. Place on rack guide 2 and close the oven door.

NOTE: If the temperature of the oven is greater than 100°F (38°C), "oven cooling" will be displayed until the temperature is less than 100°F (38°C).

1. Press BREAD PROOF until the desired proof is displayed ("Standard Proof" or "Rapid Proof").
 2. Press START.
Let the dough rise until nearly doubled in size. Proofing time may vary depending on dough type and quantity.
 3. Press OFF when finished proofing.
Before second proofing, shape the dough, place it in baking pan(s) and cover loosely. Follow the same placement and control steps above. Before baking, remove the cover.
- NOTE:** If the oven temperature is greater than 100°F (38°C), the display will indicate "oven cooling" until the temperature is below 100°F (38°C).

Cook Time

⚠ WARNING

Food Poisoning Hazard

Do not let food sit in oven more than one hour before or after cooking.

Doing so can result in food poisoning or sickness.

To Set a Timed Cook:

1. Press BAKE, CONVECT BAKE, or CONVECT ROAST.
2. Press the number keypads to enter a temperature other than the one displayed.
3. Press COOK TIME. The cook time oven indicator light will light up.
4. Press the number keypads to enter the length of time to cook.
5. Press START. The display will count down the time. When the time ends, the oven will shut off automatically.

The temperature and/or time setting can be changed at any time by repeating steps 2 - 3.

6. Press OFF to clear the display.

NOTE: The time setting for any timed cooking function, including EasyConvect™ Conversion, can be adjusted by following the previous steps 3 - 5.

To Set a Delayed Timed Cook:

1. Press BAKE, CONVECT BAKE, or CONVECT ROAST.
2. Press the number keypads to enter a temperature other than the one displayed.
3. Press COOK TIME. The cook time oven indicator light will light up.
4. Press number keypads to enter the length of time to cook.
5. Press DELAY START. The start time/delay oven indicator light will light up.
6. Press number keypads to enter the number of hours and/or minutes you want to delay the start time.
7. Press START.
When the start time is reached, the oven will automatically turn on. The temperature and/or time settings can be changed any time after pressing Start by repeating steps 2 - 7. When resetting the time and temperature, it is necessary to press Start between steps 4 and 5 to continue making changes.
When the set cook time ends, the oven will shut off automatically.
8. Press OFF to clear the display.

Warming Drawer

! WARNING

Food Poisoning Hazard

Do not let food sit for more than one hour before or after cooking.

Doing so can result in food poisoning or sickness.

The Warming Drawer is ideal for keeping hot cooked foods at serving temperature. It may also be used for warming breads and pastries.

Different types of food may be placed in the warming drawer at the same time. For best results, do not hold foods longer than 1 hour. For smaller quantities, pizza, or heat-sensitive foods, such as eggs, do not hold longer than 30 minutes.

Food must be at serving temperature before being placed in the warming drawer. Breads, pastries, and fruit pies may be heated from room temperature.

Remove food from plastic bags and place in oven-safe container. Cover foods with a lid or aluminum foil.

Do not cover with plastic wrap.

Empty serving dishes and ovenproof dishes can be heated while the warming drawer is preheating. Check the dish manufacturer's recommendations before warming the cookware.

Before using the warming drawer, wash the bottom of the drawer with soap and water. See "General Cleaning" section.

To Use:

1. Press WARMING DRAWER ON to select the Warming Drawer function at the Low setting.



2. To select a higher temperature setting, press WARMING DRAWER ON a second time for the Medium setting or a third time for the High setting.
3. Press START to begin preheating the warming drawer.
4. Allow the warming drawer to preheat for 15 minutes.
5. Place the cooked food(s) in the warming drawer.
6. Press WARMING DRAWER OFF to turn off the heating element.

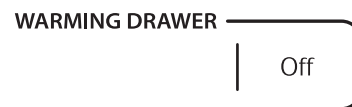

The Warming Drawer operates at temperatures of approximately 140°F (60°C) (Low), 160°F (71°C) (Medium), 180°F (82°C) (High).

Slow Cook

! WARNING

Food Poisoning Hazard

Do not let food sit for more than one hour before or after cooking.

Doing so can result in food poisoning or sickness.

The Slow Cook function in the warming drawer cooks food slowly at a low temperature over a long period of time, similar to a countertop slow cooker.

There are 2 settings: Hi and Lo. Guidelines for cooking times are 4 to 5 hours for Hi and 8 to 10 hours for Lo. Smaller quantities of food may require less time, while larger quantities may require more time.

When slow cooking, use oven-safe cookware. Before slow cooking, thaw frozen foods completely. Cover foods with a lid or aluminum foil to keep the food moist.

IMPORTANT: Brown roasts thoroughly before starting to slow cook.

Before using the warming drawer, wash the bottom of the drawer with soap and water. See "General Cleaning" section.

To Use:

1. Press WARMING DRAWER SLOW COOK to select the Slow Cook function at the Low setting.



2. To select a higher temperature setting, press WARMING DRAWER SLOW COOK a second time for the High setting.
3. Place the food(s) in the warming drawer.
4. Press START to begin heating the warming drawer.
5. Press WARMING DRAWER OFF to turn off the heating element.

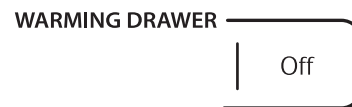

RANGE CARE



Clean Cycle

AquaLift™ Technology is an innovative cleaning solution that utilizes heat and water to release baked-on spills from the oven in less than 1 hour. This new cleaning technology is a low-heat, odor-free alternative to traditional self-cleaning options.

Allow the oven to cool to room temperature before using the Clean cycle. If your oven cavity is above 200°F (93°C), "OVEN COOLING" will appear in the display, and the Clean cycle will not be activated until the oven cavity cools down.

To Clean:

1. Remove all racks and accessories from the oven cavity and wipe excess soil. Use a plastic scraper to remove easily-removed soils.

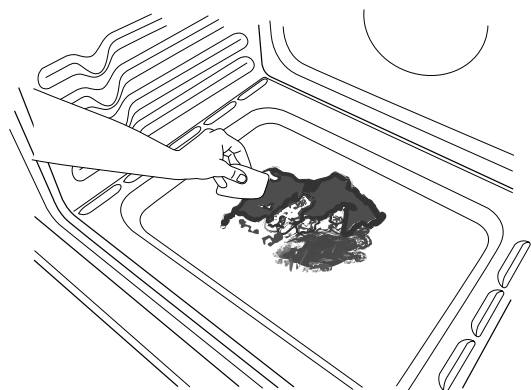

2. Pour 2 cups (16 oz [500 mL]) of distilled or filtered water onto the bottom of the empty oven and close the oven door.

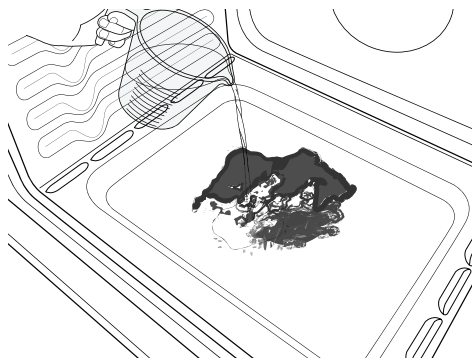

IMPORTANT: Do not use chemicals or other additives with the water. Do not open the oven door during the Clean cycle. The water on the oven bottom is hot.

3. Press CLEAN and then START on the oven control panel.
4. Allow 40 minutes for cleaning and cool down. A beep will sound when the Clean cycle is complete.

5. Press OFF at the end of the cycle. OFF may be pressed at any time to stop the Clean cycle.
6. Remove the residual water and loosened soils with a sponge or cloth immediately after the Clean cycle is complete. Much of the initial 2 cups (16 oz [500 mL]) of water will remain in the oven after the cycle is completed. If additional soils remain, leave a small amount of water in the oven bottom to assist with the cleaning.

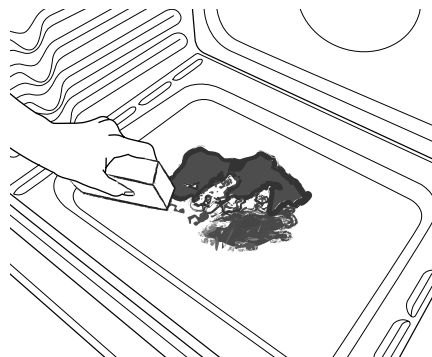

7. If any soils remain, remove them with a non-scratch scrubbing sponge or plastic scraper. Additional Clean cycles may be run to help remove the stubborn soils.

IMPORTANT: Do not use oven cleaners. The use of chemicals, including commercial oven cleaners or metal scouring pads, may cause permanent damage to the porcelain surface of the oven interior.

NOTES:

- The range should be level to ensure that the entire surface of the bottom of the oven cavity is covered by water at the beginning of the Clean cycle.
- For best results, use distilled or filtered water. Tap water may leave mineral deposits on the oven bottom.
- Before removing the residual water and loosened soils at the end of the Clean cycle, insert a cloth or paper towel between the lower edge of the oven door and the front frame to keep water from spilling onto the front of the range and the floor.
- Soil baked on through several cooking cycles will be more difficult to remove with the Clean cycle.
- Nonabrasive scrub sponges or eraser style cleaning pads (without cleaners) can be effective for cleaning the oven cavity walls, oven door and oven bottom for difficult soils. For best results, moisten the pads and sponges before use.
- Run an additional Clean cycle for stubborn soils.
- affresh® Kitchen and Appliance Cleaner and affresh® Cooktop Cleaner may be used to clean the oven bottom, walls and door when the oven has finished the cycle and returned to room temperature. If affresh® Cooktop Cleaner is used, wiping out the oven with distilled water is recommended as well. Refer to the "Accessories" section for information on ordering.
- Additional AquaLift™ Technology Cleaning Kits may be obtained by ordering Part Number W10423113RP. See the "Accessories" section for more information.
- For assistance with AquaLift™ Technology, call 1-877-258-0808, or visit our website at <http://whr.pl/aqualift>.

General Cleaning

IMPORTANT: Before cleaning, make sure all controls are off and the oven and cooktop are cool. Always follow label instructions on cleaning products. For additional information, you can visit the Frequently Asked Questions (FAQs) section of our website at www.kitchenaid.com.

Soap, water and a soft cloth or sponge are suggested first unless otherwise noted.

EXTERIOR PORCELAIN ENAMEL SURFACES (on some models)

Food spills containing acids, such as vinegar and tomato, should be cleaned as soon as the entire range is cool. These spills may affect the finish.

Cleaning Method:

- Glass cleaner, mild liquid cleaner or nonabrasive scrubbing pad:
Gently clean around the model and serial number plate because scrubbing may remove numbers.
- affresh® Kitchen and Appliance Cleaner Part Number W10355010 (not included):
See “Accessories” section for more information.

STAINLESS STEEL (on some models)

NOTE: To avoid damage to stainless steel surfaces, do not use soap-filled scouring pads, abrasive cleaners, Cooktop Cleaner, steel-wool pads, gritty washcloths or abrasive paper towels. Damage may occur to stainless steel surfaces, even with one-time or limited use.

Cleaning Method:

Rub in direction of grain to avoid damaging.

- affresh® Stainless Steel Cleaner Part Number W10355016:
See “Accessories” section for more information.
- Liquid detergent or all-purpose cleaner:
Rinse with clean water and dry with soft, lint-free cloth.

METALLIC PAINT (on some models)

Do not use abrasive cleaners, cleaners with bleach, rust removers, ammonia or sodium hydroxide (lye) because paint surface may stain.

CERAMIC GLASS

Cleaning Method:

Use affresh® Cooktop Cleaner Part Number W10355051 with Cooktop Scraper Part Number WA906B to clean and remove stains from the cooktop. Use Cooktop Protectant Part Number 31463A regularly to avoid stain buildup, pitting and scratching, while conditioning the cooktop for easier future cleaning. These can be ordered as accessories. See “Accessories” section for more information. The Cooktop Scraper uses razor blades. Store razor blades out of the reach of children.

Do not use steel wool, abrasive powder cleansers, chlorine bleach, rust remover or ammonia because damage may occur.

Light to moderate soil

- Can be cleaned with damp paper towels or sponge. Light stains should be addressed with cleaner and cleaning pad.

Sugary spills (jellies, candy, syrup)

- Clean with cooktop scraper and cooktop cleaner. Scrape off sugary spills while the cooktop is still warm. You may want to wear oven mitts while cleaning the cooktop.

Heavy soil, dark streaks, specks and discoloration

- Clean with Cooktop Cleaner or nonabrasive cleaner and cleaning pad.

Burned-on soil

- Clean with Cooktop Cleaner, Cleaning Pad and Cooktop Scraper.

Metal marks from aluminum and copper

- Clean with Cooktop Cleaner and Cleaning Pad as soon as cooktop has cooled down. The marks will not totally disappear, but after many cleanings they will become less noticeable.

Tiny scratches and abrasions

- Use Cooktop Cleaner and Cleaning Pad for scratches. Scratches and abrasions do not affect cooking performance, and after many cleanings they will become less noticeable.

CONTROL PANEL AND OVEN DOOR EXTERIOR

To avoid damage to the control panel, do not use abrasive cleaners, steel-wool pads, gritty washcloths or abrasive paper towels.

Cleaning Method:

- Glass cleaner and soft cloth or sponge:
Apply glass cleaner to soft cloth or sponge, not directly on panel.
- affresh® Kitchen and Appliance Cleaner Part Number W10355010 (not included):
See “Accessories” section for more information.

OVEN RACKS

Cleaning Method:

- Steel-wool pad
- For racks that have discolored and are harder to slide, a light coating of vegetable oil applied to the rack guides will help them slide.

STORAGE DRAWER OR WARMING DRAWER (on some models)

Check that storage drawer or warming drawer is cool and empty before cleaning.

Cleaning Method:

- Mild detergent

OVEN CAVITY

Use AquaLift™ Technology regularly to clean oven spills.

Do not use oven cleaners.

Food spills should be cleaned when oven cools. At high temperatures, foods react with porcelain and staining, etching, pitting or faint white spots can result.

Cleaning Method:

- Clean cycle: See “Clean Cycle” first.

Oven Light

The oven light is a standard 40-watt appliance bulb. Before replacing, make sure the oven and cooktop are cool and the control knobs are in the off position.

To Replace:

1. Unplug range or disconnect power.

2. Turn the glass bulb cover in the back of the oven counterclockwise to remove.
3. Turn bulb counterclockwise to remove from socket.
4. Replace bulb, then bulb cover by turning clockwise.
5. Plug in range or reconnect power.

TROUBLESHOOTING

First try the solutions suggested here or visit our website and reference FAQs (Frequently Asked Questions) to possibly avoid the cost of a service call.

www.kitchenaid.com

Operation

PROBLEM	POSSIBLE CAUSES	SOLUTIONS
Nothing will operate	Power supply cord is unplugged.	Plug into a grounded outlet.
	Household fuse is blown, or a circuit breaker is tripped.	Replace the fuse or reset the circuit breaker. If the problem continues, call an electrician.
Cooktop will not operate	The control knob is set incorrectly.	Touch the display area on the control panel to select a cooking surface before selecting a function.
	The cooktop control lockout is set.	See "Control Lock" in the "Cooktop Use" section.
	Cooktop is turned off.	The Power key was unintentionally touched. Press POWER again. Reset the cooktop.
Cooktop cooking results not what expected	Improper cookware being used	See "Cookware" section.
	Cooktop control set to incorrect heat level	See "Cooktop Controls" in the "Cooktop Use" section.
	Range is not level.	Level the range. See the Installation Instructions.
Oven will not operate	The electronic oven control was set incorrectly.	See "Electronic Oven Controls" section.
	Delay Start was set.	See "Cook Time" section.
	The oven control lockout is set.	See the control lock keypad feature in the "Feature Guide" section.
	The range is in Demo Mode.	Demo Mode will deactivate all heating elements. See "Demo Mode" in the "Electronic Oven Controls" section.
"FEATURE NOT AVAILABLE" is displayed when trying to use the Control Lock function.	A cooktop or oven function is active, including the timer or timed cooking features, or the oven is hot or a cooktop hot surface indicator is lit.	Ensure that all cooktop and oven functions are off, and that the cooktop and oven are cool. If this does not work, call for service. See cover for contact information.
Oven temperature too high or too low	Oven temperature calibration needs adjustment.	See "Oven Temperature Control" in the "Electronic Oven Controls" section.
Oven indicator lights flash	Needs service (oven indicator lights are flashing).	See "Control Display" in the "Electronic Oven Controls" section. If the indicator light(s) keeps flashing, call for service. See cover for contact information.
Oven control displays messages	Power failure (display shows flashing time)	Clear the display. On some models, reset the clock, if needed. See "Clock" keypad feature in the "Feature Guide" section.
	Error code (display shows letter followed by number)	Press the OFF keypad to clear the display. See "Control Display" in the "Electronic Oven Controls" section. If it reappears, call for service. See cover for contact information.
Cooktop display shows messages	Improper pan being used ("No Pan" lights up in the display when you place a saucepan on an induction surface cooking area)	See "Pan Detection" in the "Cooktop Use" section. Check that the saucepan is ferromagnetic. Check that the diameter of the saucepan is large enough. Center the saucepan on the surface cooking area. Allow the saucepan to cool down in the event that it has become hot when used. Switch the surface cooking area off, then on again. If the display still does not light up, turn power off at the circuit breaker. Wait 20 seconds and turn power back on.
	Long cooking time (performance boost function display flashing and switching off)	The Performance boost function operates the surface cooking area with the most power. During long cooking times, it is possible that the function will switch the surface cooking area off to keep the cooktop from overheating. You can continue to use the cooktop if the display is not flashing.
	Error code (display flashing "Er" and numbers)	If an "Er" and a series of numbers appear in the display panel, turn power off at the circuit breaker. Turn on again. If problem continues, call customer service. See the cover for contact information.

PROBLEM	POSSIBLE CAUSES	SOLUTIONS
Is the display flashing “F” or “C” and numbers? If “F” or “C” and a number are alternately flashing on the display, refer to the following for possible solutions:		
Cooktop has turned off and is beeping every 10 seconds.	An object, liquids or soils are putting pressure on the control panel.	Thoroughly wipe or remove any object on touch keys.
F42, F43	The power voltage is too low or too high.	Turn off the cooktop. Wait 5 seconds, then turn it back on. If this continues, contact a qualified electrician.
C81, C82, C83	The surface cooking area has overheated.	The surface cooking area automatic shutoff was activated. Wait 5 minutes for it to cool down, then turn it back on.
F12, F21, F25, F36, F37, F40, F47, F56, F58, 560, F61, F62, F63, F64		Call for service. See the cover for contact information.
Mineral deposits are left on the oven bottom after the Clean cycle	Tap water was used in the Clean cycle.	Use distilled or filtered water in the Clean cycle. To remove deposits, use a cloth soaked with vinegar. Then use a cloth dampened with water to thoroughly remove any vinegar residue.
	Range is not level.	Mineral deposits will collect on dry areas of the oven bottom during the Clean cycle. Level the range. See the Installation Instructions. To remove deposits, use a cloth soaked with vinegar. Then use a cloth dampened with water to thoroughly remove any vinegar residue.
Oven cooking results not what expected	Range is not level.	Level the range. See the Installation Instructions.
	The temperature set was incorrect.	Double-check the recipe in a reliable cookbook.
	Oven temperature is calibrated incorrectly.	See “Oven Temperature Control” in the “Electronic Oven Controls” section.
	Oven was not preheated.	See “Baking and Roasting” section.
	Racks were positioned improperly.	See “Positioning Racks and Bakeware” section.
	Not enough air circulation around bakeware	See “Positioning Racks and Bakeware” section.
	Batter distributed unevenly in pan	Check that batter is level in the pan.
	Darker browning of food caused by dull or dark bakeware	Lower oven temperature 25°F (15°C), or move rack to a higher position in the oven.
	Lighter browning of food caused by shiny or light colored bakeware	Move rack to a lower position in the oven.
	Incorrect length of cooking time was used.	Adjust cooking time.
	Oven door was not closed.	Be sure that the bakeware does not keep the door from closing.
	Oven door was opened during cooking.	Oven peeking releases oven heat and can result in longer cooking times.
	Rack is too close to bake burner, making baked items too brown on bottom.	Move rack to higher position in the oven.
	Pie crusts browning too quickly	Use aluminum foil to cover the edge of the crust and/or reduce baking temperature.
	Temperature scale was changed from Fahrenheit to Celsius.	Foods are overdone or burnt even at low temperatures. See “Fahrenheit and Celsius” in the “Electronic Oven Controls” section.

Noises

PROBLEM	POSSIBLE CAUSES	SOLUTIONS
Operational cooktop sounds The following are some normal sounds with the explanations.	These sounds are normal operational noises.	
Low humming or clicking	This occurs when cooking at high power. The cause of this is the amount of energy that is transmitted from the appliance to the cookware.	This sound will quiet or go away when the power is turned down.
Crackling	Cookware is used that consists of different materials. The noise is caused by vibrations in the joint faces between the different layers.	The sound may change depending on the amount and type of food being cooked.
Fan noise	The electronics require a controlled temperature in order to function reliably.	The cooktop is fitted with a fan that runs at various speeds according to the temperature detected. The fan may also continue to run even after the cooktop has been switched off, if the temperature it detects is too high.

ACCESSORIES

For accessories, you can visit our website at www.kitchenaid.com/cookingaccessories.

Cooktop Care Kit

(ceramic glass models)
(includes cleaner, protectant, scraper, and applicator pads)
Order Part Number 31605

Cooktop Protectant

(ceramic glass models)
Order Part Number 31463A

affresh® Stainless Steel Cleaning Wipes

(stainless steel models)
Order Part Number W10355049

affresh® Cooktop Cleaner

(ceramic glass models)
Order Part Number W10355051

affresh® Stainless Steel Cleaner

(stainless steel models)
Order Part Number W10355016

affresh® Kitchen and Appliance Cleaner

Order Part Number W10355010

AquaLift™ Technology Oven Cleaning Kit

Order Part Number W10423113RP

Cooktop Scraper

(ceramic glass models)
Order Part Number WA906B

Granite Cleaner and Polish

Order Part Number W10275756

Gas Grate and Drip Pan Cleaner

Order Part Number 31617A

Standard Flat Oven Rack

Order Part Number W10179196

Split Oven Rack

Order Part Number W10205524

Max Capacity Oven Rack

Order Part Number W10289145

Porcelain Broiler Pan and Grid

Order Part Number 4396923

Premium Broil Pan and Roasting Rack

Order Part Number W10123240
www.kitchenaid.com/broilerpan

KITCHENAID® ELECTRIC RANGE WARRANTY

LIMITED WARRANTY

For one year from the date of purchase, when this major appliance is operated and maintained according to instructions attached to or furnished with the product, KitchenAid brand of Whirlpool Corporation or Whirlpool Canada LP (hereafter "KitchenAid") will pay for Factory Specified Parts and repair labor to correct defects in materials or workmanship. Service must be provided by a KitchenAid designated service company. This limited warranty is valid only in the United States or Canada and applies only when the major appliance is used in the country in which it was purchased. Outside the 50 United States and Canada, this limited warranty does not apply. Proof of original purchase date is required to obtain service under this limited warranty.

SECOND THROUGH FIFTH YEAR LIMITED WARRANTY ON CERTAIN COMPONENT PARTS

In the second through fifth years from the date of purchase, when this appliance is operated and maintained according to instructions attached to or furnished with the product, KitchenAid will pay for Factory Specified Parts for the following components if defective in materials or workmanship:

- Electric element
 - Solid state touch control system parts
 - Any cracking of the rubber seal between the ceramic glass cooktop and porcelain edge
 - Any cracking due to thermal shock of the ceramic glass cooktop
 - Surface unit elements
-

ITEMS EXCLUDED FROM WARRANTY

This limited warranty does not cover:

1. Service calls to correct the installation of your major appliance, to instruct you on how to use your major appliance, to replace or repair house fuses, or to correct house wiring or plumbing.
2. Service calls to repair or replace appliance light bulbs, air filters or water filters. Consumable parts are excluded from warranty coverage.
3. Repairs when your major appliance is used for other than normal, single-family household use or when it is used in a manner that is contrary to published user or operator instructions and/or installation instructions.
4. Damage resulting from accident, alteration, misuse, abuse, fire, flood, acts of God, improper installation, installation not in accordance with electrical or plumbing codes, or use of consumables or cleaning products not approved by KitchenAid.
5. Cosmetic damage, including scratches, dents, chips or other damage to the finish of your major appliance, unless such damage results from defects in materials or workmanship and is reported to KitchenAid within 30 days from the date of purchase.
6. Costs associated with the removal from your home of your major appliance for repairs. This major appliance is designed to be repaired in the home and only in-home service is covered by this warranty.
7. Repairs to parts or systems resulting from unauthorized modifications made to the appliance.
8. Expenses for travel and transportation for product service if your major appliance is located in a remote area where service by an authorized KitchenAid servicer is not available.
9. The removal and reinstallation of your major appliance if it is installed in an inaccessible location or is not installed in accordance with published installation instructions.
10. Major appliances with original model/serial numbers that have been removed, altered or cannot be easily determined. This warranty is void if the factory applied serial number has been altered or removed from your major appliance.

The cost of repair or replacement under these excluded circumstances shall be borne by the customer.

DISCLAIMER OF IMPLIED WARRANTIES; LIMITATION OF REMEDIES

CUSTOMER'S SOLE AND EXCLUSIVE REMEDY UNDER THIS LIMITED WARRANTY SHALL BE PRODUCT REPAIR AS PROVIDED HEREIN. IMPLIED WARRANTIES, INCLUDING WARRANTIES OF MERCHANTABILITY OR FITNESS FOR A PARTICULAR PURPOSE, ARE LIMITED TO ONE YEAR OR THE SHORTEST PERIOD ALLOWED BY LAW. KITCHENAID SHALL NOT BE LIABLE FOR INCIDENTAL OR CONSEQUENTIAL DAMAGES. SOME STATES AND PROVINCES DO NOT ALLOW THE EXCLUSION OR LIMITATION OF INCIDENTAL OR CONSEQUENTIAL DAMAGES, OR LIMITATIONS ON THE DURATION OF IMPLIED WARRANTIES OF MERCHANTABILITY OR FITNESS, SO THESE EXCLUSIONS OR LIMITATIONS MAY NOT APPLY TO YOU. THIS WARRANTY GIVES YOU SPECIFIC LEGAL RIGHTS, AND YOU MAY ALSO HAVE OTHER RIGHTS WHICH VARY FROM STATE TO STATE OR PROVINCE TO PROVINCE.

If outside the 50 United States and Canada, contact your authorized KitchenAid dealer to determine if another warranty applies. 9/07

For additional product information, in the U.S.A., visit **www.kitchenaid.com**.

If you do not have access to the Internet and you need assistance using your product or you would like to schedule service, you may contact KitchenAid at the number below.

Have your complete model number ready. You can find your model number and serial number on the label, located on the oven frame behind the top right side of the oven door.

For assistance or service in the U.S.A., call 1-800-422-1230.

If you need further assistance, you can write to KitchenAid with any questions or concerns at the address below:

KitchenAid Brand Home Appliances
Customer eXperience Center
553 Benson Road
Benton Harbor, MI 49022-2692

Please include a daytime phone number in your correspondence.

Please keep this User Instructions and model number information for future reference.

