



# BUILT-IN ELECTRIC CONVECTION OVEN

## Use & Care Guide

For questions about features, operation/performance, parts accessories or service, call: **1-800-422-1230**  
In Canada, call for assistance **1-800-461-5681**, for installation and service, call: **1-800-807-6777** or visit our website at...  
[www.kitchenaid.com](http://www.kitchenaid.com) or [www.KitchenAid.ca](http://www.KitchenAid.ca)

Table of Contents..... 2



<b>Models</b>	<b>KEBC107</b>	<b>KEBC177</b>	<b>KEBC247</b>	<b>KEBC278</b>	<b>YKEBC107</b>	<b>YKEBC208</b>
	<b>KEBC147</b>	<b>KEBC208</b>	<b>KEBC277</b>	<b>KEBS207</b>	<b>YKEBC177</b>	<b>YKEBC278</b>

---

# TABLE OF CONTENTS

<b>OVEN SAFETY</b> .....	<b>3</b>
<b>PARTS AND FEATURES</b> .....	<b>5</b>
<b>ELECTRONIC OVEN CONTROL</b> .....	<b>6</b>
Displays .....	6
Start .....	6
Lower Oven Cancel / Off, Upper Oven Cancel / Off and Cancel Off.....	6
Clock .....	6
Tones.....	7
Fahrenheit and Celsius.....	7
Timer.....	7
Control Lock.....	7
Oven Temperature Control .....	8
<b>OVEN USE</b> .....	<b>8</b>
Aluminum Foil.....	8
Positioning Racks and Bakeware .....	8
Bakeware.....	9
Oven Vent(s) .....	9
Meat Thermometer.....	9
Sabbath Mode.....	10
Baking and Roasting .....	11
Maxi and Econo Broiling.....	12
Convection Cooking.....	13
Convection Bake.....	13
Convection Roast.....	13
Convection Broil.....	15
Convect Full Meal .....	15
EasyConvect™ Conversion .....	16
Dehydrating .....	17
Proofing Bread .....	17
Temperature Probe .....	17
Timed Cooking.....	19
<b>OVEN CARE</b> .....	<b>20</b>
Self-Cleaning Cycle.....	20
General Cleaning.....	21
Oven Lights .....	21
Oven Door .....	22
<b>TROUBLESHOOTING</b> .....	<b>22</b>
<b>ASSISTANCE OR SERVICE</b> .....	<b>23</b>
In the U.S.A. ....	23
In Canada .....	23
<b>WARRANTY</b> .....	<b>24</b>

# OVEN SAFETY

## Your safety and the safety of others are very important.

We have provided many important safety messages in this manual and on your appliance. Always read and obey all safety messages.



This is the safety alert symbol.

This symbol alerts you to potential hazards that can kill or hurt you and others.

All safety messages will follow the safety alert symbol and either the word “DANGER” or “WARNING.” These words mean:

**! DANGER**

**You can be killed or seriously injured if you don't immediately follow instructions.**

**! WARNING**

**You can be killed or seriously injured if you don't follow instructions.**

All safety messages will tell you what the potential hazard is, tell you how to reduce the chance of injury, and tell you what can happen if the instructions are not followed.

## IMPORTANT SAFETY INSTRUCTIONS

**WARNING:** To reduce the risk of fire, electrical shock, injury to persons, or damage when using the oven, follow basic precautions, including the following:

- Proper Installation – Be sure the oven is properly installed and grounded by a qualified technician.
- Never Use the Oven for Warming or Heating the Room.
- Do Not Leave Children Alone – Children should not be left alone or unattended in area where oven is in use. They should never be allowed to sit or stand on any part of the oven.
- Wear Proper Apparel – Loose-fitting or hanging garments should never be worn while using the oven.
- User Servicing – Do not repair or replace any part of the oven unless specifically recommended in the manual. All other servicing should be referred to a qualified technician.
- Storage in Oven – Flammable materials should not be stored in an oven.
- Do Not Use Water on Grease Fires – Smother fire or flame or use dry chemical or foam-type extinguisher.
- Use Only Dry Potholders – Moist or damp potholders on hot surfaces may result in burns from steam. Do not let potholder touch hot heating elements. Do not use a towel or other bulky cloth.
- Use Care When Opening Door – Let hot air or steam escape before removing or replacing food.
- Do Not Heat Unopened Food Containers – Build-up of pressure may cause container to burst and result in injury.
- Keep Oven Vent Ducts Unobstructed.
- Placement of Oven Racks – Always place oven racks in desired location while oven is cool. If rack must be moved while oven is hot, do not let potholder contact hot heating element in oven.
- DO NOT TOUCH HEATING ELEMENTS OR INTERIOR SURFACES OF OVEN – Heating elements may be hot even though they are dark in color. Interior surfaces of an oven become hot enough to cause burns. During and after use, do not touch, or let clothing or other flammable materials contact heating elements or interior surfaces of oven until they have had sufficient time to cool. Other surfaces of the oven may become hot enough to cause burns – among these surfaces are oven vent openings and surfaces near these openings, oven doors, and windows of oven doors.

**SAVE THESE INSTRUCTIONS**

## IMPORTANT SAFETY INSTRUCTIONS

### For self-cleaning ovens:

- Do Not Clean Door Gasket – The door gasket is essential for a good seal. Care should be taken not to rub, damage, or move the gasket.
- Do Not Use Oven Cleaners – No commercial oven cleaner or oven liner protective coating of any kind should be used in or around any part of the oven.
- Clean Only Parts Listed in Manual.
- Before Self-Cleaning the Oven – Remove broiler pan and other utensils.

## SAVE THESE INSTRUCTIONS

The California Safe Drinking Water and Toxic Enforcement Act requires the Governor of California to publish a list of substances known to the State of California to cause cancer, birth defects, or other reproductive harm, and requires businesses to warn of potential exposure to such substances.

**WARNING:** This product contains a chemical known to the State of California to cause cancer, birth defects, or other reproductive harm.

This appliance can cause low-level exposure to some of the substances listed, including benzene, formaldehyde, carbon monoxide, and toluene.

# PARTS AND FEATURES

This manual covers different models. The oven you have purchased may have some or all of the items listed. The locations and appearances of the features shown here may not match your model

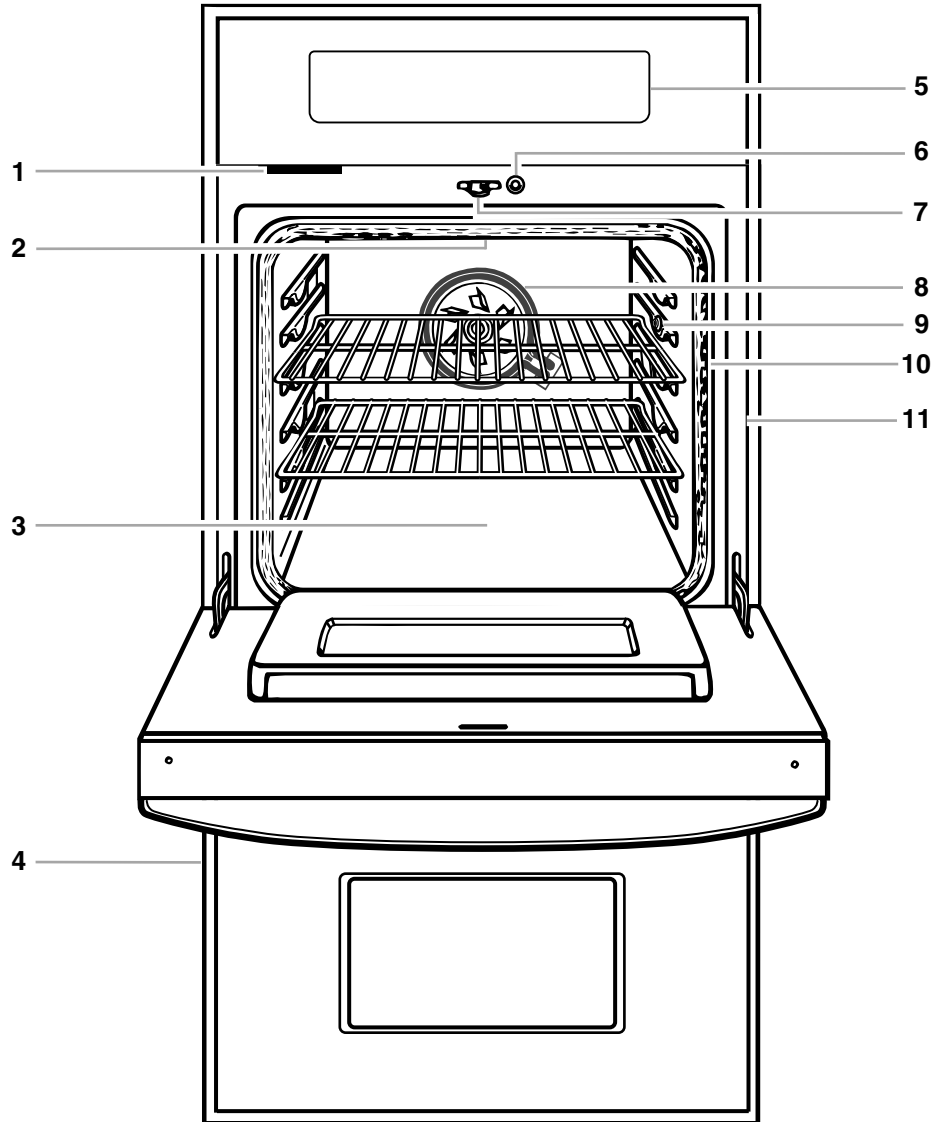

1. Oven Vent
2. Broil Elements (not shown)
3. CleanBake™ Bake element (hidden in floor panel)
4. Lower Oven (on double oven models)
5. Electronic Oven Control
6. Automatic Oven Light Switch
7. Oven Lock Latch

8. T.H.E.™ (Third Hidden Element) Convection Element and Fan (in back panel)
9. Temperature Probe Jack (upper and single ovens only)
10. Gasket
11. Model and Serial Number Plate (on right mounting rail)

**Parts and Features not shown**  
Oven Light  
Third Oven Rack  
Broiler Pan and Grid  
Roasting Rack  
Temperature Probe

# ELECTRONIC OVEN CONTROL

This manual covers different models. The oven you have purchased may have some or all of the items listed. The locations and appearances of the items shown here may not match your model.

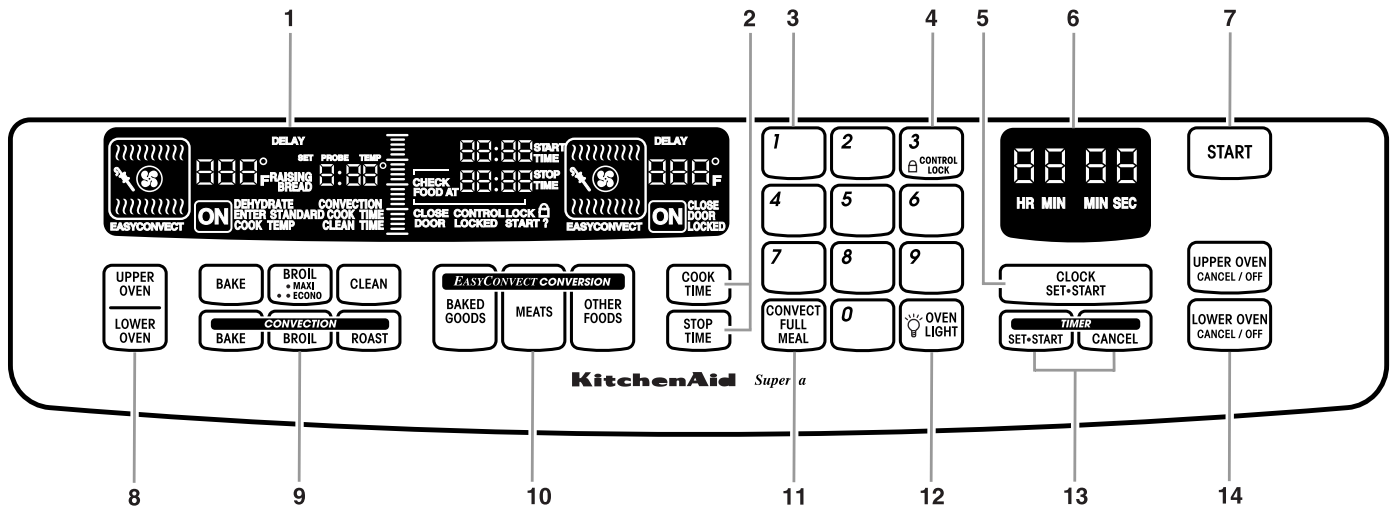

- |                               |   |   |
|-------------------------------|---|---|
| 1. Oven Display               | 7. Start  | 12. Oven Light  |
| 2. Timed Cooking              | 8. Upper or Lower Oven Selectors<br>(double oven models only) | 13. Timer   |
| 3. Number Pads                | 9. Oven Option Selectors                                      | 14. Upper and Lower Oven Cancel / Off<br>(double oven models)<br>Cancel Off<br>(single oven models) |
| 4. Control Lock               | 10. EasyConvect™ Conversion                                   |   |
| 5. Clock                      | 11. Convect Full Meal   |   |
| 6. Time of Day, Timer Display |   |   |

## Displays

When power is first supplied to the appliance, everything on the displays will light up for 5 seconds. Then, "PF" will appear on the oven display and a time of day will appear on the Time of Day display. Press LOWER OVEN CANCEL / OFF, UPPER OVEN CANCEL / OFF or CANCEL OFF to clear the oven display.

Any other time "PF" appears, a power failure occurred. Press LOWER OVEN CANCEL / OFF, UPPER OVEN CANCEL / OFF or CANCEL OFF and reset the clock if needed.

### Oven Display

When the oven(s) are in use, this display shows the oven temperature, heat source(s) and start time. On double oven models, this display will also show which oven is being set. The left cavity symbol represents the upper oven, and the right cavity symbol represents the lower oven.

In addition, during Timed Cooking, this display shows a vertical bar and time countdown and the stop time (if entered).

If "Err" appears on the oven display, an invalid pad was pressed. Press LOWER OVEN CANCEL / OFF, UPPER OVEN CANCEL / OFF or CANCEL OFF and retry your entry.

When the ovens are not in use, this display is blank.

### Time of Day, Timer Display

This display shows the time of day or Timer countdown.

## Start

The START pad begins all oven functions except the Timer, Control Lock and Sabbath Mode. If not pressed within 5 seconds after pressing a pad, "START?" will appear on the oven display as a reminder. Depending on your model, if not pressed within 4 or 5 minutes after pressing a pad, the oven display will return to inactive mode (blank) and the programmed function will be canceled.

## Lower Oven Cancel / Off, Upper Oven Cancel / Off and Cancel Off

The LOWER OVEN CANCEL / OFF, UPPER OVEN CANCEL / OFF and CANCEL OFF pads stop their respective oven functions except for the Clock, Timer, Control Lock and Sabbath Mode. The cooling fan may continue to operate even after an oven function has been canceled, depending on the oven temperature.

## Clock

This is a 12-hour clock and does not show a.m. or p.m.

### To Set:

Before setting, make sure the oven(s), Timer and Timed Cooking are off. On some models, the clock can be set when the oven(s) are on, however the start time will disappear.

1. Press CLOCK SET/START.
2. Press the number pads to set the time of day.
3. Press CLOCK SET/START or START.

**To Remove/Return Time of Day from Display:** Press and hold CLOCK SET/START for 5 seconds. Repeat to re-display. The time should not have to be reset.

---

## Tones

Tones are audible signals, indicating the following:

### One tone

- Valid pad press
- Oven is preheated
- Function has been entered

### Three tones

- Invalid pad press

### Four tones

- End-of-cycle
- Reminder, repeating each minute after the end-of-cycle tones

---

### Tone Volume

---

The volume is preset at high, but can be changed to low.

**To Change:** Press and hold the number pad “7” for 5 seconds. On some models, a tone will sound and “Snd Lo” will appear on the oven display for 3 seconds. If “Snd Lo” remains on the display, press CANCEL to remove. Repeat to change back to “Snd HI.”

---

### All Tones (double oven models)

---

All of the above tones are preset on, but can be turned off.

**To Turn Off/On:** Press and hold STOP TIME for 5 seconds. On some models, a tone will sound and “Snd Lo” will appear on the oven display for 3 seconds. If “Snd Lo” remains on the display, press CANCEL to clear. Repeat to change back to “Snd HI.”

---

### Pad Press Tones (single oven models)

---

The single tones signaling a valid pad press are preset on, but can be turned off.

**To Turn Off/On:** Press and hold STOP TIME for 5 seconds. On some models, a tone will sound and “Snd off” will appear on the oven display for 3 seconds. If “Snd off” remains on the display, press CANCEL to clear. Repeat to change back to “Snd on.”

---

### End-of-Cycle and Reminder Tones

---

The Timer and Timed Cooking end-of-cycle and reminder tones are preset on, but can be turned off. On some models, if all tones have been turned off, the end-of-cycle and reminder tones cannot be independently turned on.

**To Turn Tones Off/On:** Depending on your model, press and hold COOK TIME until a tone sounds and the oven display returns to inactive mode (blank). If “EOC OFF” appears on your display, press CANCEL to clear. Repeat to turn back on.

---

### Reminder Tones Only

---

The Minute Timer and Timed Cooking reminder tones are preset on, but can be turned off. However, on double oven models, if all tones have been turned off, the reminder tones cannot be independently turned on.

**To Turn Tones Off/On:** Press and hold TIMER SET/START until a tone sounds. On some models, the oven display will display “NA9 OFF.” To remove this from the display, press CANCEL. Repeat to turn back on.

---

## Fahrenheit and Celsius

The temperature is preset in Fahrenheit, however it can be changed to Celsius.

**To Change:** Press and hold BROIL/MAXI//ECONO for 5 seconds. Depending on your model, a tone will sound and “C°” or “C” will appear on the display for 3 seconds, or until you press CANCEL. Repeat to change back to Fahrenheit.

When in Fahrenheit, “°F” follows the oven temperature.

When in Celsius, only “°” follows the oven temperature.

---

## Timer

The Timer can be set in minutes and seconds or hours and minutes and counts down the set time. It does not start or stop the oven.

### To Set:

1. Press TIMER SET/START.

Press again to switch between MIN/SEC and HR/MIN.

If no action is taken within a certain amount of time (between one minute and four minutes depending on your model), the display will return to the time of day mode.

2. Press the number pads to set the length of time.
3. Press TIMER SET/START or START.

If not pressed within a certain amount of time (between 5 seconds and 4 minutes depending on your model), the display will return to the time of day mode and the programmed function will be canceled.

When the set time ends, if enabled, end-of-cycle tones will sound, then reminder tones will sound every minute.

4. Press TIMER CANCEL anytime to cancel the Timer or stop the reminder tones.

Remember, if a Cancel Off pad is pressed, the respective oven will turn off.

The time can be reset during countdown by repeating the above steps.

---

## Control Lock

The Control Lock shuts down the control panel pads to prevent unintended use of the oven(s). The Control Lock will remain set after a power failure, if set before the power failure. The only time it is not available is during the Sabbath Mode or Self-Clean cycle.

When the control is locked, the TIMER SET/START, TIMER CANCEL, OVEN LIGHT and CANCEL OFF, UPPER OVEN CANCEL/OFF or LOWER OVEN CANCEL/OFF pads will function. On double oven models, CLOCK SET•START will also function.

The Control Lock is preset unlocked, but can be locked.

**To Lock/Unlock Control:** Press and hold the number pad 3 CONTROL LOCK for about 3 seconds until “CONTROL LOCK” and a picture of a lock appear on the display. Repeat to unlock and remove “CONTROL LOCK” from the display.

## Oven Temperature Control

**IMPORTANT:** Do not use a thermometer to measure oven temperature because opening the oven door and element or burner cycling may give incorrect readings.

The oven(s) provide accurate temperatures; however, they may cook faster or slower than your previous oven, so the temperature calibration can be adjusted. It can be changed in Fahrenheit or Celsius.

A minus sign means the oven will be cooler by the displayed amount. No sign means the oven will be warmer by the displayed amount. Use the following chart as a guide.

ADJUSTMENT °F (ADJUSTMENT °C)	COOKS FOOD
5° to 10°F (3° to 6°C)	...a little more
15° to 20°F (9° to 12°C)	...moderately more
25° to 35°F (15° to 21°C)	...much more
-5° to -10°F (-3° to -6°C)	...a little less
-15° to -20°F (-9° to -12°C)	...moderately less
-25° to -35°F (-15° to -21°C)	...much less

### To Adjust Oven Temperature Calibration:

1. Press and hold BAKE until the oven display shows the current calibration, for example, "0°F CAL COOK TEMP," if not yet adjusted, or about 5 seconds.
2. On double ovens only, press UPPER OVEN or LOWER OVEN to select oven.  
Each oven calibration can be independently set.
3. Press BAKE to increase and BROIL/MAXI//ECONO to decrease the temperature in 5°F (3°C) amounts. The adjustment can be set between 35°F (21°C) and -35°F (-21°C).
4. Press START.

## OVEN USE

Odors and smoke are normal when the appliance is new. This happens the first time the oven is used or when the oven is heavily soiled.

During oven use, the heating elements will not remain on, but will cycle on and off throughout oven operation.

**IMPORTANT:** The health of some birds is extremely sensitive to the fumes given off. Exposure to the fumes may result in death to certain birds. Always move birds to another closed and well ventilated room.

## Aluminum Foil

**IMPORTANT:** Do not line the oven bottom with any type of foil, liners or cookware because permanent damage will occur to the oven bottom finish.

- Do not cover entire rack with foil because air must be able to move freely for best cooking results.
- To catch spills, place foil on rack below dish. Make sure foil is at least 1 in. (2.5 cm) larger than the dish and that it is turned up at the edges.
- Do not cover food with aluminum foil when convection cooking (on some models).

## Positioning Racks and Bakeware

**IMPORTANT:** Never place food or bakeware directly on the oven door or bottom. Permanent damage will occur to the porcelain finish.

### RACKS

Position racks before turning the oven on. Do not move racks with bakeware on them. Make sure racks are level. To move a rack, pull it out to the stop position, raise the front edge, then lift out. Use the following illustration and chart as a guide.

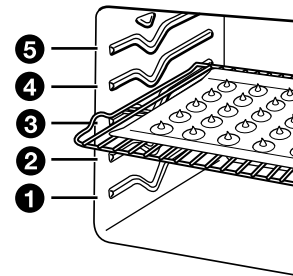

FOOD	RACK POSITION
Frozen pies, large roasts, turkeys, angel food cakes	1 or 2
Bundt cakes, most quick breads, yeast breads, casseroles, meats	2
Cookies, biscuits, muffins, cakes, non-frozen pies	2 or 3



## BAKEWARE

To cook food evenly, hot air must be able to circulate. Allow 2 in. (5 cm) of space around bakeware and oven walls. Use the following chart as a guide.

NUMBER OF PAN(S)	POSITION ON RACK
1	Center of rack.
2	Side by side or slightly staggered.
3 or 4	Opposite corners on each rack. Make sure that no bakeware piece is directly over another.

## Bakeware

The bakeware material affects cooking results. Follow manufacturer's recommendations and use the bakeware size recommended in the recipe. Use the following chart as a guide.

BAKEWARE/ RESULTS	RECOMMENDATIONS
<b>Light colored aluminum</b> <ul style="list-style-type: none"> <li>■ Light golden crusts</li> <li>■ Even browning</li> </ul>	<ul style="list-style-type: none"> <li>■ Use temperature and time recommended in recipe.</li> </ul>
<b>Dark aluminum and other bakeware with dark, dull and/or non-stick finish</b> <ul style="list-style-type: none"> <li>■ Brown, crisp crusts</li> </ul>	<ul style="list-style-type: none"> <li>■ May need to reduce baking temperatures 25°F (15°C).</li> <li>■ Use suggested baking time.</li> <li>■ For pies, breads and casseroles, use temperature recommended in recipe.</li> <li>■ Place rack in center of oven.</li> </ul>
<b>Insulated cookie sheets or baking pans</b> <ul style="list-style-type: none"> <li>■ Little or no bottom browning</li> </ul>	<ul style="list-style-type: none"> <li>■ Place in the bottom third of oven.</li> <li>■ May need to increase baking time.</li> </ul>
<b>Stainless steel</b> <ul style="list-style-type: none"> <li>■ Light, golden crusts</li> <li>■ Uneven browning</li> </ul>	<ul style="list-style-type: none"> <li>■ May need to increase baking time.</li> </ul>
<b>Stoneware</b> <ul style="list-style-type: none"> <li>■ Crisp crusts</li> </ul>	<ul style="list-style-type: none"> <li>■ Follow manufacturer's instructions.</li> </ul>
<b>Ovenproof glassware, ceramic glass or ceramic</b> <ul style="list-style-type: none"> <li>■ Brown, crisp crusts</li> </ul>	<ul style="list-style-type: none"> <li>■ May need to reduce baking temperatures 25°F (15°C).</li> </ul>

## Oven Vent(s)

### Single and Double Oven Models

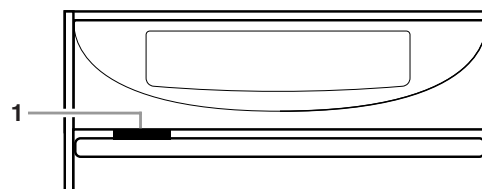

1. Oven vent

### Double Oven Models Only

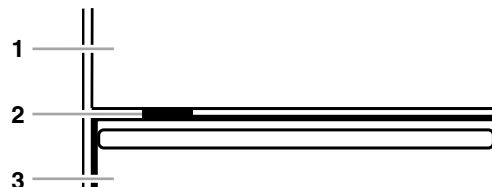

1. Upper oven  
2. Oven vent  
3. Lower oven

The oven vent(s) should not be blocked or covered since they allow the release of hot air and moisture from the oven. Doing so will cause poor air circulation, affecting cooking and cleaning results. Never set plastics, paper or other items that could melt or burn near the oven vent(s).

## Meat Thermometer

On models without a temperature probe, always rely on a meat thermometer to determine doneness of meat and poultry. The internal temperature, not appearance, is what counts. A meat thermometer is not supplied with this appliance.

- Insert the thermometer into the center of the thickest portion of the meat or inner thigh or breast of poultry. The tip of the thermometer should not touch fat, bone or gristle.
- After reading the thermometer once, push it into the meat ½ in. (1.25 cm) more and read again. If the temperature drops, cook the meat or poultry longer.
- Check all meat in two or three places.

---

## Sabbath Mode

The Sabbath Mode sets the oven to remain on in a bake setting until turned off. A timed Sabbath Mode can also be set to keep the oven on for only part of the Sabbath.

When the Sabbath Mode is set, the number pads are active. On single oven models, CANCEL OFF and START are also active. On double oven models, UPPER and LOWER OVEN and UPPER and LOWER OVEN CANCEL / OFF are also active. No tones will sound and the displays will not show messages or temperature changes. The heat sources icons will appear lit on the oven display throughout the Sabbath Mode.

When the oven door is opened or closed, the oven light will not turn on or off and the heating elements will not turn on or off immediately.

If a power failure occurs when the Sabbath Mode is set, the oven will return to the Sabbath Mode in an untimed bake with a temperature of 350°F (180°C).

### To Enable:

Before the Sabbath Mode can be regularly set, the oven(s) must first be enabled with a one time only set up. On double oven models, the following steps will enable both ovens.

1. On double ovens, open the upper oven door.  
On single ovens, open the oven door.
2. On double ovens, press UPPER OVEN CANCEL / OFF.  
On single ovens, press CANCEL OFF.
3. Press the number pads 7, 8, 9, 6, in this order.
4. Press START.  
“SAb On” will appear on the display.  
Press a Cancel/Off pad to clear the display.
5. Close oven door.

### To Disable:

The oven can be disabled of the ability to set the Sabbath Mode. When disabled the Sabbath Mode cannot be regularly set until re-enabled. On double oven models, the following steps will disable both ovens.

1. On double ovens, open the upper oven door.  
On single ovens, open the oven door.
2. On double ovens, press UPPER OVEN CANCEL / OFF.  
On single ovens press CANCEL OFF.
3. Press the number pads 7, 8, 9, 6, in this order.
4. Press UPPER OVEN CANCEL / OFF or CANCEL OFF.  
“SAb OFF” will appear on the display.  
Press a Cancel/Off pad to clear the display.
5. Close oven door.

### To Regularly Set, Untimed:

1. On double ovens only, press UPPER OVEN or LOWER OVEN.  
Each oven can be independently set.
2. Press OVEN LIGHT to desired option.
3. Press BAKE.  
Press the number pads to enter a temperature other than 350°F (180°C). The bake range can be set between 170°F and 500°F (75°C and 260°C).
4. Press START.
5. Press and hold the number pad 6 for about 5 seconds until “SAb ON” appears on the oven display.
6. To turn off the Sabbath Mode on the oven(s) any time, press and hold the number pad 6 for about 5 seconds until “SAb ON” disappears from the oven display.

### To Regularly Set, Timed:

## WARNING

### Food Poisoning Hazard

**Do not let food sit in oven more than one hour before or after cooking.**

**Doing so can result in food poisoning or sickness.**

1. On double ovens only, press UPPER OVEN or LOWER OVEN.  
Each oven can be independently set.
2. Press OVEN LIGHT to desired option.
3. Press BAKE.  
Press the number pads to enter a temperature other than 350°F (180°C). The bake range can be set between 170°F and 500°F (75°C and 260°C).
4. Press COOK TIME.
5. Press the number pads to enter the length of Sabbath Mode time, up to 9 hours 59 minutes.
6. On double ovens only, if setting the second oven, repeat steps 1 through 5.
7. Press START.  
The start time, stop time and vertical bar countdown will appear on the display.  
On double ovens, only the upper oven times will appear. When the upper oven stop time is reached, the display will show the lower oven times, if set for a longer time than the upper oven.  
Press and hold the number pad 6 for about 5 seconds until “SAb ON” appears on the oven display.
8. When the stop time is reached, the oven will automatically turn off.
9. To turn off the Sabbath Mode on the oven(s) any time, press and hold the number pad 6 for about 5 seconds until “SAb ON” disappears from the oven display.

## Temperature Change

The oven temperature can be changed when the oven(s) are in the Sabbath Mode. No tones will sound and the display will not change. The heating elements will not turn on or off for a random time, anywhere from 16 to 24 seconds, after START is pressed. It may take up to one-half hour for the oven to change temperature.

Number pads 1 through 0 represent temperatures.

Use the following chart as a guide.

**NUMBER PAD	OVEN TEMPERATURE
1	170°F (75°C)
2	200°F (95°C)
3	250°F (120°C)
4	275°F (135°C)
5	300°F (150°C)
*6	325°F (163°C)
7	350°F (180°C)
8	375°F (191°C)
9	400°F (204°C)
0	450°F (232°C)

\*\*The number pads must be pressed for at least 1 second.

\*Make sure when using the number pad 6, it is only pressed for one second since it can also turn off the Sabbath Mode.

### To Change Temperature:

1. On double ovens only, press UPPER OVEN or LOWER OVEN for at least 1 second.  
Each oven can be independently set.
2. Press the appropriate number pad from the chart for at least 1 second.
3. Press START for at least 1 second.

## Baking and Roasting

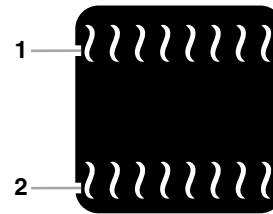

1. Broil heat
2. Bake heat

The CleanBake™ element is hidden under the floor of the oven, protected from spills and drips

During baking or roasting, the CleanBake™ and broil elements will cycle on and off in intervals to maintain the oven temperature.

If the oven door is opened during baking or roasting, the broil elements will turn off immediately and the CleanBake™ element will turn off in two minutes. They will come back on once the door is closed.

### To Bake or Roast:

Before baking or roasting, position racks according to the "Positioning Racks and Bakeware" section. When roasting, it is not necessary to wait for the oven to preheat before putting food in, unless recommended in the recipe.

1. On double ovens only, press UPPER OVEN or LOWER OVEN.  
The cavity symbol will flash indicating which oven was chosen. The left cavity symbol is the upper oven, the right cavity symbol is the lower oven.
2. Press BAKE.  
Press the number pads to enter a temperature other than 350°F (180°C). The bake range can be set between 170°F and 500°F (75°C and 260°C).
3. Press START.  
"Lo" will appear on the oven display if the actual oven temperature is under 170°F (75°C).  
When the actual oven temperature reaches 170°F (75°C), the oven display will show the temperature increasing in 5° increments.  
When the set temperature is reached, if on, one tone will sound.
4. Press CANCEL OFF, UPPER OVEN CANCEL / OFF or LOWER OVEN CANCEL / OFF when finished cooking.

## Maxi and Econo Broiling

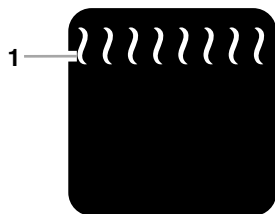

1. Broil heat

Broiling uses direct radiant heat to cook food.

During maxi broiling, both the inner and outer broil elements heat. During econo broiling, only the inner broil element heats. The element(s) cycle on and off in intervals to maintain the oven temperature.

If the oven door is opened during broiling, the broil element(s) will turn off immediately and come back on once the door is closed.

- Use only the broiler pan and grid provided with the appliance. It is designed to drain juices and help prevent spatter and smoke.
- For proper draining, do not cover the grid with foil. The bottom of the pan may be lined with aluminum foil for easier cleaning.
- Trim excess fat to reduce spattering. Slit the remaining fat on the edges to prevent curling.
- Pull out oven rack to stop position before turning or removing food. Use tongs to turn food to avoid the loss of juices. Very thin cuts of fish, poultry or meat may not need to be turned.
- After broiling, remove the pan from the oven when removing the food. Drippings will bake on the pan if left in the heated oven, making cleaning more difficult.

### To Broil:

Before broiling, position rack according to the Broiling Chart.

Changing the temperature when broiling allows more precise control when cooking. The lower the temperature, the slower the cooking. Thicker cuts and unevenly shaped pieces of meat, fish and poultry may cook better at lower broiling temperatures.

Position food on the grid on the broiler pan, then place it in the center of the oven rack with the longest side parallel to the door. It is not necessary to wait for the oven to preheat before putting food in, unless recommended in the recipe.

Close the door.

1. On double ovens only, press UPPER OVEN or LOWER OVEN. The cavity symbol will flash indicating which oven was chosen. The left cavity symbol is the upper oven, the right cavity symbol is the lower oven.
2. Press BROIL/MAXI//ECONO. Once for maxi, twice for econo. Press the number pads to enter a temperature other than 500°F (260°C). The broil range can be set between 170°F and 500°F (77°C and 260°C).
3. Press START. The set oven temperature will appear on the oven display until the oven is turned off.
4. Press CANCEL OFF, UPPER OVEN CANCEL / OFF or LOWER OVEN CANCEL / OFF when finished cooking.

## BROILING CHART

For best results, place food 3 in. (7 cm) or more from the broil elements, rack position 4 is recommended. For diagram, see the "Positioning Racks and Bakeware" section.

A temperature of 500°F (260°C) is recommended.

Times are guidelines only and may need to be adjusted for individual foods and tastes.

FOOD	COOK TIME (in minutes)
<b>Beef</b>	
Steak 1 in. to 1¼ in. (2.5 to 3 cm) thick	
medium-rare	12-14
medium	14-16
well done	18-22
<b>Pork</b>	
Pork chops 1 in. (2.5 cm) thick	
medium	16-18
<b>Lamb</b>	
Lamb chops 1 in. (2.5 cm) thick	
medium-rare	10-12
medium	11-13
<b>Ground Meats</b>	
*Ground beef, pork or lamb patties ¾ in. (2 cm) thick	
well-done	16-18
<b>Chicken</b>	
Chicken bone-in pieces (2 to 2½ in., 5 to 6.3 cm)	25-35
boneless pieces (4 oz., 113 g)	12-15
<b>Fish</b>	
Fish ½ in. to ¾ in. (1.25 to 2 cm) thick	6-9

\* Place up to 12 patties, equally spaced, on broiler grid.

---

## Convection Cooking

(on some models)

In a convection oven, the fan-circulated hot air continually distributes heat more evenly than the natural movement of air in a standard thermal oven. This movement of hot air maintains a consistent temperature throughout the oven, cooking foods more evenly, crisping surfaces while sealing in moisture and yielding crustier breads.

Most foods can be cooked by lowering cooking temperatures 25°F to 50°F (14°C to 28°C) and cooking time can be shortened by as much as 30 percent, especially for large turkeys and roasts.

- It is important not to cover foods so that surface areas remain exposed to the circulating air, allowing browning and crisping.
  - Keep heat loss to a minimum by only opening the oven door when necessary.
  - Choose cookie sheets without sides and roasting pans with lower sides to allow air to move freely around the food.
  - Test baked goods for doneness a few minutes before the minimum cooking time with an alternative method such as a toothpick.
  - Use a meat thermometer or the temperature probe to determine the doneness of meats and poultry. Check the temperature of pork and poultry in two or three places.
- 

## Convection Bake

(on some models)

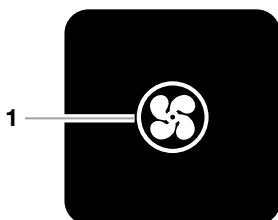

1. T.H.E.™ Convection element (hidden) and fan

The T.H.E.™ (Third Hidden Element) convection element is hidden in the rear panel of the oven cavity, and assisted by the convection fan, provides balanced, efficient heating.

Convection baking can be used for baking delicate cakes and pastries, as well as foods on multiple racks. It is helpful to stagger items on the racks to allow a more even flow of heat. If the oven is full, extra cooking time may be needed.

When cooking an oven meal with several different types of foods, be sure to select recipes that require similar temperatures. Cookware should sit in the oven with at least 1 in. (2.5 cm) of space between the cookware and the sides of the oven.

During convection baking preheat, the T.H.E.™ convection and broil elements and the CleanBake™ element all heat the oven cavity. After preheat, the T.H.E.™ convection element and the CleanBake™ element will cycle on and off in intervals to maintain oven temperature, while the fan constantly circulates the hot air.

If the oven door is opened during convection baking or preheating, the broil and T.H.E.™ convection element and fan will turn off immediately. They will come back on once the door is closed.

- Reduce recipe temperature 25°F (14°C). The cook time may need to be reduced also.

## To Convection Bake:

Before convection baking, position racks according to the “Positioning Racks and Bakeware” section. When using two racks, place on guides 2 and 4. When using three racks, place on guides 1, 3 and 5.

1. Press CONVECTION BAKE.

Press the number pads to enter a temperature other than 300°F (150°C). The convection bake range can be set between 170°F and 500°F (77°C and 260°C).

2. Press START.

“Lo” will appear on the oven display if the actual oven temperature is under 170°F (77°C).

When the actual oven temperature reaches 170°F (77°C), the oven display will show the oven temperature increasing in 5° increments.

When the set temperature is reached, if on, one tone will sound.

3. Press CANCEL OFF when finished cooking.
- 

## Convection Roast

(on some models)

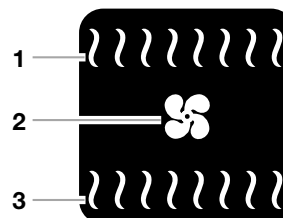

1. Broil heat  
2. Convection fan  
3. Bake heat

Convection roasting can be used for roasting meats and poultry, or for baking yeast breads and loaf cakes using a single rack. During convection roasting, the CleanBake™ and broil elements will cycle on and off in intervals to maintain oven temperature, while the fan constantly circulates the hot air.

If the oven door is opened during convection roasting, the broil element and fan will turn off immediately and the CleanBake™ element will turn off in 2 minutes. They will come back on once the door is closed.

- Reduce recipe temperature 25°F (14°C). The cook time may need to be reduced also.

### To Convection Roast:

Before convection roasting, position racks according to the “Positioning Racks and Bakeware” section. It is not necessary to wait for the oven to preheat before putting food in, unless recommended in the recipe.

Use the roasting rack on top of the broiler pan and grid. This holds the food above the grid and allows air to circulate completely around all surfaces.

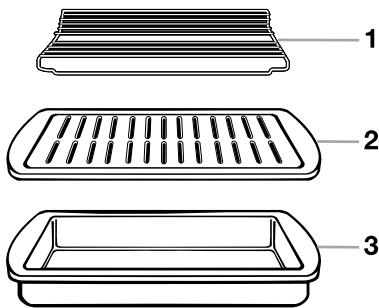

1. Roasting rack  
2. Broiler grid  
3. Broil pan

#### 1. Press CONVECTION ROAST.

Press the number pads to enter a temperature other than 300°F (150°C). The convection roast range can be set between 170°F and 500°F (77°C and 260°C).

#### 2. Press START.

“Lo” will appear on the oven display if the actual oven temperature is under 170°F (77°C).

When the actual oven temperature reaches 170°F (77°C), the oven display will show the oven temperature increasing in 5° increments.

When the set temperature is reached, if on, one tone will sound.

#### 3. Press CANCEL OFF when finished cooking.

### CONVECTION ROASTING CHART

Food/Rack Position	Cook Time (min. per 1 lb. [454 g])	Oven Temp.	Internal Food Temp.
<b>Beef, Rack Position 2</b>			
<b>Rib Roast</b>			
rare	20-25	300°F (145°C)	140°F (60°C)
medium	25-30		160°F (70°C)
well done	30-35		170°F (75°C)
<b>Rib Roast (boneless)</b>			
rare	22-25	300°F (145°C)	140°F (60°C)
medium	27-30		160°F (70°C)
well done	32-35		170°F (75°C)
<b>Rump, Sirloin Tip Roast</b>			
rare	20-25	300°F (145°C)	140°F (60°C)
medium	25-30		160°F (70°C)
well done	30-35		170°F (75°C)
<b>Meat Loaf</b>	20-25	325°F (160°C)	165°F (74°C)

Food/Rack Position	Cook Time (min. per 1 lb. [454 g])	Oven Temp.	Internal Food Temp.
<b>Veal, Rack Position 2</b>			
<b>Loin, Rib, Rump Roast</b>			
medium	25-35	325°F (160°C)	160°F (70°C)
well done	30-40		170°F (75°C)
<b>Pork, Rack Position 2</b>			
<b>Loin Roast (boneless)</b>	30-40	325°F (160°C)	160°F-170°F (71°C-75°C)
<b>Shoulder Roast</b>	35-40	325°F (160°C)	160°F-170°F (71°C-75°C)
<b>Ham, Rack Position 2</b>			
<b>Fresh (uncooked)</b>	25-35	300°F (145°C)	160°F (71°C)
<b>Fully Cooked</b>	15-20	300°F (145°C)	160°F (71°C)
<b>Lamb, Rack Position 2</b>			
<b>Leg, Shoulder Roast</b>			
medium	25-30	300°F (145°C)	160°F (70°C)
well done	30-35		170°F (75°C)
<b>*Chicken, Rack Position 2</b>			
<b>Whole</b>			
3-5 lbs. (1.5-2.2 kg)	20-25	325°F (160°C)	180°F (82°C)
5-7 lbs. (2.2-3.1 kg)	15-20	325°F (160°C)	180°F (82°C)
<b>*Turkey, Rack Positions 1 or 2</b>			
13 lbs. and under (5.85 kg)	10-15	300°F (145°C)	180°F (82°C)
Over 13 lbs. (5.85 kg)	10-12	300°F (145°C)	180°F (82°C)
<b>*Cornish Game Hens, Rack Position 2 or 3</b>			
1-1.5 lbs. (0.5-0.7 kg)	50-60	325°F (160°C)	180°F (82°C)

\*Do not stuff poultry when convection roasting.

## Convection Broil (on some models)

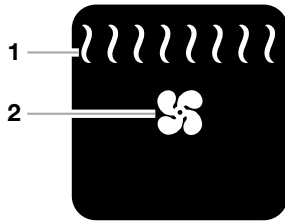

1. Broil heat
2. Convection Fan

During convection broiling, the broil elements will cycle on and off in intervals to maintain oven temperature, while the fan constantly circulates the hot air.

The temperature is preset at 450°F (232°C), but can be changed to a different temperature. Cooking times will vary depending on the rack position and temperature and may need to be adjusted.

If the oven door is opened during convection broiling, the broil elements and fan will turn off immediately. They will come back on once the door is closed.

### To Convection Broil:

Before convection broiling, see “Broil Maxi/Econo” section for general broiling guidelines. Position rack.

Allow the oven to preheat for 5 minutes. Position food on the unheated grid on the broiler pan, then place it in the center of the oven rack with the longest side parallel to the door.

Close the door.

1. Press CONVECTION BROIL.

Press the number pads to enter a temperature other than 450°F (232°C). The convection broil range can be set between 170°F and 500°F (77°C and 260°C).

2. Press START.

The set oven temperature will appear on the oven display until oven is turned off.

3. Press CANCEL OFF when finished cooking.

## Convect Full Meal (on some models)

Convect Full Meal lets you choose from eleven preset cooking cycles. A single pad includes an oven setting, an oven temperature, and a cook time or probe temperature. One pad is changeable to allow you to set your own cycle and save it for future use. Use the following chart as a guide.

PAD/ OVEN SETTING	OVEN TEMP	COOK TIME or PROBE TEMP	FOOD or MEAL
1 Convection Bake	325°F (163°C)	1 hr.	Meat Loaf, Baked Potatoes, Pineapple Upside Down Cake
2 Convection Roast	325°F (163°C)	1 hr. 30 min.	Turkey Breast, Stuffing Casserole, Peach Crisp

PAD/ OVEN SETTING	OVEN TEMP	COOK TIME or PROBE TEMP	FOOD or MEAL
3 Convection Roast	350°F (177°C)	40 min.	Stuffed Pork Chops, Baked Winter Squash, Bread Pudding
4 Convection Bake	375°F (191°C)	45 min.	Oven Fried Chicken Pieces, Scalloped Potatoes, Cherry Pie
5 Convection Bake	425°F (218°C)	20 min.	Baked Salmon Steaks, Roasted Vegetable Wedges, Biscuits
6 Convection Roast	325°F (163°C)	140°F (60°C)	Beef, rare
7 Convection Roast	325°F (163°C)	155°F (68°C)	Beef, medium or Pork
8 Convection Roast	325°F (163°C)	165°F (74°C)	Beef, well done
9 Convection Roast	300°F (149°C)	135°F (56°C)	Pot Roast (3 lbs [1.4 kg]) with vegetables
0 Convection Bake	325°F (163°C)	160°F (71°C)	Casseroles

### To Use:

Before using Convect Full Meal, place food in oven. If temperature probe is required, insert probe into food and plug probe into jack. See “Temperature Probe” section for diagram.

1. Press CONVECT FULL MEAL.

2. Press pad from chart.

For example, number pads 1 to 0 or CONVECT FULL MEAL.

3. Press START.

The start time, stop time, vertical bar countdown and minute time countdown will appear on the oven display. The stop time will not appear if not set in the changeable cycle.

When the cycle ends, “End” will appear in the oven display. If enabled, end-of-cycle tones will sound, then reminder tones will sound every minute.

4. Press CANCEL/OFF or open the oven door when finished cooking to clear the display.

### To Set Cycle:

Before setting a cycle, start with the meat or main dish temperature and cook time. Choose baked goods with an oven temperature similar to those of the meat or main dish. Temperatures ranging from plus or minus 25 to 50 degrees and cook times ranging from plus or minus 10 to 15 minutes are acceptable. Choose vegetables and fruits last.

1. Press CONVECT FULL MEAL.
2. Press any oven setting pad, for example BAKE.
3. Press number pads to enter oven temperature.
4. Press COOK TIME.
5. Press number pads to enter length of time to cook in hours and minutes  
or  
Press 0 to do untimed cooking.
6. Press CONVECT FULL MEAL to save  
or  
Press START to save and immediately begin cycle.

## EasyConvect™ Conversion

(single, upper and, on some models, lower oven)

Convection temperatures and times differ from those of standard cooking. The oven can automatically reduce standard recipe temperatures and times for convection cooking.

The conversion may not be exact because foods are grouped in general categories. To ensure optimal cooking results, the oven will prompt a food check at the end of a non-delayed cook time. Use the following chart as a guide.

SETTING	FOODS
BAKED GOODS	Biscuits, Breads: quick and yeast, Cakes: layer and angel food, Casseroles: including frozen entrées and soufflés, Cookies, Fish
MEATS	Baked potatoes, Chicken: whole and pieces, Meat loaf, Roasts: pork, beef and ham *Turkey and large poultry are not included because their cook time varies.
OTHER FOODS	Convenience foods: french fries, nuggets, fish sticks, pizza, Pies: fruit and custard

### To Use:

Before using Convection Temperature Conversion for BAKED GOODS and OTHER FOODS, allow the oven to preheat before placing food in the oven.

1. On double ovens only, press UPPER OVEN or, on some models, LOWER OVEN.  
The cavity symbol will flash indicating which oven was chosen. The left cavity symbol is the upper oven, the right cavity symbol is the lower oven.
2. Press BAKED GOODS, MEATS or OTHER FOODS.
3. Press number pads to enter standard cook temperature.
4. Press number pads to enter standard cook time.

5. Press START.  
“CHECK FOOD AT” and the stop time will appear on the oven display.  
When the stop time is reached, end-of-cycle tones will sound if enabled. Open the door and check food.
6. Press CANCEL OFF, UPPER OVEN CANCEL / OFF or, on some models, LOWER OVEN CANCEL / OFF if food is done to taste.  
or
7. Close door to continue cooking.

### To Delay Start:

## ⚠ WARNING

### Food Poisoning Hazard

**Do not let food sit in oven more than one hour before or after cooking.**

**Doing so can result in food poisoning or sickness.**

Before setting delay start, make sure the clock is set to the correct time of day. See “Clock” section. Delay start should not be used for food such as breads and cakes because they may not bake properly.

1. On double ovens only, press UPPER OVEN or, on some models, LOWER OVEN.  
The cavity symbol will flash indicating which oven was chosen. The left cavity symbol is the upper oven, the right cavity symbol is the lower oven.
2. Press BAKED GOODS, MEATS or OTHER FOODS.
3. Press number pads to enter standard cook temperature.
4. Press number pads to enter standard cook time.
5. Press STOP TIME.
6. Press the number pads to enter time of day to stop.
7. Press START.

The start time is automatically calculated and displayed. “DELAY” and the stop time will also appear on the oven display.

When the start time is reached, the oven will automatically turn on. The vertical bar countdown and minute time countdown will appear on the oven display.

When the stop time is reached, the oven will shut off automatically and “End” will appear on the oven display.

If enabled, end-of-cycle tones will sound, then reminder tones will sound every minute.

8. Press CANCEL OFF, UPPER OVEN CANCEL / OFF or, on some models, LOWER OVEN CANCEL / OFF or open the oven door to clear the display and/or stop reminder tones.



## Dehydrating

(single, upper and, on some models, lower oven)

Dehydrating dries food. For additional information, refer to a book written specifically about dehydrating or preserving foods. Dehydration racks and an oven door stop are required, but not supplied with this oven. See "Assistance or Service" section to order.

### To Dehydrate:

Before dehydrating, prepare food as recommended in the recipe and arrange on dehydration rack(s). Position racks according to the following chart. See "Positioning Racks and Bakeware" section for diagram of rack positions.

NUMBER OF RACKS	RACK POSITION(S)
1	3
2	2 and 4
3	1, 3 and 5

Place the oven door stop over the automatic oven light switch.

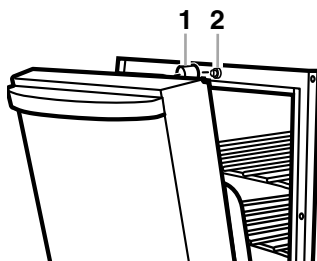

1. Oven door stop  
2. Automatic oven light switch

1. On double ovens only, press UPPER OVEN or, on some models, LOWER OVEN.  
The cavity symbol will flash indicating which oven was chosen. The left cavity symbol is the upper oven, the right cavity symbol is the lower oven.
2. Press and hold CONVECTION BAKE for 5 seconds.  
Press the number pads to enter a temperature other than 140°F (60°C). The dehydrating range can be set between 100°F and 200°F (38°C and 95°C).
3. Press START.
4. Press CANCEL OFF, UPPER OVEN CANCEL / OFF or, on some models, LOWER OVEN CANCEL / OFF when finished dehydrating.

## Proofing Bread

(single, upper and, on some models, lower oven)

Proofing bread prepares dough for baking by activating the yeast. Proofing twice is recommended.

### To Proof:

Before first proofing, place dough in a lightly greased bowl and cover loosely with wax paper coated with shortening. Place on rack guide two, then place broiler pan on guide one. See "Positioning Racks and Bakeware" for diagram. Put 2 cups (500 mL) of boiling water in broiler pan. Close door.

1. On double ovens only, press UPPER OVEN or, on some models, LOWER OVEN.

The cavity symbol will flash indicating which oven was chosen. The left cavity symbol is the upper oven, the right cavity symbol is the lower oven.

2. Press and hold BAKED GOODS for 5 seconds.  
Display will show 100°F (40°C).

3. Press START.

Let dough rise until nearly doubled in size, check at 20-25 minutes. Proofing time may vary depending on dough type and quantity.

Before second proofing, shape dough, place in baking pan(s) and cover loosely with plastic wrap coated with cooking spray. Follow same placement, broiler pan and water and control steps above. Before baking, remove plastic wrap.

## Temperature Probe

(single and upper ovens only)

### WARNING



#### Burn Hazard

**Use an oven mitt to remove temperature probe.**

**Do not touch broil element.**

**Failure to follow these instructions can result in burns.**

The temperature probe accurately measures the internal temperature of meat, poultry and casseroles with liquid and should be used in determining the doneness of meat and poultry. It should not be used during maxi and econo broiling, convection broiling, dehydrating or proofing bread.

Always unplug and remove the temperature probe from the oven when removing food.

### To Use:

Before using, insert the probe into the center of the thickest portion of meat or into the inner thigh or breast of poultry, away from fat or bone. Place food in oven and connect the temperature probe to the jack. Keep probe as far away from heat source as possible. Close oven door.

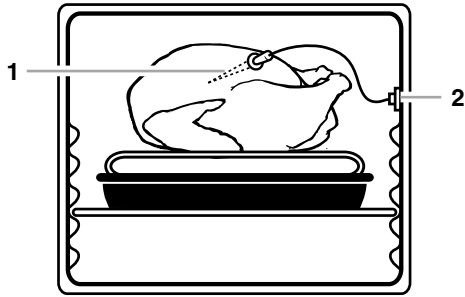

1. Temperature probe  
2. Temperature probe jack

1. On double ovens only, press UPPER OVEN.
2. Press the number pads to enter a probe temperature (internal temperature of food when done), if other than the default temperature of 160°F (71°C). The probe temperature may be set anywhere from 130°F to 190°F (54°C to 88°C).
3. Press BAKE, CONVECTION BAKE or CONVECTION ROAST. Press number pads to enter the oven temperature (from recipe), if other than the one displayed.
4. Press START.  
The set oven temperature will appear on the oven display throughout cooking.  
“Lo” will appear as the probe temperature until the internal temperature of the food reaches 130°F (54°C). Then the display will show the temperature increasing in 5°F (3°C) increments.  
When the set probe temperature is reached, the oven will shut off automatically and “End” will appear on the oven display.  
If enabled, end-of-cycle tones will sound, then reminder tones will sound every minute.
5. Press CANCEL OFF or UPPER OVEN CANCEL / OFF or open the oven door to clear the display and/or stop reminder tones.

### To Change Probe Temperature, Oven Setting:

1. Unplug probe, plug back in, then close oven door.
2. Follow steps 1 through 5 under the “To Use” section.

### To Use Upper Oven with Probe and Lower Oven at the Same Time:

1. Follow steps 1 through 4 under the “To Use” section.
2. Press LOWER OVEN. The probe’s temperature setting will disappear from the display.
3. Press BAKE or BROIL.  
Press the number pads to enter a temperature other than the one displayed.
4. Press UPPER OVEN. The probe’s temperature setting will reappear on the display.  
For the probe to work properly when using the lower oven, make sure to press the UPPER OVEN key to bring back the probe’s temperature setting on the display each time a change has been made to the lower oven operation.
5. Press START.
6. Press CANCEL OFF or open the oven door to clear the display and/or stop reminder tones.

## Timed Cooking

### **! WARNING**

#### **Food Poisoning Hazard**

**Do not let food sit in oven more than one hour before or after cooking.**

**Doing so can result in food poisoning or sickness.**

Timed Cooking allows the oven(s) to be set to turn on at a certain time of day, cook for a set length of time, and/or shut off automatically. Delay start should not be used for food such as breads and cakes because they may not bake properly.

#### **To Set a Cook Time:**

1. On double ovens only, press UPPER OVEN or LOWER OVEN.

The cavity symbol will flash indicating which oven was chosen. The left cavity symbol is the upper oven, the right cavity symbol is the lower oven.

2. Press BAKE, CONVECTION BAKE or CONVECTION ROAST.

Press the number pads to enter a temperature other than the one displayed.

3. Press COOK TIME.

4. Press number pads to enter the length of time to cook.

5. Press START.

The start time, stop time, vertical bar countdown and minute time countdown will appear on the oven display.

On double oven models only, when both upper and lower ovens are being used at the same time, touch UPPER OVEN or LOWER OVEN to display the respective cook time.

When the stop time is reached, the oven will shut off automatically and “End” will appear on the oven display.

If enabled, end-of-cycle tones will sound, then reminder tones will sound every minute.

6. Press CANCEL OFF, UPPER OVEN CANCEL / OFF or LOWER OVEN CANCEL / OFF or open the oven door to clear the display and/or stop reminder tones.

#### **To Set a Cook Time and Stop Time:**

Before setting, make sure the clock is set to the correct time of day. See “Clock” section.

1. On double ovens only, press UPPER OVEN or LOWER OVEN.

The cavity symbol will flash indicating which oven was chosen. The left cavity symbol is the upper oven, the right cavity symbol is the lower oven.

2. Press BAKE, CONVECTION BAKE or CONVECTION ROAST.

Press the number pads to enter a temperature other than the one displayed.

3. Press COOK TIME.

4. Press number pads to enter the length of time to cook.

5. Press STOP TIME.

6. Press the number pads to enter time of day to stop.

7. Press START.

The start time is automatically calculated and displayed.

“DELAY” and the stop time will also appear on the oven display.

When the start time is reached, the oven will automatically turn on. The vertical bar countdown and minute time countdown will appear on the oven display.

When the stop time is reached, the oven will shut off automatically and “End” will appear on the oven display.

If enabled, end-of-cycle tones will sound, then reminder tones will sound every minute.

8. Press CANCEL OFF, UPPER OVEN CANCEL / OFF or LOWER OVEN CANCEL / OFF or open the oven door to clear the display and/or stop reminder tones.

# OVEN CARE

## Self-Cleaning Cycle (on some models)

### **⚠ WARNING**



#### **Burn Hazard**

**Do not touch the oven during the Self-Cleaning cycle.**

**Keep children away from oven during Self-Cleaning cycle.**

**Failure to follow these instructions can result in burns.**

**IMPORTANT:** The health of some birds is extremely sensitive to the fumes given off during the Self-Cleaning cycle. Exposure to the fumes may result in death to certain birds. Always move birds to another closed and well ventilated room.

Self-clean the oven before it becomes heavily soiled. Heavy soil results in longer cleaning and more smoke.

Keep the kitchen well-ventilated during the Self-Cleaning cycle to help get rid of heat, odors, and smoke.

Do not block the oven vent(s) during the Self-Cleaning cycle. Air must be able to move freely. See "Oven Vent(s)" section.

Do not clean, rub, damage or move the oven door gasket. The door gasket is essential for a good seal.

#### **Prepare Oven:**

- Remove the broiler pan, grid, cookware and bakeware and, on some models, the temperature probe from the oven.
- Remove any foil from the oven because it may burn or melt, damaging the oven.
- Remove oven racks to keep them shiny and easy to slide. See "General Cleaning" section for more information.
- Hand clean inside door edge and the 1½ in. (3.8 cm) area around the inside oven cavity frame, being careful not to move or bend the gasket. This area does not get hot enough during self-cleaning to remove soil. Do not let water, cleaner, etc. enter slots on door frame. Use a damp cloth to clean this area.
- Wipe out any loose soil to reduce smoke and avoid damage. At high temperatures, foods react with porcelain. Staining, etching, pitting or faint white spots can result. This will not affect cooking performance.

#### **How the Cycle Works**

**IMPORTANT:** The heating and cooling of porcelain on steel in the oven may result in discoloring, loss of gloss, hairline cracks and popping sounds.

The Self-Cleaning cycle uses very high temperatures, burning soil to a powdery ash.

The oven is preset for a 3 hour 30 minute clean cycle, however the time can be changed. Suggested clean times are 2 hours 30 minutes for light soil and between 3 hours 30 minutes to 4 hours 30 minutes for average to heavy soil.

Once the oven has completely cooled, remove ash with a damp cloth. Do not wipe down any of the inside surfaces until the oven has completely cooled down. Applying a cool damp cloth to the inner door glass before it has cooled completely could result in the glass breaking.

The oven lights will not work during the Self-Cleaning cycle.

On double oven models, only one oven can self-clean at a time. If one oven is self-cleaning, the other oven can not be set or turned on.

#### **To Self-Clean:**

Before self-cleaning, make sure the door is closed completely or it will not lock and the cycle will not begin.

1. On double ovens only, press UPPER OVEN or LOWER OVEN.

The cavity symbol will flash indicating which oven was chosen. The left cavity symbol is the upper oven, the right cavity symbol is the lower oven.

2. Press CLEAN.

Press the number pads to set a clean time other than 3 hours 30 minutes. The clean time can be set between 2 hours 30 minutes and 4 hours 30 minutes.

3. Press START.

The oven door will automatically lock and "DOOR LOCKED," the start time and stop time will appear on the oven display. The door will not unlock until the oven cools.

When the cycle is complete and the oven is cool, "End" will appear on the oven display and "DOOR LOCKED" will disappear.

4. Press any pad or open the oven door to clear the oven display.

#### **To Delay Start Self-Clean:**

Before delay starting Self-Clean, make sure the clock is set to the correct time of day. See "Clock" section. Also, make sure the door is closed completely or it will not lock and the cycle will not begin.

1. On double ovens only, press UPPER OVEN or LOWER OVEN.

The cavity symbol will flash indicating which oven was chosen. The left cavity symbol is the upper oven, the right cavity symbol is the lower oven.

2. Press CLEAN.

Press the number pads to set a clean time other than 3 hours 30 minutes. The clean time can be set between 2 hours 30 minutes and 4 hours 30 minutes.

3. Press STOP TIME.

4. Press the number pads to enter the time of day to stop.

5. Press START.

The start time is automatically calculated and displayed.

The door will automatically lock and “DOOR LOCKED,” “DELAY,” and the stop time will also appear on the display. The door will not unlock until the oven cools.

When the start time is reached, the oven will automatically turn on.

When the cycle is complete and the oven cools, “End” will appear on the oven display and “DOOR LOCKED” will disappear.

6. Press any pad or open the oven door to clear the oven display.

**To Stop Self-Clean any time:**

Press CANCEL OFF, UPPER OVEN CANCEL / OFF or LOWER OVEN CANCEL / OFF. If the oven temperature is too high, the door will remain locked. It will not unlock until the oven cools.

## General Cleaning

**IMPORTANT:** Before cleaning, make sure all controls are off and the oven is cool. Always follow label instructions on cleaning products.

Soap, water and a soft cloth or sponge are suggested first unless otherwise noted.

### STAINLESS STEEL (on ARCHITECT™ Series models only)

Do not use soap-filled scouring pads, abrasive cleaners, Cooktop Polishing Creme, steel-wool pads, gritty washcloths or some paper towels. Damage may occur.

Rub in direction of grain to avoid damaging.

- Stainless Steel Cleaner & Polish (not included):  
See “Assistance or Service” section to order.
- Liquid detergent or all-purpose cleaner:  
Rinse with clean water and dry with soft, lint-free cloth.
- Vinegar for hard water spots

### OVEN DOOR EXTERIOR

- Glass cleaner and paper towels or non-abrasive plastic scrubbing pad:  
Apply glass cleaner to soft cloth or sponge, not directly on panel.

### CONTROL PANEL

Do not use abrasive cleaners, steel-wool pads, gritty washcloths or some paper towels. Damage may occur.

- Glass cleaner and soft cloth or sponge:  
Apply glass cleaner to soft cloth or sponge, not directly on panel.

### OVEN CAVITY

Do not use oven cleaners.

Food spills should be cleaned when oven cools. At high temperatures, foods react with porcelain and staining, etching, pitting or faint white spots can result.

- Self-Cleaning cycle:  
See “Self-Cleaning Cycle” first.

## OVEN AND ROASTING RACKS

- Self-Cleaning cycle:  
See “Self-Cleaning Cycle” first. Remove racks or they will discolor and become harder to slide. If this happens, a light coating of vegetable oil applied to the rack guides will help them slide.
- Steel wool pad

## BROILER PAN AND GRID

Do not clean in the Self-Cleaning cycle.

- Mildly abrasive cleanser:  
Scrub with wet scouring pad.
- Solution of ½ cup (125 mL) ammonia to 1 gal. (3.75 L) water:  
Soak for 20 minutes, then scrub with scouring or steel wool pad.
- Oven cleaner:  
Follow product label instructions.  
Porcelain enamel only, not chrome
- Dishwasher

## TEMPERATURE PROBE (on some models)

- Plastic scouring pad

## Oven Lights

The oven lights are 12-volt, 5-watt maximum halogen bulbs. They will come on when the oven door is opened. On double oven models, both upper and lower lights will come on when either door is opened. The oven lights will not work during the Self-Cleaning cycle. When the oven door is closed, press OVEN LIGHT to turn them on or off.

**To Replace:**

Before replacing, make sure the oven is off and cool.

1. Disconnect power.
2. Remove glass light cover by grasping the front edge and pulling away from oven.



3. Remove bulb from socket.
4. Replace bulb, replace bulb cover by snapping back into wall.
5. Reconnect power.

---

## Oven Door

For normal range use, it is not suggested to remove the oven door. However, if necessary, follow these instructions. The oven door is heavy.

### To Remove:

1. Open oven door all the way.
2. Flip up the hinge latch on each side.

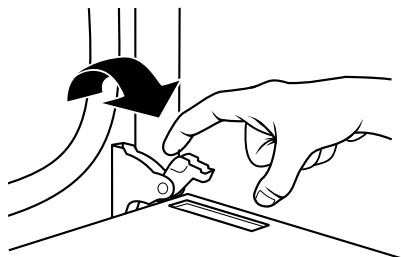

3. Close the oven door as far as it will shut.
4. While holding the oven door on each side with both hands, lift the oven door up.

Continue to push the oven door closed and pull it away from the oven door frame.

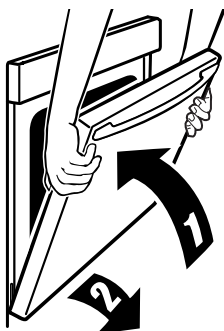

### To Replace:

1. Insert both hanger arms into the door.



2. Open the oven door.  
You should hear a “click” as the door is set into place.
3. Move the hinge levers back to the locked position. Ensure that the door is free to open and close. If not, repeat the removal and installation procedures.

---

# TROUBLESHOOTING

Try the solutions suggested here first in order to avoid the cost of an unnecessary service call.

---

## Nothing will operate

- **Has a household fuse been blown or has the circuit breaker been tripped?**  
Replace the fuse or reset the circuit.
- **Is the appliance wired properly?**  
See Installation Instructions.

---

## Oven will not operate

- **Is the electronic oven control set correctly?**  
See “Electronic Oven Control” section.
- **Has a delay start been set?**  
See “Timed Cooking” section.
- **On some models, is the Control Lock set?**  
See “Control Lock” section.
- **On some models, is the Sabbath Mode set?**  
See “Sabbath Mode” section.
- **On double oven models, is one oven self-cleaning?**  
When one oven is self-cleaning the other oven cannot be set or turned on.
- **On double oven models, has the correct oven been selected?**  
Choose UPPER OVEN or LOWER OVEN first.

---

## Oven temperature too high or too low

- **Does the oven temperature calibration need adjustment?**  
See “Oven Temperature Control” section.

---

## Display shows messages

- **Is the display showing “PF”, “PF id=27” or “PF id=30”?**  
There has been a power failure. Clear the display. See “Display(s)” section. On some models, reset the clock, if needed. See “Clock” section.
- **Is the display showing a letter followed by a number?**  
Clear the display. See “Display(s)” section. If it reappears, call for service. See “Assistance or Service” section.

---

## Self-Cleaning cycle will not operate

- **Is the oven door open?**  
Close the oven door all the way.
- **Has the function been entered?**  
See “Self-Cleaning Cycle” section.
- **On some models, has a delay start Self-Clean cycle been set?**  
See “Self-Cleaning Cycle” section.
- **Has a delay start been set?**  
See “Timed Cooking” section.
- **On double oven models, is one oven self-cleaning?**  
When one oven is self-cleaning, the other oven cannot be set to self-clean.

---

## Oven cooking results not what expected

---

- **Is the appliance level?**  
Level the appliance. See the Installation Instructions.
- **Is the proper temperature set?**  
Double-check the recipe in a reliable cookbook.
- **Is the proper oven temperature calibration set?**  
See "Oven Temperature Control" section.
- **Was the oven preheated?**  
See "Baking and Roasting" section.
- **Is the proper bakeware being used?**  
See "Bakeware" section.
- **Are the racks positioned properly?**  
See "Positioning Racks and Bakeware" section.
- **Is there proper air circulation around bakeware?**  
See "Positioning Racks and Bakeware" section.
- **Is the batter evenly distributed in the pan?**  
Check to make sure batter is level in the pan.
- **Is the proper length of time being used?**  
Adjust cooking time.
- **Has the oven door been opened while cooking?**  
Oven peeking releases oven heat and can result in longer cooking times.
- **Are baked items too brown on the bottom?**  
Move rack to higher position in the oven.
- **Are pie crust edges browning early?**  
Use aluminum foil to cover the edge of the crust.

---

# ASSISTANCE OR SERVICE

Before calling for assistance or service, please check "Troubleshooting." It may save you the cost of a service call. If you still need help, follow the instructions below.

When calling, please know the purchase date and the complete model and serial number of your appliance. This information will help us to better respond to your request.

### If you need replacement parts

If you need to order replacement parts, we recommend that you only use factory specified parts. These factory specified parts will fit right and work right because they are made with the same precision used to build every new KITCHENAID® appliance.

To locate factory specified parts in your area, call our Customer Interaction Center telephone number or your nearest KitchenAid designated service center.

---

## In the U.S.A.

Call the KitchenAid Customer Interaction Center toll free:

**1-800-422-1230.**

### Our consultants provide assistance with:

- Features and specifications on our full line of appliances.
- Installation information.
- Accessory and repair parts sales.
- Specialized customer assistance (Spanish speaking, hearing impaired, limited vision, etc.).
- Referrals to local dealers, repair parts distributors, and service companies. KitchenAid designated service technicians are trained to fulfill the product warranty and provide after-warranty service, anywhere in the United States.

To locate the KitchenAid designated service company in your area, you can also look in your telephone directory Yellow Pages.

### For further assistance

If you need further assistance, you can write to KitchenAid with any questions or concerns at:

KitchenAid Brand Home Appliances  
Customer Interaction Center  
553 Benson Road  
Benton Harbor, MI 49022-2692

Please include a daytime phone number in your correspondence.

### Accessories U.S.A.

To order accessories, call the KitchenAid Customer Interaction Center toll free at **1-800-442-9991** and follow the menu prompts. Or visit our website at [www.kitchenaid.com](http://www.kitchenaid.com) and click on "Shop-Online," then "Accessories."

### Stainless Steel Cleaner & Polish

(stainless steel models)  
Order Part #4396095

### Dehydration Kit

(includes 3 racks and an oven door stop)  
Order Part #4395974A96

---

## In Canada

For product related questions, please call the KitchenAid Canada Customer Interaction Center toll free: **1-800-461-5681**

Monday to Friday 8:00 a.m. - 6:00 p.m. (EST).

Saturday 8:30 a.m. - 4:30 p.m. (EST).

### Our consultants provide assistance with:

- Features and specifications on our full line of appliances.
- Referrals to local dealers.

### For parts, accessories and service in Canada

Call **1-800-807-6777**. KitchenAid designated service technicians are trained to fulfill the product warranty and provide after-warranty service, anywhere in Canada.

### For further assistance

If you need further assistance, you can write to KitchenAid Canada with any questions or concerns at:

Customer Interaction Center  
KitchenAid Canada  
1901 Minnesota Court  
Mississauga, Ontario L5N 3A7

Please include a daytime phone number in your correspondence.

---

# KITCHENAID® COOKTOP, BUILT-IN OVEN AND RANGE WARRANTY

---

## ONE-YEAR FULL WARRANTY

For one year from the date of purchase, when this appliance is operated and maintained according to instructions attached to or furnished with the product, KitchenAid will pay for factory specified parts and repair labor costs to correct defects in materials or workmanship. Service must be provided by a KitchenAid designated service company.

---

## SECOND THROUGH FIFTH YEAR LIMITED WARRANTY ON ELECTRIC ELEMENTS, CERAMIC GLASS COOKTOP, GAS BURNERS, AND SOLID STATE TOUCH CONTROL SYSTEM

On electric ranges and electric cooktops, in the second through fifth years from the date of purchase, when this appliance is operated and maintained according to instructions attached to or furnished with the product, KitchenAid will pay for factory specified parts for any electric element to correct defects in materials or workmanship.

On ceramic glass ranges and ceramic glass cooktops, in the second through fifth years from the date of purchase, when this appliance is operated and maintained according to instructions attached to or furnished with the product, KitchenAid will pay for factory specified parts for the ceramic glass cooktop. KitchenAid warrants that the ceramic glass cooktop will not discolor, the cooktop pattern will not wear off, the rubber seal between the ceramic glass cooktop and porcelain edge will not crack, the ceramic glass cooktop will not crack due to thermal shock and the surface unit elements will not burn out.

On gas ranges and gas cooktops, in the second through fifth years from the date of purchase, when this appliance is operated and maintained according to instructions attached to or furnished with the product, KitchenAid will pay for factory specified parts for any gas burner to correct defects in materials or workmanship.

On ranges and built-in ovens, in the second through fifth years from the date of purchase, when this appliance is operated and maintained according to instructions attached to or furnished with the product, KitchenAid will pay for factory specified parts for the porcelain oven cavity/inner door if the part rusts through due to defects in materials or workmanship. KitchenAid will pay for factory specified parts for solid state touch control system and Magnetron tube in combination ovens to correct defects in materials or workmanship.

---

## SIXTH THROUGH TENTH YEAR LIMITED WARRANTY ON PRO LINE™ RANGES AND BUILT-IN OVENS PORCELAIN OVEN CAVITY/INNER DOOR

On PRO LINE™ ranges and built-in ovens only, in the sixth through tenth years from date of purchase, when this appliance is operated and maintained according to instructions attached to or furnished with the product, KitchenAid will pay for factory specified parts for the oven cavity/inner door if the part rusts through due to defects in materials or workmanship.

---

### KitchenAid will not pay for:

1. Service calls to correct the installation of your appliance, to instruct you how to use your appliance, to replace house fuses or correct house wiring, or to replace owner-accessible light bulbs.
  2. Repairs when your appliance is used in other than normal, single-family household use.
  3. Pickup and delivery. Your appliance is designed to be repaired in the home.
  4. Damage resulting from accident, alteration, misuse, abuse, fire, flood, improper installation, acts of God or use of products not approved by KitchenAid or KitchenAid Canada.
  5. Repairs to parts or systems resulting from unauthorized modifications made to the appliance.
  6. Replacement parts or repair labor costs for units operated outside the United States or Canada.
  7. In Canada, travel or transportation expenses for customers who reside in remote areas.
  8. Any labor costs during the limited warranty periods.
- 

### KITCHENAID AND KITCHENAID CANADA SHALL NOT BE LIABLE FOR INCIDENTAL OR CONSEQUENTIAL DAMAGES.

Some states or provinces do not allow the exclusion or limitation of incidental or consequential damages, so this exclusion or limitation may not apply to you. This warranty gives you specific legal rights, and you may also have other rights which vary from state to state or province to province.

**Outside the 50 United States and Canada, this warranty does not apply. Contact your authorized KitchenAid dealer to determine if another warranty applies.**

If you need service, first see the "Troubleshooting" section of this book. After checking "Troubleshooting," additional help can be found by checking the "Assistance or Service" section or by calling the KitchenAid Customer Interaction Center, **1-800-422-1230** (toll-free), from anywhere in the U.S.A. In Canada, contact your KitchenAid designated service company or call **1-800-807-6777**. 4/01

---

**Keep this book and your sales slip together for future reference. You must provide proof of purchase or installation date for in-warranty service.**

Write down the following information about your appliance to better help you obtain assistance or service if you ever need it. You will need to know your complete model number and serial number. You can find this information on the model and serial number label/plate, located on your appliance as shown in the "Parts and Features" section.

Dealer name \_\_\_\_\_

Address \_\_\_\_\_

Phone number \_\_\_\_\_

Model number \_\_\_\_\_

Serial number \_\_\_\_\_

Purchase date \_\_\_\_\_