

*Installation
instructions
for your new*



**ELECTRIC RANGE
with
Microwave Upper Oven**



INSTALLATION INSTRUCTIONS

Before you begin, read the following instructions completely and carefully. If followed, they will simplify the installation job.

IMPORTANT: OBSERVE ALL GOVERNING CODES AND ORDINANCES

SAVE THESE INSTRUCTIONS FOR THE LOCAL ELECTRICAL INSPECTOR'S USE

WARNING

A. THIS MICROWAVE OVEN IS DESIGNED FOR USE IN THE HOUSEHOLD ONLY AND MUST NOT BE USED FOR COMMERCIAL PURPOSES.

B. Remove all packing material from the oven cavity. When unpacking the unit, check for damage such as misaligned door, damaged gaskets around the door, or dents inside the oven or on the exterior. If there is any damage, please do not operate the unit until it has been checked by an authorized Whirlpool service technician and any repairs made, if necessary.

C. Do not remove the outer case, door, or control panel at any time. The unit is equipped with high voltage and should not be handled unless by an authorized Whirlpool trained service technician.

STEP 1

ELECTRICAL REQUIREMENTS

A. A three-wire or four-wire single phase 120/240 volt 60 Hz AC only electrical supply (or three-wire or four-wire 120/208 volt if specified on nameplate) is required on a separate 50 ampere circuit, fused on both sides of the line (time-delay fuse or circuit breaker is recommended). Do NOT fuse neutral.

B. THE RANGE MUST BE CONNECTED WITH COPPER WIRE ONLY. Aluminum wire must not be used to avoid potentially unsatisfactory connections.

C. Local codes may permit the use of a flexible type 50 ampere UL listed power supply cord (pigtail) with no smaller than No. 8 copper wire to match three-wire receptacle of NEMA type 10-50R shown in Figure 1. A suitable strain relief must be provided at the point the copper power supply cord enters the appliance.

D. The appliance may be connected directly to the fused disconnect (or circuit breaker) box through flexible armored or non-metallic sheathed copper cable. Allow three feet (minimum) of slack in the line between the wall and the appliance so that it can be moved if servicing is ever necessary. A suitable strain relief must be provided at each end of the copper power supply cord (at the appliance and at the junction box). Wire sizes (COPPER WIRE ONLY) and connections must conform with the rating of the appliance (50 Amp.). Do not use an extension cord.

E. CAUTION: For mobile home installations the appliance wiring must be revised. The appliance frame must not be connected to the neutral terminal, but must be connected to the ground wire (green) of the four-wire copper power supply cord.

If a four-wire receptacle of NEMA type 14-50R is used (see Figure 1), a matching UL listed copper power supply cord (pigtail) must be used. This cord should contain two No. 8, one No. 10 white neutral and one No. 8 green ground (minimum) copper conductors with ring terminals on the range end and the other end terminating in a NEMA type 14-50P

plug. The cord should be type SRD or SRDT, with a strain relief, and be at least 4 feet long. The copper power supply cord and strain relief are not provided with the range.

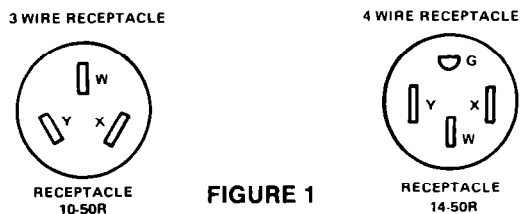

FIGURE 1

Typical 50 ampere receptacles for use where local codes permit use of flexible power supply cord (pigtail).

STEP 2 GENERAL

The back of a Free Standing Range may be installed against a vertical wall. The sides may be installed against base cabinets or against vertical walls extending above the upper edge of the cook top.

To prevent possible discoloration of the base cabinets, the front of the oven frame must extend at least $\frac{1}{2}$ " past the front surface or cabinet doors of the base cabinets.

TO ELIMINATE THE HAZARD OF REACHING OVER HEATED SURFACE ELEMENTS, CABINETS OR STORAGE SPACES SHOULD NOT BE PROVIDED OVER A RANGE.

IF CABINETS ARE PROVIDED, THE HAZARD CAN BE REDUCED BY INSTALLING A RANGE HOOD THAT PROJECTS HORIZONTALLY A MINIMUM OF 5 INCHES BEYOND THE BOTTOM OF THE CABINETS.

When installing the range between base cabinets, refer to **Figure 2** for the size of the opening needed. Do not seal range to cabinets.

If a service cord is used, the wall receptacle should be located in accordance with the dimensions given in **Figure 2**.

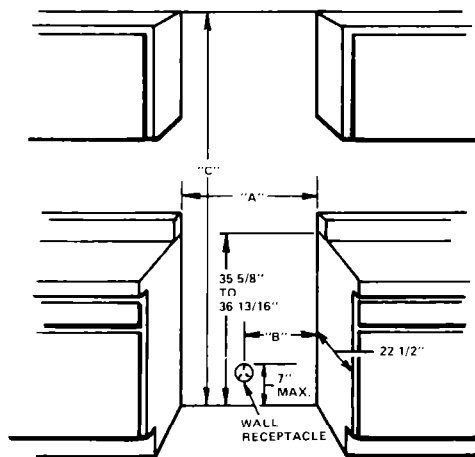

FIGURE 2

"A" 30" RANGES— $30\frac{3}{8}$ " TO $30\frac{1}{2}$ "

"B" 30" RANGES—15" TO 17"

NOTE: COPPER SERVICE CORD OR POWER SUPPLY CORD (PIGTAIL) MUST RUN DOWNWARD, LEFT OR RIGHT TO WALL RECEPTACLE TO AVOID PINCHING CORD BETWEEN REAR PORTION OF RANGE AND WALL.

"C" Eye level ranges without vent hood = $66\frac{1}{8}$ " minimum. Eye level ranges with REH6330 vent hood $71\frac{1}{8}$ " minimum. See page 6 of this instruction for details on installing REH6330 vent hood.

Top of range or vent hood may be against bottom of top cabinet.

STEP 3 REMOVE SHIPPING SKID

Using two of the carton corner posts to protect the finish of the range, lay the range on its back. Remove the four shipping skid bolts. Next back out the four leveling legs about half way. (The leveling legs are shipped installed in the base of the range.) See Figure 3. Discard the skid and shipping bolts.

Stand the range upright.

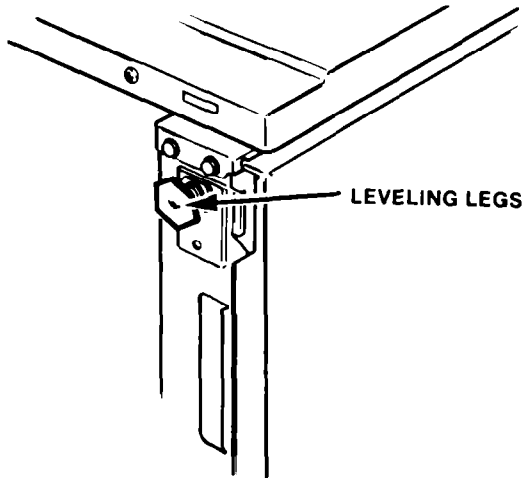

FIGURE 3

STEP 4 ELECTRICAL CONNECTION

It is the personal responsibility of the customer to contact a qualified installer to assure that the electrical installation is adequate and is in conformance with the National Electrical Code and local codes and ordinances.

ELECTRICAL GROUND IS REQUIRED ON THIS APPLIANCE

This appliance is manufactured **with** the neutral terminal connected to the frame.

1. If local codes permit connection of the frame grounding conductor to the neutral wire of the copper power supply cord:

- Remove the terminal block cover (lowest wire cover).
- The terminal nuts are taped to the frame below the terminal block.
NOTE: Do not loosen factory installed nuts.
- Connect the neutral wire of the copper power supply cord to the center silver colored terminal of the terminal block and connect the other wires to the outer terminals. See Figure 4.

Ring type terminals must be used on the copper power supply cord wires.

- Replace terminal block cover.

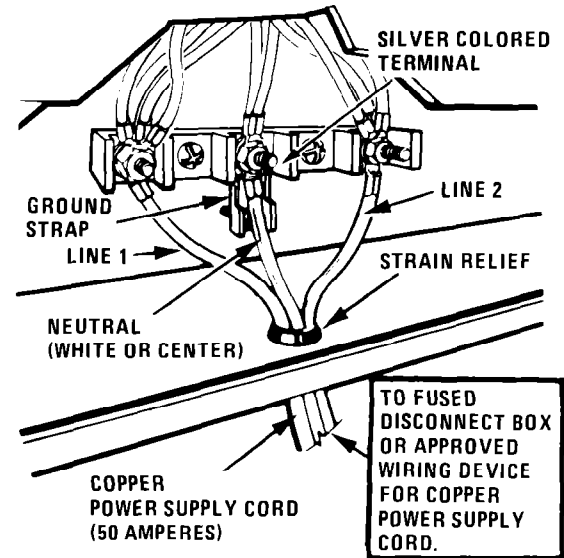

FIGURE 4

2. If local codes DO NOT permit frame grounding to the neutral wire of the copper power supply cord:

- Remove terminal block cover.
- Remove the ground strap from the terminal block and from the appliance frame. Retain the ground screw.
- Connect the neutral wire of the copper power supply cord to the center silver colored terminal of the terminal block and connect the other wires to the outer terminals. See Figure 5. Ring type terminals must be used on the copper power supply cord wires.
- Connect a separate insulated green colored copper ground wire (No. 8 minimum) to a grounded cold water pipe* by means of a clamp, and then to the frame of the appliance with the ground screw, using the hole in the frame where the ground strap was removed. See Figure 5. Do not ground to a gas supply pipe. Do not connect the copper power supply cord to electric power until appliance is permanently grounded. See Figure 6.
- Replace terminal block cover.

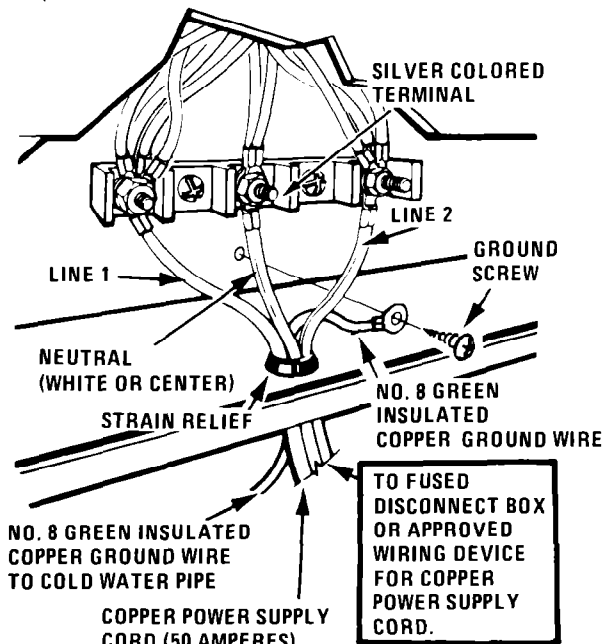

FIGURE 5

*Cold water pipe must have metal continuity to electrical ground and not be interrupted by plastic, rubber or other electrically insulating connectors (including water meter or pump) without adding a jumper wire at these connections.

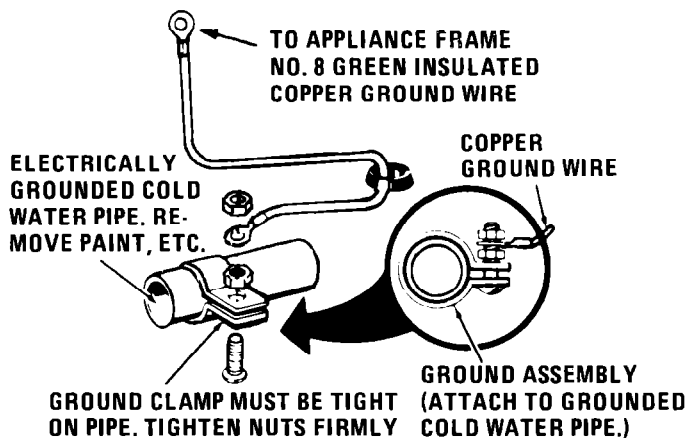

FIGURE 6

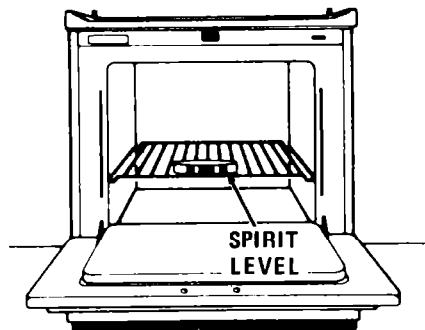

FIGURE 8

2. Next remove the shipping clip from each of the 4 surface units. The clips are for shipping only. To remove the clips:

a. Lift clip with pliers or screwdriver. Bend clip to a vertical position. See Figure 9.

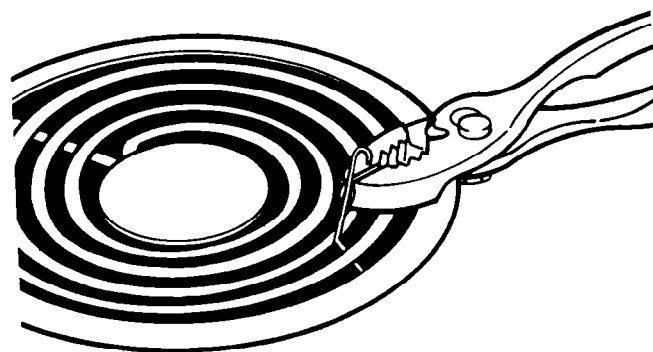

FIGURE 9

3. If connecting to a four-wire electrical system (mobile home):

a. Remove terminal block cover.

b. Remove the ground strap from the terminal block and from the appliance frame. Retain the ground screw.

c. Connect the ground wire (green) of the copper power supply cord to the frame of the appliance with the ground screw, using the hole in the frame where the ground strap was removed. See Figure 7.

d. Connect the neutral (white) wire of the copper power supply cord to the center silver colored terminal of the terminal block and connect the other wires to the outer terminals. Ring type terminals must be used on the copper power supply cord wires.

e. Replace the terminal block cover.

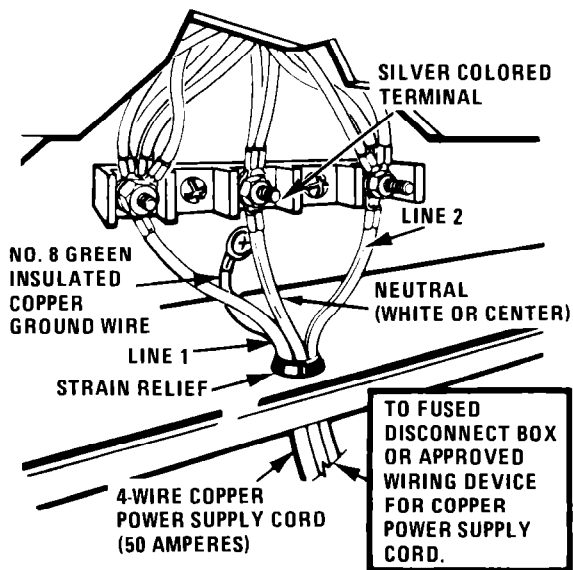

FIGURE 7

b. Remove surface unit and reflector bowl as shown in Use and Care Guide.

c. Remove clip and discard.

d. Replace surface unit and reflector bowl as shown in Use and Care Guide.

3. Make the electrical connection:

a. Plug the flexible copper connector (pigtail) into an approved, receptacle (where local codes permit the use of a pigtail). OR

b. Connect the flexible armored or non-metallic shielded copper cable directly to a fused disconnect box.

STEP 5

LEVEL AND POSITION RANGE

1. Move the range to its final operating position and check the level of the range by using a small spirit level on the oven rack. See Figure 8. The range can be leveled from side to side and front to rear by adjusting the four leveling legs.

PRECAUTIONS TO AVOID POSSIBLE EXPOSURE TO EXCESSIVE MICROWAVE ENERGY

A. Do not attempt to operate this oven with the door open since open-door operation can result in harmful exposure to microwave energy. It is important not to defeat or tamper with the safety interlocks.

B. Do not place any object between the oven front face and the door or allow soil or cleaner residue to accumulate on sealing surfaces.

C. Do not operate the oven if it is damaged. It is particularly important that the oven door close properly and that there is no damage to the:

1. Door (bent)
2. Hinges and latches (broken or loosened)
3. Door seals and sealing surfaces.

D. The oven should not be adjusted or repaired by anyone except properly qualified service personnel.

E. The oven should be checked for microwave leakage by qualified service personnel after a repair is made.

F. Do not operate the oven if the door glass is broken.

CHECK OPERATION

Refer to the Use and Care Guide packaged with the range to check for proper care and cleaning of your range.

SURFACE ELEMENTS

CAUTION: Do not touch the elements. They may be hot and you may get burned.

1. Turn on each of the four (4) surface elements and check to see that they heat. On models so equipped, check the surface element indicator light(s).

NOTE: "COOK 'N COUNTER" MODELS

The front two surface elements will not operate unless the front section of glass is folded back. The rear two surface elements and the oven will not operate unless the glass top is in the complete raised position.

OVEN ELEMENTS

CAUTION: Do not touch the elements. They may be hot and you may get burned.

1. Broil—Turn selector switch to BROIL and set thermostat to high temperature position. The top element should become cherry-red and the indicator light should glow.

2. Bake—Turn selector switch to bake and set thermostat to 350° BAKE temperature. The bottom oven element should become red and the indicator light should glow. The upper oven element should become hot but NOT become red.

ROTISSERIE (If optional kit has been installed)

1. Place straight oven rack on bottom ledge position.
2. Place broiler pan on oven rack.
3. Place special rotisserie rack on broiler pan and position the spit bar on the special rack.
4. Rotation starts upon insertion of spit bar.

CLOCK (If so equipped)

Refer to the operation instructions packaged in the range oven, for operation of the clock.

BEFORE YOU CALL FOR SERVICE...

1. Make sure range copper power cord (pigtail) is plugged in.
2. Check to make sure the house fuse or circuit breaker for your range is not blown or open.

NOTE: The serial plate is located at the bottom center of microwave oven front frame.



In the event your WHIRLPOOL appliance should need service, call the dealer from whom you purchased the appliance or a WHIRLPOOL franchised TECH-CARE® service company. He is in the Yellow Pages of your telephone directory listed under Washers, Dryers—Repairing or Servicing. You can also obtain his name and number by dialing, free, within the continental United States (except Alaska) the Whirlpool COOL-LINE® Service (800) 253-1301 (when calling from Michigan, dial (800) 632 2243; from Alaska or Hawaii, dial (800) 253-1121). Dial just as you normally dial long distance. A special operator will tell you the name and number of your nearest Whirlpool TECH-CARE service outlet. During normal working hours, Whirlpool consultants at this same number will also answer any questions about operating or maintaining your appliance not covered in your Operating Instructions.

Learn the benefits of using TECH-CARE service for maintaining the quality originally built into your WHIRLPOOL appliance.

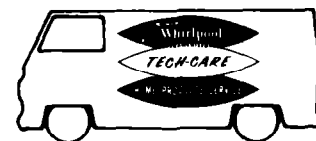

WHIRLPOOL CORPORATION BENTON HARBOR, MICHIGAN 49022

INSTALLATION INSTRUCTIONS

FOR OPTIONAL VENT HOOD KIT (MODEL REH 6330)

INSTALLATION OF VENT HOOD ON THE EYE LEVEL ELECTRIC RANGE

This range may be installed with model REH 6330 Vent Hood Kit.

The overall height of the eye level electric range is 66 $\frac{1}{8}$ ". When installing a Whirlpool vent hood, Model REH6330 (Height 5 $\frac{1}{2}$ ") the overall height needed is 71 $\frac{7}{8}$ " with the leveling legs adjusted out half way.

Note: Before installing the vent hood on the eye level range, make sure Steps 1, 2, 3, 4 and Part 1 of Step 5 are followed for the range installation. Move the eye level electric range so that both the front and back of the range are accessible.

1. Using a hammer and screwdriver, pry out the knockout plug at the right rear of the top panel. See Figure 1.

Note: Make sure not to damage the power supply receptacle located below the knockout plug when removing the plug.

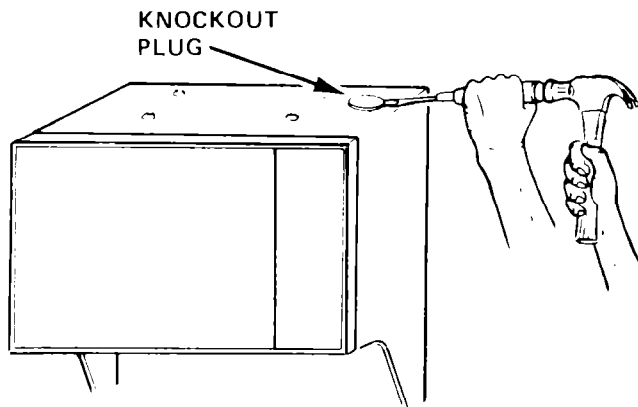

FIGURE 1

2. Take the vent hood and pull the power supply cord through the hole in the bottom of the vent hood until the slack is removed. See Figure 2.

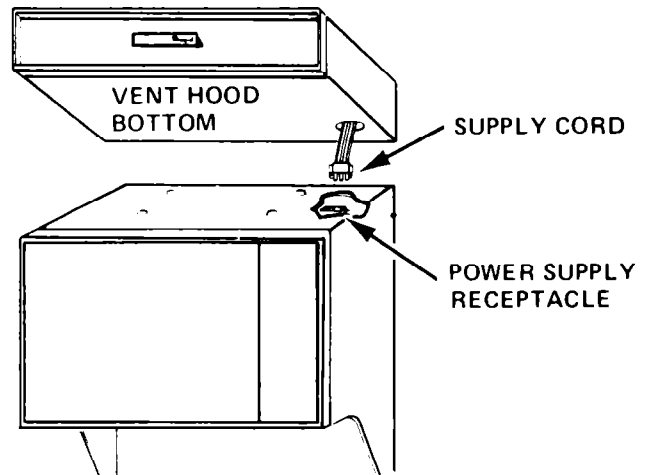

FIGURE 2

3. Set the hood on the oven.

4. Lift the front edge of the vent hood enough to connect the vent hood power supply connector to the receptacle in the top of the oven. See Figure 2.

5. Loosen the screws holding the two small plates on the back of the vent hood. See Figure 3. Rotate the plates until the lower holes line up with the adjacent screw holes in the oven back.

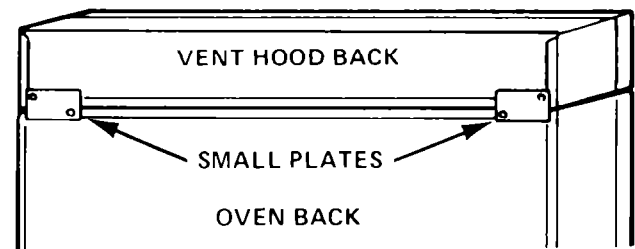

FIGURE 3

6. Position the vent hood mounting plates so that the oven back screw holes can be used to fasten the vent hood to the range.

7. Using the two screws supplied with the vent kit, fasten the plates to the oven back and retighten the screws loosened in Step 5 above.

8. Refer to the installation instructions packed with your vent hood for details on venting the vent hood or how to use the vent hood in a ductless installation.

9. Next, starting with Part 2 of Step 5 in the range instructions, finish installing the range and vent hood assembly.

10. Refer to the operating instructions packed with the vent hood for details on use and care of the vent hood.