

# Owner's Manual and Installation Instructions

# Galaxy™

One-Speed

**AUTOMATIC WASHERS**

**with Water Temperature Control**

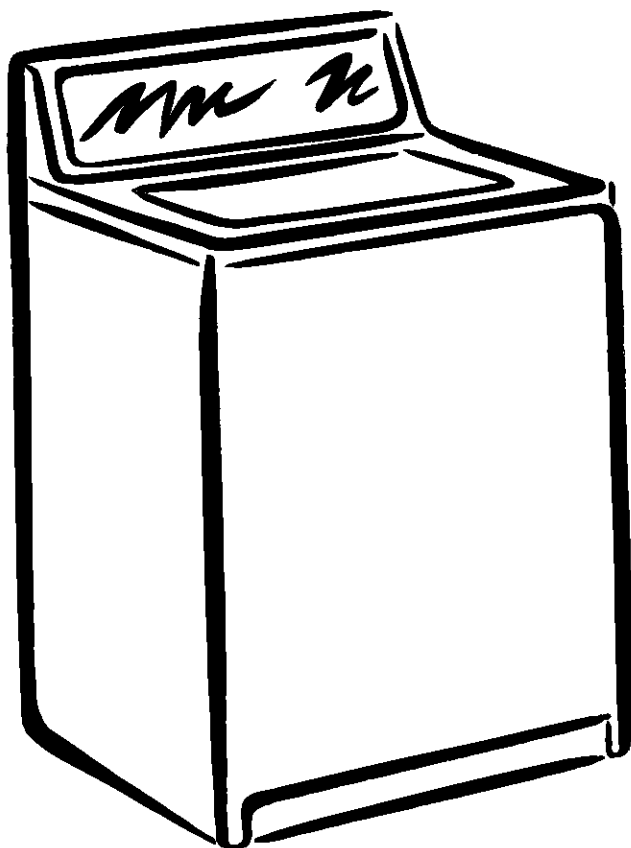

**IMPORTANT:**

Read and follow all safety  
and operating instructions  
before first use of this product.

Sears, Roebuck and Co., Hoffman Estates, IL 60179 U.S.A.  
Sears Canada Inc., Toronto, Ontario, Canada M5B 2B8

[www.sears.com](http://www.sears.com)  
[www.sears.ca](http://www.sears.ca)

# TABLE OF CONTENTS

BEFORE USING .....	2
GALAXY AUTOMATIC WASHER WARRANTY .....	3
WASHER SAFETY .....	4
INSTALLATION REQUIREMENTS .....	6
INSTALLATION INSTRUCTIONS .....	10
WASHER USE .....	14
LAUNDRY TIPS .....	22
WASHER CARE .....	24
TROUBLESHOOTING .....	25
WE SERVICE WHAT WE SELL .....	29

## BEFORE USING

Please read this manual. It will help you install and operate your new Galaxy washer in the most economical way.

For more information about the care and operation of Galaxy appliances, call your nearest Sears store. You will need the complete model and serial numbers when requesting information. Your washer's model and serial numbers are located on the Model and Serial Number Plate.

Use the space below to record the model number and serial number of your new Galaxy washer.

Model No. \_\_\_\_\_

Serial No. \_\_\_\_\_

Date of Purchase \_\_\_\_\_

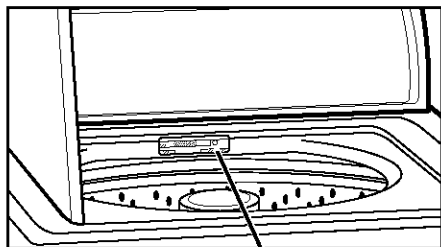

Model and Serial  
Number Plate

Keep this book and your Sears Salescheck (receipt) in a safe place for future reference.

# **GALAXY™ AUTOMATIC WASHER WARRANTY**

## **90-DAY WARRANTY ON MECHANICAL AND ELECTRICAL PARTS**

For ninety days from the date of purchase, when the washer is installed and operated in accordance with the instructions in the Owner's Manual, Sears will repair or replace any mechanical or electrical parts in this washer, if defective in material or workmanship.

## **LIMITED 2-YEAR WARRANTY ON GEARCASE PARTS\***

After ninety days and until two years from the date of purchase, Sears will furnish replacement parts for any defective gearcase parts. You will be charged for labor.

## **LIMITED 5-YEAR WARRANTY ON PLASTIC TUB\***

After ninety days and until five years from date of purchase, Sears will furnish a replacement plastic tub for any plastic tub which is defective in material or workmanship. You will be charged for labor.

If the washer is subjected to other than private family use, the above warranty coverage is effective for only 90 days.

WARRANTY SERVICE IS AVAILABLE BY CONTACTING THE NEAREST SEARS SERVICE CENTER IN THE UNITED STATES OR CANADA.

This warranty applies only while this product is in use in the United States or Canada. This warranty gives you specific legal rights, and you may have other rights which vary from state to state or province to province.

**Sears Roebuck and Co., Dept. 817WA, Hoffman Estates, IL 60179 U.S.A.**

**Sears Canada Inc., Toronto, Ontario M5B 2B8**

\*In Canada, a different warranty may apply. For warranty information, contact Sears Canada Inc. by referencing the service numbers located on the back page of this manual.

ENGLISH

## WASHER SAFETY

### **Your safety and the safety of others are very important.**

We have provided many important safety messages in this manual and on your appliance. Always read and obey all safety messages.



This is the safety alert symbol. This symbol alerts you to potential hazards that can kill or hurt you and others. All safety messages will follow the safety alert symbol and either the word "DANGER" or "WARNING." These words mean:

**! DANGER**

**You can be killed or seriously injured if you don't immediately follow instructions.**

**! WARNING**

**You can be killed or seriously injured if you don't follow Instructions.**

All safety messages will tell you what the potential hazard is, tell you how to reduce the chance of injury, and tell you what can happen if the instructions are not followed.

## IMPORTANT SAFETY INSTRUCTIONS

**WARNING:** To reduce the risk of fire, electric shock, or injury to persons when using your washer, follow basic precautions, including the following:

- Read all instructions before using the washer.
- Do not wash articles that have been previously cleaned in, washed in, soaked in, or spotted with gasoline, dry-cleaning solvents, other flammable or explosive substances as they give off vapors that could ignite or explode.
- Do not add gasoline, dry-cleaning solvents, or other flammable or explosive substances to the wash water. These substances give off vapors that could ignite or explode.
- Under certain conditions, hydrogen gas may be produced in a hot water system that has not been used for 2 weeks or more. **HYDROGEN GAS IS EXPLOSIVE.** If the hot water system has not been used for such a period, before using a washing machine, turn on all hot water faucets and let the water flow from each for several minutes. This will release any accumulated hydrogen gas. As the gas is flammable, do not smoke or use an open flame during this time.
- Do not allow children to play on or in the washer. Close supervision of children is necessary when the washer is used near children.
- Before the washer is removed from service or discarded, remove the door or lid.
- Do not reach into the washer if the drum, tub or agitator is moving.
- Do not install or store this washer where it will be exposed to the weather.
- Do not tamper with controls.
- Do not repair or replace any part of the washer or attempt any servicing unless specifically recommended in the Owner's Manual or in published user-repair instructions that you understand and have the skills to carry out.
- See "Electrical Requirements" for grounding instructions.

**SAVE THESE INSTRUCTIONS**

# INSTALLATION REQUIREMENTS

## Tools and Parts

Assemble the necessary tools and supplies before beginning the washer installation. The parts supplied are in the washer basket.

### Tools needed for connecting the drain hose and water inlet hoses:

- Pliers that open to 1 $\frac{1}{8}$  in. (3.95 cm)
- Flashlight (optional)

### Parts supplied:

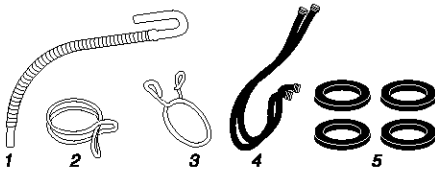

1. Drain hose
2. Silver, double-wire hose clamp (for the bottom of the drain hose)
3. Yellow, single-wire hose clamp (for the top of the drain hose)
4. Water inlet hoses (2)
5. Flat water inlet hose washers (4)

### Tools needed for securing the drain hose and leveling the washer:

- Adjustable or open wrench  $\frac{1}{8}$  in. (14 mm)
- Level
- Wood block
- Ruler or measuring tape

### Parts supplied:

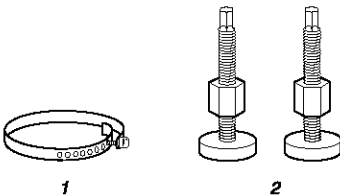

1. Shipping strap with fastener
2. Front leveling feet with nuts (2)

## Alternate Parts

Parts listed are available from your local Sears store or Sears Service Center. Please reference the service numbers located on the back page of this manual.

If you have:	You will need to buy:
Laundry tub or standpipe taller than 96 in. (2.4 m)	Sump pump system (if not already available)
1 in. (2.5 cm) diameter standpipe	2 in. (5 cm) diameter to 1 in. (2.5 cm) diameter standpipe adapter, Part No. 3363920
Overhead sewer	Standard 20 gal. (76 L) 39 in. (99 cm) tall drain tub or utility sink, sump pump and connectors (available from local plumbing suppliers)
Floor drain	Siphon break, Part Number 285320; additional drain hose, Part Number 3357090 and connector kit, Part Number 285442
Water faucets beyond reach of fill hoses	2 longer water fill hoses: 6 ft (1.8 m) Part Number 76314, 10 ft (3.0 m) Part Number 350008
Drain hose too short	Drain hose, Part No. 388423 and hose kit, Part No. 285442
Drain hose that is too long	Hose kit, Part No. 285442
Lint clogged drain	Drain protector, Part No. 367031

## Location Requirements

Selecting the proper location for your washer improves performance and minimizes noise and possible washer "walk."

Your washer can be installed in a basement, laundry room, closet, or recessed area. (See "Drain System.")

Proper installation is your responsibility.

### You will need:

- A water heater set to deliver 120°F (49°C) water to the washer.
- A grounded electrical outlet located within 4 ft (1.2 m) of where the power cord is attached to the back of the washer. (See "Electrical Requirements.")
- Hot and cold water faucets located within 4 ft (1.2 m) of the hot and cold water fill valves, and water pressure of 5-100 psi (34.5-689.6 kPa). Washers with triple dispensers require 20-100 psi (138.0-689.6 kPa) for best performance.
- A level floor with a maximum slope of 1 in. (2.5 cm) under entire washer. Installing the washer on carpeting is not recommended.
- A sturdy floor to support the washer weight (washer, water and load) of 315 lbs (143 kgs).

Do not store or operate your washer in temperatures at or below 32°F (0°C). Some water can remain in the washer and can cause damage in low temperatures. See "Washer Care" for winterizing information.

## Recessed area or closet installation

The dimensions shown are for the recommended spacing allowed, except the closet door ventilation openings. The dimensions shown for the closet door ventilation openings are the minimum required.

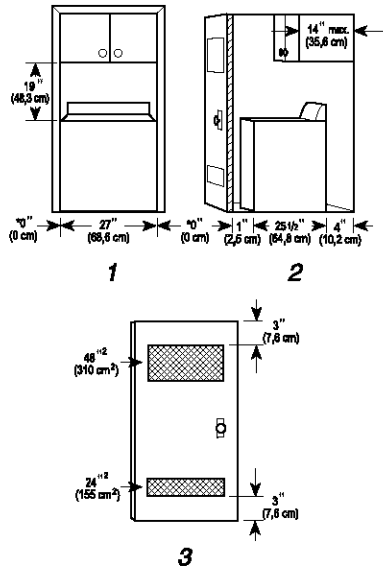

1. Front view  
2. Side view  
3. Closet door with vents

- Additional spacing should be considered for ease of installation and servicing.
- Additional clearances may be required for wall, door and floor moldings.
- Additional spacing of 1 in. (2.5 cm) on all sides of the washer is recommended to reduce noise transfer.
- If a closet door is installed, the minimum air openings in the top and bottom of the door are required. Louvered doors with air openings in the top and bottom are acceptable.
- Companion appliance spacing should also be considered.

## Drain System

The washer can be installed using the standpipe drain system (floor or wall), the laundry tub drain system, or the floor drain system. Select the drain hose installation method you need. (See "Alternate Parts.")

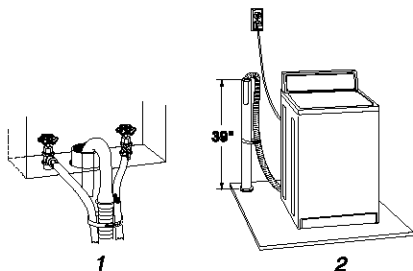

### Standpipe drain system - wall or floor (view 1 & 2)

The standpipe drain requires a minimum diameter standpipe of 2 in. (5 cm). The minimum carry-away capacity can be no less than 17 gal. (64 L) per minute. A 2 in. (5 cm) diameter to 1 in. (2.5 cm) diameter standpipe adapter kit is available. (See "Alternate Parts.")

The top of the standpipe must be at least 39 in. (99 cm) high and no higher than 96 in. (2.4 m) from the bottom of the washer.

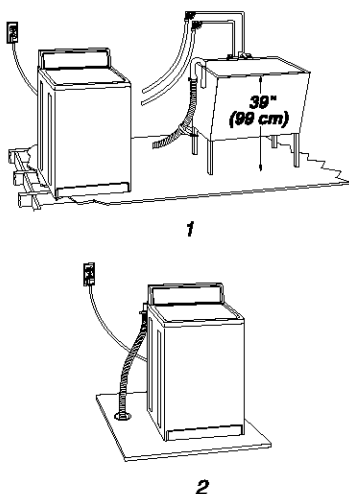

### Laundry tub drain system (view 1)

The laundry tub needs a minimum 20 gal. (76 L) capacity. The top of the laundry tub must be at least 39 in. (99 cm) above the floor and no higher than 96 in. (2.4 m) from the bottom of the washer.

### Floor drain system (view 2)

The floor drain system requires a siphon break that may be purchased separately. (See "Alternate Parts.")

The siphon break must be a minimum of 28 in. (71 cm) from the bottom of the washer. Additional hoses might be needed.

## Electrical Requirements

### ⚠ WARNING



#### Electrical Shock Hazard

- Plug into a grounded 3 prong outlet.
- Do not remove ground prong.
- Do not use an adapter.
- Do not use an extension cord.
- Failure to follow these instructions can result in death, fire, or electrical shock.

- A 120-volt, 60-Hz., AC-only, 15- or 20-ampere, fused electrical supply is required. Time-delay fuse or circuit breaker is recommended. It is recommended that a separate circuit serving only this appliance be provided.
- This washer is equipped with a power supply cord having a 3 prong ground plug.



- To minimize possible shock hazard, the cord must be plugged into a mating, 3 prong, ground-type outlet, grounded in accordance with local codes and ordinances. If a mating outlet is not available, it is the personal responsibility and obligation of the customer to have the properly grounded outlet installed by a qualified electrician.
- If codes permit and a separate ground wire is used, it is recommended that a qualified electrician determine that the ground path is adequate.
- Do not ground to a gas pipe.
- Check with a qualified electrician if you are not sure the washer is properly grounded.
- Do not have a fuse in the neutral or ground circuit.

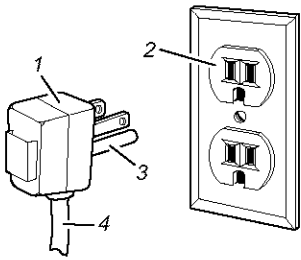

1. 3 prong grounding plug  
 2. 3 prong grounding-type outlet  
 3. Ground prong  
 4. Power supply cord

## GROUNDING INSTRUCTIONS

### For a grounded, cord-connected washer:

This washer must be grounded. In the event of a malfunction or breakdown, grounding will reduce the risk of electrical shock by providing a path of least resistance for electric current. This washer is equipped with a cord having an equipment-grounding conductor and a grounding plug. The plug must be plugged into an appropriate outlet that is properly installed and grounded in accordance with all local codes and ordinances.

**WARNING:** Improper connection of the equipment-grounding conductor can result in a risk of electric shock. Check with a qualified electrician or serviceman if you are in doubt as to whether the appliance is properly grounded.

Do not modify the plug provided with the appliance – if it will not fit the outlet, have a proper outlet installed by a qualified electrician.

### For a permanently connected washer:

This washer must be connected to a grounded metal, permanent wiring system, or an equipment grounding conductor must be run with the circuit conductors and connected to the equipment-grounding terminal or lead on the appliance.

# INSTALLATION INSTRUCTIONS

## Before You Start

### **! WARNING**

#### Excessive Weight Hazard

Use two or more people to move and install washer.

Failure to do so can result in back or other injury.

- To prevent floor damage, set the washer onto cardboard before moving across floor.
- Move the washer to within approximately 3 ft (90 cm) of the final location.

## Remove Shipping Strap

Removing the shipping strap is necessary for smooth operation. If the shipping strap is not removed, the washer will make excessive noise.

1. Do not cut yellow strap. Pull yellow strap firmly, until completely removed from washer. Depending on your model, there will be either two or three cotter pins on the end of the shipping strap when it is pulled out of the washer. The electrical plug is attached to this shipping strap.

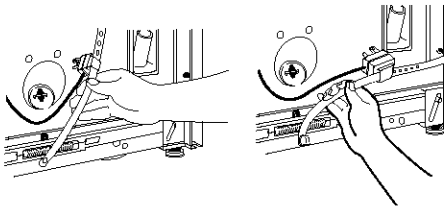

2. Pull firmly to remove the end of the shipping strap that remains pinned to the back of the washer. This will release the rear self-leveling feet.

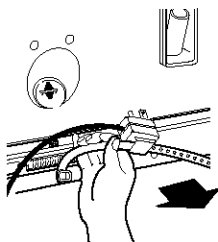

3. Cut the shipping strap about 16 in. (40 cm) from plug end. Look for the words "CUT HERE." Discard end with the cotter pins. Slide remainder of shipping strap from the power cord. You will use the remainder of the shipping strap later to secure the drain hose.

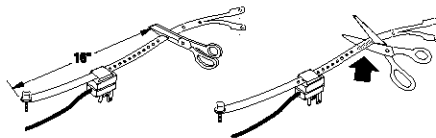

## Connect Drain Hose

Proper connection of the drain hose will protect your floors from damage due to water leakage. To prevent the drain hose from coming off or leaking, it must be installed per the following instructions.

**IMPORTANT:** To ensure proper installation, this procedure must be followed exactly.

1. Check the drain hose to see if it is the proper length.
2. Wet the inside of the straight end of the drain hose with tap water. DO NOT USE ANY OTHER LUBRICANT.
3. Squeeze ears of silver, double-wire clamp with pliers to open. Place clamp over the straight end of the drain hose 1/4 in. (6 mm) from the end.

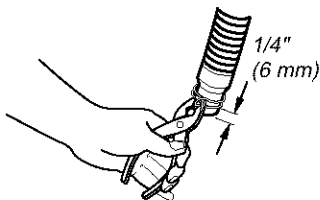

4. Open clamp. Twist hose back and forth while pushing down onto drain connector at the bottom of the washer. Continue until hose contacts the ribbed stop on the cabinet.

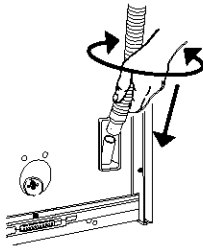

5. Place clamp over area marked "CLAMP." Release clamp.

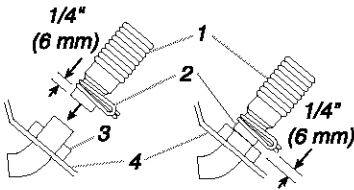

1. Drain Hose
2. Clamp
3. Ribbed Stop
4. Cabinet

### For standpipe or laundry tub drain systems:

1. Open yellow, single-wire clamp with pliers and slide over hooked end of drain hose to secure the rubber and corrugated sections together.

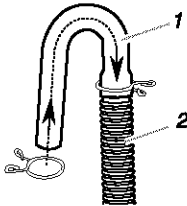

1. Hooked end
2. Drain hose

2. Put hooked end of drain hose into laundry tub or standpipe. Rotate hook to eliminate kinks.

### To prevent drain water from going back into the washer:

- Do not straighten hooked end of drain hose. Do not force excess drain hose into standpipe. Hose should be secure, but loose enough to provide a gap of air.
- Do not lay excess drain hose in bottom of laundry tub.

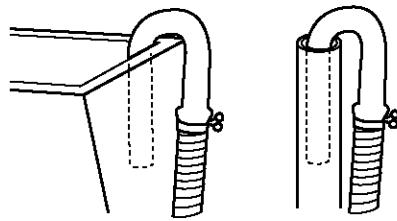

- For floor drain installation, see kit number required under "Alternate Parts."

## Connect Inlet Hoses

1. Insert new flat washers (supplied) into each end of the inlet hoses. Firmly seat the washers in the couplings.

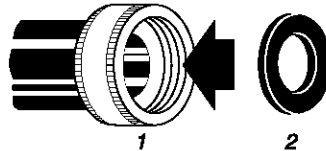

1. Coupling
2. Washer

### Connect the inlet hoses to the water faucets

Make sure the washer basket is empty.

2. Attach the hose with the red coupling to the hot water faucet. Screw on coupling by hand until seated on the washer.
3. Attach the hose with the blue coupling to the cold water faucet. Screw on coupling by hand until seated on the washer.
4. Using pliers, tighten the couplings with an additional two-thirds turn.

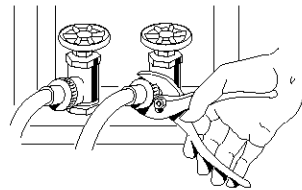

**NOTE:** Do not overtighten. Damage to the valves can result.

## Clear the water lines

5. Run water through both faucets and inlet hoses, into a bucket or laundry tub, to get rid of particles in the water lines that might clog the inlet valve screens.

## Connect the inlet hoses to the washer

6. Attach the hose with the red coupling to the HOT water (bottom) inlet valve. Attaching the red coupling first makes it easier to tighten connection with pliers. Screw on coupling by hand until seated on the washer. Using pliers, tighten the couplings with an additional two-thirds turn.

**NOTE:** Do not overtighten. Damage to the valves can result.

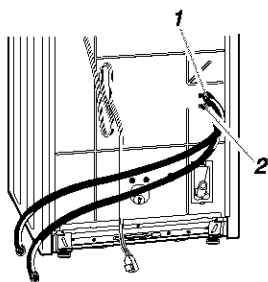

1. Cold water inlet valve (blue)
2. Hot water inlet valve (red)

**NOTE:** The inlet valve may be on the right or the left side of the washer, depending on your model.

7. Attach the hose with the blue coupling to the COLD water (top) inlet valve. Screw on coupling by hand until seated on the washer. Using pliers, tighten the couplings with an additional two-thirds turn.

**NOTE:** Do not overtighten. Damage to the valves can result.

## Check for leaks

8. Turn on the water faucets and check for leaks. A small amount of water might enter the washer. You will drain this later.

**NOTE:** Replace inlet hoses after 5 years of use to reduce the risk of hose failure. Record hose installation or replacement dates for future reference.

- If you only connect one water hose, you must cap off the remaining water inlet port.
- Periodically inspect and replace hoses if bulges, kinks, cuts, wear, or leaks are found.

## Secure Drain Hose

1. Drape the power cord over the console.
2. Remove any cardboard used to move washer.
3. Locate the remaining piece of shipping strap (not the end with the cotter pins) from step 3 of "Remove Shipping Strap." Use it to wrap the drain hose together with the laundry tub or standpipe. Push fastener into the nearest hole in the shipping strap.

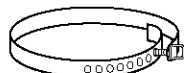

*Remaining portion of Shipping Strap*

4. Wrap the drain hose to the laundry tub leg or standpipe with the tie strap. (See illustration.)

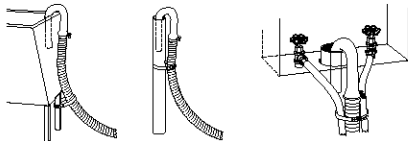

If the washer faucets and the drain standpipe are recessed, put the hooked end of the drain hose in the standpipe. Tightly wrap the tie strap around the water inlet hoses and the drain hose.

## Level Washer

Properly leveling your washer prevents excessive noise and vibration.

### Install the front leveling feet

1. Prop up the front of the washer about 4 in. (10.2 cm) with a wood block or similar object. The block needs to support the weight of the washer.
2. Screw the lock nut onto each foot to within 1 in. (2.5 cm) of the base.

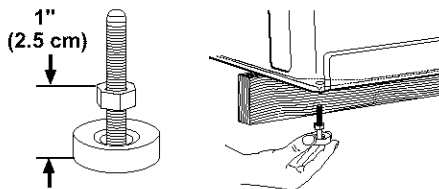

3. Screw the feet into the correct holes at the front corner of the washer until the nuts touch the washer.

**NOTE:** Do not tighten the nuts until the washer is level.

4. Tilt the washer back and remove the wood block. Gently lower the washer to the floor.
5. Slide to final location.
6. Check the levelness of the washer by placing a level on the top edges of the washer; first side-to-side, then front-to-back.

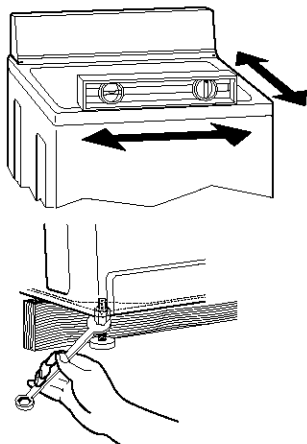

If the washer is not level, move the washer out slightly, tip back, prop up the front of the washer with the wood block and adjust the feet up or down as necessary. Repeat this step until washer is level.

7. After the washer is in the final location and level, use a  $\frac{9}{16}$  in. (1.43 cm) open-end wrench to turn the nuts on the feet tightly against the washer cabinet.

If the nuts are not tight against the washer cabinet, the washer may vibrate.

8. Tilt the washer forward until the rear of the washer is at least 4 in. (10.2 cm) off the floor. You may hear the self-adjusting rear feet click into place. Lower the washer to the floor.

## Complete Installation

1. Check the electrical requirements. Be sure that you have the correct electrical supply and the recommended grounding method. (See "Electrical Requirements.")
2. Check to be sure all parts are now installed. If there is an extra part, go back through the steps to see which step was skipped.

3. Check to be sure you have all of your tools.
4. Check to be sure that the yellow shipping strap was removed from the back of the washer and used to secure the drain hose.
5. Dispose/recycle all packaging materials.
6. Check to be sure the water faucets are on.
7. Check for leaks around faucets and inlet hoses.

## ⚠ WARNING



### Electrical Shock Hazard

**Plug into a grounded 3 prong outlet.**

**Do not remove ground prong.**

**Do not use an adapter.**

**Do not use an extension cord.**

**Failure to follow these instructions can result in death, fire, or electrical shock.**

8. Plug into a grounded 3 prong outlet.
9. Remove the protective film on the console and any tape remaining on the washer.
10. Read "Washer Use."
11. To test your washer, measure half of the normal recommended amount of powdered or liquid detergent and pour it into the washer basket or detergent dispenser (on some models). Close the lid. Select any cycle, and then press START. Allow it to complete one whole cycle.

### *for your* **Benefit**

To get the maximum cleaning and fabric care from your washer, please read and follow these instructions.

**NOTE:** The drawings in this section show the basic features of all models covered by this manual. Refer to the supplied "Feature Sheet" for your washer's particular features.

### **⚠ WARNING**



#### **Fire Hazard**

**Never place items in the washer that are dampened with gasoline or other flammable fluids.**

**No washer can completely remove oil.**

**Do not dry anything that has ever had any type of oil on it (including cooking oils).**

**Doing so can result in death, explosion, or fire.**

**WARNING:** To reduce the risk of fire, electric shock, or injury to persons, read the IMPORTANT SAFETY INSTRUCTIONS before operating this appliance.

## STARTING YOUR WASHER

1. Add measured detergent directly into washer basket. Then place a load of sorted clothes in the washer.
2. Close washer lid.
3. Set WATER LEVEL Control **A** based on the size of your wash load.
4. Set the WATER TEMPERATURE Control **B**.
5. Push the Cycle Selector Control (Timer) Knob **C** in and turn to the right. Set cycle and time according to the type of fabric in the load.

6. Pull the Cycle Selector Control (Timer) Knob **C** out. The dial will rotate as the cycle progresses. The knob will not rotate.

## STOPPING/RESTARTING YOUR WASHER

- To stop the washer at any time, push the Cycle Selector Control (Timer) Knob in **C**.
- Pull the knob out to restart.

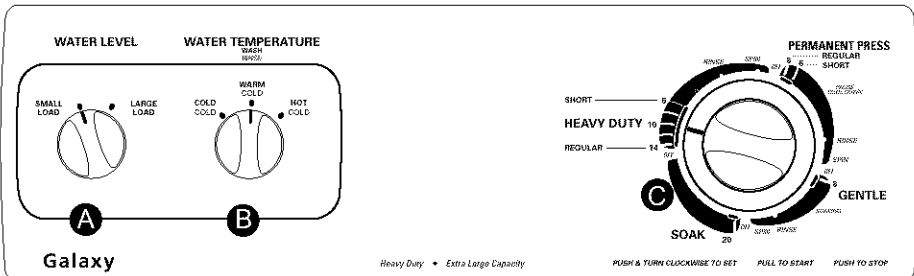

## SET WATER LEVEL CONTROL

### *for your* **Benefit**

This control gives you the flexibility to save water when washing small loads.

Your washer lets you select a water setting based on the size of your wash load. Clothes should move freely and roll toward the agitator.

- For a small load of clothes, select **SMALL LOAD**.
- For a large load of clothes, select **LARGE LOAD**.

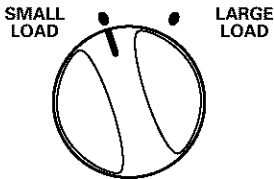

## SET WATER TEMPERATURE CONTROL

Your washer lets you select a wash water setting based on the type of load you are washing.

- All rinses are cold to save energy.

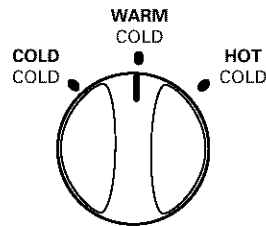

**Selecting Water Temperatures**

Wash Water Temperature	Suggested Fabrics	Comments
HOT 111°F (44°C) or above	<ul style="list-style-type: none"> <li>• Work clothes</li> <li>• Sturdy whites/ colorfast pastels</li> <li>• Diapers</li> </ul>	<ul style="list-style-type: none"> <li>• Best cleaning for heavily soiled items</li> <li>• Removes oils, perspiration, greasy soils and stains</li> <li>• Prevents graying or yellowing</li> </ul>
WARM 90°-110°F (32°-43°C)	<ul style="list-style-type: none"> <li>• Dark/non-colorfast colors</li> <li>• Permanent press items</li> <li>• Nylon, polyester, acrylics, silks, woolens</li> <li>• Knits/delicate fabrics</li> </ul>	<ul style="list-style-type: none"> <li>• Best for moderately soiled to lightly soiled items</li> <li>• Safe for most fabric finishes</li> <li>• Less fading and dye bleeding</li> <li>• Reduces wrinkling</li> </ul>
COLD* 70°-90°F (21°-32°C)	<ul style="list-style-type: none"> <li>• Extra-sensitive colors</li> <li>• Non-colorfast items</li> <li>• Hand washables</li> </ul>	<ul style="list-style-type: none"> <li>• Best for very lightly soiled items</li> <li>• Saves hot water</li> </ul>

\*In wash water temperatures colder than 70°F (21°C), detergents do not dissolve well. Also, soils may be difficult to remove and some fabrics may retain wear wrinkles and have increased pilling – the formation of small lint-like balls on the surface of garments. Pilling is the natural result of wearing and washing of garments.



## SETTING YOUR CYCLE SELECTOR (TIMER) CONTROL

Use this control to choose the agitation time and to start the washer.

- For heavy soil and sturdy fabrics, use the full time.
- For light soil and delicate fabrics, use less time.

### PERMANENT PRESS

#### *for your* **Benefit**

The **PERMANENT PRESS** Cycle includes a load cooling process that reduces wrinkling compared to other cycles.

You can select up to 8 minutes of wash time.

**NOTE:** When the timer reaches PAUSE, the washer will drain and pause for no more than two minutes while some of the wash water is drained and replaced with rinse water.

### HEAVY DUTY

Use this cycle to get up to 14 minutes of wash time for sturdy or heavily soiled loads.

### GENTLE

Use this cycle for cleaning lightly to moderately soiled delicate items and washable knits. The cycle features a periodic agitation and soak.

### SOAK

Use this cycle to help remove heavy soils and stains that need pretreatment.

- Use **WARM** water when soaking. Hot water can set stains.
- Use the amount of detergent or presoak additive recommended by the manufacturer.
- When the **SOAK** cycle ends, add detergent and set a new wash cycle.

**NOTE:** Some "HAND WASH" items, particularly wool, naturally shrink when washed either in the sink or in the washer. Keep this in mind when you purchase items labeled "HAND WASH." Items that shrink should be dried flat. Block these items by gently stretching to original measurements.

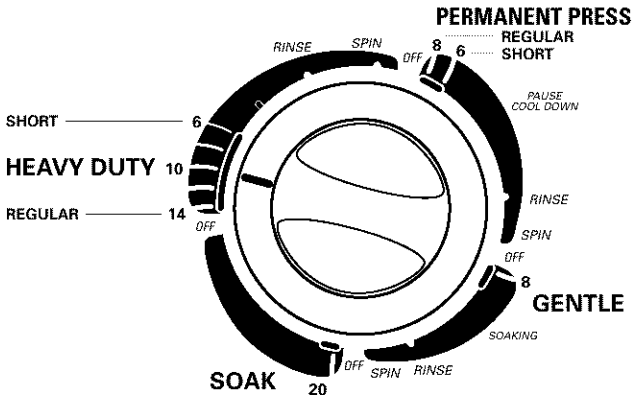

## RINSE AND SPIN

When using extra detergent for heavily soiled clothes, or washing special-care items, you may find an extra rinse and spin is needed.

1. Set **WATER LEVEL** Control.
2. Set **WATER TEMPERATURE** Control.
3. Set the **Cycle Selector Control (Timer) Knob** to a **RINSE** setting.
4. Pull **Cycle Selector Control (Timer) Knob** out to start washer.

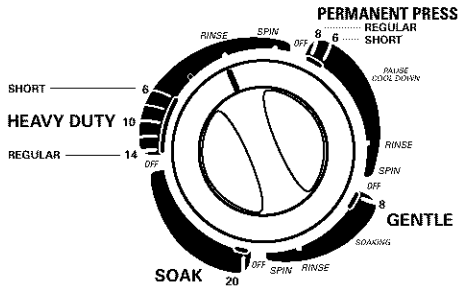

## SPIN ONLY

A drain and spin may help shorten drying times for some heavy fabrics or special-care items by removing excess water.

1. Set the **Cycle Selector Control (Timer) Knob** to a **SPIN** setting.
2. Pull the **Cycle Selector Control (Timer) Knob** out to start washer.

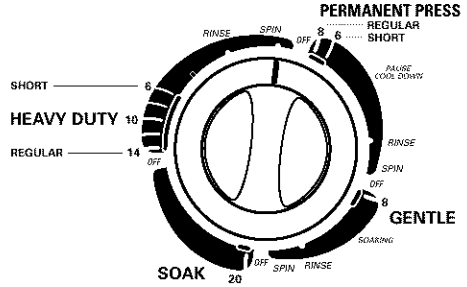

# UNDERSTANDING WHAT HAPPENS IN EACH CYCLE

## PERMANENT PRESS

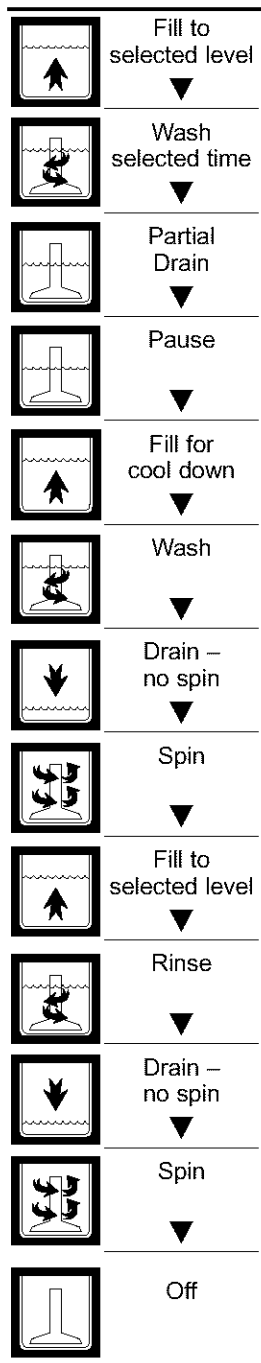

## HEAVY DUTY

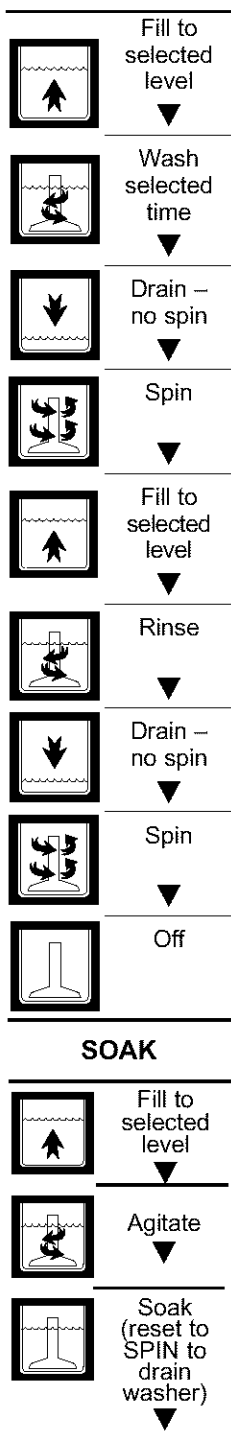

## GENTLE

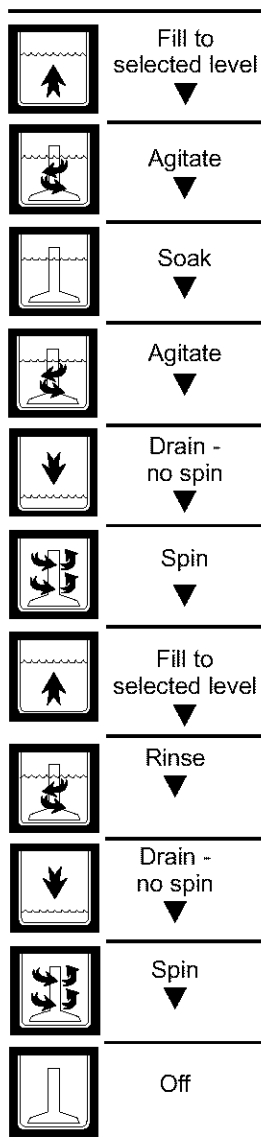

## STRAIGHT VANE AGITATOR

This agitator is found in Galaxy large capacity washers. Its design is well-suited to handle your everyday loads.

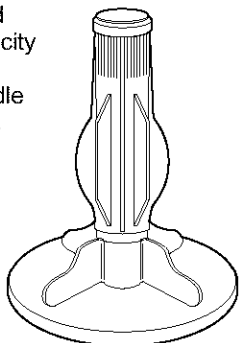

## UNDERSTANDING NORMAL WASHER SOUNDS

Your new washer may make sounds that your old one didn't. Because the sounds are unfamiliar, you may be concerned about them.

The following describes some of the normal sounds you may hear and what causes them.

### During Washing

When you select a small load size setting for a small wash load, your washer has a lower water level. With this lower water level, you may hear a clicking sound from the upper portion of the agitator.

### During Drain

The rate that water is drained from your washer depends on your installation. If water is drained quickly from the washer, you may hear air being pulled through the pump. This happens during the end of draining.

### After Drain and Before Spin

When the cycle changes from draining to spinning, you may hear a noise as the gearcase shifts.

## LAUNDRY TIPS

### PREPARING CLOTHES FOR WASHING

#### *for your* **Benefit**

Follow these recommendations to help you prolong the life of your garments.

- Close zippers, snaps, and hooks to avoid snagging other items. Remove pins, buckles, and other hard objects to avoid scratching the washer interior. Remove non-washable trim and ornaments.
- Empty pockets and turn them inside-out.
- Turn down cuffs; brush away lint and dirt.
- Turn synthetic knits inside-out to avoid pilling.
- Tie strings and sashes so they will not tangle.
- Mend tears, loose hems, and seams.
- Treat spots and stains.
- Stained or wet garments should be washed promptly for best results.

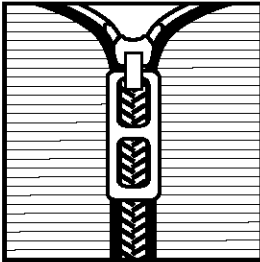

### SORTING

- Separate heavily soiled items from lightly soiled ones, even if they would normally be washed together. Separate lint-givers (towels, chenille) from lint-takers (corduroy, synthetics, permanent press). When possible, turn lint-givers inside-out.
- Separate dark colors from light colors, colorfast items from non-colorfast items.
- Sort by fabric and construction (sturdy cottons, knits, delicate items).

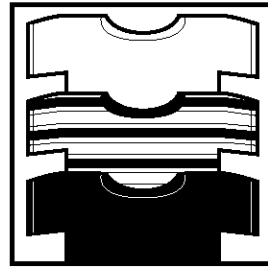

## LOADING

### *for your* **Benefit**

Proper loading of your washer contributes to proper cleaning and fabric care and reduces machine noise.

- Drop items into washer loosely. Fill to the top of the basket (top row of holes). Do not wrap items around the agitator. Items should move easily through wash water for best cleaning and wrinkle-free results. Items should sink and reappear later.
- Load washer properly and select correct water level setting. Overloading or packing the machine, and selecting a setting too small for the wash load can:
  - cause poor cleaning
  - increase wrinkling
  - create excessive lint
  - wear out items faster (because of pilling)
- Load by the amount of space items take up, not by their weight.
- Mix large and small items in each load. Load evenly to maintain washer balance. An off-balance load can make the washer vibrate during spin.
- Use a higher water level setting to reduce wrinkling with permanent press clothes and some synthetic knits. These items should have more room to move in the water than heavy items (towels, jeans).

- Reduce wash time by using a lower water level setting. Loads with only a few small items need less wash time.

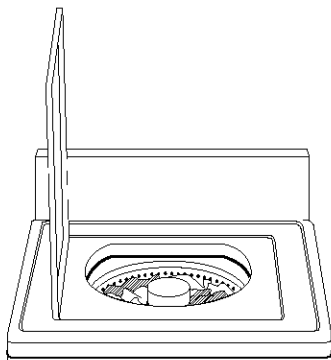

## LOADING SUGGESTIONS

For these suggested full-sized loads, set the WATER LEVEL Selector to the highest water level setting.

EXTRA LARGE CAPACITY		
Heavy Work Clothes	Towels	Mixed Load
3 jeans	7 bath towels	2 sheets (1 king, 1 twin)
3 workpants	8 hand towels	2 pillowcases
2 workshirts	9 wash cloths	2 shirts
1 sweatshirt		2 blouses
1 sweatpants		6 T-shirts
		5 shorts
		6 handkerchiefs

# WASHER CARE

## CLEANING YOUR WASHER

### Exterior

Wipe up detergent, bleach, and other spills with a soft, damp cloth or sponge as they occur. Occasionally wipe the outside of the washer to keep it looking like new.

Do not put sharp or metal objects in your washer. They can damage the finish. Check all pockets for pins, clips, money, bolts, nuts, etc. Do not lay these objects on your washer after emptying pockets.

### Interior

Clean interior with 1 cup (250 mL) of chlorine bleach mixed with 2 cups (500 mL) of detergent. Run washer through a complete cycle using hot water. Repeat process if necessary.

**NOTE:** Remove hard water deposits using only cleaners labeled as washer safe.

## WATER INLET HOSES

Replace inlet hoses after five years of use to reduce the risk of hose failure. Periodically inspect and replace inlet hoses if bulges, kinks, cuts, wear, or leaks are found. When replacing your inlet hoses, mark the date of replacement on the label with a permanent marker.

## WINTER STORAGE OR MOVING CARE

Install and store your washer where it will not freeze. Because some water may stay in the hoses, freezing can damage your washer. If storing or moving your washer during freezing weather, winterize it.

### To winterize washer:

1. Shut off both water faucets.
2. Disconnect and drain water inlet hoses.
3. Put 1 qt (1 L) of R.V.-type antifreeze in the basket.
4. Run washer on a SPIN setting for about 30 seconds to mix the antifreeze and water. Some of the mixture will pump out while the washer spins.
5. Unplug washer or disconnect power.

### To use washer again:

1. Flush water pipes and hoses.
2. Reconnect water inlet hoses.
3. Turn on both water faucets.
4. Plug in washer or reconnect power.
5. Run the washer through a complete cycle with 1 cup (250 mL) of detergent to clean out antifreeze.

## NON-USE OR VACATION CARE

Operate your washer only when you are at home. If you will be on vacation or not using your washer for an extended period of time, you should:

- Unplug washer or disconnect power.
- Turn off the water supply to the washer. This helps avoid accidental flooding (due to a water pressure surge) while you are away.

## TROUBLESHOOTING

**Most laundering problems are easily solved if you understand the cause. Check these lists for common laundry and washer problems. If you need further assistance, see the back cover.**

<b>Problem</b>	<b>Possible Cause</b>	<b>Solution</b>
<b>Washer Leaks</b>	Household plumbing is leaking.	Repair plumbing.
	Inlet hoses not tight.	Tighten hoses (see "Installation Instructions").
	Inlet hose washers not properly seated.	Reseat washers (see "Installation Instructions").
	Drain hose not properly clamped or is off.	Clamp drain hose (see "Installation Instructions").
	Drain is clogged.	Remove drain clogs. Sink, standpipe, or floor drain must be able to handle 17 gal. (64 L) of water per minute.
	Tub moved forward during unloading, causing water to deflect off tub ring.	Ensure tub is centered before starting washer.
	Unit not level causing water to deflect off tub ring.	Ensure front feet are installed and nuts are tightened. Level washer. Reset rear legs (see "Installation Instructions").
	Load is unbalanced. Spray rinses are deflecting off load.	Redistribute the load.
	Washer is overloaded. Fills or spray rinses are deflecting off load.	Reduce load size.
<b>Won't Drain/ Won't Spin/ Wet Loads</b>	Drain hose is kinked or clogged.	Straighten or unplug hose (see "Installation Instructions").
	Correct operation of neutral drain.	After a wash or rinse, the washer will drain without spinning. After draining, the spinning begins.
	Lid is open.	Close the lid.
	Drain hose is more than 96 in (2.4 m) above floor.	Lower drain hose (see "Installation Requirements").
	Too much detergent – excessive sudsing.	Use less detergent.
	Wrong cycle for load being washed.	Choose a cycle with a higher spin speed (see "Washer Use").



<b>Problem</b>	<b>Possible Cause</b>	<b>Solution</b>
<b>Won't Drain/ Won't Spin/ Wet Loads (cont.)</b>	Low voltage or using an extension cord.	Check electrical source or call electrician. Do not use extension cords.
	Cold rinses.	Cold rinses leave loads wetter than warm rinses. This is normal.
<b>Continues to Fill/ Continues to Drain/ Cycle Stuck</b>	Drain hose is less than 39 in. (99 cm) above floor.	Raise the drain hose (see "Installation Requirements").
	Drain hose fits tightly into standpipe.	Adjust drain hose for loose fit (see "Installation Instructions").
	Drain hose taped into standpipe.	Do not seal off drain hose with tape. The drain hose needs an air gap.
<b>Washer Makes Noise</b>	Load is unbalanced.	Redistribute load.
	Washer is not level. Rear leveling legs not set.	Level washer. Reset rear legs (see "Installation Instructions").
	Nuts on front feet not tight.	Tighten nuts (see "Installation Instructions").
	Yellow shipping strap with cotter pins not completely removed.	Remove strap with cotter pins (see "Installation Instructions").
	Floor not strong enough to support washer.	Relocate washer (see "Installation Requirements").
	Gears engaging after drain and before spin.	This is normal.
	Upper part of agitator clicks during wash.	This is normal.
<b>Won't Fill/Won't Rinse/Won't Agitate/ Wrong Temperature</b>	Water inlet valve screens are plugged.	Clean screens.
	Water is turned off.	Turn on water.
	Hot and cold hoses are reversed.	Reverse hoses (see "Installation Instructions").
	Inlet hose is kinked.	Straighten hoses.
	Timer dial is not lined up.	Turn timer knob to the right slightly and pull to start.
	Power cord not plugged in.	Plug into a grounded 3 prong outlet.

<b>Problem</b>	<b>Possible Cause</b>	<b>Solution</b>
<b>Machine Stops</b>	Power cord not plugged in.	Plug into a grounded 3 prong outlet.
	No power at plug.	Check electrical source or call electrician.
	Fuse blown or circuit breaker open.	Replace fuse or reset circuit breaker. If problem continues, call electrician.
	Using an extension cord.	Do not use extension cords.
	Timer is not lined up.	Turn timer to the right slightly and pull to start.
	Timer knob not pulled out.	Set and pull out knob.
	Machine is overloaded.	Wash smaller loads.
<b>Agitator Not Working</b>	The top of the agitator moves only in one direction.	This is normal.
	The top of the agitator is loose.	This is normal.
<b>Water Level Too Low/Not Completely Filling</b>	The top of the agitator is much higher than the highest water level. This creates a perception of the washer not being full.	This is normal.
<b>Tub is Crooked</b>	Tub pulled forward when unloading.	Ensure tub is centered before starting washer.
	Tub moves.	This is normal.
	Unit not level.	Ensure front feet are installed and nuts are tightened. Level washer. Reset rear legs (see "Installation Instructions").
<b>Lint on Load</b>	Improper sorting.	Sort lint givers from lint takers and by color.
	Overloading.	Lint can be trapped in load if overloaded. Wash smaller loads.
	Paper or tissue in pockets.	Clean out pockets before washing.
	Not enough detergent.	Use enough detergent to hold lint in water.
	Detergent not dissolving. Water temperatures lower than 70°F (21°C).	Use wash water warmer than 70°F (21°C).

<b>Problem</b>	<b>Possible Cause</b>	<b>Solution</b>
<b>Tearing</b>	Overloading. Improper use of washer.	Loads should move freely during wash. Wash smaller loads or increase water level.
	Improper use of chlorine bleach. Undiluted bleach will damage fabrics.	Do not pour chlorine bleach directly on load. Wipe up bleach spills.
	Sharp items not removed from pockets; fasteners not fastened.	Clean out pockets before washing. Zip zippers before washing.
	Items damaged before washing.	Mend rips and broken threads in seams before washing.
<b>Stains on Load</b>	Improper use of fabric softener in washer or dryer.	Dilute fabric softener and add to deep rinse only.
	Iron in water (rust).	Install an iron filter.
	Under use of detergent causing soil to be redeposited.	Use enough detergent to remove soil and hold it in suspension.
	Dye transfer due to not sorting loads properly.	Sort dark clothing from whites and lights.
	Dye transfer due to not unloading washer promptly.	Unload the washer as soon as it stops.
<b>Load is Wrinkled</b>	Not removing load promptly.	Unload the washer as soon as it stops.
	Wrong cycle for fabrics being washed.	Use cold rinses and cycles with slow spin speeds to reduce wrinkling.
	Overloading.	Loads should move freely during wash. Wash smaller loads.
	Hoses reversed.	Reverse hoses (see "Installation Instructions").
<b>Load is Tangled/ Twisted</b>	Overloading.	Loads should move freely during wash. Wash smaller loads.
	Clothes wrapped around agitator.	Do not wrap items around agitator when loading washer.

## WE SERVICE WHAT WE SELL

Your purchase has added value because you can depend on Sears Home Central<sup>®</sup>, for service. With over 12,000 trained repair specialists and access to over 4.2 million parts and accessories, we have the tools, parts, knowledge and skills to ensure our pledge: We Service What We Sell.

### **Sears Maintenance Agreements**

Your Galaxy™ appliance is designed, manufactured and tested to provide years of dependable operation. Yet any major appliance may require service from time to time. The Sears Maintenance Agreement offers you an outstanding service program, affordably priced.

#### **The Sears Maintenance Agreement**

- Is your way to buy tomorrow's service at today's price.
- Eliminates repair bills resulting from normal wear and tear.
- Provides for non-technical and instructional assistance.
- Even if you don't need repairs, provides an annual Preventive Maintenance Check, at your request, to ensure that your appliance is in proper running condition.

**Some limitations apply. For more information, call 1-800-827-6655.**

**For information concerning Sears Canada Maintenance Agreements, call 1-800-361-6665.**

# Get it fixed, at your home or ours!

For repair of major brand appliances **In your own home...**  
no matter who made it, no matter who sold it!

**1-800-4-MY-HOME®** Anytime, day or night  
(1-800-469-4663) (U.S.A. and Canada)

[www.sears.com](http://www.sears.com)

[www.sears.ca](http://www.sears.ca)

---

For repair of carry-in products like vacuums, lawn equipment,  
and electronics, call for the location of your nearest  
**Sears Parts and Repair Center.**

**1-800-488-1222** Anytime, day or night (U.S.A. only)

[www.sears.com](http://www.sears.com)

---

For the replacement parts, accessories and owner's manuals  
that you need to do-it-yourself, call **Sears PartsDirect<sup>SM</sup>!**

**1-800-366-PART** 6 a.m. – 11 p.m. CST, 7 days a week  
(1-800-366-7278) (U.S.A. only)

[www.sears.com/partsdirect](http://www.sears.com/partsdirect)

---

To purchase or inquire about a Sears Service Agreement  
or Sears Maintenance Agreement:

**1-800-827-6655** (U.S.A.)

7 a.m. – 5 p.m. CST, Mon. – Sat.

**1-800-361-6665** (Canada)

9 a.m. – 8 p.m. EST, M – F, 4 p.m. Sat.

---

Para pedir servicio de reparación a  
domicilio, y para ordenar piezas:

**1-888-SU-HOGAR<sup>SM</sup>**  
(1-888-784-6427)

Au Canada pour service en français:

**1-800-LE-FOYER<sup>MC</sup>**  
(1-800-533-6937)  
[www.sears.ca](http://www.sears.ca)

