



GE Profile™ Dishwashers

Safety Instructions 2, 3

Operating Instructions

Care and Cleaning 15, 16

Control Panel and Settings 4-7

Flashing Display Lights 7

Loading Place Settings 14

Loading the Racks 12-14

Optional Accessories 15

Using the Dishwasher 8-11

Troubleshooting Tips 16-18

Consumer Support

Consumer Support 24

Product Registration 19, 20

Warranty 23

Owner's Manual

PDW8900 Series

PDW9700 Series

PDW9900 Series

Write the model and serial numbers here:

Model # _____

Serial # _____

You can find them on the tub wall just inside the door.



IMPORTANT SAFETY INFORMATION. READ ALL INSTRUCTIONS BEFORE USING.

⚠ WARNING!

For your safety, the information in this manual must be followed to minimize the risk of fire or explosion, electric shock, or to prevent property damage, personal injury, or death.



WATER HEATER SAFETY

*Under certain conditions, hydrogen gas may be produced in a water heater that has not been used for two weeks or more. **HYDROGEN GAS IS EXPLOSIVE.***

If the hot water has not been used for two weeks or more, prevent the possibility of damage or injury by turning on all hot water faucets and allow them to run for several minutes. Do this before using any electrical appliance which is connected to the hot water system. This simple procedure will allow any built-up hydrogen gas to escape. Since the gas is flammable, do not smoke or use an open flame or appliance during this process.

Use this appliance only for its intended purpose as described in this Owner's Manual.



PROPER INSTALLATION AND MAINTENANCE

This dishwasher must be properly installed and located in accordance with the Installation Instructions before it is used. If you did not receive an Installation Instructions sheet, you can receive one by visiting www.GEAppliances.com, or by calling 800.GE.CARES (800.432.2737) in the United States. In Canada, visit www.geappliances.ca or call 1.800.361.3400.

- Connect to a grounded metal, permanent wiring system; or run an equipment-grounding conductor with the circuit conductors and connect to the equipment-grounding terminal or lead of the appliance.
 - Improper connection of the equipment-grounding conductor can result in a risk of electric shock. Check with a qualified electrician or service representative if you are in doubt whether the appliance is properly grounded.
 - Use supply conductors rated at least 75°C (167°F).
 - Dispose of discarded appliances and shipping or packing material properly.
 - Do not attempt to repair or replace any part of your dishwasher unless it is specifically recommended in this manual. All other servicing should be referred to a qualified technician.
 - To minimize the possibility of electric shock, disconnect this appliance from the power supply before attempting any maintenance.
- NOTE:** *Turning the dishwasher off does not disconnect the appliance from the power supply. We recommend having a qualified technician service your appliance.*

⚠ WARNING!

DO NOT...



- Do not tamper with controls.
- Do not abuse, sit on or stand on the door or dish rack of the dishwasher.
- Do not discard a dishwasher without first removing the door or removing the door latch.
- Do not store or use combustible materials, gasoline or other flammable vapors and liquids in the vicinity of this or any other appliance.
- Do not allow children to play around the dishwasher when opening or closing the door due to the possibility of small fingers being pinched in the door.
- Do not allow children to play with, on or inside this appliance or any discarded appliance.

▲ **WARNING! RISK OF CHILD ENTRAPMENT**

PROPER DISPOSAL OF THE DISHWASHER

Junked or abandoned dishwashers are dangerous... even if they will sit for "just a few days." If you are getting rid of your old dishwasher, please follow the instructions below to help prevent accidents.

Before You Throw Away Your Old Dishwasher

Take off the door of the washing compartment or remove the door latch (as shown).

NOTE: PDW9700 and PDW9900 Series models also have a latch screw which must be removed (Step 1) as shown.

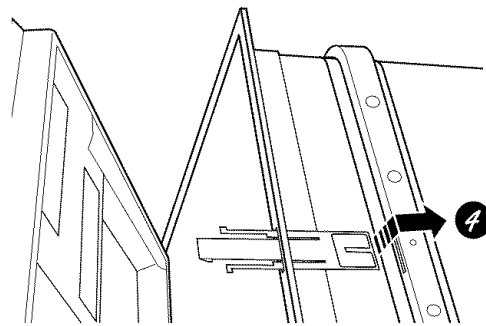
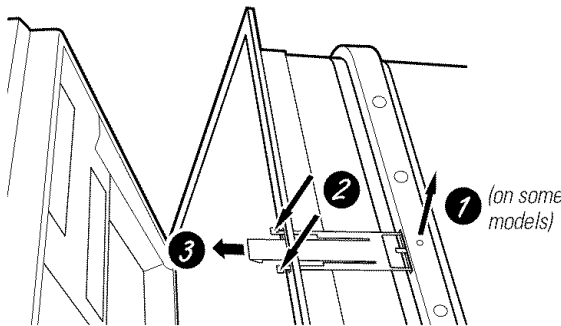

WHEN USING YOUR DISHWASHER

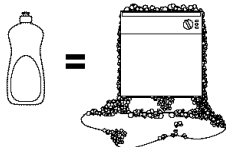
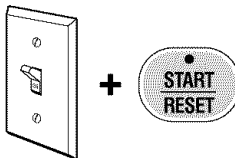
- **CAUTION:** Contents washed in Anti-Bacteria cycle may be hot to the touch. Use care before unloading.
- Use only powder, tabs, liquid detergents or rinse agents recommended for use in a dishwasher and keep them out of the reach of children. **Cascade®** and **Electrasol®** Automatic Dishwashing Detergents and **Jet-Dry®** and **Cascade Rinse Aid®** rinse agents have been approved for use in all GE dishwashers.
- Use only liquid dishwasher detergent when using the Smart Dispenser.
- Using a detergent that is not specifically designed for dishwashers will cause the dishwasher to fill with suds. 
- If your dishwasher is connected to a wall switch, insure that the switch is on prior to use. 
- If you choose to turn the switch off between wash cycles, allow 5–10 seconds after turning the switch on before touching the **START/RESET** pad to allow the control to boot.

- Locate sharp items so that they are not likely to damage the door seal.
- Load sharp knives with the handles up to reduce the risk of cut-type injuries.
- Do not wash plastic items unless marked *dishwasher safe* or the equivalent. For plastic items not so marked, check the manufacturer's recommendations.
- Non-Dishware Items: Do not wash items such as electronic air cleaner filters, furnace filters and paint brushes in your dishwasher. Damage to dishwasher and discoloration or staining of dishwasher may result.
- Do not touch the heating element during or immediately after use.
- Do not operate your dishwasher unless all enclosure panels are properly in place.
- Close supervision is necessary if this appliance is used by or near children.
- Load light, plastic items so they will not become dislodged and drop to the bottom of the dishwasher—they might come into contact with the heating element and be damaged.



READ AND FOLLOW THIS SAFETY INFORMATION CAREFULLY.
SAVE THESE INSTRUCTIONS

About the dishwasher control panel.

You can locate your model number on the tub wall just inside the door. Throughout this manual, features and appearance may vary from your model.

PDW8900 Series

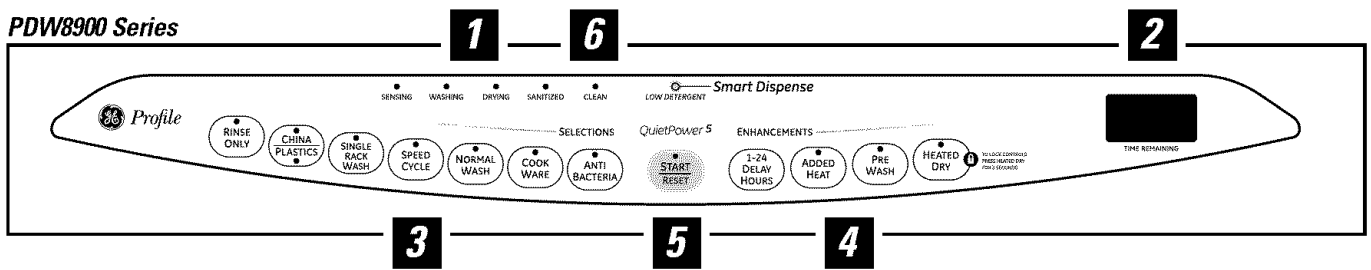

PDW9700 Series and PDW9900 Series

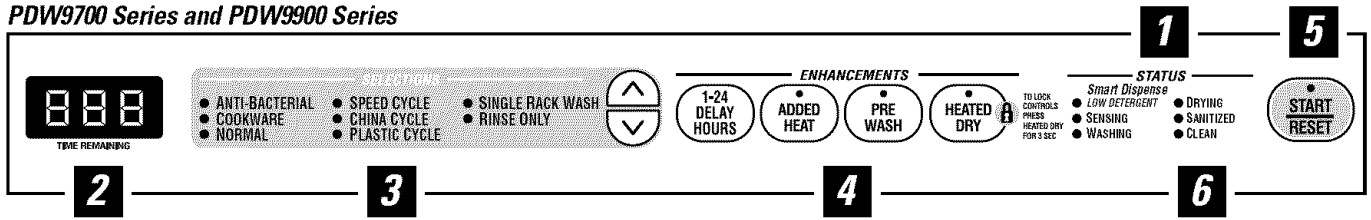

Control Settings

1 Status Indicator Lights (Indicators vary by models)

The Status display tells you what is happening while the dishwasher is in operation and may flash, indicating a malfunction. The lights will come **ON** indicating the sequence of the dishwasher operation.

LOW DETERGENT Displayed when the Smart Dispenser needs to be refilled with liquid dishwasher detergent.

SENSING Displayed while the Clean Sensor™ Sensor is measuring the amount of soil and temperature of water. The dishwasher will adjust the selected cycle to achieve optimal performance.

ADD-A-DISH Displayed during prewash indicating that dishes added now will still be cleaned.

WASHING Displayed during prewash, main wash and rinse periods.

DRYING Displayed during **HEATED DRY**.

SANITIZED Displayed when cycle has met sanitization conditions.

CLEAN Displayed when a wash cycle is complete and enhancements are complete.

2 Time Remaining Display (on some models)

During operation, the display shows the minutes remaining until the cycle is complete. The display may adjust the remaining time while the Sensing light is on. The time displayed at the start of each cycle may change from the factory setting as the unit customizes itself to home use. During a delay start, the display will show hours of time remaining until the cycle starts.

3 Selections

PDW8900 Series: Press the pad for the desired wash cycle.

PDW9700 and PDW9900 Series: Use the Arrow Pads (▲▼) to scroll through the wash cycles.

The light above or next to the selected pad will be **ON** to indicate which **WASH CYCLE** has been selected.

ANTI-BACTERIA Heavy 8.5 gal., 84 min.
(on some models) Medium 7.3 gal., 78 min.
Light 6.1 gal., 75 min.

This cycle raises the water temperature in the final rinse to sanitize your dishware. The cycle length will vary depending on the temperature of your inlet water.

NOTE: The Anti-Bacteria cycle is monitored for sanitization requirements. If the cycle is interrupted during or after the main wash portion or if the incoming water temperature is so low that adequate water heating cannot be achieved, the sanitizing conditions may not be met. In these cases, the sanitized light will not illuminate at the end of the cycle.

NOTE: NSF-certified residential dishwashers are not intended for licensed food establishments.

3 Selections (continued)

COOKWARE (POTS & PANS) **Heavy** 10.9 gal., 94 min.
Medium 8.5 gal., 78 min.
Light 7.3 gal., 73 min.

This cycle is meant for heavily soiled dishes or cookware with dried-on or baked-on soils. This cycle may not remove burned-on foods. Everyday dishes are safe to be used in this cycle.

NORMAL WASH **Heavy** 8.5 gal., 65 min.
Medium 7.3 gal., 60 min.
Light 4.9 gal., 49 min.

This cycle is for medium/heavily soiled dishes and glassware.

SPEED CYCLE 7.3 gal., 35 min.
 (on some models) This cycle is for everyday dishes and glassware.

CHINA CRYSTAL 7.3 gal., 48 min.
 This cycle is for lightly soiled china and crystal.

GLASSES 7.3 gal., 48 min.
 (on some models) This cycle is specifically designed for glasses.

PLASTICS CYCLE **Heavy** 7.3 gal., 58 min.
 (on some models) **Medium** 6.1 gal., 56 min.
Light 4.9 gal., 53 min.

This cycle is specifically designed to reduce the risk of melting plastic items and improve plastic drying. For removing red tomato-based stains, GE recommends the use of Cascade Plastic Booster™.

SINGLE RACK WASH **Heavy** 6.1 gal., 67 min.
 (on some models) **Medium** 5.1 gal., 59 min.
Light 4.1 gal., 44 min.

This cycle washes lightly soiled dishes on the upper rack only.

RINSE ONLY 2.5 gal., 12 min.

For rinsing partial loads that will be washed later. Do not use detergent with this cycle.

NOTE: On the PDW8900 Series models, the **GLASSES/PLASTICS** selector is a toggle pad; toggle the pad until the desired cycle is indicated.

NOTE: This dishwasher is equipped with a CleanSensor™ Sensor with automatic temperature control; therefore, cycle length and time may vary depending on soil and temperature conditions.

NOTE: Only the Anti-Bacteria cycle has been designed to meet the requirements of Section 6, NSF 184 for soil removal and sanitization efficacy.

4 Enhancements

The light above the selected pad will be **ON** to indicate which **ENHANCEMENT** has been selected.

DELAY HOURS You can delay the start of a wash cycle for up to 24 hours (depending on model). Press the **DELAY START** pad to choose the number of hours you want to delay the start of the cycle; then press **START/RESET**.

PDW8900 Series: After closing the door, the machine will count down and start automatically at the correct time.

PDW9700 and PDW9900 Series: After closing the door, the machine will count down and automatically start at the correct time.

NOTE: To cancel the **DELAY START** selection before the cycle begins, press the **DELAY START** pad until the display shows the estimated cycle time for the selected cycle in minutes.

About the dishwasher control panel.

4 Enhancements (continued)

ADDED HEAT (EXTRA HOT WASH) When selected, the cycle will run longer with heating elements on to improve both wash and dry performance.

NOTE: Cannot be selected with **RINSE ONLY** cycle.

PRE WASH (on some models) For use with heavily soiled and/or dried-on, baked-on soils. This option **MUST** be selected **PRIOR** to starting the cycle. This option adds 16 minutes to the cycle time.

NOTE: Cannot be selected with **RINSE ONLY** cycle.

HEATED DRY Light Off Shuts off the drying heat option. Dishes will air dry naturally (PDW8900 Series) or fan dry (PDW9700 and PDW9900 Series) to save energy.

HEATED DRY Light On **PDW8900 Series:** Turns the heater on for fast drying. This will extend the total cycle time by 8 minutes for the **SPEED CYCLE** and 30 minutes for all other cycles.

PDW9700 and PDW9900 Series: Turns the heater on for fast drying. This will extend the total cycle time by 30 minutes for the **ANTI-BACTERIAL** cycle, 38 minutes for the **NORMAL** cycle and **COOKWARE** cycle, 8 minutes for the **SPEED** cycle, 15 minutes for the **PLASTICS** cycle and 30 minutes for all other cycles.

NOTE: Cannot be selected with **RINSE ONLY** cycle.

LOCK  You can lock the controls to prevent any selections from being made. Or you can lock the controls after you have started a cycle.

Children cannot accidentally start dishwasher by touching pads with this option selected.

To unlock the dishwasher controls, press and hold the **HEATED DRY** pad for 3 seconds. To lock the dishwasher, press and hold the **HEATED DRY** pad for 3 seconds. The light above the **LOCK** pad will turn off.

RESET To change a cycle after washing starts...

PDW8900 Series: Touch the **START/RESET** pad to cancel the cycle. The **START/RESET** light will flash while the water is pumped out if needed. This takes approximately 105 seconds.

PDW9700 and PDW9900 Series: Open the door slowly to prevent splash-out. Touch the **START/RESET** pad to cancel the cycle. If the **START/RESET** light is flashing, close the door until the water pumps out (this takes approximately 105 seconds) and the light stops flashing.

When the light stops flashing, the dishwasher can be reprogrammed and restarted.

5 Start

PDW8900 Series

Close the dishwasher door and select the cycle and desired enhancements. Touch the **START/RESET** pad to begin the cycle. Water fill begins immediately, and approximately 60 seconds later the wash action begins.

When the dishwasher door is fully closed, the control panel lights will display the last settings you selected. If you don't want to change any of the settings, simply touch the **START/RESET** pad to begin the cycle.

If the door is closed, the indicator lights will turn off if the **START/RESET** pad is not selected within 5 minutes. To activate the display, open and close the door or press any pad.

PDW9700 and PDW9900 Series

After selecting the cycle and desired enhancements, touch the **START/RESET** pad to ready the dishwasher to begin the cycle. Close the door to start the cycle or begin the **DELAY START** countdown. When the cycle starts, the water fill begins and approximately 60 seconds later the wash action begins.

The dishwasher will always display your last selection and enhancements. If you don't want to change the settings, simply touch the **START/RESET** pad to ready the dishwasher and close the door to begin the cycle.

Also, if a power failure occurs **NORMAL** and **HEATED DRY** will automatically be programmed. Make any new selections and touch the **START/RESET** pad to begin the new cycle.

If the door is opened, the indicator lights will turn off if the **START/RESET** pad is not selected within 5 minutes. To activate the display, open and close the door or touch any pad.

6 Clean

PDW8900 Series

The **CLEAN** light is illuminated when the selected cycle and enhancements are complete. The light will stay **ON** until a pad is pressed or the door is opened and closed.

PDW9700 and PDW9900 Series

The **CLEAN** light is illuminated and a double beep will sound when the selected cycle and enhancements are complete. You may remove the dishes at any time. Note the high-efficiency fan will run quietly for 30 minutes to 4 hours (depending on selected cycle) after the **CLEAN** light is illuminated to continue drying the dishes. This can be interrupted by opening the door and pressing any keypad.

NOTE: To turn off the double beep indicator (or re-activate it if it was previously disengaged), press the **HEATED DRY** pad 5 times within 3 seconds. A triple beep will sound to indicate the end-of-cycle beep option has been toggled.

NOTE: If you are not using the bulk dispenser and you want to turn the **LOW DETERGENT** LED light off, press the **ADDED HEAT** pad 5 times within 3 seconds. You will hear three beeps, then the light will go off. You can turn the light back on by pressing the **ADDED HEAT** pad 5 times within 3 seconds.

Flashing display lights.

Status Indicator Lights	What It Means
START/RESET	Cycle has been interrupted by pressing the START/RESET pad. Light will quit flashing after the dishwasher automatically drains out the water.

Recommended dishwasher products.

GE recommends the following products for use in its dishwashers:

- **Electrasol®** and **Cascade®** Dishwasher Detergents.
- **Jet Dry®** and **Cascade Rinse Aid®** to remove spots and prevent new film buildup on your dishes, glasses, flatware, cookware and plastic.
- **Cascade® Plastic Booster™** to remove red staining inside your dishwasher that can come from some tomato-based stains.
- Only use liquid dishwasher detergent in the Smart Dispenser.
- **Cerama Bryte®** Stainless Steel Appliance Cleaner to clean the stainless steel panel of GE and Profile™ stainless exterior dishwashers.
- **Jet Dry®** Dishwasher Cleaner to help remove some hard water mineral stains that can occur in hard water conditions.

Using the dishwasher.



Check the Water Temperature

The entering water should be at least 120°F and not more than 150°F for effective cleaning and to prevent dish damage. Check the water temperature with a candy or meat thermometer. Turn on the hot water faucet nearest the dishwasher, place the thermometer in a glass and let the water run continuously into the glass until the temperature stops rising.



Use Jet-Dry® or Cascade Rinse Aid® Rinse Agent

Jet-Dry® or **Cascade Rinse Aid®** rinse agent improves drying, removes spots and prevents new film buildup on your dishes, glasses, flatware, cookware and plastic.

Filling the Dispenser

The rinse agent dispenser holds 3.5 oz. of rinse agent. Under normal conditions, this will last approximately one month. Try to keep it full, but do not overfill.

- 1 Make sure the dishwasher door is fully open.
- 2 Turn the dispenser knob to the left and lift it out.
- 3 Add rinse agent until the indicator window looks full.
- 4 Clean up any spilled rinse agent with a damp cloth.
- 5 Replace the dispenser knob.

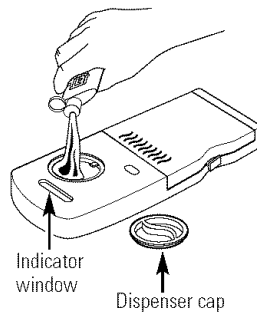

Rinse Aid Setting

The amount of rinse agent released into the final wash can be adjusted. The factory setting is at the midpoint. If there are rings of calcium (hard water) spots on dishes, try a higher setting. If there is foaming, use a lower setting.

To adjust the setting:

Remove the dispenser knob; then turn the adjuster counterclockwise to increase the amount of rinse agent.

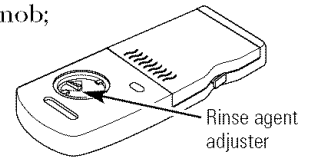

Dish Preparation Prior to Loading

- No prerinseing of normal food soil is required.
- Scrape off hard soils, including bones, toothpicks, skins and seeds.
- Remove large quantities of any remaining food.
- Remove leafy vegetables, meat trimmings and excessive amounts of grease or oil.
- Remove acidic food soils.



Forget to Add a Dish?

A forgotten dish can be added any time before the main wash.

- 1 Open the door slightly.
- 2 Wait until the water spray action stops. Steam may rise out of the dishwasher.
- 3 Add forgotten dishes.
- 4 Close the door.

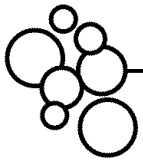

Proper Use of Detergent

Your dishwasher comes equipped with an automatic liquid dishwasher detergent dispenser (SmartDispense) and a Main Washer dispenser. You can use either of these dispensers but don't use both at the same time. If you use both dispensers at the same time it could damage your dishes.

The cover of the main wash section will open during the wash cycle. If you are using the Smart Dispenser, leave open the cover of the main wash section dispenser before starting the cycle.

Use only detergent specifically made for use in dishwashers. **Cascade®** and **Electrasol® Automatic Dishwashing Detergents** have been approved for use in all GE dishwashers.

Main Washer Dispenser

The amount of detergent to use depends on whether your water is *hard* or *soft*. With hard water, fill the main wash section and the pre-wash section completely. With soft water, fill both sections halfway. When using automatic dishwashing detergent tabs, simply place one tab in the main wash section and close.

Protect your dishes and dishwasher by contacting your water department and asking how hard your water is. Twelve or more grains is extremely hard water. A water softener is recommended. Without it, lime can build up in the water valve, which could stick while open and cause flooding. Too much detergent with soft water can cause a permanent cloudiness of glassware, called *etching*.

Filling the Dispenser

- 1 If the dispenser cover is closed, open the cover by depressing the cover latch.
- 2 Add detergent to the Main Wash section, as per guidelines.
- 3 Fill the Pre-wash section if water is extremely hard.
- 4 Close the dispenser cover.

It is normal for the cover to open partially when dispensing detergent.

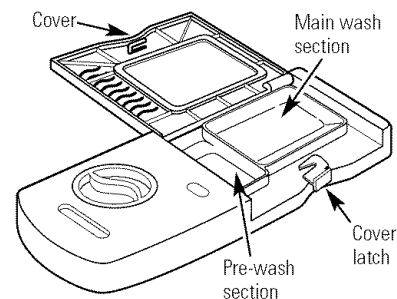

DO NOT USE HAND DISH DETERGENT

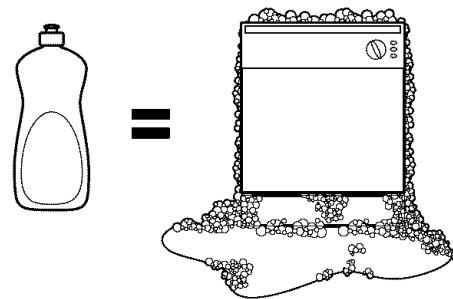

NOTE: Using a detergent that is not specifically designed for dishwashers will cause the dishwasher to fill with suds. During operation, these suds will spill out of the dishwasher vents, covering the kitchen floor and making the floor wet.

Because so many detergent containers look alike, store the dishwasher detergent in a separate space from all other cleaners. Show anyone who may use the dishwasher the correct detergent and where it is stored.

While there will be no lasting damage to the dishwasher, your dishes will not get clean using a dishwashing detergent that is not formulated to work with dishwashers.

Using the dishwasher.

SmartDispense Detergent Dispenser

This dishwasher contains a SmartDispense feature which automatically dispenses liquid dishwasher detergent into each cycle based on soil level and water hardness.

To utilize the SmartDispense Detergent Dispenser, it must first be filled. Any commercially available **liquid** dishwasher detergent can be used (i.e., **Electrosol®** and **Cascade®**).

▲ WARNING! Absolutely do not add powder detergent, tablets, or any liquid soap normally used for washing hands or dishes in a sink. Only use liquid detergent specifically designed for use in an automatic dishwasher.

To open the dispenser for filling, push down and turn the gray cap counterclockwise until the cap comes off.

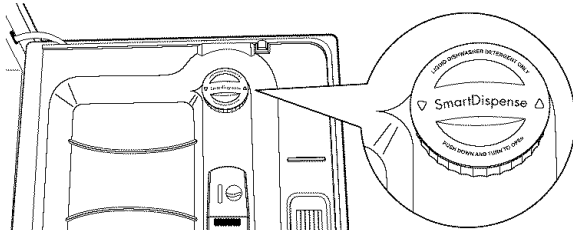

Set the door at a comfortable angle to fill the dispenser (or all the way open if you prefer).

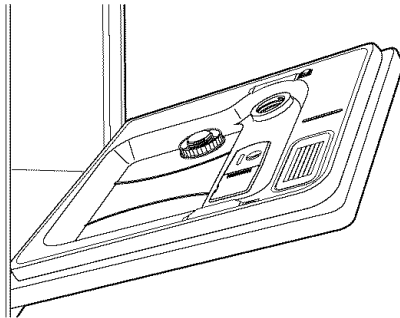

Aim the detergent bottle at the opening in the door and begin to fill.

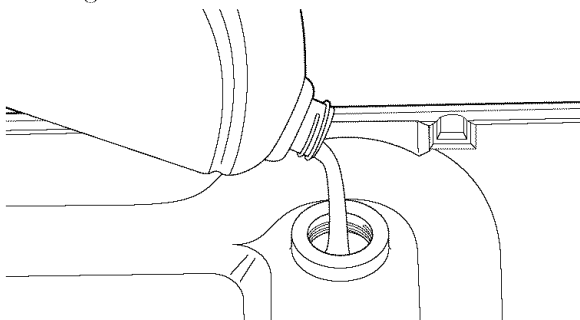

The dispenser will hold 45 oz of liquid dishwasher detergent (standard size bottle).

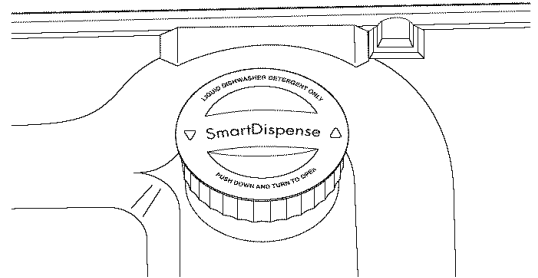

When full, return the cap to the access hole and turn counterclockwise until tight. If residue is left on the door, it will be washed off in the next cycle. Tighten cap until sealed.

An indicator light will turn on to notify you when the dispenser needs to be filled again. After filling, the light will not turn off until the door is closed. A full dispenser will last approximately 3 months for the average user.

STATUS	
Light will turn on → ○	Smart Dispense
●	LOW DETERGENT
●	SENSING
●	WASHING
●	DRYING
●	SANITIZED
●	CLEAN

DO NOT USE HAND DISH DETERGENT

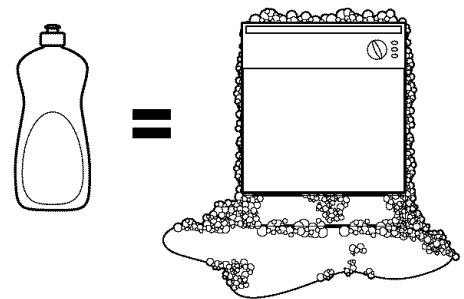

NOTE: Using a detergent that is not specifically designed for dishwashers will cause the dishwasher to fill with suds. During operation, these suds will spill out of the dishwasher vents, covering the kitchen floor and making the floor wet.

Because so many detergent containers look alike, store the dishwasher detergent in a separate space from all other cleaners. Show anyone who may use the dishwasher the correct detergent and where it is stored.

While there will be no lasting damage to the dishwasher, your dishes will not get clean using a dishwashing detergent that is not formulated to work with dishwashers.

Smart Dispense Detergent Dispenser (Cont.)

Before You Use Your SmartDispense Detergent Dispenser

Your dishwasher comes equipped with an automatic liquid dishwasher detergent dispenser (**SmartDispense**). Based on the soil level of your dishes and the hardness of your tap water, the **SmartDispense** feature will automatically introduce the optimal amount of detergent into your dishwasher during each cycle. The dispenser has the capacity to hold approximately 3 months of detergent (normal usage = 4 times per week) depending on usage. Thus, once the dispenser is filled, you will no longer need to put detergent into the dishwasher every time it is operated. An indicator light will signal when the dispenser is low and needs to be refilled. Once the light comes on, you will be able to use the dishwasher 4 to 7 times before the dispenser is completely empty.

Prior to the first use, the dishwasher needs to be calibrated for water hardness. Please follow directions below to calibrate the dishwasher to the hardness of your tap water.

Determine the hardness of your tap water

In the bag containing these instructions, you should find a water hardness strip package. Read the instructions on the package, remove the test strip and follow the instructions to determine the hardness level of your tap water. You will use this information to calibrate your dishwasher to dispense the optimal amount of detergent.

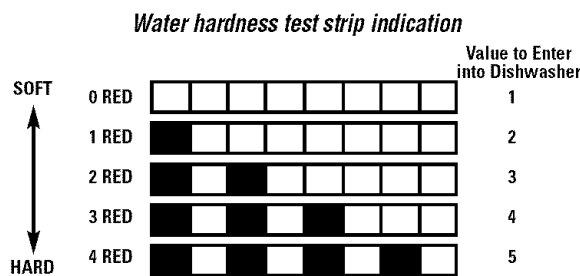

Water hardness calibration

From the standby mode (dishwasher not running a cycle and the panel lights are on), the consumer may enter the water hardness selection mode.

On dishwashers with a 12-button front control panel, press the **COOKWARE** and **DELAY HOURS** pads at the same time for 3 seconds to enter the water hardness calibration mode.

12-Button Front Control Panel

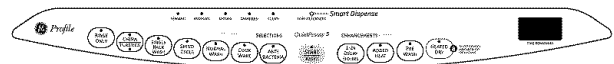

On dishwashers with a 7-button top control panel, press the “Up” and **DELAY HOURS** pad at the same time for 3 seconds to enter the water hardness calibration mode.

7-Button Top Control Panel



Once in the water hardness calibration mode, the 3-digit display will appear and display a number from **1** to **5**. If the water hardness has never before been entered, the display will show **1**. Otherwise, it will show the hardness previously entered. The “Up” or “Down” Arrow Pads, on the top control panel, may be pressed to change the value shown on the display. The **COOKWARE** and **NORMAL** pads, on the front control panel, may be pressed to change the value shown on the display. Set the value according to Table 1 below as determined from the water hardness test strip.

Press the **START/RESET** pad to return the control to Standby mode and save the last displayed value as the new water hardness value. Calibration is complete.

Loading the dishwasher racks.

For best dishwashing results, follow these loading guidelines. Features and appearance of racks and silverware baskets may vary from your model.

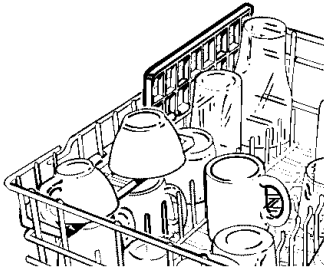

Upper Rack

Although the upper rack is for glasses, cups and saucers, pots and pans can be placed in this rack for effective cleaning. Cups and glasses fit best along the sides. This is also a secure place for dishwasher plastics.

The utility shelf (on some models) may be placed in the up or down position to add flexibility. A wine glass holder (on some models) secures wine glasses for best washability.

Some models have contoured metal cup shelves that can secure up to 12 wine glasses (as shown).

Some models have an Angled Rack System, which allows you to angle your dishes, such as coffee mugs, for better cleaning and quicker drying. To position the tines pull the lever forward then drop the tines into position, then release the lever.

Because wine glasses come in various sizes, after loading, slowly push in the rack to make sure they will clear the top of the dishwasher.

The upper rack is good for all kinds of odd-shaped utensils. Saucepans, mixing bowls and other items should be placed face down. Fold-down tines (on some models) provide flexibility for extra-large and hard-to-fit items.

Secure larger dishwasher-safe plastics over 2 tines when possible.

Make sure small plastic items are secure so they can't fall onto the heater.

Be sure that items do not protrude through the bottom of the rack and block rotation of the middle spray arm. This could result in poor wash performance for items in the upper rack.

Check to make sure that no items will block rotation of the wash arm.

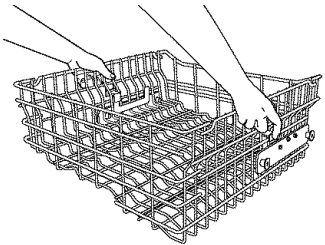
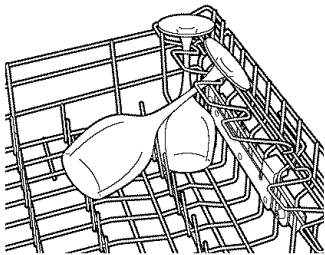
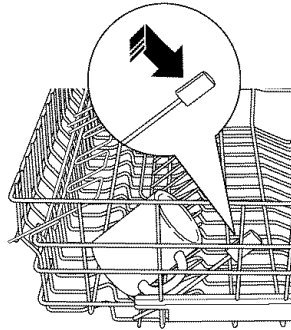

Adjustable Upper Rack

The standard position of your adjustable rack is "up" which allows for maximum clearance for your taller items in the lower rack. If you have taller wine glasses, tumblers or other items to place in the upper rack, you may want to adjust the rack to the lower position.

To lower the rack, support the weight of the rack with your hands as shown and press both finger pads about 1/4" toward the inside of the rack as indicated and guide the rack down to its lower position.

To raise the rack to the "up" position, pull up on the center of the rack side frame until the rack locks into place.

While using a **Single Rack Wash** cycle, if you have taller glasses, 10" plates, tumblers or other items, you may want to adjust your upper rack to a lower position.

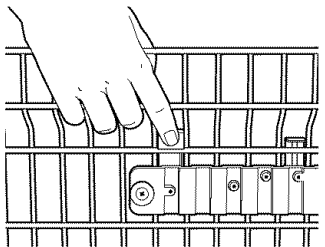

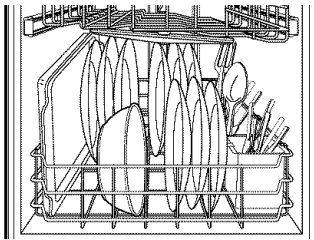

Lower Rack

The lower rack is best used for plates, saucers and cookware. Large items such as broiler pans and baking racks should go along the left-hand side. Load platters, pots and bowls along the sides, in corners or in the back. The soiled side of items should face the center of the rack. If necessary, oversized glasses and mugs can be placed in the lower rack to maximize loading flexibility.

Also, be careful not to let a portion of an item such as a pot or dish handle extend through the bottom rack. This could block the wash arm and cause poor washing results.

Fold-down tines (on some models) provide flexibility for extra-large and hard-to-fit items. The tines may be left in the up position or folded down to customize the lower rack.

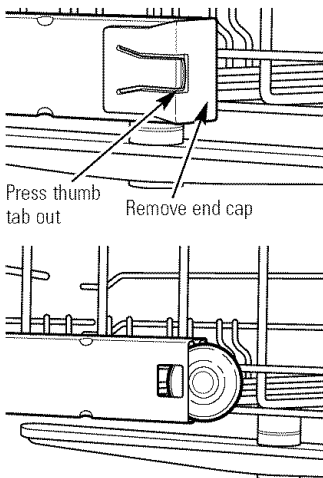

Removing the Upper Rack

You can remove the upper rack to allow space for large items in the lower rack.

To remove the upper rack:

- 1 Press thumb tab out and remove the front end caps on each side of the rail.
- 2 Pull the rack straight out and off the rails.
- 3 Replace the end caps.
- 4 Push the rails all the way back into the dishwasher.

- 5 Slide the shower nozzle attachment over the spout.

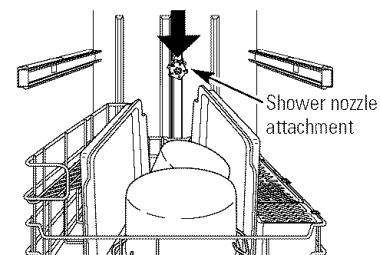

- 6 Then fill the lower rack and begin your cycle.

NOTE: Don't forget to remove the shower nozzle attachment before you replace the upper rack.

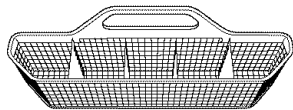

One-piece basket (on some models)

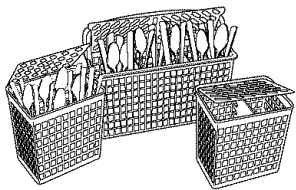

Three-piece basket (on some models)

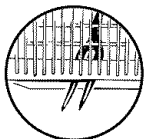

Don't let any item extend through bottom.

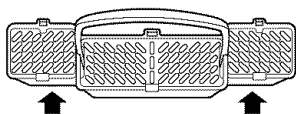

To remove end baskets, grasp the basket at opposite corners and slide apart.

Silverware Basket

To load flatware, simply push the adjustable handle to either side (on some models). Put flatware in the removable basket with fork and knife handles up to protect your hands. Place spoons in the basket with handles down. Mix knives, forks and spoons so they don't nest together. Distribute evenly. Small plastic items, such as measuring spoons and lids from small containers should go in the bottom of the silverware basket with the silverware on top.

The one-piece silverware basket (on some models) can be placed in the front, right side or back of the lower rack.

A variety of options is available regarding the three-piece silverware basket (on some models) in your dishwasher. The complete basket is designed to fit on the right side of the lower rack. Additionally, each end of the basket is removable to add loading flexibility to accommodate flatware and lower rack capacity needs.

The lids of both end and middle baskets (on some models) can be closed to contain small items. Long items can be placed on the utility shelf in the upper rack.

Loading the dishwasher racks.

Extra Rack Features (on some models)

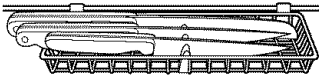

Cutlery Tray

The cutlery tray holds up to 4 large knives such as a carver, chef's knives, bread knife, etc., that are too tall to fit in the silverware basket.

Hook the tray onto the rear of the upper rack. Lay the knives between the guides (as shown).

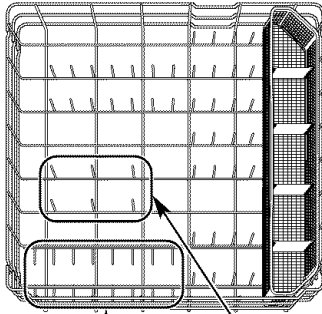

These tines fold down Large-bowl tines

Bowl Tines

The special large-bowl tines in the lower rack add flexibility to your loading pattern. They are useful for serving bowls or other large bowls.

To use the bowl tines, fold down the 2 rows of flex tines in front of the bowl tines and load bowls just as you would in the upper rack.

Loading place settings...

Follow these guidelines for loading 10 place settings. Features and appearance of racks and silverware baskets may vary from your model.

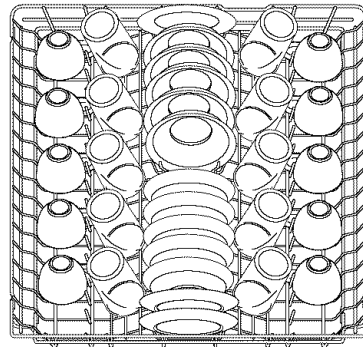

Upper Rack—10 place settings

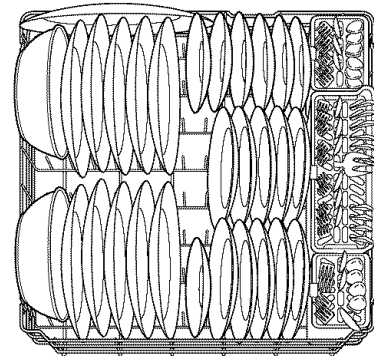

Lower Rack—10 place settings

Follow these guidelines for loading 12 place settings. Features and appearance of racks and silverware baskets may vary from your model.

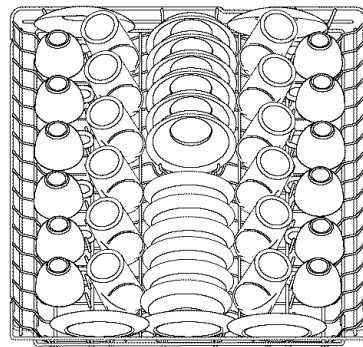

Upper Rack—12 place settings

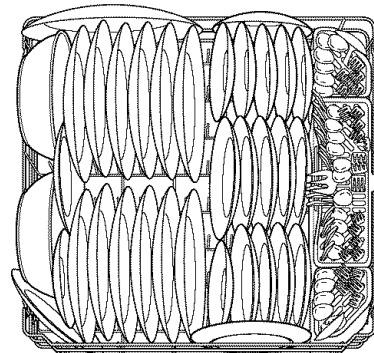

Lower Rack—12 place settings

You can change the appearance of your dishwasher to match your kitchen cabinets by ordering one of these optional accessories (PDW9700 Series models only):

- 1/4" Wood Panel Trim Kit
- 3/4" Trimless Wood Panel Kit

These accessories are available at extra cost (VISA, MasterCard or Discover cards accepted) by calling 800.626.2002. In Canada, please refer to the yellow pages for the nearest Camco service center. Specify accessory number when ordering.

NOTE: These accessories are not required for PDW9700 Series models which are designed specifically to accept custom panels.

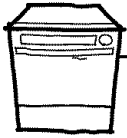

Descriptions of Optional Accessories

Wood Panel Trim Kit

This accessory contains *trim and instructions* for you to supply and install a 1/4" thick decorative wood door:

- GPF825B (Black)
- GPF825W (White)

Trimless Wood Panel Kit

This accessory contains *parts and instructions* for you to supply and install a 3/4" thick decorative wood door:

- GPF875B (Black)
- GPF875W (White)

Caring for the dishwasher.

To clean the control panel, use a lightly dampened cloth, then dry thoroughly. To clean the exterior, use a good appliance polish wax. Never use sharp objects, scouring pads or harsh cleaners on any part of the dishwasher.

Protect Against Freezing

If your dishwasher is left in an unheated place during the winter, ask a service technician to:

- 1 Cut off electrical power to the dishwasher. Remove fuses or trip circuit breaker.
- 2 Turn off the water supply and disconnect the water inlet line from the water valve.
- 3 Drain water from the water inlet line and water valve. (Use a pan to catch the water.)
- 4 Reconnect the water inlet line to the water valve.

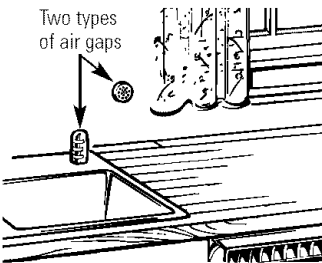

Does Your Dishwasher Have an Air Gap?

An air gap protects your dishwasher against water backing up into it if a drain clogs. The air gap is not a part of the dishwasher. It is not covered by your warranty. Not all plumbing codes require air gaps, so you may not have one.

The air gap is easy to clean.

- 1 Turn off the dishwasher and lift off the chrome cover.
- 2 Remove the plastic cap and clean with a toothpick.

Check the air gap any time your dishwasher isn't draining well.

Caring for the dishwasher.

Stainless Steel Panels

The stainless steel panels can be cleaned with **CERAMA BRYTE®** Stainless Steel Appliance Cleaner or a similar product using a clean, soft cloth.

You can order **CERAMA BRYTE®** Stainless Steel Appliance Cleaner through GE Parts by calling 800.626.2002. (For U.S. only.)

Stainless Steel Interior—Tub and Inner Door

The stainless steel used to make the dishwasher tub and inner door provides the highest reliability available in a GE dishwasher. If the dishwasher tub or inner door should be scratched or dented during normal use, they will not rust or corrode. These surface blemishes will not affect their function or durability.

Before you call for service...



Troubleshooting Tips

Save time and money! Review the charts on the following pages, or visit www.GEAppliances.com. You may not need to call for service.

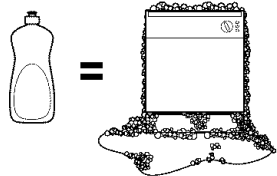
Problem	Possible Causes	What To Do
Control panel lights go off when you're setting controls	Time too long between touching of selected pads	<ul style="list-style-type: none"> Each pad must be touched within 5 minutes of the others. To relight, touch any pad again, or unlatch and relatch door.
Noise	Some of the sounds you'll hear are normal	<ul style="list-style-type: none"> Detergent cup opening. The motor stopping during the drying period. Water draining out of the tub immediately after you touch START/RESET pad. Drying fan running for 2–4 hours after CLEAN light is illuminated (Top Control Panel models only).
	Utensils are not secure in the rack or something small has dropped into the rack	<ul style="list-style-type: none"> Make sure everything is secured in dishwasher.
	Motor hums	<ul style="list-style-type: none"> Dishwasher has not been used on a regular basis. If you do not use your dishwasher often, set it to fill and pump out once every week. This will help keep the seal moist.
Detergent left in dispenser cups	Dishes are blocking the detergent cups	<ul style="list-style-type: none"> Reposition the dishes.
Water standing in the bottom of the tub	This is normal	<ul style="list-style-type: none"> A small amount of clean water around the outlet on the tub bottom at the back of the tub keeps the water seal lubricated.
Water won't pump out of the tub	Drain is clogged	<ul style="list-style-type: none"> If you have an air gap, clean it. Check to see if your kitchen sink is draining well. If not, you may need a plumber. If the dishwasher drains into a disposer, run disposer clear.
Suds	Correct detergent wasn't used	<ul style="list-style-type: none"> Use only automatic dishwasher detergents to avoid sudsing. Cascade® and Electrasol® dishwasher detergents have been approved for use in all GE dishwashers. To remove suds from the tub, open the dishwasher and let suds dissipate. Add 1 gallon of cold water to the tub. Pump out water by starting any cycle and then resetting the unit after 10 seconds (see <i>About the dishwasher control panel</i> section). Repeat if necessary.
		Rinse agent was spilled

Problem	Possible Causes	What To Do
Stained dishwasher parts	Detergent with colorant was used	<ul style="list-style-type: none"> Some detergents contain colorant (pigment or dyes) that will discolor the tub interior with extended use. Check the detergent cup for signs of any discoloration. If cup is discolored, change to detergent without any colorant. Cascade® and Electrasol® Dishwashing Detergents have been approved for use in all GE dishwashers.
	Some tomato-based foods can stain	<ul style="list-style-type: none"> Use of the RINSE ONLY cycle after adding the dish to the load can decrease the level of staining. GE also recommends Cascade® Plastic Booster™ to help remove these types of stains.
Dishes and flatware not clean	Low inlet water temperature	<ul style="list-style-type: none"> Make sure inlet water temperature is correct (see <i>Using the dishwasher</i> section).
	Water pressure is temporarily low	<ul style="list-style-type: none"> Turn on a faucet. Is water coming out more slowly than usual? If so, wait until pressure is normal before using your dishwasher.
	Air gap is clogged	<ul style="list-style-type: none"> Clean the air gap.
	Improper rack loading	<ul style="list-style-type: none"> Make sure large dishware does not block the detergent dispenser or the wash arms.
Spots and filming on glasses and flatware	No air gap or high drain loop	<ul style="list-style-type: none"> Verify that you have an air gap or a high drain loop.
	Extremely hard water	<ul style="list-style-type: none"> Use Jet-Dry® or Cascade Rinse Aid® rinse agent to remove spots and prevent new film buildup.
	Low inlet water temperature	<ul style="list-style-type: none"> To remove stubborn spots and pre-existing film from glassware:
	Overloading the dishwasher	<ol style="list-style-type: none"> 1 Remove all metal utensils from the dishwasher.
	Improper loading	<ol style="list-style-type: none"> 2 Do not add detergent.
	Old or damp powder detergent	<ol style="list-style-type: none"> 3 Select the COOKWARE cycle.
Rinse agent dispenser empty	<ol style="list-style-type: none"> 4 Start the dishwasher and allow to run for 18 to 22 minutes. Dishwasher will now be in the main wash. 	
Too little detergent	<ol style="list-style-type: none"> 5 Open the door and pour 2 cups (500 ml) of white vinegar into the bottom of the dishwasher. 6 Close the door and allow to complete the cycle. If vinegar rinse doesn't work: Repeat as above, except use 1/4 cup (60 ml) of citric acid crystals instead of vinegar. 	
Cloudiness on glassware	Combination of soft water and too much detergent	<ul style="list-style-type: none"> This is called <i>etching</i> and is permanent. To prevent this from happening, use less detergent if you have soft water. Wash glassware in the shortest cycle that will get them clean.
	Water temperature entering the dishwasher exceeds 150°F	<ul style="list-style-type: none"> Lower the water heater temperature.
Black or gray marks on dishes	Aluminum utensils have rubbed against dishes	<ul style="list-style-type: none"> Remove marks with a mild, abrasive cleaner.
Yellow or brown film on inside surfaces	Tea or coffee stains	<ul style="list-style-type: none"> Remove the stain by hand, using a solution of 1/2 cup bleach and 3 cups warm water. <p>CAUTION: Before cleaning interior, wait at least 20 minutes after a cycle for the heating element to cool down. Failure to do so can result in burns.</p>
	An overall yellow or brown film can be caused by iron deposits in water	<ul style="list-style-type: none"> A special filter in the water supply line is the only way to correct this problem. Contact your GE Dealer or other water softener company for water treatment options.

Before you call for service...



Troubleshooting Tips

Safety Instructions

Operating Instructions

Troubleshooting Tips

Consumer Support

Problem	Possible Causes	What To Do
White film on inside surfaces	Hard water minerals	<ul style="list-style-type: none"> • GE recommends Jet Dry® Dishwasher Cleaner to help remove some hard water and mineral stains. • For extreme staining, clean the interior by applying dishwasher detergent to a damp sponge. Wear rubber gloves. Do not use any type of cleanser other than those recommended or dishwasher detergent because it may cause foaming or sudsing. Cascade® and Electrasol® Automatic Dishwashing Detergents have been approved for use in all GE dishwashers.
Dishes don't dry	Low inlet water temperature Rinse agent dispenser is empty	<ul style="list-style-type: none"> • Make sure inlet water temperature is correct (see <i>Using the dishwasher</i> section). • Select HEATED DRY. • Check the rinse agent dispenser.
Dishwasher won't run	Fuse is blown, or the circuit breaker tripped Wall switch (some installations) is in the "off" position	<ul style="list-style-type: none"> • Replace fuse or reset circuit breaker. Remove any other appliances from the circuit. • Try resetting the START/RESET pad. • Check for a wall switch that the dishwasher might be connected to. A wall switch is required by electrical codes in some localities. Turn the switch "on" if it is "off."
Steam	This is normal	<ul style="list-style-type: none"> • Steam comes through the vent by the door latch during drying and when water is being pumped out.
Sanitized light does not illuminate at the end of the cycle (Anti-Bacteria cycle only)	The door was opened and the cycle was interrupted during or after the main wash portion The incoming water temperature was too low	<ul style="list-style-type: none"> • Do not interrupt the cycle anytime during or after main wash. • Raise the water heater temperature to 120°F.

GE Service Protection Plus™

GE, a name recognized worldwide for quality and dependability, offers you Service Protection Plus™—comprehensive protection on all your appliances—**No Matter What Brand!**

Benefits Include:

- Backed by GE
- All brands covered
- Unlimited service calls
- All parts and labor costs included
- No out-of-pocket expenses
- No hidden deductibles
- One 800 number to call

***We'll Cover Any Appliance.
Anywhere. Anytime.****

You will be completely satisfied with our service protection or you may request your money back on the remaining value of your contract. No questions asked. It's that simple.

Protect your refrigerator, dishwasher, washer and dryer, range, TV, VCR and much more—**any brand!** Plus there's no extra charge for emergency service and low monthly financing is available. Even icemaker coverage and food spoilage protection is offered. You can rest easy, knowing that all your valuable household products are protected against expensive repairs.

Place your confidence in GE and call us for more information in the U.S.
toll-free at **800.626.2224** and in Canada, toll-free at **888.261.2133**.

*All brands covered, up to 20 years old, in the continental U.S.

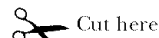

Please place in envelope and mail to:

General Electric Company
Warranty Registration Department
P.O. Box 32150
Louisville, KY 40232-2150

Consumer Product Ownership Registration

Dear Customer:

Thank you for purchasing our product and thank you for placing your confidence in us.

We are proud to have you as a customer!

Follow these three steps to protect your new appliance investment:

1 Complete and mail your Consumer Product Ownership Registration today. Have the peace of mind of knowing we can contact you in the unlikely event of a safety modification.

2 After mailing the registration below, store this document in a safe place. It contains information you will need should you require service. Our service number is 800.GE.CARES (800.432.2737) in the U.S. and 800.361.3400 in Canada.

3 Read your Owner's Manual carefully. It will help you operate your new appliance properly.

Model Number

Serial Number

Important: If you did not get a registration card with your product, detach and return the form below to ensure that your product is registered, or register online at www.GEAppliances.com. Canadian consumers, please use the mail-in card on page 19 in the French Language section.

 Cut here

Consumer Product Ownership Registration



Model Number

Serial Number

Mr. Ms. Mrs. Miss

First Name

Last Name

Street Address

Apt. #

E-mail Address*

City

State

Zip Code

Date Placed In Use
Month

Day

Year

Phone Number --



GE Appliances

GE Consumer & Industrial
Louisville, Kentucky
www.GEAppliances.com

* Please provide your e-mail address to receive, via e-mail, discounts, special offers and other important communications from GE Appliances (GEA).

Check here if you do not want to receive communications from GEA's carefully selected partners.

FAILURE TO COMPLETE AND RETURN THIS CARD DOES NOT DIMINISH YOUR WARRANTY RIGHTS.

For information about GEA's privacy and data usage policy, go to www.GEAppliances.com and click on "Privacy Policy" or call 800.626.2224.

Notes.

Safety Instructions

Operating Instructions

Troubleshooting Tips

Consumer Support

Notes.

Safety Instructions

Operating Instructions

Troubleshooting Tips

Consumer Support

GE Dishwasher Warranty.



All warranty service provided by our Factory Service Centers, or an authorized Customer Care® technician. To schedule service, on-line, 24 hours a day, visit us at www.GEAppliances.com, or call 800.GE.CARES (800.432.2737) in the United States. In Canada, call 1.800.361.3400.

Staple your receipt here.
Proof of the original purchase date is needed to obtain service under the warranty.

For The Period Of: GE Will Replace:

One Year From the date of the original purchase	Any part of the dishwasher which fails due to a defect in materials or workmanship. During this full one-year warranty , GE will also provide, free of charge , all labor and in-home service to replace the defective part.
Second Year From the date of the original purchase	Any part of the dishwasher which fails due to a defect in materials or workmanship. During this second-year limited warranty , you will be responsible for any labor or in-home service costs.
Five Years From the date of the original purchase	The dishwasher racks and the electronic control module if they should fail due to a defect in materials or workmanship. During this five-year limited warranty , you will be responsible for any labor or in-home service costs.
Lifetime of Product	The Stainless tub or door liner , if it fails to contain water due to a defect in materials or workmanship. During this full warranty , GE will also provide, free of charge , all labor and in-home service to replace the defective part.

What GE Will Not Cover (for customers in the United States):

- Service trips to your home to teach you how to use the product.
- Improper installation, delivery or maintenance.
- Failure of the product if it is abused, misused, or used for other than the intended purpose or used commercially.
- Replacement of house fuses or resetting of circuit breakers.
- Damage to the product caused by accident, fire, floods or acts of God.
- Incidental or consequential damage caused by possible defects with this appliance.
- Cleaning or servicing of the air gap device in the drain line.
- Damage caused after delivery including damage from items dropped on the door.

This warranty is extended to the original purchaser and any succeeding owner for products purchased for home use within the USA. Proof of original purchase date is needed to obtain service under the warranty. In Alaska, the warranty excludes the cost of shipping or service calls to your home.

Some states do not allow the exclusion or limitation of incidental or consequential damages. This warranty gives you specific legal rights, and you may also have other rights which vary from state to state. To know what your legal rights are, consult your local or state consumer affairs office or your state's Attorney General.

Warrantor: General Electric Company. Louisville, KY 40225

What Is Not Covered (for customers in Canada):

- Service trips to your home to teach you how to use the product.
- Improper installation.
If you have an installation problem, contact your dealer or installer. You are responsible for providing adequate electrical, exhausting and other connecting facilities.
- Failure of the product if it is abused, misused, or used for other than the intended purpose or used commercially.
- Replacement of house fuses or resetting of circuit breakers.
- Damage to the product caused by accident, fire, floods or acts of God.
- Damage caused after delivery including damage from items dropped on the door.

WARRANTOR IS NOT RESPONSIBLE FOR CONSEQUENTIAL DAMAGES.

Warrantor: CAMCO INC.

Consumer Support



GE Appliances Website

In the U.S.: www.GEAppliances.com

Have a question or need assistance with your appliance? Try the GE Appliances Website 24 hours a day, any day of the year! For greater convenience and faster service, you can now download Owner's Manuals, order parts, catalogs, or even schedule service on-line. You can also "Ask Our Team of Experts™" your questions, and so much more... **In Canada:** www.geappliances.ca

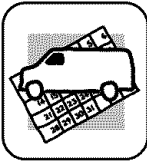

Schedule Service

In the U.S.: www.GEAppliances.com

Expert GE repair service is only one step away from your door. Get on-line and schedule your service at your convenience 24 hours any day of the year! Or call 800.GE.CARES (800.432.2737) during normal business hours. **In Canada,** call 1.800.361.3400

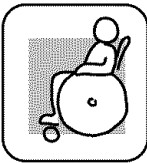

Real Life Design Studio

In the U.S.: www.GEAppliances.com

GE supports the Universal Design concept—products, services and environments that can be used by people of all ages, sizes and capabilities. We recognize the need to design for a wide range of physical and mental abilities and impairments. For details of GE's Universal Design applications, including kitchen design ideas for people with disabilities, check out our Website today. For the hearing impaired, please call 800.TDD.GEAC (800.833.4322).

In Canada, contact: Manager, Consumer Relations, Camco, Inc.
Suite 310, 1 Factory Lane
Moncton, N.B. E1C 9M3



Extended Warranties

In the U.S.: www.GEAppliances.com

Purchase a GE extended warranty and learn about special discounts that are available while your warranty is still in effect. You can purchase it on-line anytime, or call 800.626.2224 during normal business hours. GE Consumer Home Services will still be there after your warranty expires. **In Canada,** call 1.888.261.2133

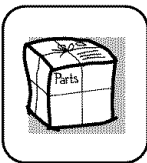

Parts and Accessories

In the U.S.: www.GEAppliances.com

Individuals qualified to service their own appliances can have parts or accessories sent directly to their homes (VISA, MasterCard and Discover cards are accepted). Order on-line today, 24 hours every day or by phone at 800.626.2002 during normal business hours.

Instructions contained in this manual cover procedures to be performed by any user. Other servicing generally should be referred to qualified service personnel. Caution must be exercised, since improper servicing may cause unsafe operation.

Customers **in Canada** should consult the yellow pages for the nearest Camco service center.



Contact Us

In the U.S.: www.GEAppliances.com

If you are not satisfied with the service you receive from GE, contact us on our Website with all the details including your phone number, or write to: General Manager, Customer Relations
GE Appliances, Appliance Park
Louisville, KY 40225

In Canada: www.geappliances.ca, or write to: Director, Consumer Relations, Camco, Inc.
Suite 310, 1 Factory Lane
Moncton, N.B. E1C 9M3



Register Your Appliance

In the U.S.: www.GEAppliances.com

Register your new appliance on-line—at your convenience! Timely product registration will allow for enhanced communication and prompt service under the terms of your warranty, should the need arise. You may also mail in the pre-printed registration card included in the packing material. **In Canada:** www.geappliances.ca