



GAS RANGE

Use & Care Guide

ESTUFA DE GAS

Manual del Usuario

Model, modelo 790.79613

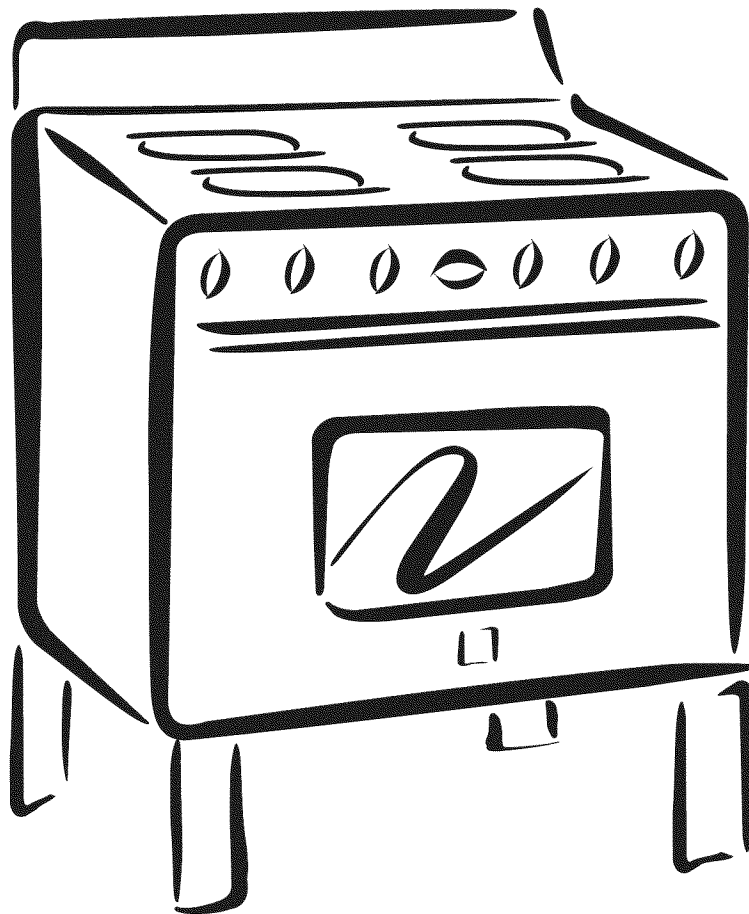

ENGLISH

ESPAÑOL

Table of Contents

Slide-in Range Warranty	2	Before Setting Oven Controls	12-13
IMPORTANT SAFETY INSTRUCTIONS	3-5	Air Circulation in the Oven	13
Product Record	5	Control Button Features	14
Serial Plate Location	5	Setting the Clock	14
Conversion to Liquefied Petroleum Gas (or L.P. Gas)	5	Setting Oven Controls	15-19
Protection Agreements	6	Self-Cleaning	20-21
Range Features	7	Adjusting Oven Temperature	21
Before Setting Surface Controls	8	General Care & Cleaning	22-26
Setting Surface Controls	9-10	Before You Call	27-29
Surface Cooking	11-12	Sears Service	30

Please carefully read and save these instructions

This Use & Care Manual contains general operating instructions for your appliance and feature information for several models. Your product **may not** have all the described features. The graphics shown are representative. The graphics on your appliance may not look exactly like those shown. Common sense and caution must be practiced when installing, operating and maintaining any appliance.

Kenmore PRO Limited Warranty

When installed, operated and maintained according to all instructions supplied with this product, if this appliance fails due to a defect in material or workmanship within one year from the date of purchase, call 1-800-4-MY-HOME® to arrange for free repair.

For five years from the date of purchase, if the cooktop glass fails due to thermal shock or the cooktop elements are defective, call 1-800-4-MY-HOME® to arrange for free part replacement. After the first year from the purchase date, you must pay the labor cost of part installation.

This warranty applies for only 90 days from the date of purchase if this appliance is ever used for other than private family purposes.

This warranty covers only defects in material and workmanship. Sears will NOT pay for:

1. Cracks in a ceramic glass cooktop that are not a result of thermal shock.
2. Stains and scratches on a ceramic glass cooktop resulting from accident or improper operation or maintenance.
3. Expendable items that can wear out from normal use, including but not limited to filters, belts, light bulbs, and bags.
4. A service technician to instruct the user in correct product installation, operation or maintenance.
5. A service technician to clean or maintain this product.
6. Damage to or failure of this product if it is not installed, operated or maintained according to the all instructions supplied with the product.
7. Damage to or failure of this product resulting from accident, abuse, misuse or use for other than its intended purpose.
8. Damage to or failure of this product caused by the use of detergents, cleaners, chemicals or utensils other than those recommended in all instructions supplied with the product.
9. Damage to or failure of parts or systems resulting from unauthorized modifications made to this product.

Disclaimer of implied warranties; limitation of remedies

Customer's sole and exclusive remedy under this limited warranty shall be product repair as provided herein. Implied warranties, including warranties of merchantability or fitness for a particular purpose, are limited to one year or the shortest period allowed by law. Sears shall not be liable for incidental or consequential damages. Some states and provinces do not allow the exclusion or limitation of incidental or consequential damages, or limitation on the duration of implied warranties of merchantability or fitness, so these exclusions or limitations may not apply to you.

This warranty applies only while this appliance is used in the United States or Canada.

This warranty gives you specific legal rights, and you may also have other rights which vary from state to state.

Sears, Roebuck and Co., Hoffman Estates, IL 60179

Sears Canada Inc., Toronto, Ontario, Canada M5B 2B8

Important Safety Instructions



Read all instructions before using this appliance.

Save these instructions for future reference.

This manual contains many important safety messages. Always read and obey all safety messages.

The safety symbol  calls your attention to safety messages that inform you of hazards that can kill or hurt you or others, or cause damage to the product.

⚠ WARNING Indicates an imminently hazardous situation which, if not avoided may result in death or serious injury.

⚠ CAUTION Indicates an imminently hazardous situation which, if not avoided may result in minor or moderate injury, or product damage.

All safety messages will identify the hazard, tell you how to reduce the chance of injury, and tell you what can happen if the instructions are not followed.

⚠ WARNING If the information in this manual is not followed exactly, a fire or explosion may result causing property damage, personal injury or death.

FOR YOUR SAFETY:

- Do not store or use gasoline or other flammable vapors and liquids in the vicinity of this or any other appliance.
- **WHAT TO DO IF YOU SMELL GAS:**
 - Do not try to light any appliance.
 - Do not touch any electrical switch; do not use any phone in your building.
 - Immediately call your gas supplier from a neighbor's phone. Follow the gas supplier's instructions.
 - If you cannot reach your gas supplier, call the fire department.
- Installation and service must be performed by a qualified installer, servicer or the gas supplier.



⚠ WARNING

- All ranges can tip.
- Injury to persons could result.
- Install anti-tip device packed with range.
- See Installation Instructions.



⚠ WARNING

To reduce the risk of tipping, the range must be secured by properly installed anti-tip bracket(s) provided with the range. To check if the bracket(s) is installed properly, remove the lower panel or storage drawer and verify that the anti-tip bracket(s) is engaged. Refer to the Installation Instructions for proper anti-tip bracket(s) installation.

- **Remove all tape and packaging before using the range.** Destroy the carton and plastic bags after unpacking the range. Never allow children to play with packaging material.
- **Proper Installation—Be sure your appliance is properly installed and grounded by a qualified technician in accordance with the National Fuel Gas Code ANSI Z223.1 / NFPA 54, and National Electrical Code ANSI/NFPA No. 70—latest edition, and local code requirements.** Install only per installation instructions provided in the literature package for this range.
- **In case of an emergency, know how to disconnect the electrical power to the appliance at the circuit breaker or fuse box and how to turn off the gas supply at the main shutoff valve.**
- **User Servicing—Do not repair or replace any part of the appliance unless specifically recommended in the manuals.** All other servicing should be done only by a qualified technician to reduce the risk of personal injury and damage to the cooktop. Sears Parts & Repair is the recommended repair service for this appliance.
- **Never modify or alter the construction of a range by removing leveling legs, panels, wire covers, anti-tip brackets/screws, or any other part of the product.**

⚠ WARNING Stepping, leaning or sitting on the door or drawer of this range can result in serious injuries and also cause damage to the range. Do not allow children to climb or play around the range. The weight of a child on an open door may cause the range to tip, resulting in serious burns or other injury.

⚠ WARNING Do not use the oven for storage.

⚠ CAUTION Do not store items of interest to children in the cabinets above a range. Children climbing on the range to reach items could be seriously injured.

⚠ WARNING NEVER use this appliance as a space heater to heat or warm the room. Doing so may result in carbon monoxide poisoning and overheating of the oven.

- **Storage in or on Appliance—Flammable materials should not be stored in an oven, near surface burners.** This includes paper, plastic and cloth items, such as cookbooks, plasticware and towels, as well as flammable liquids. Do not store explosives, such as aerosol cans, on or near the appliance. Flammable materials may explode and result in fire or property damage.
- **Do not leave children alone—Children should not be left alone or unattended in the area where appliance is in use.** They should never be allowed to sit or stand on any part of the appliance.
- **DO NOT TOUCH SURFACE BURNERS, AREAS NEAR THESE BURNERS, OVEN HEATING ELEMENTS OR INTERIOR SURFACES OF THE OVEN.** Both surface burners and oven heating elements may be hot even though they are dark in color. Areas near surface burners may become hot enough to cause burns. During and after use, do not touch, or let clothing or other flammable materials touch these areas until they have had sufficient time to cool. Among these areas are the cooktop, surfaces facing the cooktop, the oven vent openings and surfaces near these openings, oven door and window.
- **Wear proper apparel—Loose-fitting or hanging garments should never be worn while using the appliance.** Do not let clothing or other flammable materials contact hot surfaces.

ENGLISH

Important Safety Instructions

- **Do not use water or flour on grease fires—Smother the fire with a pan lid, or use baking soda, a dry chemical or foam-type extinguisher.**
- **When heating fat or grease, watch it closely.** Fat or grease may catch fire if allowed to become too hot.

⚠ WARNING In case of fire or gas leak, be sure to turn off the main gas shutoff valve.

- **Use only dry potholders—Moist or damp potholders on hot surfaces may result in burns from steam.** Do not let potholders touch hot heating elements. Do not use a towel or other bulky cloth instead of a potholder.
- **Do not heat unopened food containers—Buildup of pressure may cause container to burst and result in injury.**
- **Remove the oven door from any unused range if it is to be stored or discarded.**

IMPORTANT—Do not attempt to operate the oven during a power failure. If the power fails, always turn the oven off. If the oven is not turned off and the power resumes, the oven may begin to operate again. Food left unattended could catch fire or spoil.

⚠ WARNING Use proper flame size—Adjust flame size so it does not extend beyond the edge of the utensil. The use of undersized utensils will expose a portion of the burner flame to direct contact and may result in ignition of clothing. Proper relation of utensil to flame will also improve cooking efficiency.

⚠ WARNING Do not use stove top grills on the burner grates of sealed gas burners. If you use a stove top grill on a sealed gas burner, it will cause incomplete combustion and can result in exposure to carbon monoxide levels above allowable current standards. This can be hazardous to your health.

⚠ CAUTION Electronic controllers can be damaged by cold temperatures. When you use your appliance for the first time, or if it has not been used for a long period of time, make sure that it has been exposed to a temperature above 0°C/32°F for at least 3 hours before connecting it to the power supply.

IMPORTANT INSTRUCTIONS FOR USING YOUR COOKTOP

- **Know which knob controls each surface heating unit.** Always turn the knob to the LITE position when igniting the burners. Visually check that burner has lit. Then adjust the flame so it does not extend beyond the edge of the utensil.
- **Use proper pan size.** This appliance is equipped with one or more surface burners of different sizes. Select utensils having flat bottoms large enough to cover the surface burner. The use of undersized utensils will expose a portion of the surface burner to direct contact and may result in ignition of clothing. Proper relationship of utensil to the surface burner will also improve efficiency.
- **Utensil handles should be turned inward and not extend over adjacent surface burners—**To reduce the risk of burns, ignition of flammable materials, and spillage due to unintentional contact with the utensil. The handle of the utensil should be positioned so that it is turned inward, and does not extend over adjacent surface burners.

- **Never leave surface burners unattended at high heat settings—**Boilovers cause smoking and greasy spillovers that may ignite, or a pan that has boiled dry may melt.

⚠ WARNING Never cover any slots, holes or passages in the oven bottom or cover an entire rack with materials such as aluminum foil. Doing so blocks air flow through the oven and may cause carbon monoxide poisoning. Aluminum foil linings may also trap heat, causing a fire hazard.

- **Glazed cooking utensils—**Only certain types of glass, glass/ceramic, ceramic, earthenware, or other glazed utensils are suitable for rangetop service without breaking due to the sudden change in temperature. Check the manufacturer's recommendations for rangetop use.
- **Do not use decorative surface burner covers.** If a burner is accidentally turned on, the decorative cover will become hot and possibly melt. Burns will occur if the hot covers are touched. Damage may also be done to the cooktop or burners because the covers may cause overheating. Air will be blocked from the burner and cause combustion problems.

FOR GLASS COOKTOPS ONLY

- **Do not clean or operate a broken cooktop—**If cooktop should break, cleaning solutions and spillovers may penetrate the broken cooktop and create a risk of electric shock. Contact a qualified technician immediately.
- **Clean cooktop glass with caution—**If a wet sponge or cloth is used to wipe spills on a hot cooking area, be careful to avoid a steam burn. Some cleaners can produce harmful fumes if applied to a hot surface.
- **Avoid scratching the cooktop glass with sharp objects.**

IMPORTANT INSTRUCTIONS FOR USING YOUR OVEN

- **Use care when opening oven door—**Stand to the side of the range when opening the door of a hot oven. Let hot air or steam escape before you remove or replace food in the oven.
- **Keep oven vent ducts unobstructed.** The oven vent is located under the cooktop. Touching the surfaces in this area when the oven is operating may cause severe burns. Also, do not place plastic or heat-sensitive items on or near the oven vent. These items could melt or ignite.
- **Placement of oven racks.** Always place oven racks in desired location while oven is cool. If rack must be moved while oven is hot use extreme caution. Use potholders and grasp the rack with both hands to reposition. Do not let potholders contact the hot heating elements in the oven. Remove all utensils from the rack before moving.
- **Do not use the broiler pan without its insert.** The broiler pan and its insert allow dripping fat to drain and be kept away from the high heat of the broiler.
- **Do not cover the broiler insert with aluminum foil.** Exposed fat and grease could ignite.
- **Do not touch a hot light bulb with a damp cloth.** Doing so could cause the bulb to break. Disconnect the appliance or turn off the power to the appliance before removing and replacing light bulb.

Important Safety Instructions

IMPORTANT INSTRUCTIONS FOR CLEANING YOUR RANGE

- **Clean the range regularly to keep all parts free of grease that could catch fire.** Exhaust fan ventilation hoods and grease filters should be kept clean. Do not allow grease to accumulate on hood or filter. Greasy deposits in the fan could catch fire. When you are flaming food under the hood, turn the fan on. Refer to the hood manufacturer's instructions for cleaning.

SELF CLEANING OVENS

- **In the self-Cleaning cycle only clean the parts listed in this Use and Care Guide.** Before self cleaning the

oven, remove the broiler pan and any utensils or foods from the oven.

- **Do not use oven cleaners**—No commercial oven cleaner or oven liner protective coating of any kind should be used in or around any part of the oven.
- **Do not clean door gasket**—The door gasket is essential for a good seal. Care should be taken not to rub, damage or move the gasket.
- **Remove oven racks.** Oven racks color will change if left in the oven during a self-cleaning cycle.

⚠ CAUTION The health of some birds is extremely sensitive to the fumes given off during the self-cleaning cycle of the range. Move the birds to another well ventilated room.

Important Safety Notice

The California Safe Drinking Water and Toxic Enforcement Act requires the Governor of California to publish a list of substances known to the state to cause cancer, birth defects or other reproductive harm, and requires businesses to warn customers of potential exposure to such substances.

Grounding Instructions

For personal safety, the cooktop must be properly grounded. For maximum safety, the power cord must be plugged into an electrical outlet that is correctly polarized and properly grounded.

DO NOT operate the cooktop using a 2-prong adapter or an extension cord. If a 2-prong wall receptacle is the only available outlet, it is the personal responsibility of the consumer to have it replaced with a properly grounded 3-prong wall receptacle installed by a qualified electrician.

See the **INSTALLATION INSTRUCTIONS** packaged with this cooktop for complete installation and grounding instructions.

⚠ WARNING This appliance is equipped with a 3-prong grounding plug for your protection against shock hazard and should be plugged directly into a properly grounded receptacle. **DO NOT** cut or remove the grounding prong from this plug.

⚠ WARNING Personal injury or death from electrical shock may occur if the range is not installed by a qualified installer or electrician.

Grounding type wall receptacle

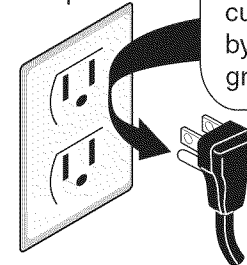

Do not, under any circumstances, cut, remove, or bypass the grounding prong.

Power supply cord with 3-prong grounding plug

⚠ WARNING Avoid fire hazard or electrical shock. **DO NOT** use an adapter plug, an extension cord, or remove grounding prong from electrical power cord. Failure to follow this warning can cause serious injury, fire or death.

ENGLISH

Conversion to Liquefied Petroleum Gas (or L. P. Gas)

This natural gas range is designed to allow for conversion to Liquefied Petroleum (L. P.) Gas.

Only a qualified service agent should perform the L. P. conversion. Contact the local gas provider for conversion. A L. P. Conversion Kit is supplied with this range and is located on the main back of the range. The kit contains installation instructions which must be read before and followed carefully when installing the kit.

⚠ WARNING To avoid serious injury, any additions, changes or conversions required in order for this appliance to satisfactorily meet the application needs must be made by a qualified service agent.

Product Record

In this space below, record the date of purchase, model and serial number of your product. You will find the model and serial number printed on the serial plate.

Model No. **790.79613** _____

Serial No. _____

Date of purchase _____

Save these instructions and your sales receipt for future reference.

Serial Plate Location

You will find the model and serial number printed on the serial plate.

Remember to record the serial number for future reference.

Serial Plate Location
A serial plate is located on the lower trim and visible when the oven door is opened.

Serial Plate Location
A serial plate is located at the back of the unit.

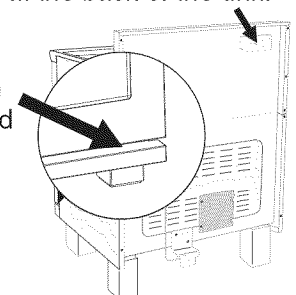

Master Protection Agreements

Congratulations on making a smart purchase. Your new Kenmore® product is designed and manufactured for years of dependable operation. But like all products, it may require preventive maintenance or repair from time to time. That's when having a Master Protection Agreement can save you money and aggravation.

The Master Protection Agreement also helps extend the life of your new product. Here's what the Agreement* includes:

- ✓ **Parts and labor** needed to help keep products operating properly **under normal use**, not just defects. Our coverage goes **well beyond the product warranty**. No deductibles, no functional failure excluded from coverage – **real protection**.
- ✓ **Expert service** by a force of more than **10,000 authorized Sears service technicians**, which means someone you can trust will be working on your product.
- ✓ **Unlimited service calls and nationwide service**, as often as you want us, whenever you want us.
- ✓ **"No-lemon" guarantee** – replacement of your covered product if four or more product failures occur within twelve months.
- ✓ **Product replacement** if your covered product can't be fixed.
- ✓ **Annual Preventive Maintenance Check** at your request – no extra charge.
- ✓ **Fast help by phone** – we call it **Rapid Resolution** – phone support from a Sears representative on all products. Think of us as a "talking owner's manual".
- ✓ **Power surge protection** against electrical damage due to power fluctuations.
- ✓ **\$250 Food Loss Protection** annually for any food spoilage that is the result of mechanical failure of any covered refrigerator or freezer.
- ✓ **Rental reimbursement** if repair of your covered product takes longer than promised.
- ✓ **10% discount** off the regular price of any non-covered repair service and related installed parts.

Once you purchase the Agreement, a simple phone call is all that it takes for you to schedule service. You can call anytime day or night, or schedule a service appointment online.

The Master Protection Agreement is a risk free purchase. If you cancel for any reason during the product warranty period, we will provide a full refund. Or, a prorated refund anytime after the product warranty period expires. Purchase your Master Protection Agreement today!

Some limitations and exclusions apply. For prices and additional information in the U.S.A. call 1-800-827-6655.

*** Coverage in Canada varies on some items. For full details call Sears Canada at 1-800-361-6665.**

Sears Installation Service

For Sears professional installation of home appliances, garage door openers, water heaters, and other major home items, in the U.S.A. or Canada call **1-800-4-MY-HOME®**.

Acuerdos maestros de protección

Enhorabuena por haber hecho una compra inteligente. Su nuevo producto Kenmore® está diseñado y fabricado para brindarle años de funcionamiento fiable. Pero, como cualquier producto, puede necesitar mantenimiento preventivo o reparaciones periódicas. Es por eso que tener un Acuerdo maestro de protección podría ahorrarle dinero y molestias.

El Acuerdo maestro de protección también sirve para prolongar la durabilidad de su nuevo producto. El acuerdo* incluye lo siguiente:

- ✓ **Piezas y mano de obra** necesarias para contribuir a mantener el funcionamiento adecuado de los productos **utilizados en condiciones normales de uso**, no sólo en caso de defectos de los productos. Nuestra cobertura va **mucho más allá que la garantía del producto**. No se aplican deducibles ni exclusiones por fallas del funcionamiento: es decir, **verdadera protección**.
- ✓ **Servicio técnico por expertos** (más de **10000 técnicos autorizados de Sears**), lo cual significa que quien repare o realice el mantenimiento de su producto será un profesional de confianza. **Servicio técnico a escala nacional y número ilimitado de llamadas de solicitud de servicio técnico**: se puede poner en contacto con nosotros cuantas veces lo desee y cuando lo desee. **Garantía "sin sorpresas"**: se reemplaza el producto cubierto por el acuerdo si ocurren cuatro o más fallas del producto en un periodo de 12 meses.
- ✓ **Reemplazo del producto**: en caso de que no se pueda reparar el producto cubierto por el acuerdo.
- ✓ **Revisión anual preventiva de mantenimiento del producto**: puede solicitarla en cualquier momento, sin costo alguno.
- ✓ **Rápida asistencia telefónica**, la cual denominamos **Solución rápida**: es decir, asistencia telefónica a través de cualquiera de nuestros representantes de Sears, sobre cualquiera de nuestros productos. Piense en nosotros como en un "manual parlante del usuario".
- ✓ **Protección contra fallas eléctricas**, contra daños debidos a fluctuaciones de la corriente eléctrica.
- ✓ **\$250 al año para cubrir cualquier posible deterioro de alimentos** que haya tenido que desechar debido a una falla mecánica de cualquiera de nuestros refrigeradores o congeladores cubiertos por este acuerdo.
- ✓ **Devolución de gastos de alquiler de electrodomésticos** si la reparación de su producto asegurado toma más que el tiempo prometido.
- ✓ **10% de descuento** aplicable tanto a los costos del servicio de reparación, como de las piezas instaladas relacionadas que no hayan quedado cubiertos por este acuerdo.

Una vez que haya realizado el pago de este acuerdo, bastará una simple llamada telefónica para concertar una visita de servicio. Puede llamar a cualquier hora del día o de la noche, o bien concertar una visita de servicio por Internet.

La adquisición del Acuerdo maestro de protección es una inversión exenta de riesgos. Si por cualquier motivo decide cancelar dicho acuerdo durante el periodo de garantía del producto, le haremos un reintegro total del valor. O bien un importe proporcional si cancela el acuerdo en cualquier otro momento posterior al vencimiento del periodo de garantía del producto. ¡Adquiera hoy mismo su Acuerdo maestro de protección!

Algunas limitaciones y exclusiones podrían aplicarse. Para solicitar precios e información adicional, llame al 1-800-827-6655 (en los EE.UU.).

*** La cobertura en Canadá varía en el caso de algunos artículos. Para obtener detalles completos al respecto, llame al 1-800-361-6665 de Sears de Canadá.**

Servicio de instalación de Sears

Para solicitar la instalación por profesionales de Sears de electrodomésticos, abridores de puertas de garaje, calentadores de agua y otros artículos de uso prioritario en el hogar, **llame al 1-800-4-MY-HOME** en los EE.UU. o Canadá.

Range Features

Your Range Features At a Glance

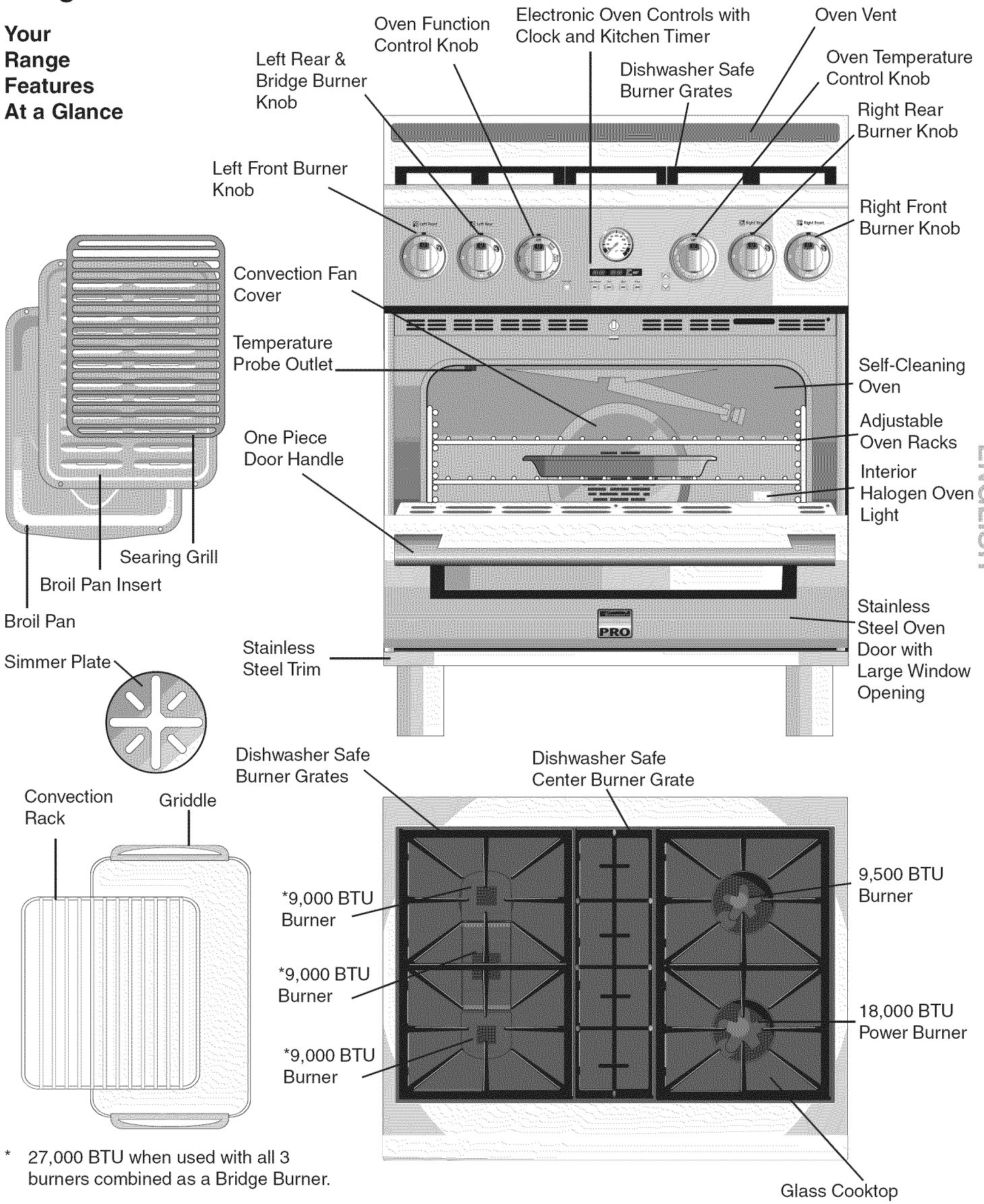

ENGLISH

* 27,000 BTU when used with all 3 burners combined as a Bridge Burner.

Before Setting Surface Controls

Assembly of the Surface Burner Heads, Burner Caps and Burner Grates

It is very important to make sure that all of the Surface Burner Heads, Surface Burner Caps and Surface Burner Grates are installed correctly and at the correct locations.

1. Be sure to follow the Installation Instructions when installing your new range.
2. Remove all packing tape from cooktop and burner caps. Remove Bridge Burner Caps and Bridge Burner Heads (See Figure 3).
3. Discard all packing material located under Bridge Burner Heads (if applicable).
4. Replace Bridge Burner Caps. These include one Bridge Burner Center Cap (rectangular shaped) and the two Bridge Burner End Caps (The Bridge Burner End Caps will fit either the front or rear Bridge Burner Head locations). Make sure that the tabs located under the Bridge Burner Caps fall into the slots located in the Bridge Burner Head (See arrows in Figure 3) and that all the Bridge Burner Caps lie flat and evenly on the Bridge Burner Head.
5. Unpack the grates and place them on the cooktop as shown. NOTE: Do not force End Burner Grates down on cooktop. Position Burner Grates on cooktop and check that all the Burner Grate legs lie on the glass surface.

REMEMBER — DO NOT ALLOW SPILLS, FOOD, CLEANING AGENTS OR ANY OTHER MATERIAL

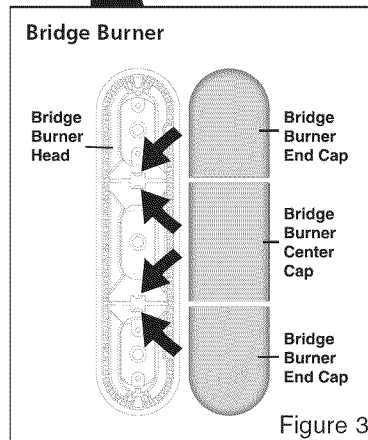
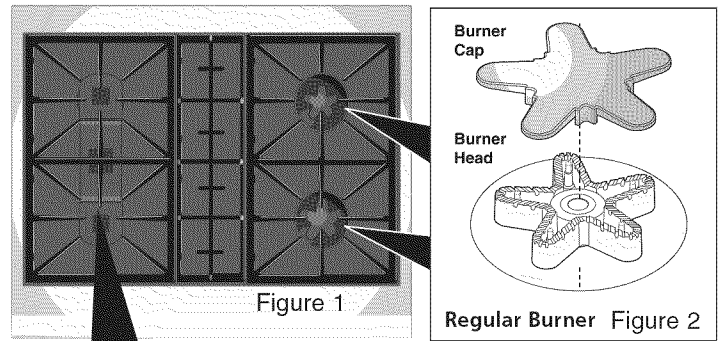

Locations of the Gas Surface Burners (See Figure 4)

The **STANDARD** sized burner are used for most surface cooking needs. These burners are located at the left front and left rear and right rear positions on the cooktop.

The **POWER** burner is best used for bringing large quantities of liquid rapidly up to temperature or when preparing larger quantities of food. This burner is located at the right front position on the cooktop.

The **BRIDGE** burner is best suited when using rectangular or long shaped cookware. The left rear and left middle are combined and controlled by the same control knob. The left front burner may also be added for a total of 3 burners.

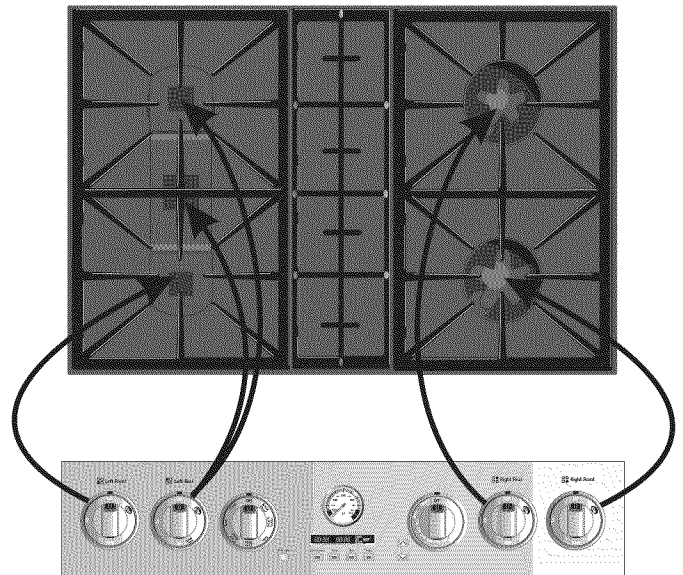

Figure 4

Setting Surface Controls

CAUTION Do not place plastic items such as salt and pepper shakers, spoon holders or plastic wrappings on top of the range when it is in use.

These items could melt or ignite. Potholders, towels or wood spoons could catch fire if placed too close to a flame.

In the event of an electrical power outage, the surface burners can be lit manually. To light a surface burner, hold a lit match to the burner head, then slowly turn the surface control knob to **LITE**. After burner lights push in and turn knob to desired setting. Use caution when lighting surface burners manually.

Operating the Gas Surface Controls:

1. Place cooking utensil on surface burner.
2. Push the surface control knob down and turn **counterclockwise** out of the OFF position (See Figure 1).
3. Release the knob and rotate to the LITE position. Note: All four electronic surface igniters will spark at the same time. However, only the burner you are turning on will ignite.
4. Visually check that the burner has a flame.
5. Turn the control knob **counterclockwise** to the desired flame size. The control knobs do not have to be set at a particular setting. Use the knob indicator settings to adjust the flame as needed. **DO NOT** cook with the surface control knob in the LITE position. (The electronic ignitor will continue to spark if the knob is left in the LITE position.)

Setting Proper Surface Burner Flame Size

For most cooking, start on the highest control setting and then turn to a lower one to complete the process. Use the recommendations below as a guide for determining proper flame size for various types of cooking. The size and type of utensil used and the amount of food being cooked will influence the setting needed for cooking.

*Flame Size	Type of Cooking
High Flame	Start most foods; bring water to a boil; pan broiling.
Medium Flame	Maintain a slow boil; thicken sauces, gravies; steaming.
Low Flame	Keep foods cooking; poach; stewing.

***These settings are based on using medium-weight metal or aluminum pans with lids. Settings may vary when using other types of pans.** The color of the flame is the key to proper burner adjustment. A good flame is clear, blue and hardly visible in a well-lighted room. Each cone of flame should be steady and sharp. Clean burner if flame is yellow-orange.

Regardless of size, always select cookware that is suitable for the amount and type of food being prepared. Select a burner and flame size appropriate to the pan. Never allow flames to extend beyond the outer edge of the pan.

Never extend the flame beyond the outer edge of the utensil. A higher flame wastes heat and energy and increases your risk of being burned by the flame (Figure 2).

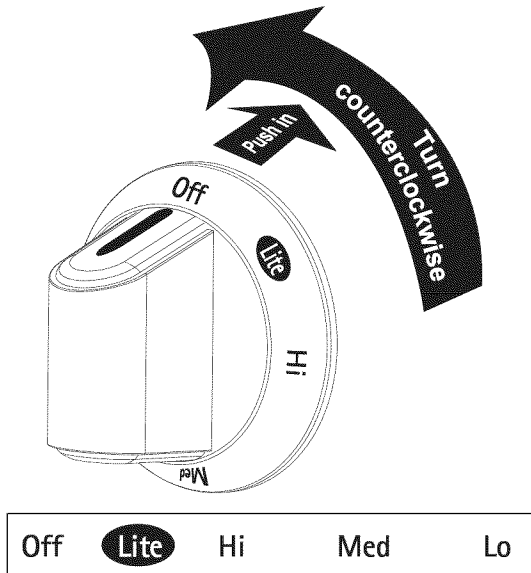

Figure 1

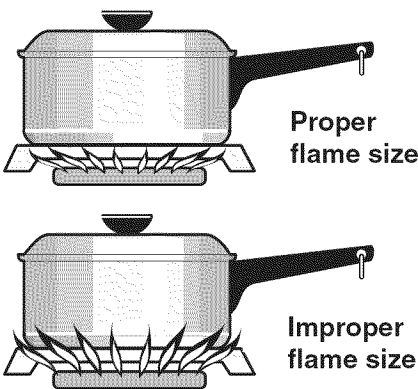

Figure 2

For deep fat frying, use a thermometer and adjust the surface control knob accordingly. If the fat is too cool, the food will absorb the fat and be greasy. If the fat is too hot, the food will brown quickly and the center will be undercooked. Do not attempt to deep fat fry too much food at once as the food will neither brown nor cook properly.

Setting Surface Controls (cont'd)

Setting the Bridge Burner

The Bridge Burner should be used with rectangular shaped cookware. Cookware like the cast-iron Griddle that is supplied with your cooktop is designed specifically for best results with the Bridge Burner.

The Bridge Burner feature may be used to combine the cooking power of 2 or if needed 3 gas surface Burners located along the left-hand side of the glass cooktop. The left rear and left center Burners are controlled by the left rear surface Control Knob. In addition the left front Burner may be added to the Bridge Burner with the left front gas Control Knob.

Operating the Bridge Burner

1. Push the left rear surface control knob in and turn **counterclockwise** out of the OFF position (See Figure 2).
2. Release the knob and rotate to the **LITE** position (See Figure 2 & 3).
Note: All electronic surface ignitors will spark at the same time. However, only the selected surface Burner will lite.
3. Visually check that the left rear Burner has lit.
4. Continue to rotate the gas control knob counterclockwise past the first LO setting to the arrow marked **Multi**. The left center burner will lite.
5. Visually check that both the left rear and left center Burners are lit. Adjust the flame size by turning the control knob between the **second HI and LO settings** (See Figure 3).
6. Add the left front Burner if needed. Once lit, visually adjust the flame size of the left front Burner to match the flame size of the Bridge Burner.
7. Place cooking utensil centered over the left-hand cooktop surface Burner Grate. **DO NOT** cook with any of the surface control knobs in the LITE position (The electronic ignitor will continue to spark if the knob is left in the LITE position).

Note: If only the left rear surface Burner is needed, follow the instructions provided below.

Operating only the Left Rear Burner

1. Place cooking utensil centered over the left-rear surface Burner Grate.
2. Push the left rear surface control knob in and turn **counterclockwise** out of the OFF position (See Figure 2).
3. Release the knob and rotate to the **LITE** position. Note: All electronic surface ignitors will spark at the same time. However, only the left rear Burner will ignite.
4. Visually check that the left-rear burner has lit. Adjust the flame size by turning the control knob between the **first HI and LO settings** (See Figure 3). **DO NOT** cook with the surface control knob in the LITE position (The electronic ignitor will continue to spark if the knob is left in the LITE position).

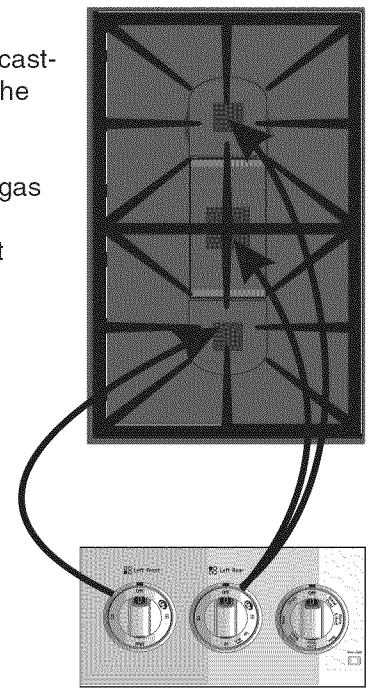

Figure 1

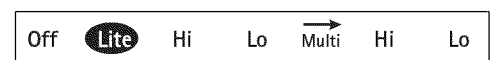
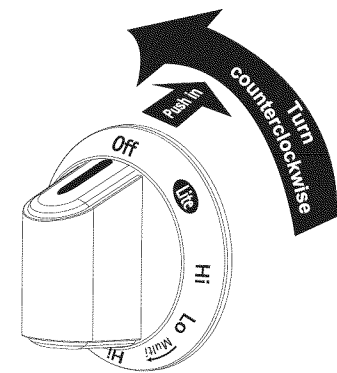

Figure 2

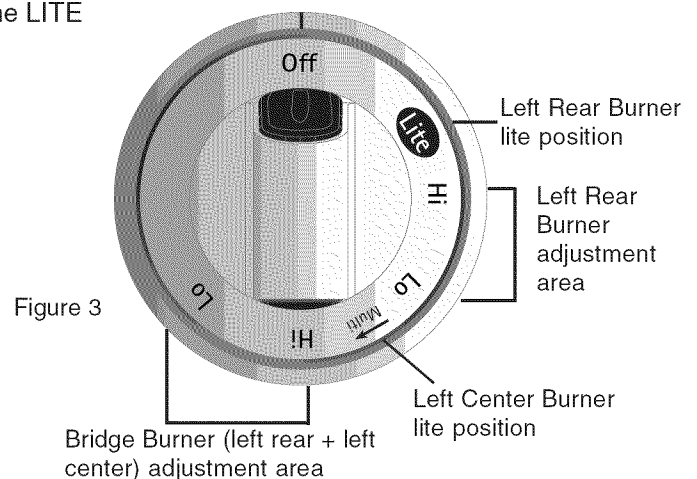

Figure 3

Surface Cooking Use Proper Cookware

Cookware should have flat bottoms that make good contact with the entire surface heating element. Check for flatness by rotating a ruler across the bottom of the cookware (See Figure 1). Be sure to follow the recommendations for using cookware as shown in Figure 2.

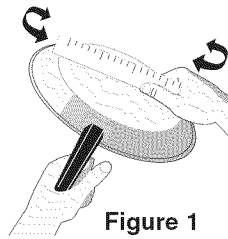
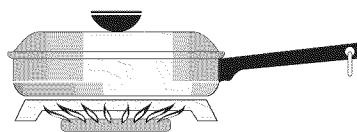

Figure 1

Note: The size and type of cookware used will influence the setting needed for best cooking results.

Note: Always use a utensil for its intended purpose. Follow manufacturer's instructions. Some utensils were not made to be used in the oven or on the cooktop.

CORRECT



- Flat bottom and straight sides.
- Tight fitting lids.
- Weight of handle does not tilt pan. Pan is well balanced.
- Pan sizes match the amount of food to be prepared.
- Made of material that conducts heat well.
- Easy to clean.

INCORRECT

- Curved and warped pan bottoms.

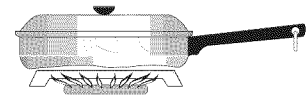

- Pan overhangs burner grate by more than 2.5 cm (1").

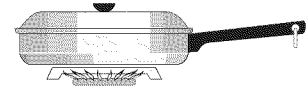

- Heavy handle tilts pan.

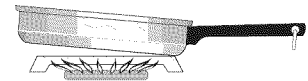

- Flame extends beyond pan.

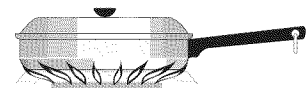
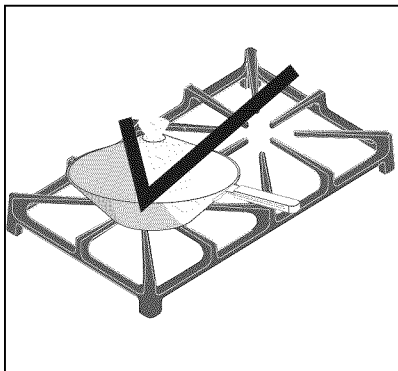

Figure 2

- * Specialty pans such as lobster pots, griddles and pressure cookers may be used but must conform to the above recommended cookware requirements.

Using a wok



Woks with flat bottoms suitable for use on your cooktop are available in most cookshop or hardware stores. Round-bottomed woks (with a support ring that does not extend beyond the burner circumference) may also be used. The metal ring was designed to support the wok safely when it is filled with large amounts of liquids (soup making) or fat (frying).

Wire trivets: Do not use wire trivets. Cookware bottoms must be in direct contact with the grates.

DO NOT use a wok if it is equipped with a metal ring that extends beyond the burner circumference. Because this ring traps heat, the surface unit and cooktop surface could be damaged.

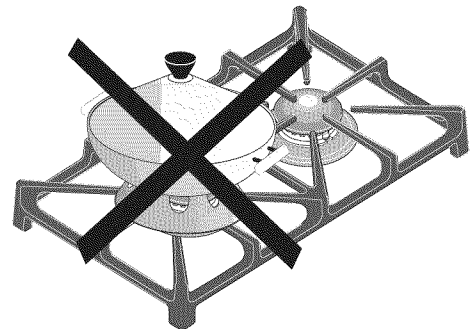

Using the simmer plate

The simmer plate is intended to diffuse lower temperature of the burner to help cooking delicate food items such as chocolate, milk, bechamel, etc. The simmer plate can also be used for cooking sauces during long period. With the grate in position over the burner, set the simmer plate on top of the grate, positioning the notches in the simmer plate over the grate fingers; then place the utensil on the simmer plate.

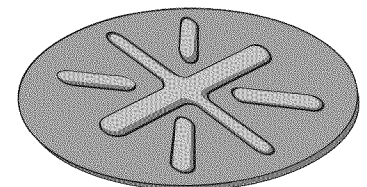

Simmer Plate

CAUTION Always place the simmer plate on the grate before turning on the burner.

CAUTION Always use potholders to remove the simmer plate from the grate. Allow the simmer plate to cool before removing. Do not set hot simmer plate on surfaces such as countertops that cannot withstand high heat.

CAUTION Be sure the simmer plate is positioned correctly and stable before use to prevent hot spills and possible burns.

Surface Cooking

Care & Seasoning of the Griddle

Before first use:

- Wash Griddle in hot soapy water. Rinse and then dry completely.
- Apply a thin coat of vegetable oil to the entire surface (front and back of griddle).
- Preheat your oven to 350°F. Place the griddle on the upper rack in your oven.
- Bake griddle for 1 hour at 350°F, then turn oven OFF and let cool before removing.
- The surface may appear to have a tacky feel to it from the seasoning process. If desired, wash the griddle in hot soapy water, rinse well, and dry completely.

After each use:

- To prevent rusting, store in a dry place and keep uncovered.
- After each use, clean with a stiff brush and hot water only.
- **DO NOT CLEAN GRIDDLE IN DISHWASHER.**
- Dry Immediately and apply a light coating of vegetable oil to griddle before storing.

Using the Griddle:

- Place either side of the griddle centered over the left side gas burners or over the Bridge Burner. For location refer to Figure 1.
- Preheat the griddle for 5 minutes on medium to medium low setting. Slow preheat ensures even heat distribution during the cooking process.
- **DO NOT** preheat the griddle on HI setting. Preheating on HI may warp the griddle and prevent even heat distribution.

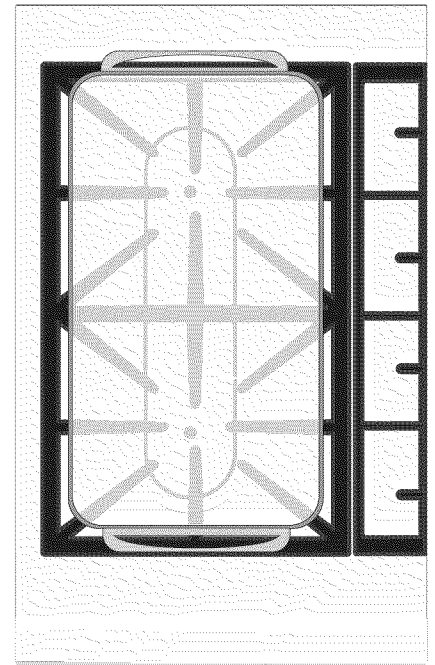

Figure 1

Before Setting Oven Controls

IMPORTANT: This range has a fan that will turn “ON” and “OFF” by itself to keep the electronics cool. It may continue to run after the range has been turned “OFF”, but may also stop immediately and then turn “ON” after a while.

Oven Vent Location

The oven vent is located **in the backsplash**. When the oven is on, hot air is released through the vents. This venting is necessary for proper air circulation in the oven and good baking results.

OVEN VENT

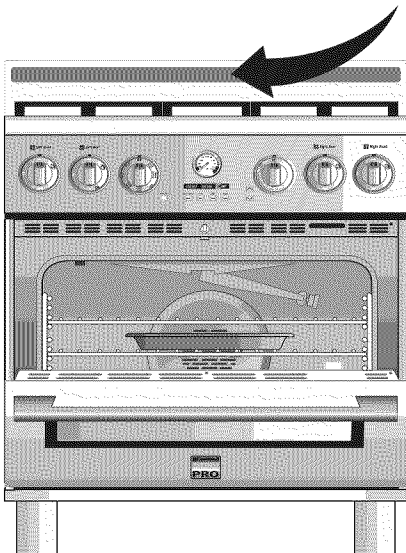

Removing and Replacing Oven Racks

To remove, pull the rack forward until it stops. Lift up front of rack and slide out. **To replace**, fit the rack onto the guides on the oven walls. Tilt the front of the rack upward and slide the rack back into place.

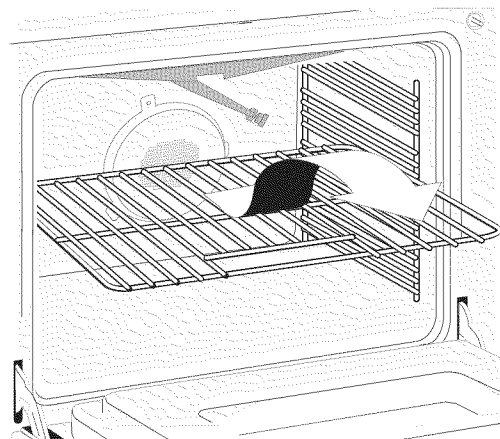

Before Setting Oven Controls (cont'd)

Arranging Oven Racks

ALWAYS ARRANGE OVEN RACKS WHEN THE OVEN IS COOL (PRIOR TO OPERATING THE OVEN). Always use oven mitts when the oven is hot.

CAUTION Always use pot holders or oven mitts when adjusting the oven racks. Wait until the oven has completely cooled if possible. Oven racks may be HOT and may cause burns.

Air Circulation in the Oven

For best air circulation and baking results allow 2-4" (5-10 cm) around the cookware for proper air circulation and be sure pans and cookware do not touch each other, the oven door, sides or back of the oven cavity. The hot air must circulate around the pans and cookware in the oven for even heat to reach around the food.

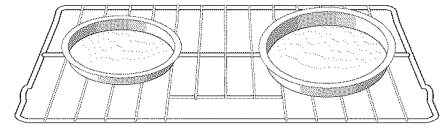

1 Oven Rack

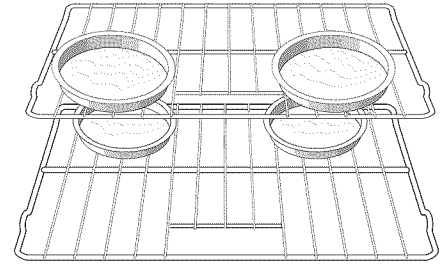

Multiple Oven Racks

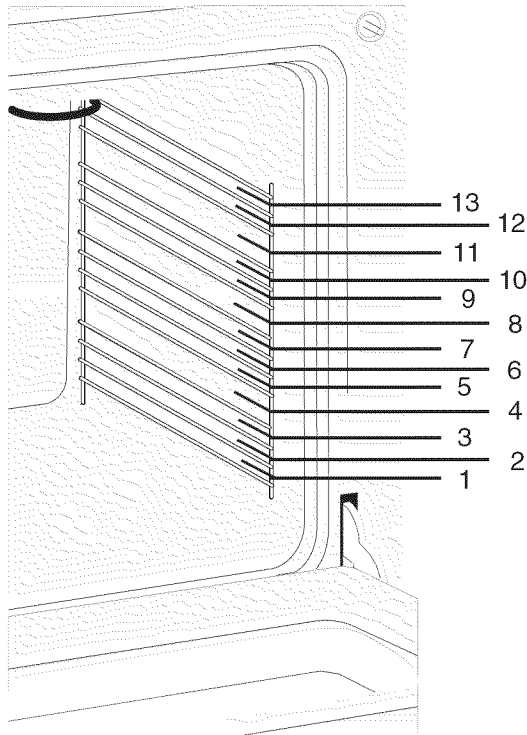

Ladder Rack Positions

Oven Ladder Racks

This appliance is equipped with an oven ladder rack system which allows oven racks to be placed in multiple positions. This system also facilitates the removal of oven racks and will give you more precise control of the desired baking results.

ONLY REMOVE LADDER RACKS WHEN THE OVEN IS COOL (PRIOR TO A SELF-CLEAN OPERATION). Always use oven mitts when the oven is in use.

To remove an oven ladder rack, pull the rack upward and remove it from the guides in the oven cavity.

To replace an oven ladder rack, fit the rack onto the guides of the oven cavity and push downward.

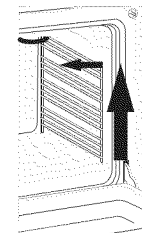

Ladder Rack Removal

Ladder Rack Replacement

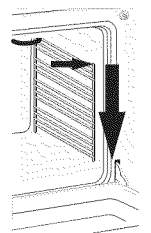

Control Button Features

READ THE INSTRUCTIONS CAREFULLY BEFORE USING THE OVEN. For satisfactory use of your oven, become familiar with the various features and functions of the oven as described below. **Detailed instructions for each feature and function follow later in this Use & Care Guide.**

SELECTOR CONTROL KNOB- Use to select the Bread Proof, Warm & Hold, Bake, Convection Bake, Convection Roast, Broil or Clean Feature.

OVEN TEMPERATURE CONTROL KNOB— Use to select the Bread Proof, Warm & Hold, or the required Bake, Convection Bake, Convection Roast, Broil or Clean Temperature.

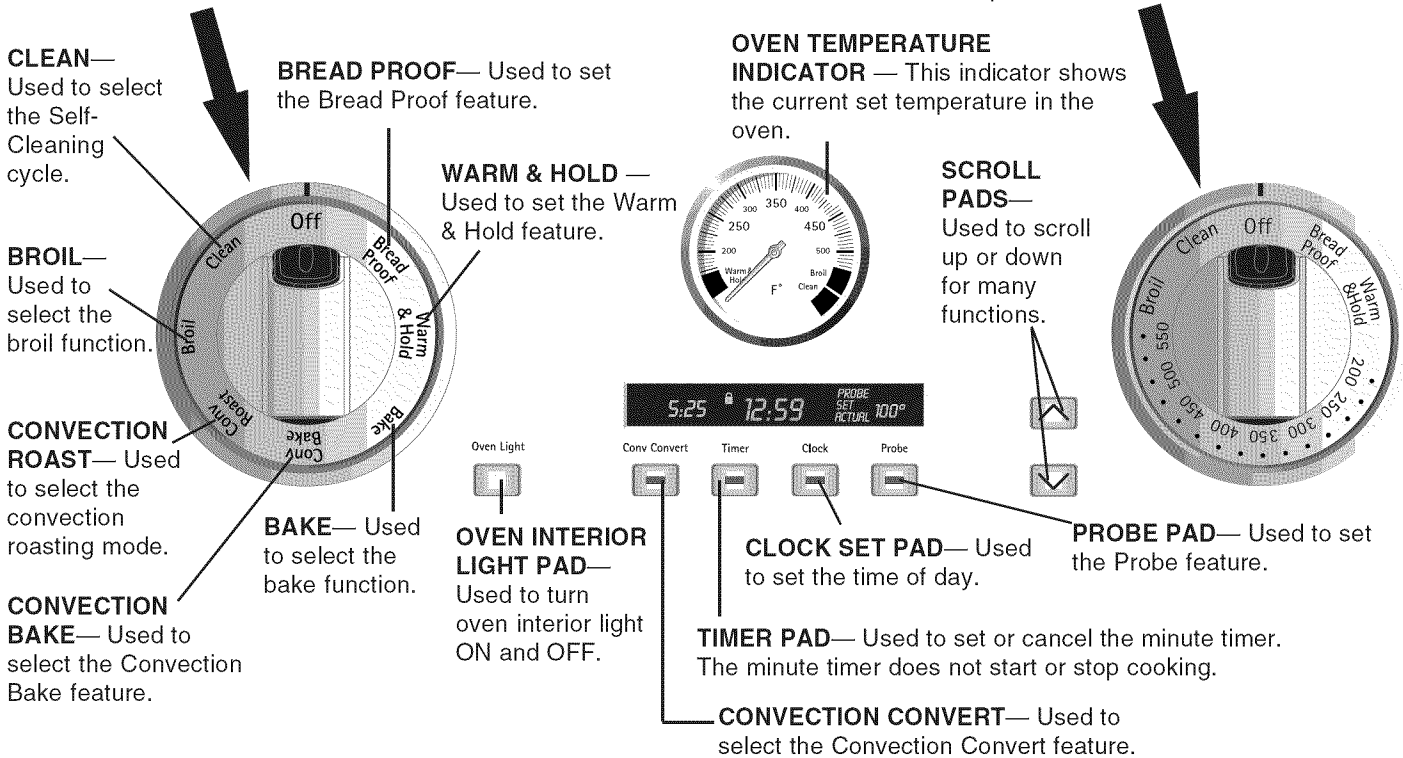





Setting the Clock



The  button is used to set the clock. Until the clock is set, all the other oven functions will not be available. The clock may be set for 12 or 24 hour time of day operation. The clock has been preset at the factory for the 12 hour operation. When the range is first plugged in, or when the power supply to the appliance has been interrupted, the display will flash with "PF" (Power Failure).

When PF flashes in the display, press the  button. No other button will stop the time from flashing.

To set the clock

1. Press the  button. The control will beep once and the time of day will appear in the display.
2. To set the clock to the current time of day, press the  or  button to increase or decrease the time of day in 1 minute increments, or keep the  or  button pressed to increase or decrease the time of day in 10 minute increments.
3. Release the button when the desired time is reached. Wait 5 seconds and the change will be accepted.

Changing between 12 or 24 hour time of day display



1. Press and hold the  button for 6 seconds. The display will show either "12" (for 12 hour clock) or "24" (for 24 hour clock).
2. Press the  or  button to switch between the 12 and 24 hour time of day display.
3. Wait 5 seconds to accept the change.

Setting the Clock (cont'd)

Setting Continuous Bake or 12 Hour Energy Saving

The oven control has a factory preset built-in 12 Hour Energy Saving feature that will shut off the oven if the oven control is left on for more than 11 hours and 59 minutes. The oven can be programmed to override this feature for Continuous Baking.







To set the control for Continuous Bake or 12 Hour Energy Saving features

1. Press and hold the  button for 6 seconds. The display will show either "12h" (for 12 hour maximum cooking time) or "--h" (for continuous cooking).
2. Press the  or  button to switch between the 12 hour and 24 hours continuous cooking mode.
3. Wait 6 seconds for the controls to accept the change.

Setting the Timer

The Timer serves as an extra timer in the kitchen that will beep when the set time has run out. It can be set in 1 minute increments up to 11:59 (11 hours, 59 minutes). It does not start or stop cooking. The Kitchen Timer feature can be used during any of the other oven control functions, except the self-clean function.

To set the Kitchen Timer

1. Press the  button. The control will beep, the display will show "--:--" and the timer indicator light located on the button will start flashing.
2. To set the timer, press the  or  button to increase or decrease the time in 1 minute increments, or keep the  or  button pressed to increase or decrease the time in 10 minute increments.
3. When the set time has run out, "End" will show in the display. The control will sound with 3 beeps every 5 seconds until the  button is pressed.



To cancel the Kitchen Timer before the set time has run out

Press the  button. The display will return to the time of day.



Setting Oven Lockout Feature

The Oven Lockout feature automatically locks the oven door and prevents the Oven from being turned on. It does not disable the clock, Kitchen Timer or the interior oven lights.

To activate the Oven Lockout feature

1. Press and hold the  for 3 seconds.
2. Allow 20 seconds for the door to lock. The  icon will flash while the door is locking and will stay on once the door is locked.

To deactivate the Oven Lockout feature:

1. Press and hold the  for 3 seconds.
2. After 3 seconds  icon will disappear in the display. Allow 20 seconds for the door to unlock. The  icon will flash while the door is unlocking.

Setting Oven Controls

Setting Bake

The oven can be set to bake at any temperature from 170° F to 550° F (The sample shown is for 350°F).

Note that the convection fan will operate while the oven pre-heats.

To set the Bake Temperature to 350°F

1. Arrange interior oven racks, place food in oven and close oven door.
2. Turn the selector control knob to Bake (Figure 1).
3. Turn the temperature control knob to 350 (Figure 2).

The temperature will appear briefly in the oven control display.

The display will beep indicating that the temperature is set. Then the temperature will disappear from the display.

4. When baking is completed, turn the temperature and the selector control knobs to Off position.

NOTE : The temperature knob can be used to modify the baking temperature while the oven is in bake mode, but the function knob **cannot** be changed to another function without turning it to Off first. An **ERR** code will appear in the display if another function is selected without turning to Off.

NOTE : The control will beep three times if the mode and temperature **do not** match. The control will beep only once if the mode and temperature **do** match.

Example: Bread Proof with temperature at 500° F (not possible, 3 beeps).

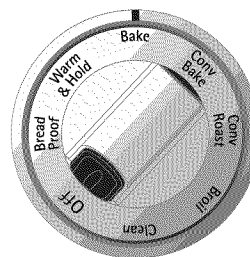

Figure 1

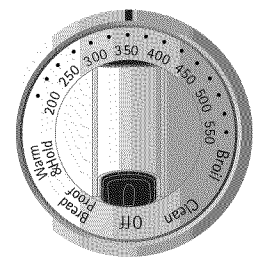

Figure 2

Setting Oven Controls (cont'd)

Oven Baking

For best cooking results, pre-heat the oven before baking cookies, breads, cakes, pies or pastries, etc.

The cooking times and temperatures needed to bake a product may vary slightly from your previously owned appliance. If you feel your oven is too hot or too cold, you can adjust its temperature. Refer to the "Adjusting Oven Temperature" section.

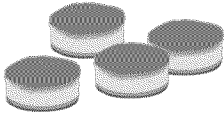
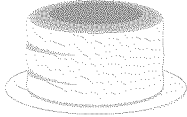
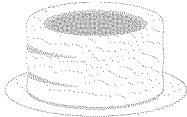
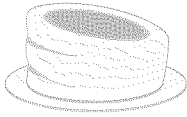
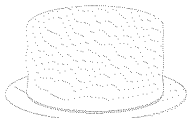
Baking Problems and Solutions Chart		
Baking Problems	Causes	Corrections
<p>Cookies and biscuits burn on the bottom.</p> 	<ul style="list-style-type: none"> • Cookies and biscuits put into the oven before the preheating time is completed. • Oven rack overcrowded. • Dark pan absorbs heat too fast. 	<ul style="list-style-type: none"> • Allow oven to preheat to the selected temperature before placing food in oven. • Choose pan sizes that will permit 2" to 4" (5.1 cm to 10.2 cm) of air space on all sides when placed in the oven. • Use a medium-weight aluminum baking sheet.
<p>Cakes too dark on top or bottom.</p> 	<ul style="list-style-type: none"> • Cakes put into the oven before preheating time is completed. • Rack position too high or low. • Oven too hot. 	<ul style="list-style-type: none"> • Allow oven to preheat to the selected temperature before placing food in the oven. • Use proper rack position for baking needs. • Set oven temperature 25°F lower than recommended.
<p>Cakes not done in the center.</p> 	<ul style="list-style-type: none"> • Oven too hot. • Incorrect pan size. • Pan not centered in oven. 	<ul style="list-style-type: none"> • Set oven temperature 25°F lower than recommended. • Use pan size suggested in recipe. • Use proper rack position and place pan so there is 2" to 4" (5.1 cm to 10.2 cm) of space on all sides of pan.
<p>Cakes not level.</p> 	<ul style="list-style-type: none"> • Range not level. • Pan too close to oven wall or rack overcrowded. • Pan warped. 	<ul style="list-style-type: none"> • Place a marked glass measuring cup filled with water on the center of the oven rack. If the water level is uneven, refer to the installation instructions for leveling the appliance. • Be sure to allow 2" to 4" (5.1 cm to 10.2 cm) of clearance on all sides of each pan in the oven. • Do not use pans that are dented or warped.
<p>Foods not done when cooking time is up.</p> 	<ul style="list-style-type: none"> • Oven too cool. • Oven overcrowded. • Oven door opened too frequently. 	<ul style="list-style-type: none"> • Set oven temperature 25°F higher than suggested and bake for the recommended time. • Be sure to remove all pans from the oven except the ones to be used for baking. • Open oven door only after shortest recommended baking time.

Setting Oven Controls (cont'd)

Setting Convection Bake

Use the Convection Bake feature when fast cooking is desired. The oven can be programmed for Convection baking at any temperature between 300°F and 550°F. Convection baking uses a fan to circulate the oven's heat evenly and continuously within the oven (See Figure 1). This improved heat distribution allows even cooking and browning results at a lower temperature than conventional bake. It also gives better baking results when using 2 or 3 racks at the same time. Breads and pastries brown more evenly. For baking efficiency, the fan rotates slower in Convection Bake than in Convection Roast. Note: Allow 6 minutes for the convection fan to start rotating.

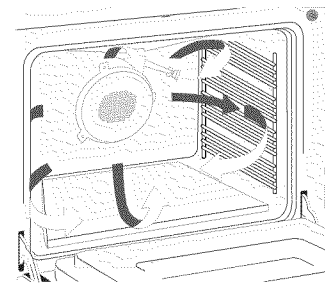

Air circulation during Convection Bake

Figure 1

General Convection Bake Instructions

1. Adjust the cook time for desired doneness as needed. Cookies and biscuits should be baked on pans with no sides or very low sides to allow heated air to circulate around the food. Food baked on pans with a dark finish will cook faster.
2. Preheating is not necessary when cooking casseroles with Convection Bake.
3. When using Convection Bake with a single rack, place oven rack in position 8. If cooking on multiple racks, place the oven racks in positions 6 and 11 (see page 13).

Benefits of Convection Bake:

- Multiple rack baking.
- No special pans or bakeware needed.

To set the oven to Convection Bake at 350°F

1. Arrange interior oven racks, place food in oven and close oven door.
2. Turn the selector control knob to Conv Bake (Figure 2).
3. Turn the temperature control knob to 350 (Figure 3).
The temperature will appear briefly in the oven control display. The display will beep indicating that the temperature is set. Then the temperature will disappear from the display.
4. When baking is completed, turn the temperature and the selector control knobs to Off position.

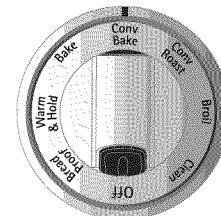

Figure 2

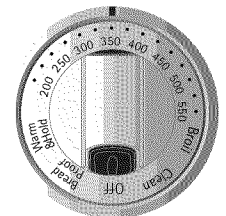

Figure 3

Setting Convection Roast

This method of cooking enables you to obtain the best results when roasting. Allow your oven to preheat before roasting. A beep will let you know when the convection roast temperature is reached. The oven can be programmed to convection roast at any temperature from 300°F to 550°F. Remember to use tested recipes with times adjusted for convection roasting when using the convection mode. For roasting efficiency, the fan rotates faster in Convection Roast than in Convection Bake. Note: Allow 6 minutes for the convection fan to start rotating.

To Set the oven to Convection Roast at 350°F

1. Arrange interior oven racks, place food in oven and close oven door.
2. Turn the selector control knob to Conv Roast (Figure 4).
3. Turn the temperature control knob to 350 (Figure 5). The temperature will appear briefly in the oven control display. The display will beep indicating that the temperature is set. Then the temperature will disappear from the display.
4. When baking is completed, turn the temperature and the selector control knobs to Off position.

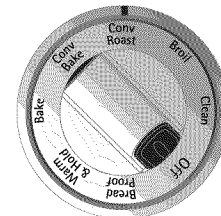

Figure 4

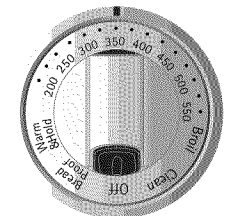



Figure 5

Setting Convection Convert

The appliance is equipped with a feature which will allow you to change from a normal baking recipe temperature to a convection baking temperature without making any manual temperature adjustment; the controller will do it automatically.

The  pad controls the convection convert feature.

To change from a normal bake recipe to a convection bake recipe

When the convection bake mode is on, press . This function will lower the oven temperature by 25°F less than the control setting. When convection baking is completed turn the temperature and the selector control knobs to Off position.

Note: The oven temperature indicator will show a temperature 25°F lower than temperature control knob setting.

ENGLISH

Setting Oven Controls (cont'd)

Using the Temperature Probe Feature

For many foods, especially roasts and poultry, testing the internal temperature is the best method to insure properly cooked food. The Temperature Probe gets the exact temperature you desire without having to guess.

IMPORTANT:

1. Use only the probe supplied with your appliance; any other may result in damage to the probe or the appliance.
2. Handle the Temperature Probe carefully when inserting and removing it from the food and outlet.
3. Do not use tongs to pull the cable when inserting or removing the Probe. It could damage the Probe.
4. Defrost your food completely before inserting the Probe to avoid breaking it.
5. Never leave or store the Temperature Probe inside the oven when not in use.
6. To prevent the possibility of burns, carefully unplug the Temperature Probe using hot pads.

Proper Temperature Probe Placement:

1. Always insert the probe so that the tip rests in the center of the thickest part of the meat. Do not allow probe to touch bone, fat, gristle or pan.
2. For bone-in ham or lamb, insert the Probe into the center of the lowest large muscle or joint. For dishes such as meat loaf or casseroles, insert the Probe into the center of the food. When cooking fish, insert the Probe from just above the gill into the meatiest area, parallel to the backbone.
3. For whole poultry (chicken, turkey, etc.), insert the probe into the thickest part of the inner thigh from below and parallel to the leg (see figure 1).

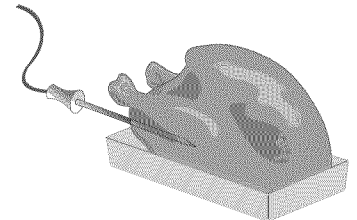





Figure 1

Setting the Oven When using the Temperature Probe:

1. Preheat the oven to the desired temperature.
2. Insert the Temperature Probe into the food (see Proper Temperature Probe Placement above).
3. After the oven has reached the desired temperature, place the food into the oven.
4. The oven will be hot, so wear an oven mitt and plug the Temperature Probe into its outlet in the oven. (The outlet is located on the left front side of the oven cavity ceiling). Make sure it is pushed all the way into the outlet. Close the oven door.
5. The oven control will detect if the probe is correctly plugged in and will illuminate PROBE in the display. The display will start showing the actual meat temperature shortly after the probe is inserted.
6. A target temperature must be set to trigger the buzzer when the food is done cooking. Press the  button to enter the temperature. Adjust temperature to the desired setting using the  or  buttons. The temperature setting will be accepted 5-8 seconds after it is entered.
7. At any time during the cooking, the  button can be pressed to change the display between "ACTUAL" and "PROBE". The "ACTUAL" setting will give you the current temperature of the food. The "PROBE" setting will give you the food target temperature and it can be changed at any time during the cooking (see above for explanations).

IMPORTANT: The probe can be damaged by very high temperature. To protect the probe against this damage, the oven control will not allow you to start a self-clean or a broil while the probe is connected.

Setting the Bread Proof Feature

To enable the Bread Proof function, both controls need to be turned to the Bread Proof option, as illustrated below.

Preparing Bread Dough In The Oven

The oven has a Bread Proof feature that can be used to help prepare bread dough. The recommended length of time to keep bread dough in the oven is about 45-60 minutes. Be sure however to follow the recipe's recommended times. The prepared bread dough should be placed in a large bowl since the dough will nearly double in volume. Arrange the oven rack in the lowest position. Place the bowl on the rack in the oven and follow the Bread Proof Control setting instructions as illustrated.

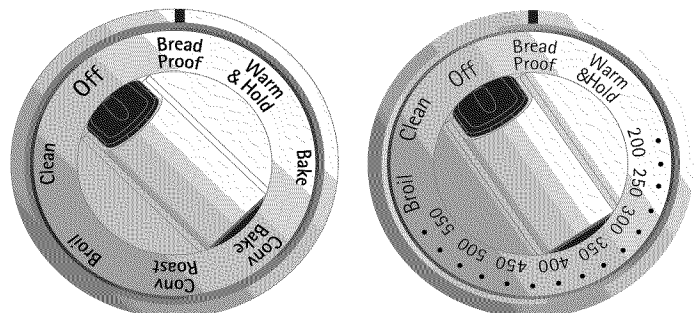

Setting Oven Controls (cont'd)

Setting the Warm & Hold™ Feature

The **Warm & Hold** feature will maintain an oven temperature of 170°F, and will keep oven baked foods warm for serving for 3 hours after cooking has finished. The Warm & Hold feature may be used without any other cooking operations or can be used after cooking has finished.

To set Warm & Hold

1. Arrange interior oven racks and place food in oven.
2. Turn both the selector and the temperature control knobs to Warm Hold position.
3. To turn the Warm & Hold OFF at any time, turn the temperature and the selector control knobs to Off position.

Setting Broil

When broiling, heat radiates downward from the oven broiler for even coverage. The Broil feature is preset to start broiling at 550°F; however, the Broil feature temperature may be set between 400°F and 550°F. This appliance includes a Searing Grill for searing meats (Figure 3). The broil pan and broil pan insert used together allow dripping grease to drain and be kept away from the high heat of the oven broiler. **DO NOT** use the broil pan without the insert (See Figure 1). **DO NOT cover the broil pan insert with foil.** The exposed grease could catch fire.

⚠ WARNING Should an oven fire occur, leave the oven door closed and turn off the oven. If the fire continues, throw baking soda on the fire or use a fire extinguisher. **DO NOT** put water or flour on the fire. Flour may be explosive and water can cause a grease fire to spread and cause personal injury.

To set the oven to broil

1. Place the broiler pan insert on the broiler pan (Figure 1). Then place the food on the broiler pan insert. **DO NOT** use the broiler pan without the insert. **DO NOT** cover the broiler insert with foil. The exposed grease could ignite.
2. Arrange the interior oven rack.
3. Turn both the selector and the temperature control knobs to the Broil position.
4. Preheat oven 2 to 5 minutes.
5. Place the broiler pan on the rack. Be sure to center the broiler pan directly under the broiler element. **Make sure the oven door is in the broil stop position (See Figure 2).**
6. If a lower broil temperature is desired (minimum allowed broil temperature is 400°F), turn the temperature control knob to the temperature desired.
7. Broil on one side until food is browned; turn and cook on the second side. Season and serve. **Note:** Always pull the rack out to the stop position before turning or removing food.
8. To cancel broiling or if finished broiling, turn the selector and the temperature control knobs to Off position.

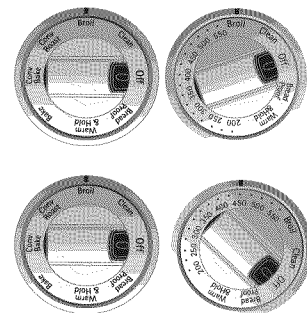

ENGLISH

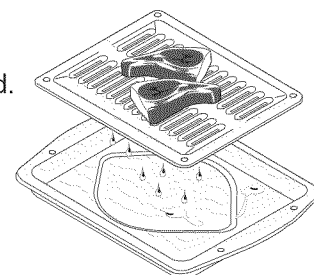
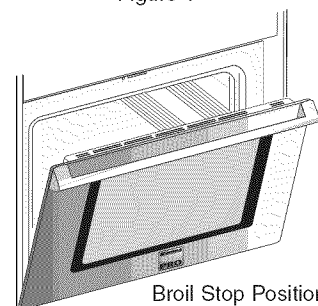
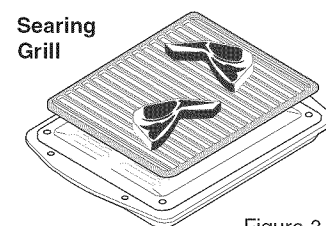

Figure 1



Broil Stop Position
Figure 2



Broil Pan & insert
Figure 3

Broiling Times and Searing Grill

Use the following table for approximate broiling times. Increase or decrease broiling times, or move the broiling pan to a different rack position to suit for doneness. If the food you are broiling is not listed in the table, follow the instructions provided in your cookbook and watch the item closely. Use the Searing Grill for meats and steaks if desired. Place Searing Grill on top of Broiler Pan and Insert before placing the meat. Be sure to pre-heat the Searing Grill using Broil for 10 minutes. Cook times should be reduced 1-2 minutes per side when cooking with the Searing Grill for meats and steaks (See Figure 3).

IMPORTANT: When in broiling mode, a very audible high speed cooling fan will turn on and may continue for some minutes after broiling is finished.

Electric Range Broiling Table Recommendations

Food Item	Rack Position	Temp Setting	Cook Time		Doneness
			1st side	2nd side	
Steak 1" thick	12	550° F	6:00	4:00	Rare
	12	550° F	7:00	5:00	Medium
Pork Chops 3/4" thick	12	550° F	8:00	6:00	Well
Chicken - Bone In	11	450° F	20:00	10:00	Well
Chicken - Boneless	12	450° F	8:00	6:00	Well
Fish	12	500° F	13:00	n/a	Well
Shrimp	11	550° F	5:00	n/a	Well
Hamburger 1" thick	12	550° F	9:00	7:00	Medium
	11	550° F	10:00	8:00	Well

Self-Cleaning

CAUTION During the self-cleaning cycle, the outside of the wall oven can become very hot to the touch. **DO NOT** leave small children unattended near the appliance.

CAUTION The health of some birds is extremely sensitive to the fumes given off during the self-clean cycle of any wall oven. Move birds to another well ventilated room.

CAUTION DO NOT line the oven walls, racks, bottom or any other part of the appliance with aluminum foil. Doing so will destroy heat distribution, produce poor baking results and cause permanent damage to the interior (aluminum foil will melt to the interior surface of the oven).

CAUTION DO NOT force the oven door open. This can damage the automatic door locking system. Use caution when opening the door after the Self-Cleaning cycle is completed. The oven may still be **VERY HOT**.



Note: See additional cleaning information for the oven door in the **General Care & Cleaning** section.

Self-Cleaning Oven

A Self-Cleaning oven cleans itself with high temperatures (well above cooking temperatures) which eliminate soils completely or reduces them to a fine powdered ash you can wipe away with a damp cloth.

Adhere to the following cleaning precautions:

- Allow the oven to cool before cleaning.
- Wear rubber gloves when cleaning any exterior parts of the oven manually.
- **DO NOT** clean the oven door gasket. The woven material of the oven door gasket is essential for a good seal. Care should be taken not to rub, damage or remove the gasket.
- **DO NOT** use any cleaning materials on the oven door gasket. Doing so could cause damage.
- **Remove the ladder racks, oven racks and meat probe during self-cleaning. These items will be permanently damaged by the high cleaning temperatures.** If the racks are not removed, the self-clean cycle will cause them to discolor and make them difficult to slide. If this occurs, coat the racks with cooking oil to make them easier to slide again.
- **Remove any excessive spillovers** in the oven cavity **before** starting the Self-Cleaning cycle. To clean, use hot, soapy water and a cloth. Large spillovers can cause heavy smoke or fire when subjected to high temperatures. **DO NOT** allow food spills with a high sugar or acid content (such as milk, tomatoes, sauerkraut, fruit juices or pie filling) to remain on the surface as they may leave a dull spot even after cleaning.
- Clean any soil from the oven frame, the door liner outside the oven door gasket and the small area at the front center of the oven bottom. These areas do not heat sufficiently to burn soil on. Clean with soap and water.

NOTE: Prior to setting the Self-Clean cycle, any spills remaining on the oven bottom should be removed.

CAUTION The oven broil element may appear to have cooled after it has been turned OFF. **The element may still be hot** and burns may occur if this element is touched before it has cooled sufficiently.

What to Expect during Cleaning

While the oven is in operation, the oven heats to temperatures much higher than those used in normal cooking. Sounds of metal expansion and contraction are normal. Odor is also normal as the food soil is being removed. Smoke may appear through the oven vent.

If heavy spillovers are not wiped up before cleaning, they may flame and cause more smoke and odor than usual. This is normal and safe and should not cause alarm. If available, use an exhaust fan during the self-cleaning cycle.

Self-Cleaning (cont'd)

Self-Clean Cycle Time Length

If you are planning to use the oven directly after a self-clean cycle remember to allow time for the oven to cool down and the oven door to unlock. This normally takes about 1½ hour. So a self-clean cycle (3 hours) will actually take about 4½ hours to complete. The time remaining for the self-clean cycle will be displayed in the oven control display.

To set the controls for a Self-Cleaning cycle

1. Be sure the oven door is closed.
2. Turn both, the selector and the temperature control knobs to Clean position.
3. As soon as the control is set, the motor driven oven door lock will begin to close automatically. While the door is locking, the  icon will flash and then will remain visible for the entire self-clean cycle.

Note: Allow about 15 seconds for the oven door lock to close.

When the Self-Clean Cycle is Completed

1. Turn the selector and the temperature control knobs back to Off position.
2. Once the oven has cooled down for approximately 1½ HOUR, the oven door can then be opened. While the door is unlocking, the  icon will flash and then will disappear from the oven control display.

Stopping or Interrupting a Self-Cleaning Cycle



If it becomes necessary to stop or interrupt a self-cleaning cycle due to excessive smoke or fire in the oven:

1. Turn the selector and the temperature control knobs to Off position.
2. The oven door can only be opened after the oven has cooled down for approximately 1½ HOUR.

Adjusting Oven Temperature

The temperature calibration in the oven has been pre-set at the factory. When first using the oven, be sure to follow recipe times and temperatures. If you think the oven is cooking too hot or too cool for the temperature you select, you can adjust the actual oven temperature to be more or less than what is displayed. Before adjusting, test a recipe by using a temperature setting that is higher or lower than the recommended temperature. The baking results should help you to decide how much of an adjustment is needed.

To adjust the oven temperature

1. Press and hold the  button until "00" appears in the oven control display
2. To increase the temperature use the  button to enter the desired change; and to decrease the temperature use the  button (a minus sign will appear in the display indicating the temperature is decreased).
3. Wait 5 seconds for the change to be accepted by the oven control.

Note: The oven temperature adjustments made with this feature will not change the Self-Clean or Broil temperature. Once the temperature has been changed, the temperature indicator will still display the value set from the temperature knob but the actual temperature in the oven will be higher or lower.

⚠ CAUTION To avoid possible burns use care when opening the oven door after the Self-Cleaning cycle. Stand to the side of the oven when opening the door to allow hot air or steam to escape.

⚠ CAUTION DO NOT force the oven door open. This can damage the automatic door locking system. Use caution and avoid possible burns when opening the door after the Self-Cleaning cycle has completed. The oven may still be VERY HOT.

General Care & Cleaning

Cleaning Various Parts of Your Oven

Before cleaning any part of the oven, be sure all controls are turned OFF and the oven is COOL. REMOVE SPILLOVERS AND HEAVY SOILING AS SOON AS POSSIBLE. REGULAR CLEANINGS NOW WILL REDUCE THE EXTENT AND DIFFICULTY OF MAJOR CLEANING LATER.

Surfaces	How to Clean
Aluminum (Trim Pieces) & Vinyl	Use hot, soapy water and a cloth. Dry with a clean cloth. Do not scour or use all-purpose cleaners, ammonia, powdered cleaners or commercial oven cleaner. They can scratch and discolor aluminum.
Painted and Plastic, Control Panel, Body Parts, and Decorative Trim	<p>For general cleaning, use hot, soapy water and a cloth. For more difficult soils and built-up grease, apply a liquid detergent directly onto the soil. Leave on soil for 30 to 60 minutes. Rinse with a damp cloth and dry. DO NOT use abrasive cleaners on any of these materials; they can scratch.</p> <p>To remove control knobs, turn to the OFF position; grasp firmly and pull straight off the shaft. To replace knobs after cleaning, line up the flat sides of both the knob and the shaft; then push the knob into place.</p>
Stainless Steel, Chrome, Control Panel, Decorative Trim	<p>Before cleaning the control panel, turn all controls to OFF and remove the control knobs. To remove, pull each knob straight off the shaft. Clean using hot, soapy water and a dishcloth. Rinse with a clean water using a dishcloth. Be sure to squeeze excess water from the cloth before wiping the panel; especially when wiping around the controls. Excess water in or around the controls may cause damage to the appliance. To replace knobs after cleaning, line up the flat sides of both the knob and the shaft; then push the knob into place.</p> <p>Clean stainless steel with hot, soapy water and a dishcloth. Rinse with clean water and a cloth. Do not use cleaners with high concentrations of chlorides or chlorines. Always clean on the same direction as the stainless steel grain. Do not use harsh scrubbing cleaners. Only use kitchen cleaners that are especially made for cleaning stainless steel. Always be sure to rinse the cleaners from the surface as bluish stains may occur during heating that cannot be removed.</p>
Porcelain Enamel, Broiler Pan and Insert, Door Liner, Body Parts	Gentle scouring with a soapy scouring pad will remove most spots. Rinse with a 1:1 solution of clear water and ammonia. <i>If necessary</i> , cover difficult spots with an ammonia-soaked paper towel for 30 to 40 minutes. Rinse with clean water and a damp cloth, and then scrub with a soap-filled scouring pad. Rinse and wipe dry with a clean cloth. Remove all cleaners or the porcelain may become damaged during future heating. DO NOT use spray oven cleaners on the cooktop.

Oven Racks

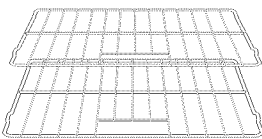

CAUTION Remove the ladder racks, oven racks and meat probe during self-cleaning. These items will be permanently damaged by the high cleaning temperatures. If the racks are not removed, the self-clean cycle will cause them to discolor and make them difficult to slide. If this occurs, coat the racks with cooking oil to make them easier to slide again.

Oven Door



Use soap & water to thoroughly clean the top, sides and front of the oven door. Rinse well. You may use a glass cleaner on the outside glass of the oven door. **DO NOT** immerse the door in water. **DO NOT spray or allow water or the glass cleaner to enter the door vents.** **DO NOT** use oven cleaners, cleaning powders or any harsh abrasive cleaning materials on the outside of the oven door.

DO NOT clean the oven door gasket. The oven door gasket is made of a woven material, which is essential for a good seal. Care should be taken not to rub, damage or remove this gasket.

General Care & Cleaning (cont'd)

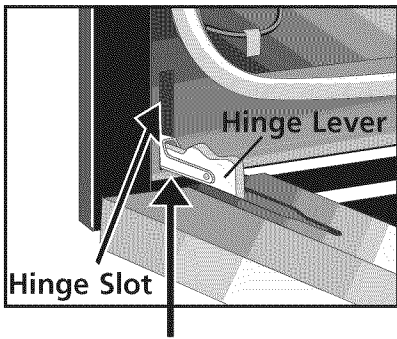

Lock in normal position
Figure 1

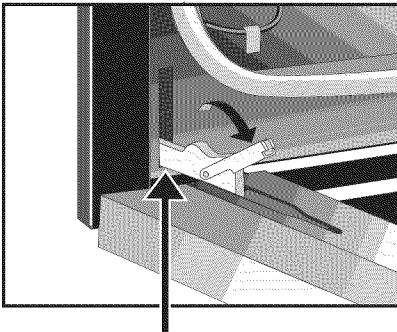

Lock engaged for door removal
Figure 2

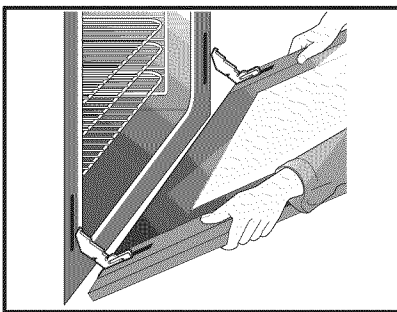

Door removed from the oven
Figure 3

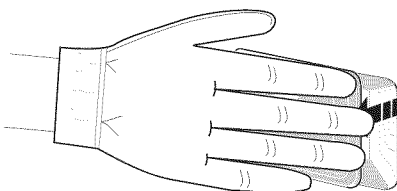

Lift up and pull out.

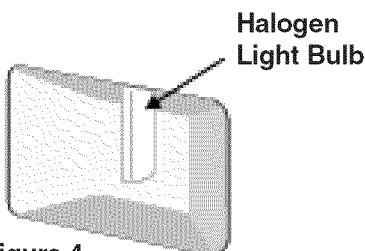

Figure 4

Care and Cleaning of Stainless Steel

This model is equipped with stainless steel exterior parts. Special care and cleaning are **required** for maintaining the appearance of stainless parts. Please refer to the table provided at the beginning of the **General Care & Cleaning** section in this Use & Care Guide.

Removing and Replacing the Oven Door

⚠ CAUTION The door is heavy. For safe, temporary storage, lay the door flat with the inside of the door facing down.

To Remove Oven Door:

1. Open the door to the fully opened position.
2. Pull up the lock located on both hinge levers to door removal position (Figure 2).
3. Grab the door by the sides and pull the bottom of the door up and toward you to disengage the hinge levers from the hinge slots. Keep pulling the bottom of the door toward you while rotating the top of the door toward the range to completely disengage the hinge levers (Figure 3).
4. To clean oven door, follow the instructions provided in the **General Care & Cleaning** table.

To Replace Oven Door:

1. Grab the door by the sides by holding as close to the hinge as possible.
2. Carefully place the hinge levers into the hinge slots by taking care not to chip the porcelain.
3. Open the door to the fully opened position.
4. Engage the lock on both hinge levers to normal position (Figure 1).
Note: Make sure the hinge levers are fully inserted into hinge slots before locking them.
5. Close the oven door.

Special Door Care Instructions

Oven doors contain glass that can break.

Read the following recommendations:

1. Do not close the oven door until all the oven racks are fully in place.
2. Do not hit the glass with pots, pans, or any other object.
3. Scratching, hitting, jarring or stressing the glass may weaken its structure causing an increased risk of breakage at a later time.

Changing the Oven Light

The oven lights will automatically turn ON when the oven door is opened. The oven lights may also be manually operated by pressing the  pad.

The oven light bulb is covered with a glass shield. The glass shield can be removed to be cleaned manually or to change oven light. **THIS GLASS SHIELD MUST BE IN PLACE WHENEVER THE OVEN IS IN USE.**

To replace the light bulb:

CAUTION: BE SURE THE OVEN IS COOL.

1. Turn the power off at the main source.
2. Wear a leather-faced glove for protection against possible broken glass.
3. To remove the glass shield, lift up on side with gloved finger and use force to pull shield out.
4. Replace halogen light appliance bulb taking care not to touch the bulb with your bare fingers. Touching bulb with your skin can leave a film on the bulb that causes it to burn out quickly.
5. Replace glass shield in opposite order and manner of removal.

General Care & Cleaning (cont'd)

Cleaning the Cooktop, Burner Heads, Caps & Grates

The cooktop is designed to make cleaning easier. Because the gas Burners are sealed, cleanups are easy when spillovers are cleaned up immediately.

The cooktop, Burner Heads and Caps should be routinely cleaned. Keeping the Burner Head Ports clean will prevent improper ignition and an uneven flame. Refer to the following instructions:

THE COOKTOP IS NOT REMOVABLE. Do not attempt to remove or lift the cooktop.

⚠ CAUTION Use caution when replacing the Burner Caps so the Electrodes are not damaged. This may cause a delayed ignition or prevent the burner from igniting.

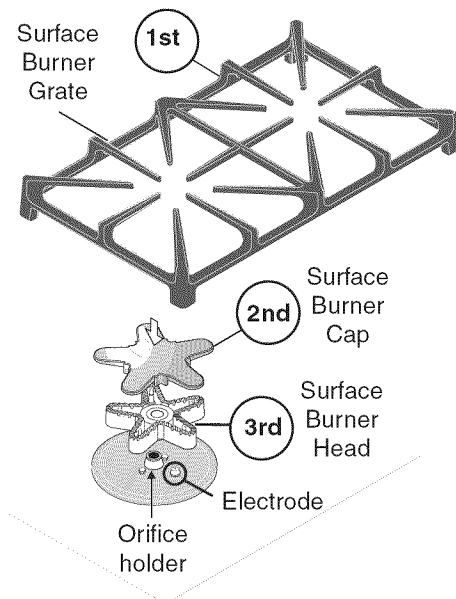

Figure 1

To Remove and Replace the Surface Burner Caps and Burner Heads -

Remove in the following order: (1st) surface Burner Grates, (2nd) Burner Caps and (3rd) Burner Heads. Replace in the following order: Burner Heads, Burner Caps and Burner Grates.

⚠ WARNING Do not remove any parts from the cooktop until they have completely cooled and are safe to handle. Do not operate the surface Burners without the Burner Caps and Burner Heads properly in place.

To Clean the surface Burner Caps and Burner Heads- Use a soap-filled scouring pad or a mild abrasive cleanser to clean the surface Burner Caps and Burner Heads. The ports (or slots) around the Burner Heads must be routinely cleaned. If residue still remains in these ports, use a small-gauge wire or needle to clean the slots or holes. For proper flow of gas and ignition of the burner—**DO NOT ALLOW SPILLS, FOOD, CLEANING AGENTS OR ANY OTHER MATERIAL TO ENTER THE GAS ORIFICE HOLDER OPENING. ALWAYS** keep the surface Burner Caps and Burner Heads in place whenever the gas Burners are in use.

To Clean the Burner Grates- The Burner Grates are dishwasher safe and may be cleaned in the dishwasher. Remove any excessive soils before placing in the dishwasher.

To Clean the Ceramic Glass Cooktop- See Ceramic Glass Cooktop Cleaning & Maintenance on next page.

General Care & Cleaning (cont'd)

Ceramic Glass Cooktop Cleaning and Maintenance

Consistent and proper cleaning is essential to maintaining your ceramic glass cooktop

Prior to using your cooktop for the first time, apply the recommended CookTop® Cleaning Creme to the ceramic surface (on the web visit www.sears.com for replacement cooktop cleaner, item number 40079). Buff with a **non-abrasive** cloth or **no-scratch** cleaning pad. This will make cleaning easier when soiled from cooking. The special cooktop cleaning cream leaves a protective finish on the glass to help prevent scratches and abrasions.

Sliding aluminum or copper clad bottom pans on the cooktop can cause metal markings on the cooktop surface. These marks should be removed **immediately** after the cooktop has cooled using the cooktop cleaning cream. Metal marks can become permanent if not removed prior to future use.

Cookware (cast iron, metal, ceramic or glass) with rough bottoms can mark or scratch the cooktop surface. **Do not slide anything metal or glass** across the cooktop. **Do not** use your cooktop as a cutting board or work surface in the kitchen. **Do not** cook foods directly on the cooktop surface without a pan. **Do not** drop heavy or hard objects on the glass cooktop, because they may cause it to crack.

Cleaning Recommendations for the Ceramic Glass Cooktop

CAUTION Before cleaning the cooktop, be sure the controls are turned to **OFF** and the cooktop is **COOL**.

WARNING DO NOT use a cooktop cleaner on a hot cooktop. The fumes can be hazardous to your health, and can chemically damage the ceramic-glass surface.

For light to moderate soil:

Apply a few drops of CookTop® Cleaning Creme directly to the cooktop. Use a paper towel or use a **non-abrasive** plastic type **no-scratch** cleaning pad to clean the entire cooktop surface. Make sure the cooktop is cleaned thoroughly, leaving no residue.

For heavy, burned on soil:

Apply a few drops of CookTop® Cleaning Creme directly to the soiled area. Rub the soiled area using a **non-abrasive** plastic type **no-scratch** cleaning pad, applying pressure as needed. Do not use the pad you use to clean the cooktop for any other purpose.

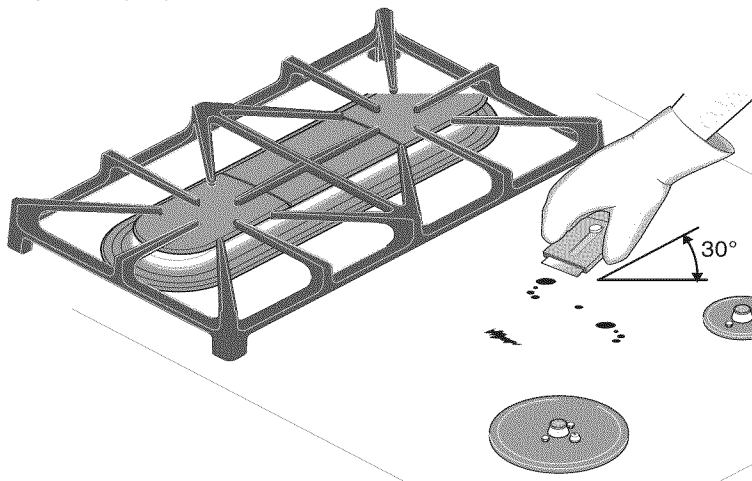

If soils remain, carefully scrape soils with a metal razor blade scraper, holding scraper at a 30 degree angle to the surface. Remove the loosened soils, then apply cooktop cleaning cream and use a paper towel or the non-abrasive pad to buff the surface clean.

IMPORTANT NOTE: Damage to the ceramic glass cooktop may occur if you use an abrasive type scratch pad. Only use cleaning products that have been specifically designed for ceramic glass cooktop.

Plastic or foods with a high sugar content:

These types of soils need be removed immediately if spilled or melted onto the ceramic cooktop surface. Permanent damage (such as pitting of the cooktop surface) may occur if not removed **immediately**. After turning the surface elements **OFF**, wear a mitt and use a razor blade scraper or a metal spatula to scrape the soil from the hot surface (as illustrated). Allow the cooktop to cool, and use the same method for heavy or burned on soils.

General Care & Cleaning (cont'd)



⚠ WARNING DO NOT use a cooktop cleaner on a hot cooktop. The fumes can be hazardous to your health, and can chemically damage the ceramic-glass surface. **Do not use commercial oven cleaners on any part of the cooktop. Damage to the finish or parts could result.**

Do not use the following on the ceramic glass cooktop

- Do not use abrasive cleaners and scouring pads, such as metal and some nylon pads. They may scratch the cooktop, making it more difficult to clean.
- Do not use harsh cleaners, such as chlorine bleach, ammonia or oven cleaners, as they may etch or discolor the cooktop.
- Do not use dirty sponges, cloths or paper towels, as they can leave soil or lint on the cooktop which can burn and cause discoloration.

Special Caution for Aluminum Foil and Aluminum Cooking Utensils

1) Aluminum foil

Use of aluminum foil will damage the cooktop. Do not use under any circumstances.

2) Aluminum utensils

The melting point of aluminum being much lower than that of other metals, care must be taken when aluminum pots or pans are used. Pans that boil dry may permanently damage cooktop by breaking, fusing to, or marking it.

Care and Cleaning of Stainless Steel

Some models are equipped with stainless steel exterior parts. Special care and cleaning are **required** for maintaining the appearance of stainless parts. Please refer to the table provided at the beginning of the **General Care & Cleaning** section.

Before You Call

Solutions To Common Problems

Before you call for service, review this list. It may save you time and expense. The list includes common occurrences that are not the result of defective workmanship or materials in this appliance.

OCCURRENCE	POSSIBLE CAUSE/SOLUTION
Oven Control Beeps and Displays any F code error (example F11).	Electronic control has detected a fault condition. Press any key to clear the display and stop the beeping. Reprogram the oven. If a fault reoccurs, record the fault number. Press any key and call Sears or another qualified servicer.
“d-o” is displayed.	The door was left open and controls set for self-cleaning cycle. Just close the door to correct the problem.
Appliance not level. Bad cooking results.	Place oven rack in center of oven. Place a level on the oven rack. Contact installing agent if rack and cabinet cutout flooring are not level.
	Kitchen cabinet misalignment may make oven appear to be not level. Be sure cabinets are square and level. Contact cabinet maker to correct problem.
Entire oven does not operate.	When the oven is first plugged in, or when the power supply to the oven has been interrupted, the display will flash. The oven cannot be programmed until the clock is set.
	Be sure electrical cord is securely connected into the electrical junction box.
	Cord/plug is not installed and/or connected. Cord is not supplied with oven. Contact Sears or another qualified servicer.
	Service wiring not complete. Contact Sears or another qualified servicer.
	Power outage. Check house lights to be sure. Call your local electric company.
	Short in cord/plug. Replace cord/plug.
	Controls are not set properly. See instructions under Setting Oven Controls to set the controls.
	House fuse has blown or circuit breaker has tripped immediately following installation. House fuse may not be fully engaged. Check fuse and screw or engage circuit breaker securely.
	House fuse has blown or circuit breaker has tripped after the oven has been installed and previously operating. Contact Sears or another qualified servicer.
Oven light does not work.	Burned-out or loose bulb. Follow the instructions under Changing Oven Light to replace or tighten the bulb.
Fan noise during cooking operation.	A cooling fan may automatically turn on and off to cool internal parts. This is normal, and the fan may continue to run even after oven is turned off.

Before You Call

Solutions To Common Problems

OCCURRENCE	POSSIBLE CAUSE / SOLUTION
Oven smokes excessively during broiling.	Oven door is closed. Door should be open during broiling.
	Meat too close to the broiler unit. Reposition the rack to provide more clearance between the meat and the broiler. Preheat broil element for quick searing operation.
	Meat not properly prepared. Remove excess fat from meat. Slash remaining fatty edges to prevent curling, but do not cut into the lean.
	Grid on broiler pan wrong-side up. Grease does not drain into broiler pan. Always place the grid on the broiler pan with the ribs up and the slots down to allow grease to drip into the pan.
	Broiler pan used without grid or grid cover with foil. DO NOT use the broiler pan without the grid or cover the grid with foil.
Oven needs to be cleaned. Grease has built up on oven surfaces. Regular cleaning is necessary when broiling frequently. Old grease or food spatters cause excessive smoking.	
Poor baking results.	Many factors affect baking results. See Baking for hints, causes and corrections. See Adjusting Oven Temperature .
Self-cleaning cycle does not work.	Make sure the oven door is closed.
	Controls not set properly. Follow instructions.
	Self-cleaning cycle was interrupted. Stop time must be set 2-4 hours past the start time. Follow steps under "Stopping or Interrupting a Self-Cleaning Cycle" in the Use & Care Guide.
Soil not completely removed after self-cleaning cycle is completed.	Failure to hand clean oven frame and door liner outside the oven door gasket before starting the self-clean cycle. Hand clean burned on residue with a stiff nylon brush and water or a nylon scrubber. Do not clean the oven door gasket or it will be damaged.
Flames inside oven or smoke from vent.	Excessive spillovers in oven. This is normal, especially for high oven temperatures, pie spillovers or for large amounts of grease on bottom of oven. Wipe up excessive spillovers.

Before You Call

Solutions To Common Problems

OCCURRENCE	POSSIBLE CAUSE/SOLUTION
Surface burners do not light	<p>Surface Control knob has not been completely turned to LITE. Push in and turn the Surface Control knob to LITE until burner ignites and then turn control to desired flame size.</p> <hr/> <p>Be sure gas supply valve is open.</p> <hr/> <p>Burner ports or slots are clogged. With the burner off, use a small-gauge wire or needle to clean ports or slots.</p> <hr/> <p>Power cord is disconnected from outlet (electric ignition models). Be sure cord is plugged securely into outlet.</p> <hr/> <p>Electrical power outage (electric ignition models). Burners can be lit manually. See Setting Surface Controls in this Use & Care Guide.</p>
Surface burner flame burns half way around	<p>Burner ports or slots are clogged. With the burner off, clean ports and slots with a small-gauge wire or needle.</p> <hr/> <p>Moisture is present after cleaning. To avoid this occurrence dry the burners thoroughly following instructions under General Care & Cleaning.</p>
Surface burner flame is orange	<p>Dust particles in main line. Allow the burner to operate a few minutes until flame turns blue.</p> <hr/> <p>In coastal areas, a slightly orange flame is unavoidable due to salt air.</p>
Scratches or abrasion on cooktop surface (Ceramic-Glass Cooktop)	<p>Coarse particles such as salt or sand between cooktop and utensil can cause scratches. Be sure cooktop surface and bottoms of utensils are clean before usage. Small scratches do not affect cooking and will become less visible with time.</p> <hr/> <p>Cleaning materials not recommended for ceramic-glass cooktop have been used. See "Ceramic Glass Cooktop Cleaning & Maintenance" section under General Care & Cleaning.</p> <hr/> <p>Cookware with rough bottom has been used. Use smooth, flat-bottomed cookware.</p>
Metalmarks (Ceramic-Glass Cooktop)	<p>Sliding or scraping of metal utensils on cooktop surface. Do not slide metal utensils on cooktop surface. Use ceramic-glass cooktop cleaning cream to remove the marks. See "Ceramic Glass Cooktop Cleaning & Maintenance" section under General Care & Cleaning.</p>
Brown streaks or specks on ceramic glass cooktop surface (Ceramic-Glass Cooktop)	<p>Boilovers are cooked onto surface. Use razor blade scraper to remove soil. See "Ceramic Glass Cooktop Cleaning & Maintenance" section under General Care & Cleaning.</p> <hr/> <p>Cleaning materials not recommended for ceramic-glass cooktop have been used. Use recommended cleaners and cleaning method. See "Ceramic Glass Cooktop Cleaning & Maintenance" section under General Care & Cleaning.</p>
Areas of discoloration with metallic sheen (Ceramic-Glass Cooktop)	<p>Mineral deposits from water and food. Remove using a ceramic-glass cooktop cleaning cream. To avoid this occurrence use cookware with clean, dry bottoms.</p>

Get it fixed, at your home or ours!

Your Home

For expert troubleshooting and home solutions advice:

manage  my home

www.managemyhome.com

For repair – **in your home** – of **all** major brand appliances, lawn and garden equipment, or heating and cooling systems, **no matter who made it, no matter who sold it!**

For the replacement parts, accessories and owner's manuals that you need to do-it-yourself.

For Sears professional installation of home appliances and items like garage door openers and water heaters.

1-800-4-MY-HOME[®] (1-800-469-4663)

Call anytime, day or night (U.S.A. and Canada)

www.sears.com www.sears.ca

Our Home

For repair of carry-in items like vacuums, lawn equipment, and electronics, call anytime for the location of your nearest

Sears Parts & Repair Service Center

1-800-488-1222 (U.S.A.)

www.sears.com

1-800-469-4663 (Canada)

www.sears.ca

To purchase a protection agreement on a product serviced by Sears:

1-800-827-6655 (U.S.A.)

1-800-361-6665 (Canada)

Para pedir servicio de reparación a domicilio, y para ordenar piezas:

1-888-SU-HOGAR[®]

(1-888-784-6427)

Au Canada pour service en français:

1-800-LE-FOYER^{MC}

(1-800-533-6937)

www.sears.ca

