

Dishwasher

Installation Instructions

Printed in U.S.A.
68500800012
09/10

INSTALLER: Leave *Installation Instructions* with owner.

OWNER: Read your dishwasher *Use and Care Manual*. It contains important safety information for operating this appliance. It also has many suggestions for getting the best results from your dishwasher.

Before You Begin

Read all instructions before installing dishwasher.

For your safety, please read and observe all safety instructions. This guide will help you anticipate drain, water, and electrical connections, and help you select the best location for the dishwasher.

WARNING

Tip Over Hazard

Do not use dishwasher until completely installed.

Do not push down on open door.

Failure to follow this warning can result in serious injury.

WARNING

Cut Hazard

To prevent serious injury from sharp edges, wear work gloves when handling, unpacking or disassembling unit.

Installation Tips

1

Tools and Materials Needed for Installation (Not Included)

- Drill, Electric
- Driver, Socket $\frac{5}{32}$ " , $\frac{1}{4}$ " , $\frac{5}{16}$ "
- Flaring Tool / Tube Cutter (for copper tubing)
- Flashlight
- Level
- Pipe Joint Compound (for iron pipe plumbing) or Pipe Thread Tape (for sealing threads)
- Pliers
- Safety Glasses
- Saw, Keyhole or $\frac{1}{2}$ " , $1\frac{1}{2}$ " to 2" Hole Cutters
- Screw Drivers, Slotted and #2 Phillips (magnetic tip preferred)
- Tape, Electrical or Duct
- Tape, Measuring
- Wire Stripper or Utility Knife
- Wrench, Hex-end
- Wrenches, 2 Adjustable (for copper tubing) or 2 Pipe wrenches (for iron pipe plumbing)

Parts You Will Need* (Not Included)

- Brass Elbow, 90° with a $\frac{3}{8}$ " National Pipe Thread
- Conduit Connector (UL Listed)
- Wire Nuts, three (3) for 12-14 gauge wire (UL Listed)

* If required:

- "Y" Branch Tailpiece and Connector Kit (See Step 4)
- Air Gap Kit (See Step 4)

All the parts can be found at local hardware, electrical and plumbing supply stores.

WARNING

Electric Shock Hazard

Disconnect electrical power at the fuse box or circuit breaker box before beginning installation. Failure to follow this warning could result in death or serious injury.

Installation Preparation

2

NOTE: Put unit on its back being careful not to pinch the Water Drain Hose.

1. Remove two (2) screws at front of the kickplate using a #2 Phillips screw driver.
2. Tilt and pull forward to remove see figure 1a.

NOTE: It is not necessary to remove the outer door for installation.

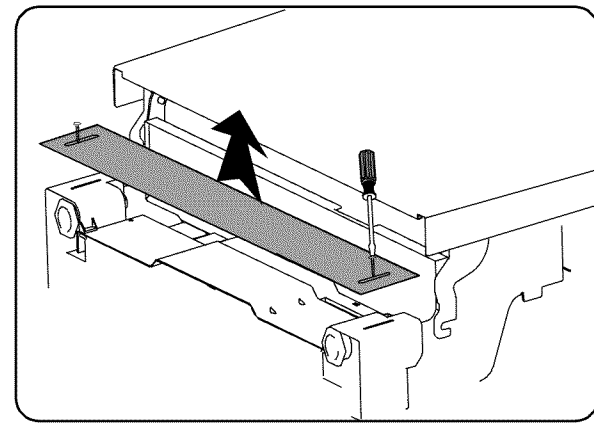

Figure 1a

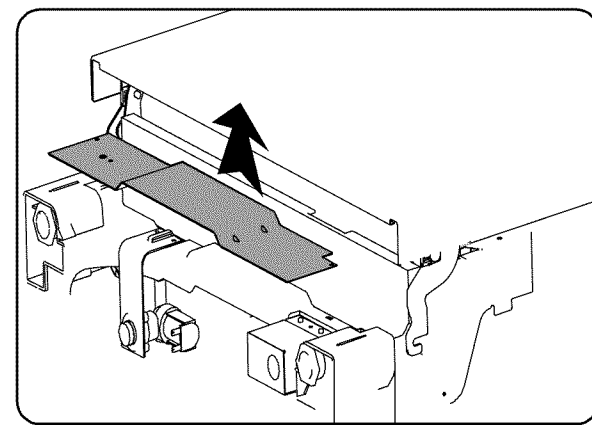

Figure 1b

3. Remove two (2) screws at front of the kickplate brace using a #2 Phillips screw driver. Slide up and pull off.
4. Locate water inlet valve behind kickplate on bottom left underside of unit. See Figure 4. The valve has a $\frac{3}{8}$ " NPT female fitting.
5. Wrap 90° elbow (not included) with pipe thread tape (or apply joint compound) and thread it into water inlet valve. When tightened, elbow should point toward the left. To prevent bending of bracket or breaking of valve, avoid overtightening. See Figure 4.

Cabinet Preparation:

As a precaution, it is recommended, but not required that the cabinets enclosing all sides of the dishwasher (including the underside of the countertop) be sealed with an oil based paint or moisture-proof polyurethane to prevent possible steam/moisture damage.

Roughing In

3

WARNING

Electric Shock Hazard

Observe all local codes and ordinances for electrical and plumbing connections. All electrical and plumbing work should be performed by qualified persons. Failure to follow this warning could result in death or serious injury.

1. Make sure your location has the correct drain, water, and electrical outlets to make the connections. Do not install unit under a cooktop range. Damage to tub or other components will occur.
2. Floor should be flat and free of any obstruction.

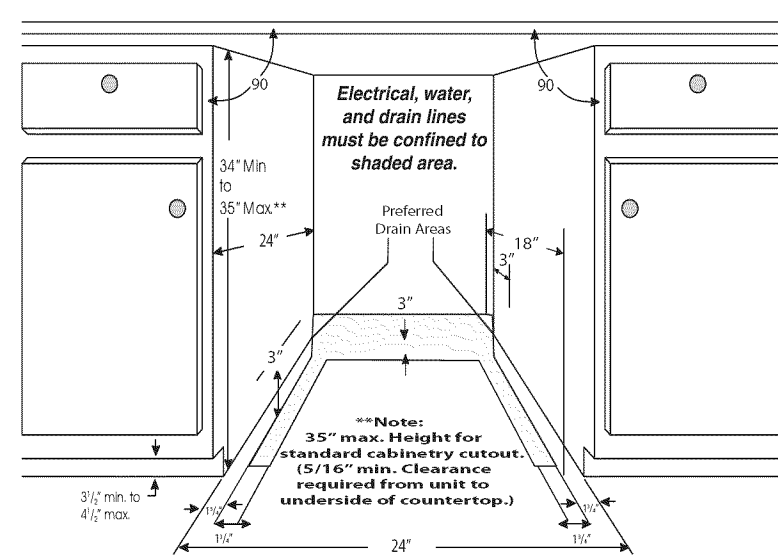
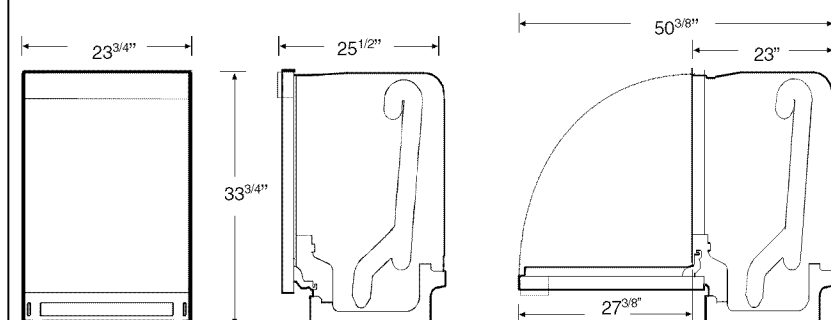

Figure 2



Front
Figure 3

Left

Right

*DIMENSIONS DO NOT INCLUDE INSULATION

IMPORTANT: For proper operation and appearance of unit, cabinet opening should have dimensions as shown in Figure 2. If unit is to be placed in a corner, there must be at least a 2-inch side clearance to open door.

IMPORTANT: Drain, water, and electrical lines should be roughed-in before going any further.

WARNING

Electric Shock Hazard

Electrical, water, and drain lines must be confined to shaded areas in Figure 2. Electric conductors, water, and drain could be damaged. Failure to follow these instructions could result in fire or electric shock.

NOTE: If dishwasher is installed at end of a cabinet, sides and back must be fully enclosed.

Connections For Electrical, Water, and Drain

4

Locating the Connections

1. Review dimensions in Figure 2 to locate dishwasher's drain, water, and electrical connections.

2. All utilities must be routed in shaded area in the Figure 2.

IMPORTANT: Disconnect power before starting installation.

Note: Locate the electrical supply and dishwasher's electrical

junction box on right underside of unit behind kickplate assembly. See Figure 4. Determine where you will connect to hot water supply. Review Figure 4 and note the location of water inlet valve. Determine where you will connect the drain hose.

3. Cut access holes for the Electrical, Water and Drain hoses in the shaded areas as shown in Figure 2.
4. The dishwasher operates on a 120 volt, 60 Hz electrical supply. Provide a separate circuit with a fuse or circuit breaker rated for at least 15 amps (20 amps if connected with disposer) but not more than 20 amps.
5. Pull electrical cable through hole into installation area.
6. Be sure water inlet valve is protected from freezing. If valve freezes and ruptures, flooding may occur.
7. Determine amount of tubing needed to connect hot water supply to the unit's water inlet valve. **Extra hose length is necessary.** High-pressure and high-temperature Stainless Flexible hose with a minimum inner diameter of $\frac{1}{4}$ " may be used. A shut-off valve installed **outside** dishwasher cabinet is best.
8. Route water supply line into installation area.
9. Stand dishwasher back upright for further installation.

IMPORTANT: Incoming hot water temperature should be at least 120°F (49°C). Water pressure should be between 20–90 psi.

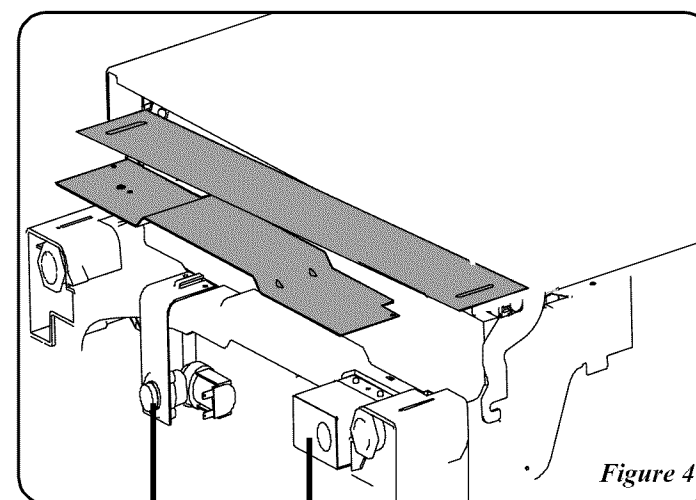

Figure 4

WATER LINE (NOT INCLUDED) ELECTRICAL BOX

CAUTION

Property Damage

Do not use the furnished drain hose or a rubber garden hose for the water supply line. Either of these hoses can burst. Flooding may occur and cause property damage.

Leveling and Securing Dishwasher within Cabinets

5

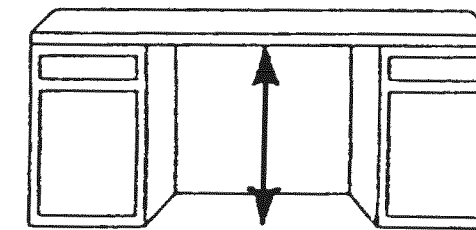

1. Measure height of cabinet opening from underside of countertop to floor.
2. Move dishwasher to front of installation area.
3. Loosen the rear leveling legs by turning counterclockwise.

Dishwasher Anchoring

5. Choose one of the methods of attachment below to secure unit, holes need to be pre-drilled using a #5 drill bit regardless of the option chosen:
 - a. Top Mount Cabinet Clips (Preferred Method of attachment)
 - b. Side Mount Cabinet Clips (to be used when Top Mount is not an available option)

CAUTION: Use extreme care in mounting the dishwasher as to not scratch, bump or otherwise damage the console or tub.

To install using Top Mount Cabinet Clips:

Depending on the depth of cabinet, the Top Mount Clip have a break off point that can be removed if necessary.

NOTE: Install Top Mount Clips before unit is installed into the cabinet. Insert the installation brackets to the front top slots of the dishwasher. (See image below)

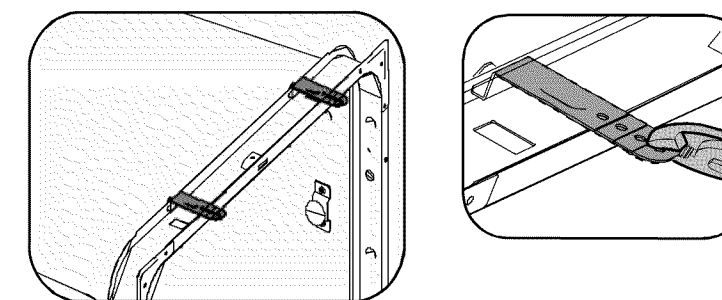

To install the Side Mounting Clips.

Depending on space allowed in cabinet the Side Mounting Clips can be installed with the holes for the screw up (preferred method) or down as shown in the illustrations below.

NOTE: Install Side Mount Brackets before unit is installed into the cabinet. Insert the installation brackets to the side slots of the dishwasher. (See image below)

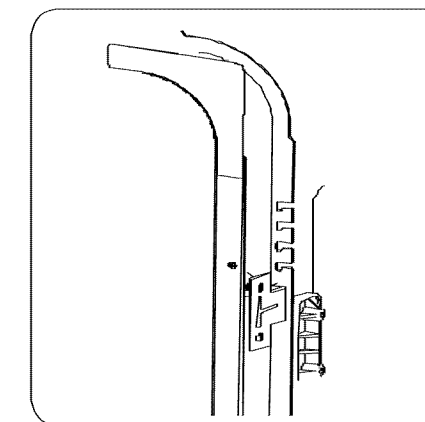

6. If levelers need to be removed, make sure that the floor is free of all obstructions.

7. Carefully place dishwasher inside cabinet area such that is centered in opening. Use caution when moving dishwasher to prevent damage to cabinet, dishwasher and floor.

8. Front of door needs to be even with the front of adjoining cabinets. Front levelers should allow $\frac{5}{16}$ " below underside of countertop to top of console.

9. Check that dishwasher is level from side to side by placing a level against the top front section of the tub. See Figure 5a.

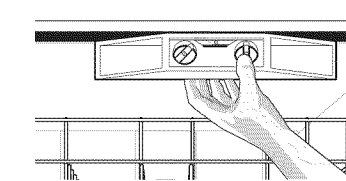

Figure 5a

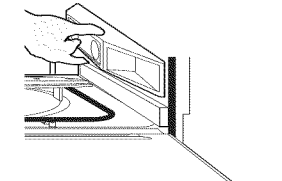

Figure 5b

10. Check that the dishwasher is level from front to back by taking out the lower rack, place level on the lower rack wheel support at the bottom of the tub. See Figure 5b.

11. Adjust levelers up or down until dishwasher is level.

Holes need to be pre-drilled using a #5 drill to secure unit.

12. Screw mounting brackets firmly to cabinet using screws provided in literature packet. See Image Below.

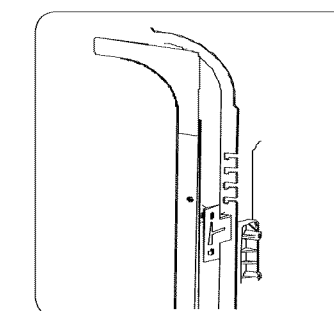

Figure 5c

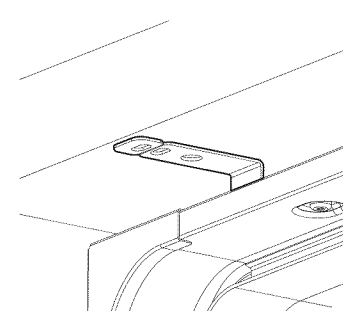
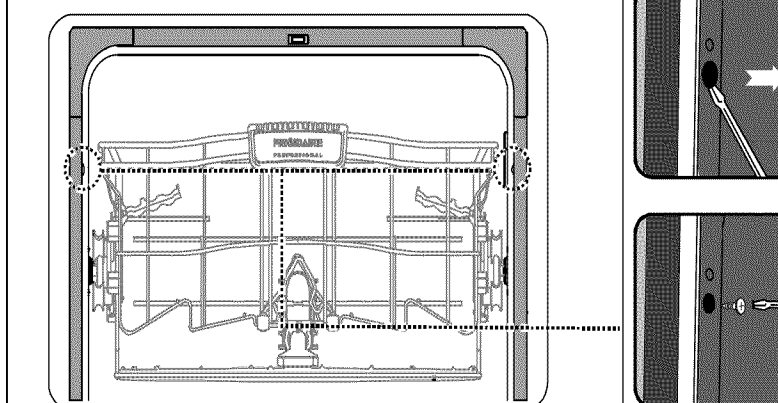

Figure 5d

13. Open the door remove the tub cap on both sides of the tub. Install screw through the dishwasher side hole to the wall of cabinet. Reinstall tub cap.



14. Open and close dishwasher door slowly. Ensure that there is clearance to the console. Adjust accordingly until door opens and closes freely.

Finishing the Water and Electrical Connection 6

CAUTION

Property Damage

Do not solder within 6" of the water inlet valve. Damage to the plastic parts in the valve may occur.

Use care that no sealer, dirt, or other objects enter the valve. Damage to the filter screen may occur.

Be sure the dishwasher is placed where the water inlet valve will be kept from freezing. If the valve freezes, it may rupture and flooding may occur.

Water Line

1. Flush water line before connecting it to water inlet valve to prevent early clogging of filter screen. Place a bunched towel over end of line to prevent splashing. Open water supply valve for a few seconds and let water drain into a pan. **Turn off water supply at shut-off valve.**
2. Route water line to water inlet valve as shown in **Figure 4**.
3. While firmly pulling water supply line into 90° elbow, tightly connect water supply to water inlet valve. Supply line must be free of kinks, scales, chips, and lubricants.
4. Turn on water supply and check for leaks.

Electrical Supply

1. Remove junction box cover and pull house wiring into junction box. **See Figures Below.**
2. Use a UL listed conduit connector (not included) at box to stabilize wiring.
3. Connect incoming black lead to dishwasher's black lead, incoming white lead to dishwasher's white lead and incoming green lead to dishwasher's green lead with wire nuts. (See Grounding Instruction Warning). Wire nuts must be tight.

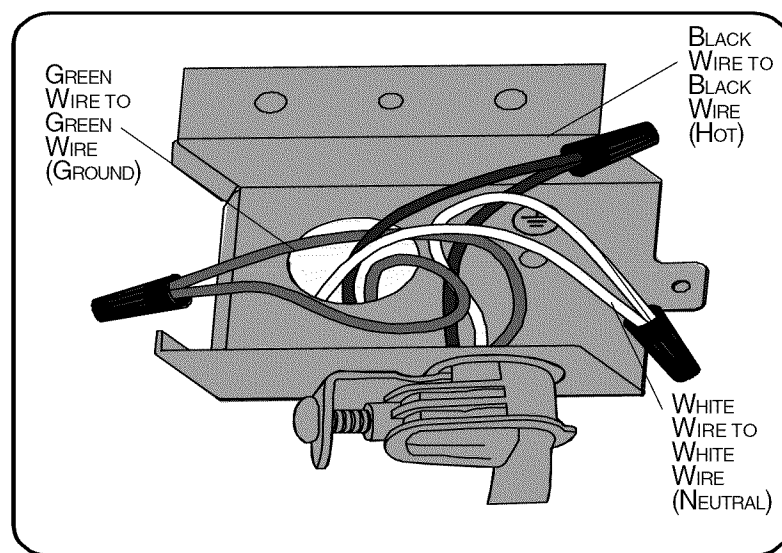
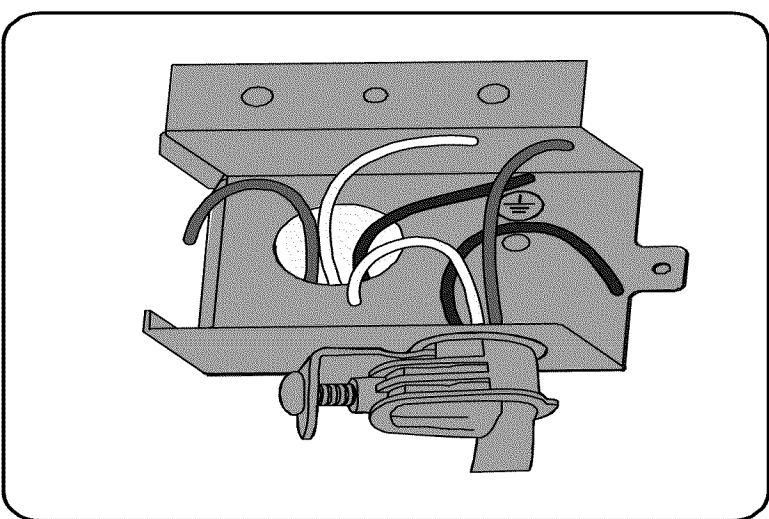
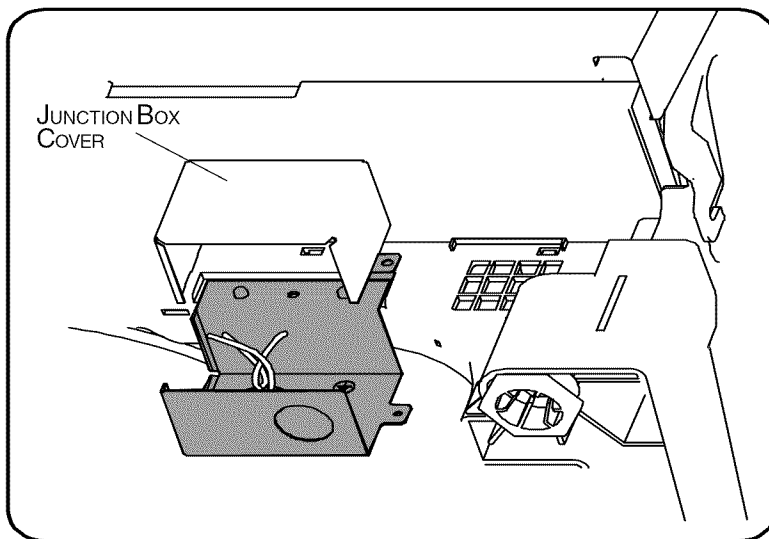

Figures 6a

4. Replace junction box cover.

check these items:

- Water and electrical lines are hooked up to dishwasher.
- All four leg levelers are positioned properly.
- Cabinet Seals are positioned on the sides and top of the dishwasher.
- Cabinet Attachment Clips are attached to the cabinet or countertop and kickplate brace.
- Replace Toe and Kickplate. **Note: When replacing Kickplate and kickplate brace hand tighten screws.**

WARNING



Electric Shock Hazard

Grounding Instructions:

The dishwasher must be connected to a grounded metal, permanent wiring system or an equipment-grounding conductor must be run with the circuit conductors and connected to the appliance's equipment grounding terminal or lead. It is the consumer's responsibility to contact a qualified installer to make sure the electrical installation conforms with the National Electrical Code and local codes and ordinances.

Do not connect the dishwasher to the power supply until the appliance is permanently grounded.

All wiring connections must be enclosed in the junction box. This unit has copper lead wires.

Joining aluminum building wire to stranded copper wire should be done by a qualified electrician using materials recognized by UL and local codes.

Do not use an extension cord. Such use can result in fire, electrical shock, or other personal injury.

Failure to follow these instructions could result in death or serious injury.

Finishing the Drain Connection 7

1. Review **Figures 7, 8 and 9** to see the different ways to connect dishwasher to drain system. Choose method that best suits your need.

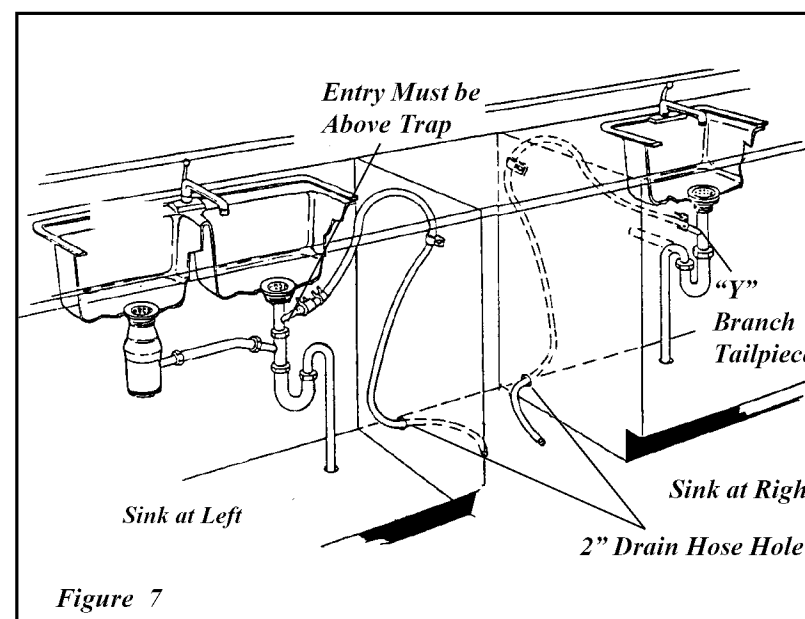

Figure 7

The drain hose loop must be at least 32" high from the floor to insure proper drainage.

2. If you connect to a sink drain, entry will need to be above trap. A "Y" branch tailpiece and connector kit, not included, will make this method easier and includes all needed fittings and instructions. **See Figure 7.**

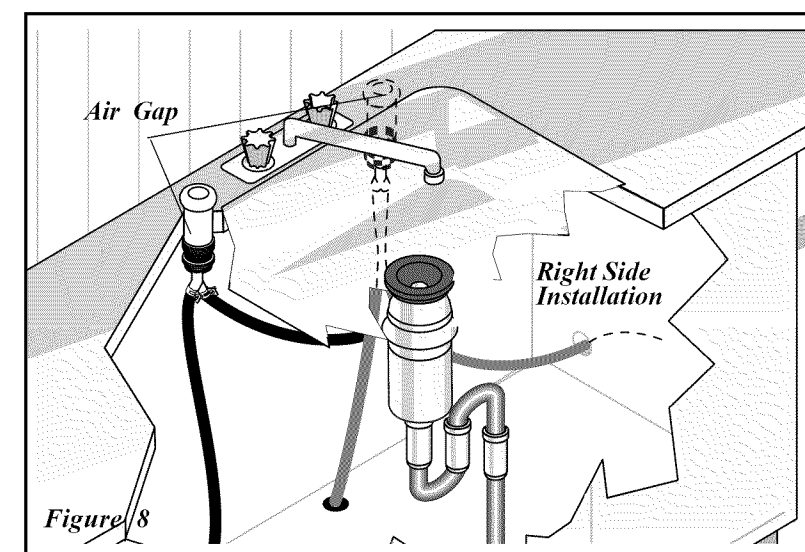

Figure 8

3. If you connect to a sink trap, local codes may require you to install an air gap kit, (not included). The drain hose will be routed from dishwasher to air gap inlet as shown in **Figure 8**. An air gap kit is available from a plumbing supply store. (If the drain hose is installed through the floor, an air gap is necessary).
4. If you connect to a disposer, the large end of drain hose will fit. **Figure 9(a). The knock out plug must be removed from inside disposer inlet before making the final fit to drain hose.** See **Figure 9(b).**

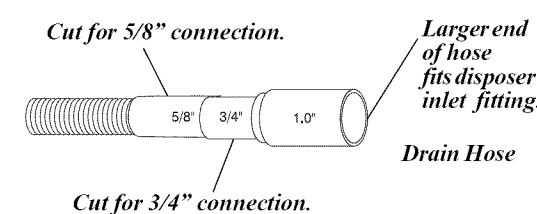

Figure 9(a)

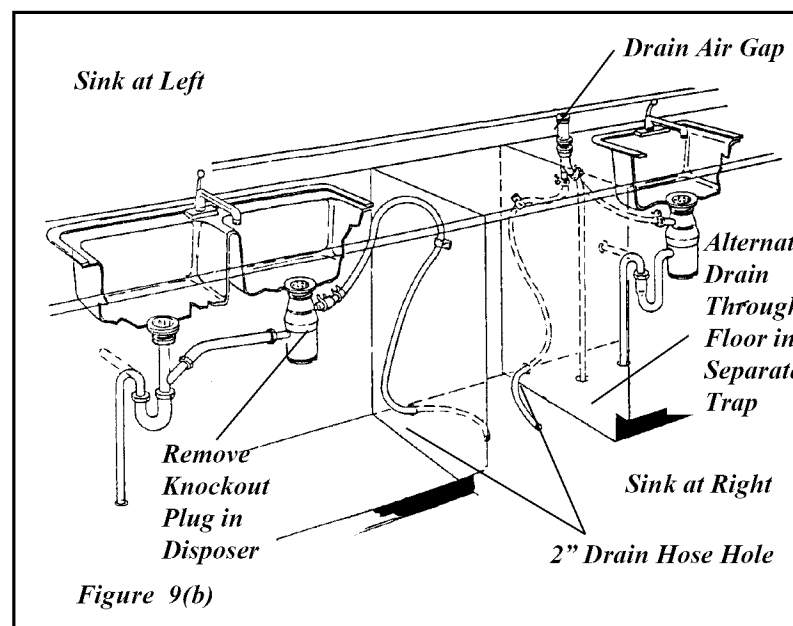
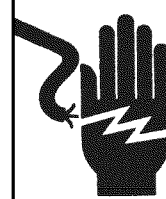

Figure 9(b)

The drain hose loop must be at least 32" high from the floor to insure proper drainage.

5. If the cabinet wall is wood, sand edges of hole until smooth and rounded. If cabinet wall is metal, cover all sharp edges with electrical or duct tape to avoid cutting drain hose.
6. Move unit back in place while routing drain hose through access hole. Use caution to prevent damage to the dishwasher, floor and cabinets. **IMPORTANT: Make sure there are no sharp bends or kinks that might restrict drain flow.**
7. Secure drain hose to sink drain, disposer, or separate trap with a clamp. **IMPORTANT: Be careful not to overtighten clamp or you may damage end of hose.** Do not connect hose to horizontal pipe between sink drain and disposer.
8. Be sure unit does not rest on drain hose. It should be free of electrical components and door springs. Do not cut corrugated drain hose. Pull excess through cabinet and place under sink. Make sure hose does not come in contact with any sharp edges.

WARNING



Electric Shock Hazard

Disconnect electrical power at the fuse box or circuit breaker box before beginning installation.

Failure to follow this warning could result in death or serious injury.

CAUTION

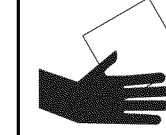

Cut Hazard

Metal color panels are sharp and should be handled with care. Wear gloves to protect hands.

Failure to follow this warning may result in injury.

WARNING



Electric Shock Hazard

If all connections are correct, there are no leaks, and unit runs properly, replace the kickplate assembly before placing unit into operation.

Failure to follow this warning could result in electric shock.

check these items:

- Water and drain lines have no kinks and move freely behind the dishwasher.
- Water supply is turned on.
- Joints are free of leaks.
- Wiring connections to junction box are tight all access panels are secured back in place.
- Replace kickplate and kickplate brace. (See **Figure 1**)
- Drain hose is assembled to Drain Hose Connector.
- All packing materials and consumer literature have been removed from inside unit.
- Dishwasher is level and securely fastened.
- Open and close door to make sure it does not hit surrounding cabinet or countertop.
- Make sure that all tape is removed from the Silverware Baskets.

Checking the Installation 8

Operate the machine through at least one fill and pump-out, checking the following items:

- At first fill, approximately 1 minute make sure water completely covers filter surface.
- At pump-out: (pump-out is either when the cycle is completed or canceled. refer to the Use and Care Manual for Start/Cancel), make sure all water is pumped out.
- Check water connections again for leaks.