

# SEARS Installation Instructions

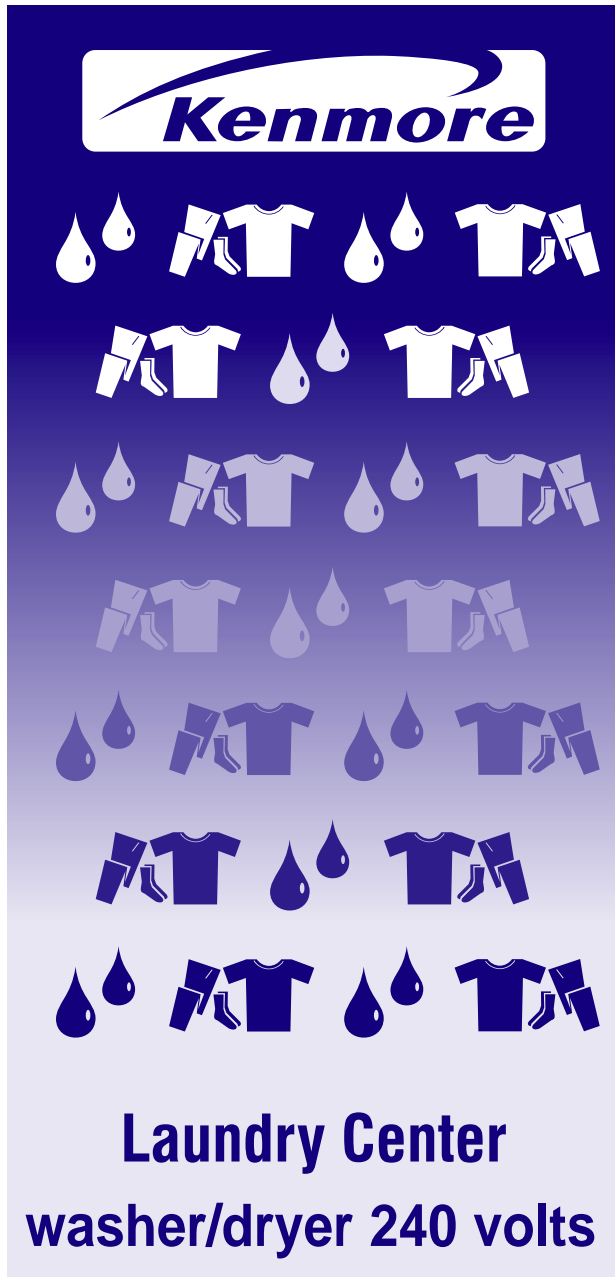

Before you begin .....	2
Location .....	2
Recommended grounding instructions .....	2
Electrical requirements .....	2
Exhaust requirements .....	3
Water supply and drain requirements .....	3
Please begin .....	3
Alternate installations .....	5
Alternate methods of securing drain hose .....	5
Alternate exhaust methods .....	6
Alternate electrical connection .....	6
Rough-in dimensions .....	8

## Save These Instructions

Sears, Roebuck and Co., Hoffman Estates, IL 60179 U.S.A.

## Before you begin . . .

Please read these instructions all the way through.

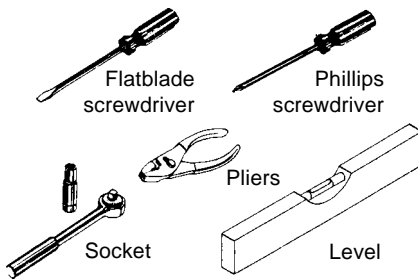

**A.** You need these tools to install your Kenmore Laundry Center. Get them together in one place to keep track of them.

**B.** Check the spot where you are going to install the Laundry Center. Proper installation is your responsibility. Make sure you have everything necessary for proper installation.

**⚠ WARNING** You will need to meet **State code/law requirements:** Some Codes keep from or limit installation of clothes dryers in residential garages, closets, mobile homes and sleeping quarters. (Check with your local building inspector.)

**Important: Observe all governing codes and ordinances.**

## Location

**Size:** Must be large enough to fully open dryer door. For recessed or closet installations see Page 5 for spacing; for product dimensions see the last page of these instructions.

**Support:** The floor must be able to support the appliance loaded weight of 500 pounds.

**Level Floor:** Maximum floor slope under Laundry Center is 1 inch.

**Protection from the weather:** Proper operation of dryer cycles requires temperatures above 45°F. As some water remains in the washer, do not store or operate the washer below 32°F. For storage below 32°F. see Use and Care Guide for "Winterizing."

## ⚠ WARNING

⚠ It is the personal responsibility of the customer to ensure that gasoline, paint, thinners and other flammable materials are not used or stored near the Laundry Center. Fumes from these materials could result in fire, explosion or personal injury.

⚠ **Never** install the Laundry Center up against draperies or curtains and be sure to keep any and all items from falling or collecting behind the Laundry Center.

⚠ Replace all access or service panels before operating Laundry Center.

## Recommended grounding instructions Electrical ground is required on this appliance.

This appliance must be grounded. In the event of malfunction or breakdown, grounding will reduce the risk of electric shock by providing a path of least resistance for electric current.

⚠ **WARNING** Improper connection of the equipment-grounding conductor can result in a risk of electric shock. Check with a qualified electrician or serviceman if you are in doubt as to whether the appliance is properly grounded.

## Electrical requirements

1. A 3-wire single phase 120/240 volt 60Hz AC only electrical supply (or 3-wire 120/208 volt if specified on nameplate) is required on a separate 30 ampere circuit, fused on both sides of the line (time-delay fuse or circuit breaker is recommended). Do not have a fuse in the neutral or ground circuit.
2. If a power supply cord is used, it must be a 30 amp rated flexible type with three open end spade lug connectors with upturned ends or closed loop terminal connectors. A U.L. recognized strain relief (U.L. mark on it or Sears Part No. 687000) to fit a one inch hole must be used.

When local codes permit, it must be plugged into a mating 30 amp receptacle (NEMA) type 10-30R. See Figure 1.



Figure 1  
3-wire receptacle  
(10-30R)

3. The appliance may be connected directly to the fused disconnect (or circuit breaker) box through flexible armored or nonmetallic sheathed 10 gauge CUPPER cable. **DO NOT USE ALUMINUM WIRE.** It is the personal responsibility and obligation of the customer to contact a qualified installer to assure that the electrical installation is adequate and is in conformance with the National Electrical Code and local codes and ordinances. A U.L. recognized strain relief must be provided at each end of the power supply cable (at the appliance and at the junction box). Wire sizes (10 gauge CUPPER WIRE ONLY) and connection must conform with the rating of the appliance (30 amperes). **DO NOT USE AN EXTENSION CORD.**
4. **⚠ WARNING** For mobile home installation, the appliance frame must not be connected to the neutral terminal, but must be connected to the ground cord (see Page 6, Alternate Electrical Connection, for detailed instructions).

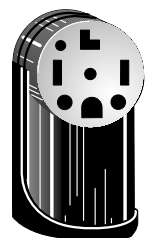

Figure 2  
4-wire receptacle  
(14-30R)

Typical 30 Amp receptacle use: Use where local codes permit flexible type supply cord (pigtail).

If a 4-wire single phase 120/240 volt 60Hz AC receptacle of NEMA type 14-30R (see Figure 2) is available, a matching power supply cord (pigtail) must be used. This cord contains 4 No. 10 gauge copper conductors with spade or ring terminals on the Laundry Center end and terminating in a NEMA type 14-30P plug on supply end. The fourth

(grounding) conductor must be identified by a green cover and the neutral conductor by a white cover. Cord should be type SRD or SRDT, with a U.L. recognized strain relief, and be at least 3 feet and no more than 6 feet long. The 4-wire power supply cord and strain relief are not provided with the Laundry Center.

NOTE: Laundry Center dryers operating on 208 volt power supply will have longer drying times than dryers operating on 240 volt power supply.

## Exhaust requirements

**Four Inch Metal Exhaust Duct** is required. (Do not use 3-inch exhaust duct.) **Metal** flexible duct may be used. **DO NOT USE PLASTIC FLEXIBLE DUCT.**

### **⚠ WARNING** For Safety:

**⚠** Do not exhaust dryer into a chimney, furnace cold air duct, attic or crawl space, or any other duct used for venting. Accumulated lint could become a fire hazard or moisture could cause damage.

**⚠** The exhaust system should be cleaned periodically, at least every 18 months.

**⚠** Flexible duct should never be installed concealed in walls, ceiling or floor.

**Use Duct Tape** to seal all joints.

**Exhausting the dryer outside** is recommended.



**For Mobile Home Exhaust Requirements** see Page 6, Alternate Exhaust Methods, for detailed instructions.

The **Exhaust Duct** should end with an Exhaust Hood to prevent exhausted air returning into dryer. The outlet of the hood must be at least 12 inches from the ground or anything else that may be in the path of the exhaust.

A **2-1/2 inch outlet Exhaust Hood** should be used with short systems only. This outlet creates greater backward pressure than other hood types.

**Exhaust Hoods** with screen or magnetic latches should not be used.

The **Maximum Length** of the exhaust system depends upon the type of duct used, number of elbows and type of exhaust hood. The maximum length for both rigid and flexible duct is shown in chart.

EXHAUST DUCT LENGTHS (FEET)			
Number of 90° Turns	EXHAUST HOOD TYPE		
	 4"	 LOUVERED	 2 1/2"
MAXIMUM LENGTH OF 4-INCH DIAMETER RIGID METAL DUCT			
0	56'	56'	42'
1	46'	46'	36'
2	34'	34'	28'
3	32'	32'	18'
MAXIMUM LENGTH OF 4-INCH DIAMETER FLEXIBLE METAL DUCT			
0	30'	30'	22'
1	22'	22'	14'
2	16'	16'	10'
3	10'	10'	5'

**Exhaust Systems** longer than specified will:

- Shorten the life of the dryer.
- Reduce the performance, such as cause longer drying times and increases the use of energy.
- Accumulate lint.

The Laundry Center may be exhausted four (4) ways with rear **flush** installation:

1. **Straight back.**
2. **Down** (8" length of 4" rigid duct and 1 elbow down).
3. **Left** (8" length of 4" rigid duct, 1 elbow down and 1 elbow left).
4. **Right** (8" length of 4" rigid duct, 1 elbow down and 1 elbow right).

To exhaust up, add an 11" length of standard 4" diameter duct and a 90° elbow. The unit will be positioned about 4-1/2" away from the wall (flush to wall exhausting may be done by going below the dryer then sideways.)

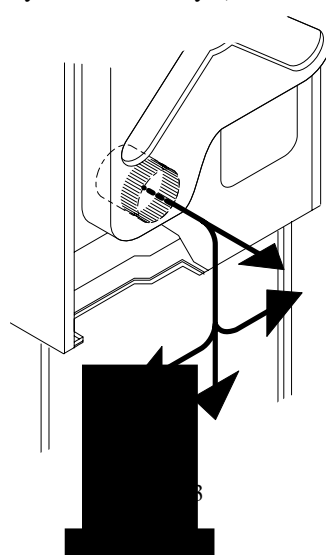

## Water supply and drain requirements

**Hot and Cold** water faucets within 4 feet of back of the Laundry Center and enough pressure (5-100 PSI) are required.

**Water Heater** should be set to deliver 130°F. or above water to the washer for best results.

To drain the Laundry Center washer, you need either a 20-gallon laundry tub or 1-1/4 inch diameter standpipe having a minimum carry-away capacity of 16 gallons per minute. The minimum tub or standpipe height is 33 inches from the bottom of the washer. The maximum tub or standpipe height is 96 inches from the bottom of the washer. For installations requiring a longer drain hose, have a qualified technician install a longer hose, P/N 131461201. For drain systems in the floor, install a siphon break kit, P/N 076660-000. Both components are available from Sears Parts Department.

## PLEASE BEGIN. . .

1. Remove:
  - (a) foam tub blocking pad;
  - (b) foam shipping blocks from rear of unit;
  - (c) tape from dryer door;
  - (d) foam dryer support pads;
  - (e) inlet hoses.
  - (f) From the back of the washer, remove the wire shipping clips securing the drain hose and power cord. Plastic clamps secure the drain hose to the right side of the washer backsheet. These clamps form a standpipe to prevent water siphoning. **DO NOT REMOVE THESE CLAMPS.**

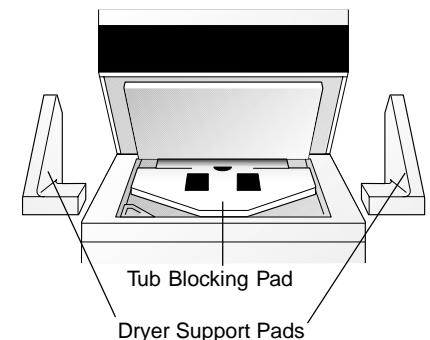

- 2.** Using the four shipping carton corner posts (two on each side), carefully lay the Laundry Center on its left side and remove the foam shipping base.

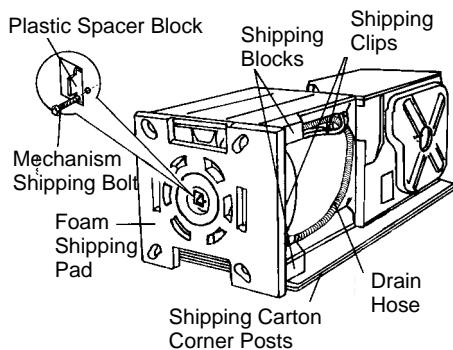

- 3.** Using the ratchet with 3/8 inch socket, remove mechanism shipping bolt. Remove plastic spacer block from center of base using adjustable pliers.

NOTE: If the Laundry Center is to be transported at a later date, the tub blocking pad, shipping bolt and plastic spacer block should be retained.

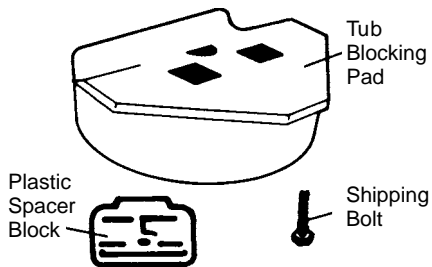

- 4.** Return Laundry Center to upright position.

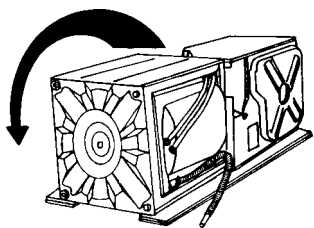

- 5.** Install 3-wire power supply cord.

- Remove the terminal block cover located at the rear of the dryer.
- Install U.L. approved strain relief (Figure 11) in one inch hole on dryer back below terminal block opening.
- Thread U.L. approved 30 amp power cord through strain relief.
- Connect the center wire of the power cord to the center silver colored terminal screw of the terminal block and tighten securely.
- Connect the other wires to the outer terminals and tighten securely (Figure 12).
- Replace the terminal block cover.

- 6.** Run some water from the hot and cold faucets to flush the water lines and remove particles that might clog up the water valve screens. Check inlet hoses to ensure the rubber washers are installed in each end. Carefully connect the inlet hoses to the water valve (on the left side of the washer cabinet), tighten by hand, then tighten another 2/3 turn with pliers.

**CAUTION DO NOT CROSS THREAD OR OVERTIGHTEN THESE CONNECTIONS.**

- 7.** Determine which water faucet is the **HOT** water faucet and carefully connect the bottom inlet hose to the **HOT** water faucet, tighten by hand, then tighten another 2/3 turn with pliers. Carefully connect the top inlet hose to the **COLD** water faucet, tighten by hand, then tighten another 2/3 turn with pliers.

**CAUTION DO NOT CROSS THREAD OR OVERTIGHTEN THESE CONNECTIONS.**

Turn the water on and check for leaks at both connections.

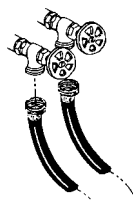

- 8.** Form a "U" shape on the end of the drain hose with the hose pointed toward the drain. Place the formed end in a laundry tub or a standpipe and secure with a cable tie provided in the enclosure package.

**CAUTION WATER COULD SIPHON FROM THE LAUNDRY CENTER IF THE ABOVE INSTRUCTIONS ARE NOT FOLLOWED.**

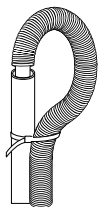

- 9.** Carefully move the laundry center to its final location. Plug the power cord into a grounded outlet.



- 10.** To make sure the Laundry Center is solid and level, tilt the machine forward so the rear legs are off the ground. Gently set the machine back down to allow the rear legs to self adjust. Place a level on top of the washer. Check it side to side, then front to back. Screw the front leveling legs up or down to make sure the unit is solid on all four legs (no rocking of the appliance should exist).

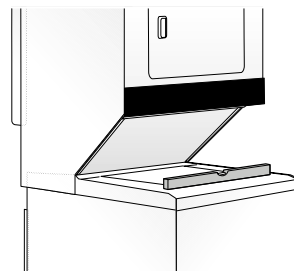

- 11.** Remove two (2) screws securing front access panel to dryer cabinet. Lower panel until bottom tabs can be disengaged from cabinet, remove panel, and set aside.

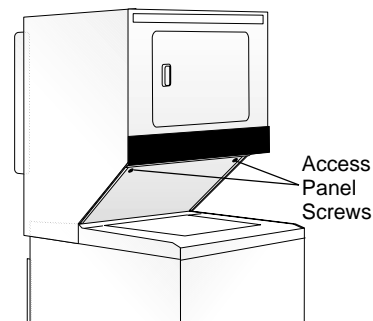

- 12.** Connect exhaust duct to outside ductwork. Use duct tape to seal all joints. Do not exceed the length of duct pipe or number of elbows allowed in the Maximum Length Chart, Page 3. Install the exhaust duct as described in Exhaust Requirements, Page 3, and refer to the drawings below. To exhaust inside, refer to Alternate Exhaust Methods, Page 6.

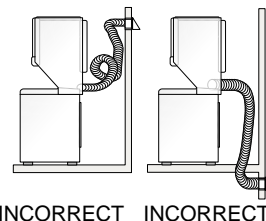
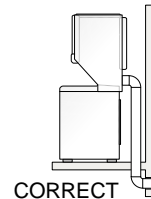



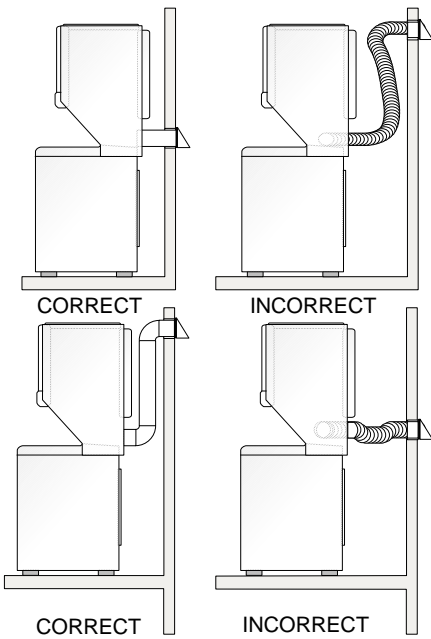

### Alternate installations: recessed or closet area locations.

The following are minimum installation spacings and openings (in inches) that you should allow. For easier installation and service, consider additional spacing.

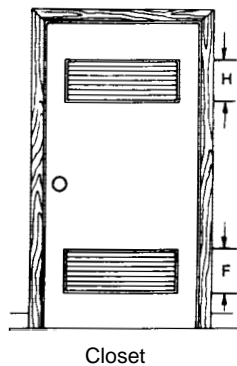
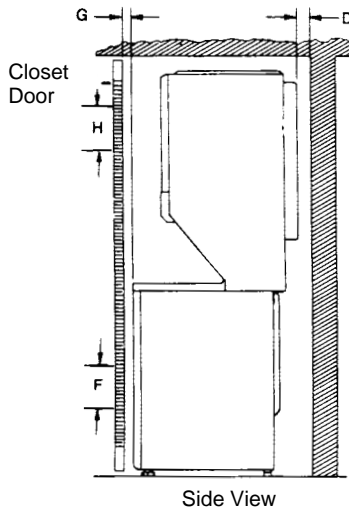
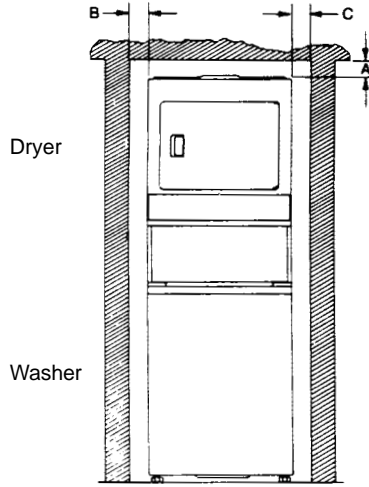

### Minimum Installation Spacing

RECESS INSTALLATION	A	B	C	D	F	G	H
INSIDE EXHAUST	4	0	4	0			
OUTSIDE EXHAUST	1	0	0	0			

CLOSET INSTALLATION	A	B	C	D	F	G	H
OUTSIDE EXHAUST ONLY	1	0	0	0	60 SQ.IN.	1	60 SQ.IN.

When the Laundry Center is installed in other than the recessed and closet type of installation shown, minimum dimensions indicated must be observed.

To prevent large amounts of lint and moisture from accumulating and to maintain drying efficiency, this appliance must be exhausted outdoors.

Non-exhausted installation-only rear exhaust position permitted.

**13.** Read and save the Operating Instructions and the Use and Care Guide that came with the Laundry Center.

**14.** Clean the dryer drum and washer tub with a damp cloth.

**15.** Turn on electricity at power source.

**16.** Start washer and dryer. RUN THROUGH ONE COMPLETE CYCLE and check for possible leaks, exhaust connections and tub drainage.

**17.** Reinstall access panel.

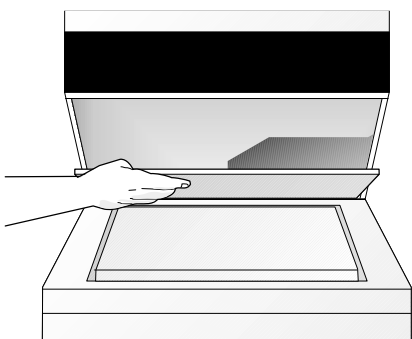

### Alternate methods of securing drain hose

**A.** Put the bent end of the drain hose in the tub or standpipe.

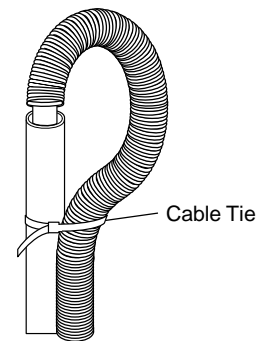

Figure 3

**B.** The drain hose must be held securely with the cable tie so it does not come out of the standpipe during use.

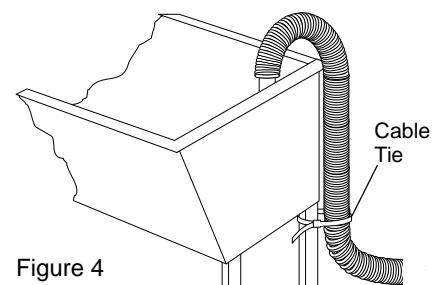
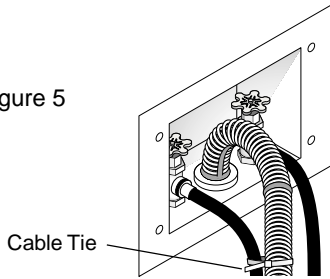

Figure 4

**C.** Secure the hose as shown in Figures 3 Standpipe, 4 Tub, 5 In wall standpipe.

Figure 5



BE SURE THE HOSE IS NOT TWISTED OR KINKED AND IS SECURELY IN PLACE.

## Alternate Exhaust Methods

**A.** There are exhaust kits available that allow you to direct filtered exhaust air inside to conserve energy during winter months. You may use these devices with the Laundry Center dryer providing their use does not violate national or local codes, and the device does not restrict exhaust air flow. If you use one of these kits, be aware that excessive moisture in the home can cause many problems and that you may see an increase in the time required to dry a load. Also, you must maintain the kit installation properly to avoid excessive lint buildup, which can affect the dryer's performance.

**B.** For mobile home installation, the dryer **must** have an outside exhaust. If you exhaust the dryer through the floor and the area under your mobile home is enclosed, the exhaust system **must** terminate outside the enclosed area. Extension beyond the enclosure will prevent lint and moisture buildup under the mobile home. See Figure 7.

### Mobile home installation

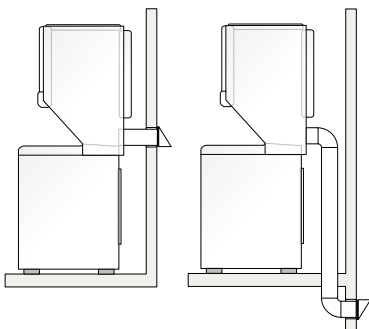

Figure 7

## Alternate electrical connection

Disconnect power supply cord from electric supply before making these changes.

Electrical ground is required on this appliance.

This appliance is manufactured **with** the neutral terminal connected to the frame.

**A.** If local codes permit the use of a flexible-type power supply cord (pigtail) and:

1. DO NOT permit connection of the frame grounding conductor to the neutral wire of the power supply cord:
  - a. Remove terminal block cover.
  - b. Remove the ground wire (green) from the green ground screw and fasten under center silver-colored terminal block screw. See Figure 8.

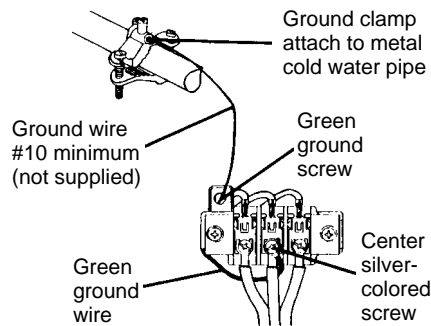

Ungrounded neutral  
Figure 8

Connect separate copper ground wire from green ground screw to approved ground.

- c. Connect a separate copper ground wire (No. 10 minimum) to a grounded cold water pipe\* by means of a clamp and then to the frame of the appliance at the green ground screw. Use Part No. 685463 ground wire and clamp assembly. Do not ground to a gas supply pipe. Do not connect the power supply cord to electric power supply until appliance is permanently grounded.
- d. Replace terminal block cover.

Figure 9

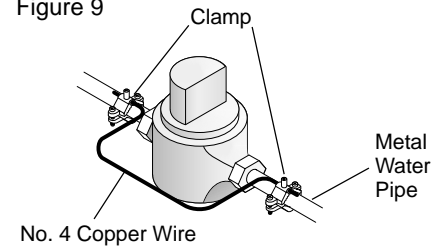

\*Grounded cold water pipe must have metal continuity to electrical ground and not be interrupted by plastic, rubber or other electrical insulating connectors (such as hoses, fittings, washers or gaskets, including water meter or pump). Any electrical insulating connector should be jumped as shown in Figure 9 with a length of No. 4 wire securely clamped to bare metal at both ends.

**B.** Local codes DO NOT permit the use of a power supply cord and:

1. Permit connection of the frame grounding conductor to the neutral wire of the power supply cord:
  - a. Remove the terminal block cover.

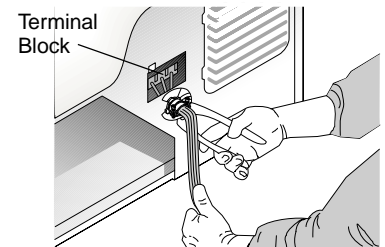

Figure 10

- b. Install U.L. approved strain relief (Figure 11) in one inch hole on dryer back below terminal block opening.

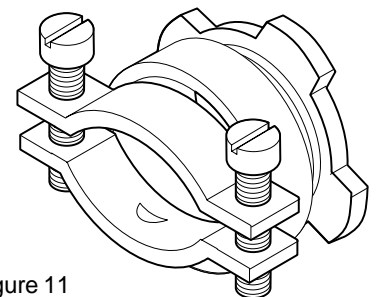
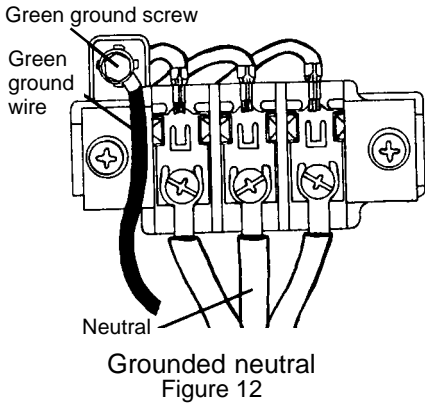

Figure 11

- c. Install copper power supply cable.

- d. Connect the neutral wire of the flexible armored or nonmetallic sheathed copper power supply cable to the center silver-colored terminal screw of the terminal block and connect the other wires to the outer terminals. See Figure 12. For connecting plain-end field wire, see Figure 15.
- e. Replace the terminal block cover.



Grounded neutral  
Figure 12

- 2. DO NOT permit connection of the frame grounding conductor to the neutral wire of the power supply cord:
  - a. Remove terminal block cover.
  - b. Install U.L. approved strain relief (Figure 11) in one inch hole on dryer back below terminal block opening.
  - c. Install copper power supply cable.
  - d. Remove the ground wire (green) from the green ground screw and fasten under center silver-colored terminal block screw.
  - e. Connect the neutral wire of the power supply cable to the center silver-colored terminal of the terminal block and connect the other wires to the outer terminals. See Figure 13. For connecting plain-end wire see Figure 15.

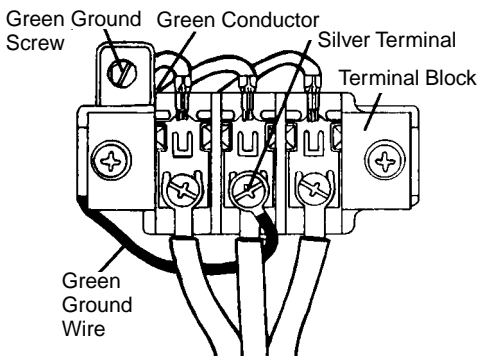

**Connect separate copper ground wire from external ground connector to approved ground.**

Ungrounded neutral  
Figure 13

- f. Connect a separate copper ground wire (No. 10 minimum) to a grounded cold water pipe\* by means of a clamp and then to the frame of the appliance at the green ground screw. Use Part No. 685463 ground wire and clamp assembly. Do not ground to a gas supply pipe. Do not connect the power supply cord to electric power supply until appliance is permanently grounded.
- g. Replace the terminal block cover.

\*Grounded cold water pipe must have metal continuity to electrical ground and not be interrupted by plastic, rubber or other electrical insulating connectors (such as hoses, fittings, washers or gaskets, including water meter or pump). Any electrical insulating connector should be jumped as shown in Figure 9 with a length of No. 4 wire securely clamped to bare metal at both ends.

### C. If connecting to a four-wire electrical system (mobile home):

1. Remove the terminal block cover.
2. Install U.L. approved strain relief (Figure 11) in one inch hole on dryer back below terminal block opening.
3. Install copper 4-wire power supply cord.
4. Remove the ground wire (green) from the green ground screw and fasten under center silver-colored terminal block screw.
5. Connect the ground wire (green) of the copper 4-wire power supply cord to the green ground screw.
6. Connect the neutral wire (white) of the power supply cord to the center silver-colored terminal screw of the terminal block and connect the other wires to the outer terminals. See Figure 14. For connecting plain-end field wiring, see Figure 15.
7. Replace the terminal block cover.

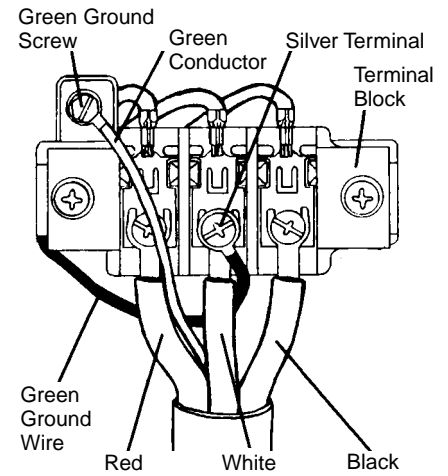

4-wire ungrounded neutral  
Figure 14

**IF YOUR POWER SUPPLY CORD OR DIRECT WIRING HAS PLAIN WIRE ENDS, SEE FIGURE 15 AND FOLLOW THESE STEPS:**

1. Strip outer covering back 3 inches from the end exposing the 3 wires.
2. Strip the insulation back 1 inch from the end of each wire. Form the bare wire into a U-shaped hook.
3. Loosen, do not remove, the center, silver-colored screw of the terminal block.
4. Slide the end of the neutral (white or center) wire under the screw head with the open side of the hook on the right. Squeeze the wire together to form a loop.
5. Tighten the screw firmly.
6. Connect the remaining 2 wires to the outer screws the same way. Tighten the screws firmly.

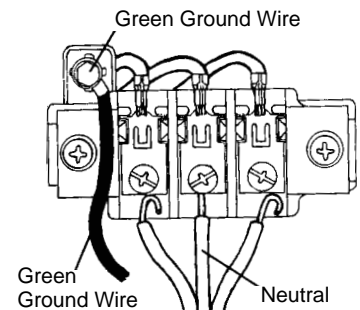
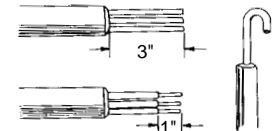

Plain-end field wiring  
Figure 15

**[Do not print**

## **Instructions for Page 8**

**Use existing negative of English Page 8 from 131531700 and delete the Brand Central Logo, power cord/plug stylistic artwork running horizontal across the upper page, and the Sears logo.**

**Hardcopy mockup is included with correspondence sent.**

**All else on this page remains as-is for the new 131639100 Page 8.]**