

---

---

# SERVICE DATA SHEET

**318200286 (0909) Rev. A**

Hybrid (Electric/Induction) Cooktop with Rotary Electronic Controls

---

---

## NOTICE

This service data sheet is intended for use by persons having electrical and mechanical training and a level of knowledge of these subjects generally considered acceptable in the appliance repair trade. **The manufacturer cannot be responsible, nor assume any liability, for injury or damage of any kind arising from the use of this data sheet.**

## SAFE SERVICING PRACTICES

To avoid the possibility of personal injury and/or property damage, it is important that safe servicing practices be observed. The following are some, but not all, examples of safe practices.

1. Do not attempt a product repair if you have any doubts as to your ability to complete it in a safe and satisfactory manner.
2. Before servicing or moving an appliance, remove power cord from electric outlet, trip circuit breaker to Off, or remove fuse.
3. Never interfere with the proper installation of any safety device.
4. USE ONLY REPLACEMENT PARTS SPECIFIED FOR THIS APPLIANCE. SUBSTITUTIONS MAY DEFEAT COMPLIANCE WITH SAFETY STANDARDS SET FOR HOME APPLIANCES.
5. GROUNDING: The standard color coding for safety ground wires is GREEN OR GREEN WITH YELLOW STRIPES. Ground leads are not to be used as current carrying conductors. IT IS EXTREMELY IMPORTANT THAT THE SERVICE TECHNICIAN REESTABLISH ALL SAFETY GROUNDS PRIOR TO COMPLETION OF SERVICE. FAILURE TO DO SO WILL CREATE A POTENTIAL HAZARD.
6. Prior to returning the product to service, ensure that:
  - All electric connections are correct and secure.
  - All electrical leads are properly dressed and secured away from sharp edges, high-temperature components, and moving parts.
  - All uninsulated electrical terminals, connectors, heaters, etc. are adequately spaced away from all metal parts and panels.
  - All safety grounds (both internal and external) are correctly and securely reassembled.
  - All panels are properly and securely reassembled.

## DATA SHEET ABBREVIATIONS AND TERMINOLOGY

ESEC : Electronic Surface Element Control

UIB : User Interface Board

RHIB : Rotary Human Interface Board

LED : Light-Emitting Diode

## HYBRID COOKTOP

The Cooktop is provided with 2 induction burners and 2 (for 30" model) or 3 (for 36" model) radiant burners. The ESEC (Electronic Surface Element Control) is designed to command the Relay Board that controls the radiant elements and the Induction Module that controls the induction coils.

The ESEC will control power of the different radiant elements based on the user selected levels. It will turn ON/OFF the elements according to power level requested by the user. The ESEC will maintain the elements temperature by cycling the Relay Board relays using a 40 seconds cycle, each power levels having a different duty cycle.

The ESEC will control power of the different induction burners based on the user selected levels. It will supply more or less heat to the cooking zone according to power level requested by the user. Induction zone heat is generated by magnetic field directly in the pot. This means no heat will be produced if there is no cookware on the zone or if the cookware is not suitable for induction cooking.

## CONTROL PANEL

30in Cooktop:

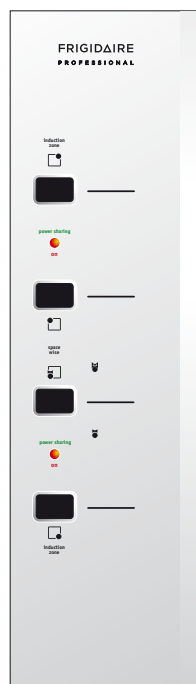

36in Cooktop:

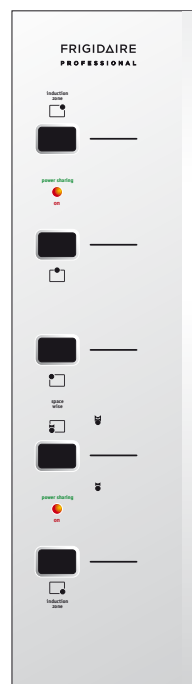

## ELECTRONIC CONTROLS

The electronic controls include the ESEC user interface board (UIB) to control the cooktop operation, input devices and display, the relay board to activate the different burners, the induction module that generate power to the inductors and the rotary board which hold the rotary input devices and the display.

Note: The ESEC UIB, Relay Board, Induction Module and Control are not field repairable.

Following sub assemblies of the cooktop can be replaced:

- ESEC User Interface Board
- Power Supply Board
- Relay/Control Board
- Rotary Board
- Pilot Lamps Assembly
- Wiring Harnesses
- Wiring Harness, Capacitor
- Heating Element
- Induction Module
- Inductors
- Fuse on Induction Module

## ESEC USER INTERFACE BOARD (UIB)

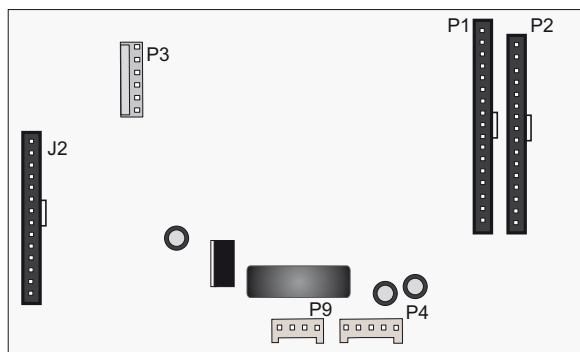

### UIB Board Legend

- P1.** Connector for Touch Panel LEDs and Display Indicators
- P2.** Connector for Touch Panel LEDs Display Indicators
- P3.** Micro-Programming Header (Not Used)
- P4.** Power Supply Input
- P9.** LIN Communication
- J2.** Rotary Control Signal Connector

## ROTARY HUMAN INTERFACE BOARDS

The rotary board is equipped with one rotary control for each cooking zones. There are 2 different rotary board for each cooktop size. The 30" cooktop rotary board is a depopulated version of the 36" cooktop board. Below is the display/controls assignment for each model.

### 30" Cooktop:

Right Rear rotary control and display

Left Rear rotary control and display

Left Front and Bridge rotary control and display

Right Front rotary control and display

Not Populated

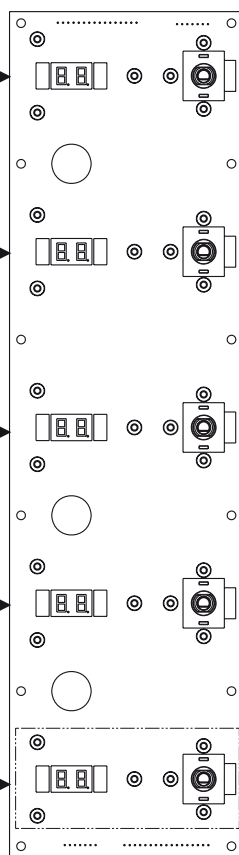

### 36" Cooktop:

Right Rear rotary control and display

Center Rear rotary control and display

Left Rear rotary control and display

Left Front and Bridge rotary control and display

Right Front rotary control and display

## PILOT LAMPS



## INDUCTION MODULE

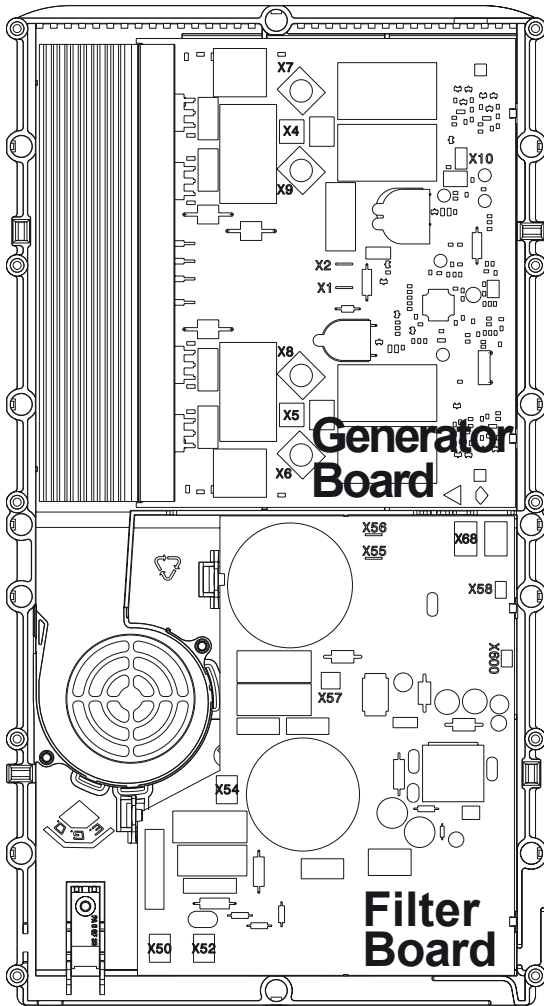

### Induction Module Legend:

- X5/X6/X8. Right Front Element
- X4/X7/X9. Right Rear Element
- X50/L1. L1 Line Voltage Input
- X52/N1. L2 Line Voltage Input
- X54/GND. Ground Line Voltage Input
- X68. Communication with UIB and Relay Board

## RELAY BOARD

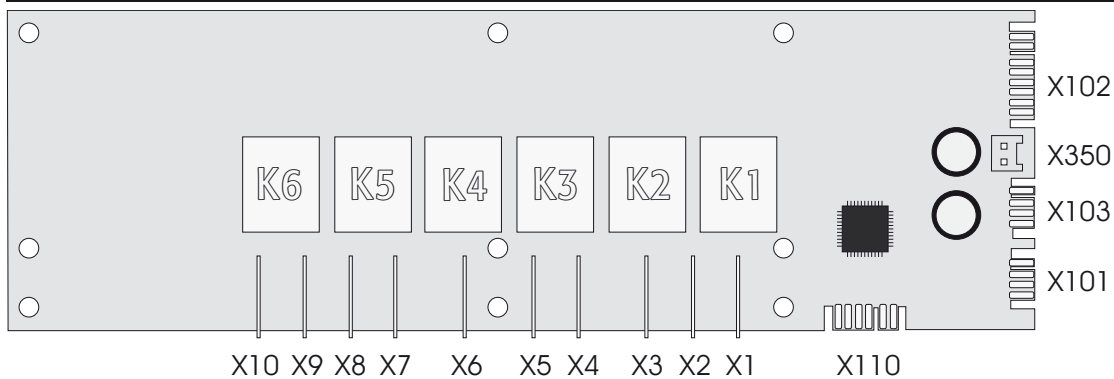

### Relay Board Legend:

- |   |   |
|---|---|
| <ul style="list-style-type: none"> <li>X1. Left Rear Element</li> <li>X2. L2 Line Voltage Input</li> <li>X3. Not Used</li> <li>X4. L2 Line Voltage Input</li> <li>X5. Left Front Element</li> <li>X6. Bridge Element</li> <li>X7. L2 Line Voltage Input</li> <li>X8. Center Rear Element (only 36" model)</li> <li>X9. Not Used</li> <li>X10. Not Used</li> </ul> | <ul style="list-style-type: none"> <li>X101/103. Communication with UIB and Induction Module (could be either X101 and X103)</li> <li>X102. Surface Element Hot Signal Inputs</li> <li>X110. Micro Programming header (not used)</li> <li>X350. Thermostats Signal Inputs (Shorted)</li> <li>K1. Relay for Left Rear Element</li> <li>K2. Not Used</li> <li>K3. Relay for Left Front Element</li> <li>K4. Relay for Bridge Element</li> <li>K5. Relay for Center Rear Element (36" only)</li> <li>K6. Not Used</li> </ul> |
|---|---|

## POWER SUPPLY BOARD

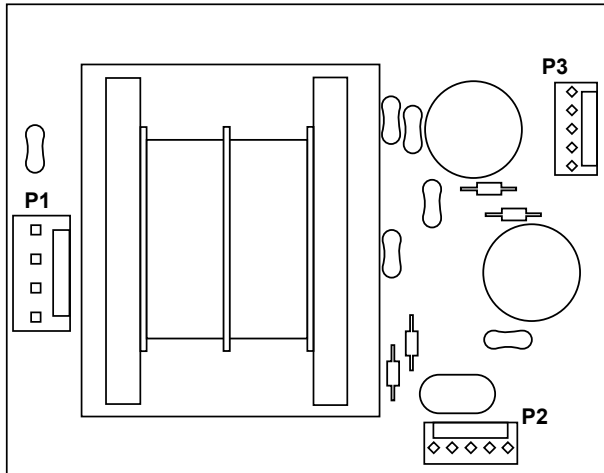

### Power Supply Board Legend:

P1. AC Input Voltage (120VAC)

P2. Not Used

P3. DC Outputs

## WIRE HARNESS CAPACITOR (some models)

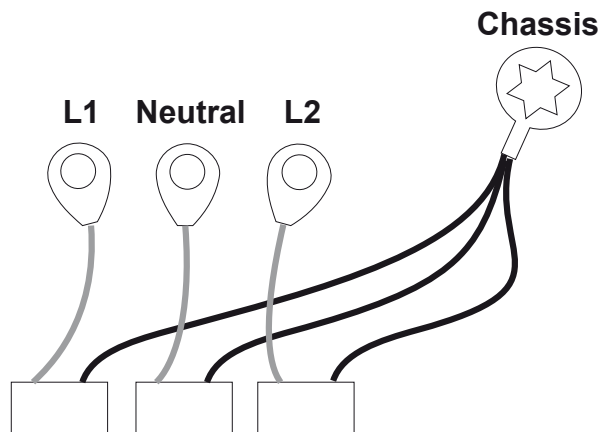

## ELECTRICAL RATING

### 30" Model :

- Left Rear	Radiant Single Element 7"	1800W
- Left Front	Radiant Bridge Element 7"	1800W / 2600W
- Right Rear	Induction 145mm	1500W / Power Boost 1900W
- Right Front	Induction 260mm	2500W / Power Boost 3400W

### 36" Model :

- Left Rear	Radiant Single Element 7"	1800W
- Left Front	Radiant Bridge Element 7"	1800W / 2600W
- Center Rear	Radiant Single Element 6"	1200W
- Right Rear	Induction 145mm	1500W / Power Boost 1900W
- Right Front	Induction 260mm	2500W / Power Boost 3400W

## ERROR CODES

Error #	36"	30"	Condition	Suggested Corrective Action
14	14	14	UI Panel cable missing	1) Verify all cables between Rotary Boards & ESEC20 UIB are well connected && not damaged. 2) Verify cable between Rotary Board && Pilot Lamps is connected && not damage. 3) Change ESEC20 UIB) 4) Change Rotary Board
21	21	21	Touch: Lin error - no communications	1) Verify communication harnesses between ESEC20 UIB, Induction Generator Housing && Relay Board are well connected && not damaged. 2) Change ESEC20 UIB. 3) Change Relay Board. 4) Replace the Induction Generator Housing.
32	32	32	12V on the service section to low (relay board)	1) Verify harness between Induction Generator Housing && Relay Board. 2) Change the Relay Board. 4) Replace the Induction Generator Housing.
36	36	36	LIN error, bad communication.	1) Verify LIN communication cable is well connected && not damaged. 2) Replace relay board.
37	37	37	Relay Voltage Error" and indicates that the number of relays switched on is wrong	1) Replace relay board.
38	38	38	General HW/SW error, relay board	1) Replace relay board.
39	39	39	Incorrect configuration, ESEC20 vs Induction Generator Housing or Relay Board.	Execute following sequence to force cooktop reconfiguration (Be sure the good ESEC20 UIB is installed into the cooktop)
				1-Put all rotary control to the first detent position clockwise (10 o'clock).
				2-Put all rotary control to the first detent position counterclockwise (8 o'clock). The system should then reconfigure, showing walking dashes on the cooking zones displays.
				3-Put all rotary controls to "Off" position. There should be no more error code and the cooktop is ready for operation.
			4-Test all zones for correct operation.	
51	51	51	Element temperature sensor break, (Relay Board)	1) Check jumper wire harness at X350 of relay board. Replace if defective. 2) Change Relay Board.
54	54	54	Element temperature sensor break, cook place 4 (Rear Right)	1) Verify element temperature sensor is correctly connected to the induction housing. 2) Replace element if the temperature sensor resistor value is not approximatively 1000 ohms at room temperature. 3) Replace the Induction Generator Housing
55	55	55	Element temperature sensor break, cook place 5 (Front Right)	
61	61	61	Heat sink temperature sensor break on Relay Board	1) Verify cooktop ventilation is correct(airway & fan) 2) Verify if the cooktop is correctly re-assembled && installed. 3) Change the Relay Board.
64	64	64	Element temperature sensor too hot cook place 4 (Rear Right)	1) Verify cooktop ventilation is correct(airway & fan). 2) Verify if the cooktop is correctly re-assembled && installed. 3) Verify element temperature sensor is correctly connected to the induction housing. 4) Replace element if the temperature sensor resistor value is not approximatively 1000 ohms at room temperature. 5) Replace the Induction Generator Housing.
65	65	65	Element temperature sensor too hot cook place 5 (Front Right)	
80	80	80	General HW/SW error, Induction Generator Assy	1) Replace Induction Generator Housing
81	81	81	General HW/SW error, relay board	1) Replace relay board.
90	90	90	Wrong connection secondary voltage of the power pack too high (primary > 300V)	1) Verify AC input voltage at the cooktop input. 2) Verify AC main input cables & screws 3) Replace the Filter Board on the Induction Generator Housing
91	91	91	Synchronous impulse (net zero crossover)	1) Test cables & connections on the Induction Generator Housing. 2) Replace the Induction Generator Housing
92	92	92	12V on the service section to low (Induction Generator Housing)	1) Test cables & connections on the Induction Generator Housing. 2) Replace the Induction Generator Housing
93	93	93	5V overcurrent on the switched 5V on the service section	
94	94	94	Sub LIN error communication filter service section incorrectly - This is an error detected between the filter board and the power boards.	1) Verify cable between filter board X58 and generator board X10. 2) Verify the thermal limiter resistor value (installed in the heat sink) to be approximatively 0 ohm. 3) Replace the Induction Generator Housing.
95	95	95	Mains voltage signal invalidly phase 1, undervoltage or optocoupler defective - This is an indication that one phase is wrong. The other phase will still work.	1) Verify AC input voltage at the cooktop input. 2) Verify AC main input cables & screws 3) Verify the fuse resistance to be approximatively 0 ohm. 4) Replace the Induction Generator Housing
96	96	96	LIN error, bad communication.	1) Replace the Induction Generator Housing
97	97	97	Heat sink temperature sensor break	1) Replace the Induction Generator Housing
98	98	98	General HW/SW error, Induction Generator Assy	1) Replace the Induction Generator Housing

# INTERCONNECTION DIAGRAM

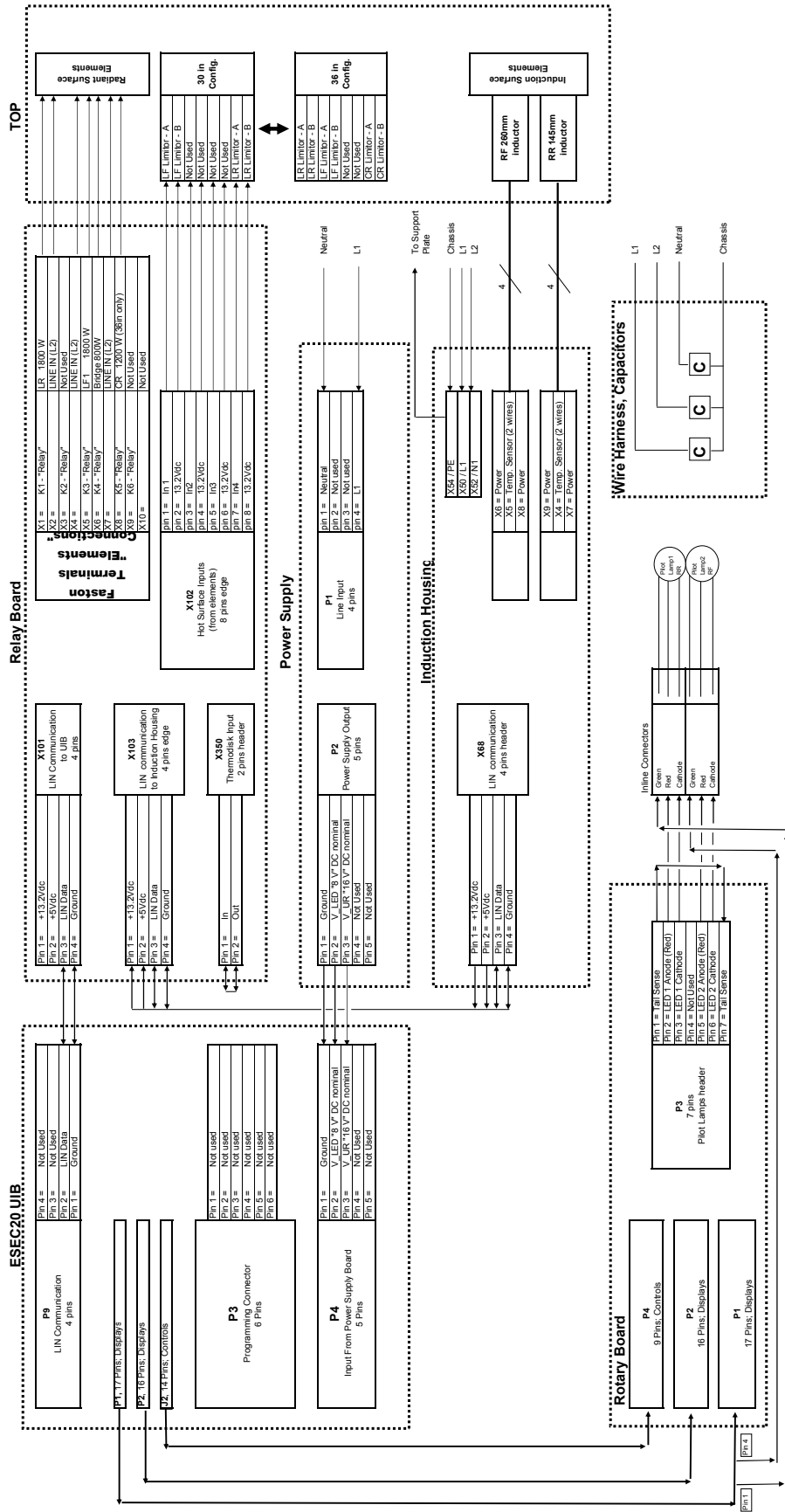

## NOTES