

# Installation Instructions

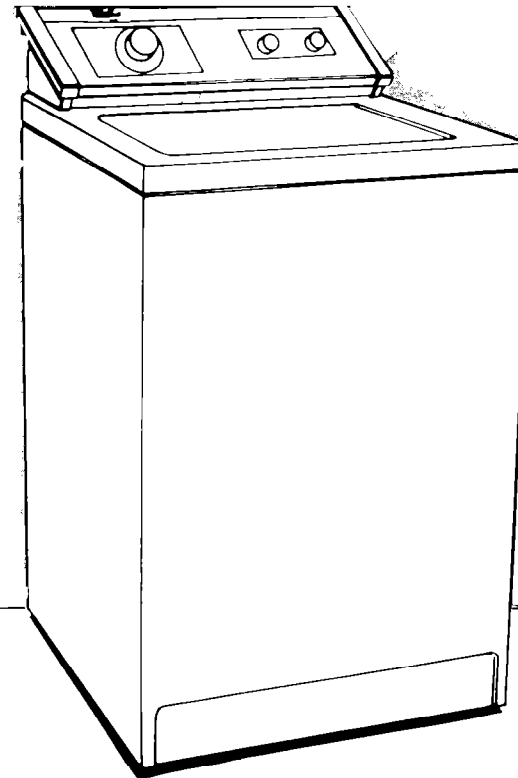

Part No. 3353853

**Washer**

**220 Volt  
60 Hz.**

12/93

**IMPORTANT**

**Installer:** Leave Installation Instructions with the homeowner.

**Homeowner:** Keep Installation Instructions for future reference.

**Save** Installation Instructions for local electrical inspector's use.



## Before you start...

Check location where washer will be installed. Proper installation is your responsibility. Make sure you have everything necessary for correct installation.

**Grounded electrical outlet** is required. See Electrical requirements.

**Standpipe drain system:** needs a two-inch minimum diameter standpipe with minimum carry-away capacity of 17 gallons (64 liters) per minute. Top of standpipe must be at least 34 inches (86 centimeters) high and no higher than 72 inches (183 centimeters) from bottom of washer.

**Floor drain system:** requires a siphon break, Part No. 285320.

Untape and open washer lid. Remove packages, hoses and literature rack from washer.

**Hot and cold water faucets:** must be within 4 feet (122 centimeters) of the back of the washer and provide water pressure 5-100 PSI (34.5-689.6 KPa).

**Laundry tub drain system:** needs a 20-gallon (76 liter) laundry tub. Top of tub must be at least 34 inches (86 centimeters) high and no higher than 72 inches (183 centimeters) from bottom of washer.

If a longer drain hose is needed, drain hose, Part No. 388423, and hose extension kit, Part No. 285442, are available from Whirlpool-authorized parts distributors.

**Important: observe all governing codes and ordinances.**

**Water heater:** set to deliver 140°F (60°C) water to the washer.

**SEE RECESSED AREA INSTRUCTIONS ON BACK COVER.**

**Level floor:** maximum slope under washer, 1 inch (2.5 centimeters).

**Support:** floor must be sturdy enough to support washer weight of 315 pounds (143 kg).

## CAUTION:

### Product Damage

Do Not store or operate washer below 32°F (0°C) (some water may remain in washer). See Use & Care Guide for "Winterizing" information. Failure to follow above may result in product damage.

## Tools needed for installation:

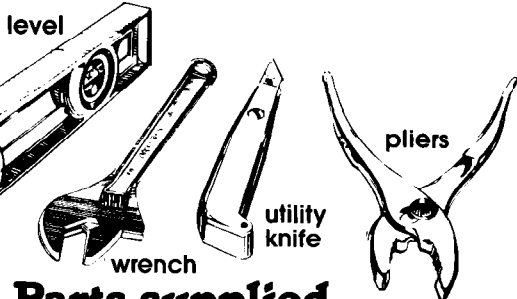

## Parts supplied for installation:

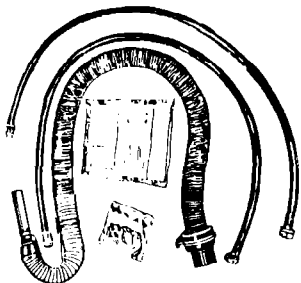

Remove parts from packages. Check that all parts were included.

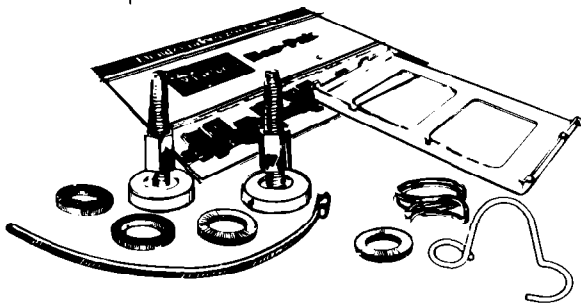

1 wire form literature package  
1 drain hose  
1 plastic strap  
1 hose clamp  
2 inlet hoses

4 flat water hose washers  
1 literature rack (not supplied with all models)  
2 front leveling legs with nuts

## Electrical requirements

220-Volt, 60-Hz, AC only, 15-or 20-Ampere fused electrical supply is required. Time-delay fuse or circuit breaker is recommended. It is recommended that a separate circuit serving only this appliance be provided.

## Recommended grounding method

### WARNING:

#### Electrical Shock Hazard

- Electrical ground is required on this product.
- Improper connection of the equipment-grounding conductor can result in electrical shock.
- Check with a qualified electrician if you are in doubt as to whether the appliance is properly grounded.
- Do Not modify the power supply cord plug. If it will not fit the outlet, have a proper outlet installed by a qualified electrician. Modifying the power supply cord plug could result in electrical shock.
- Do Not use an extension cord with this appliance. Such use could result in a fire, electrical shock or other personal injury.
- Do Not have a fuse in the neutral or grounding circuit. This could result in electrical shock.

Do Not, under any circumstances, remove the power supply cord grounding prong.

For your personal safety, this appliance must be grounded. This appliance is equipped with a power supply cord. To minimize possible shock hazard, the cord must be plugged into a mating grounding-type wall receptacle, grounded in accordance with local codes and ordinances. See Figure 1. If a mating wall receptacle is not available, it is the personal responsibility and obligation of the customer to have a properly grounded wall receptacle installed by a qualified electrician.

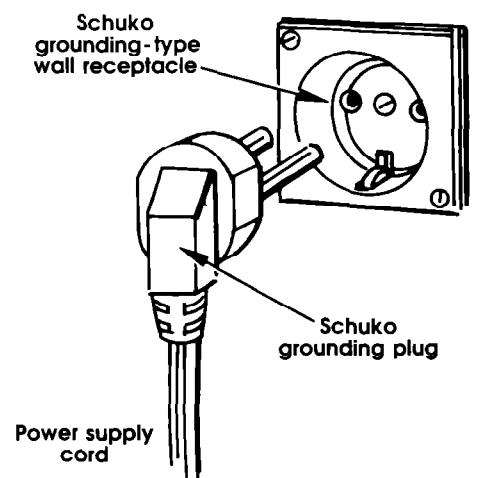
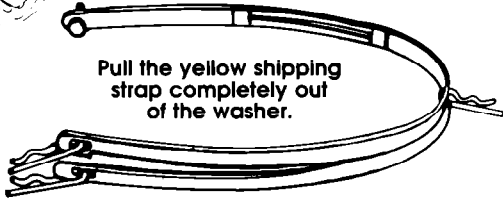
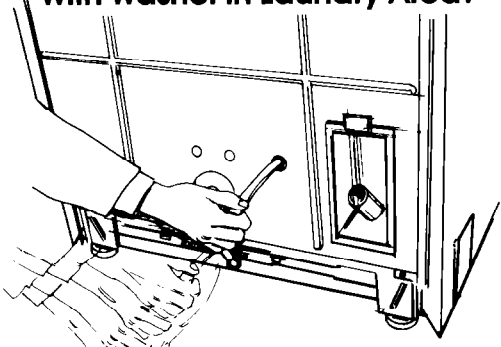

Figure 1

# Now Start...

With Washer in Laundry Area.



Pull the yellow shipping strap completely out of the washer.

**1.** Remove tape that covers shipping strap. Pull to completely remove the yellow shipping strap from the inside of the washer. Read, then remove label that covers power cord and drain connector.

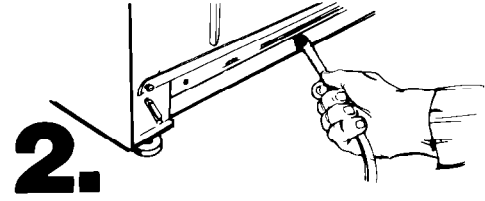

**2.** Pull firmly to remove the other end of the yellow shipping strap from the back of the washer. The shipping strap plug must be completely removed from the washer for the self-leveling legs to be released. **Use new hoses and washers that came with your Whirlpool washer.**

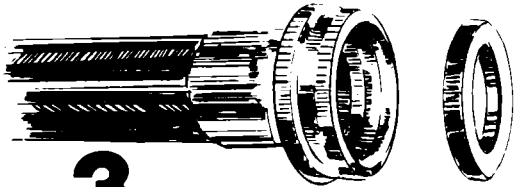

**3.** coupling washer

Insert a flat washer into **each** end of the inlet hoses. Check that washers are firmly seated in couplings.

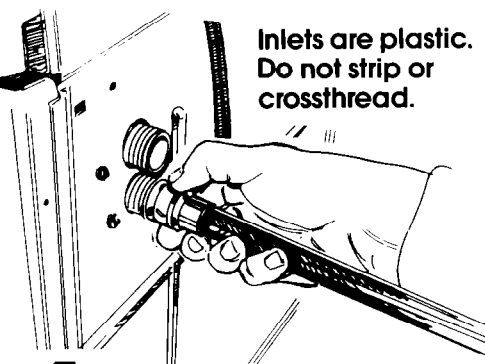

Inlets are plastic. Do not strip or crossthread.

**4.** Attach hose to bottom inlet valve opening first; then second hose to top inlet. Tighten couplings by hand. Then use pliers to make an additional two-thirds turn.

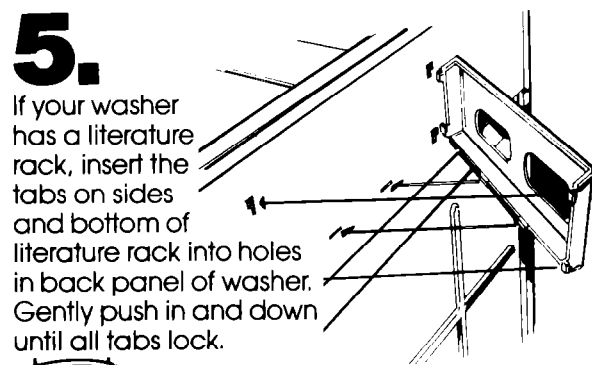

If your washer has a literature rack, insert the tabs on sides and bottom of literature rack into holes in back panel of washer. Gently push in and down until all tabs lock.

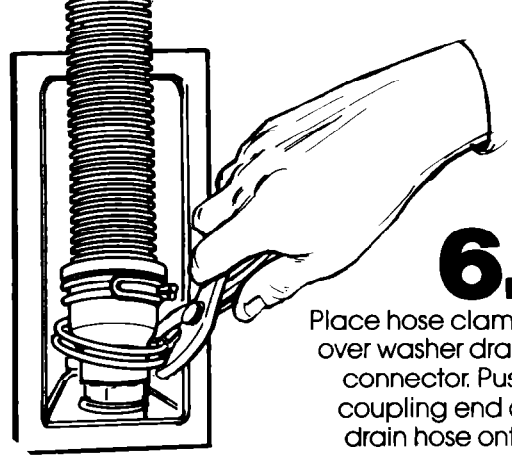

**6.**

Place hose clamp over washer drain connector. Push coupling end of drain hose onto washer connector. Use pliers to open clamp and slide clamp over drain hose. Check for good fit.

Numbers correspond to steps.

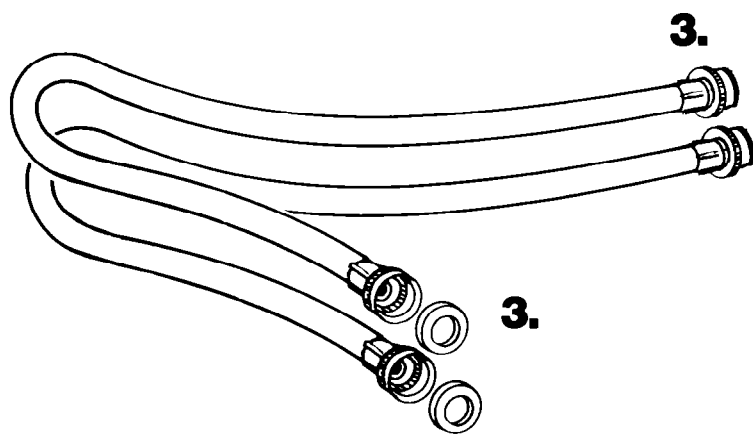

**18.**

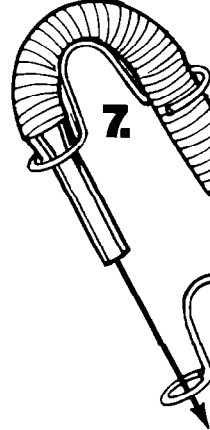

**7.** Slide nozzle end of drain hose through the **small "loop"** in the wire form. Wrap the hook end of the wire form around the drain hose to form a "hook shape."

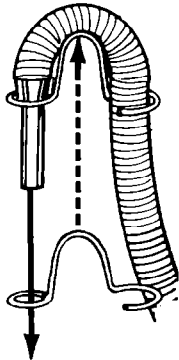

## CAUTION:

**Floor Damage**  
Slide washer onto cardboard or hardboard before moving across floor. Failure to do so may cause damage to floor covering.

**8.** Move washer close to final position. Put "hook" end of drain hose into laundry tub or standpipe. Check for proper length of drain hose.

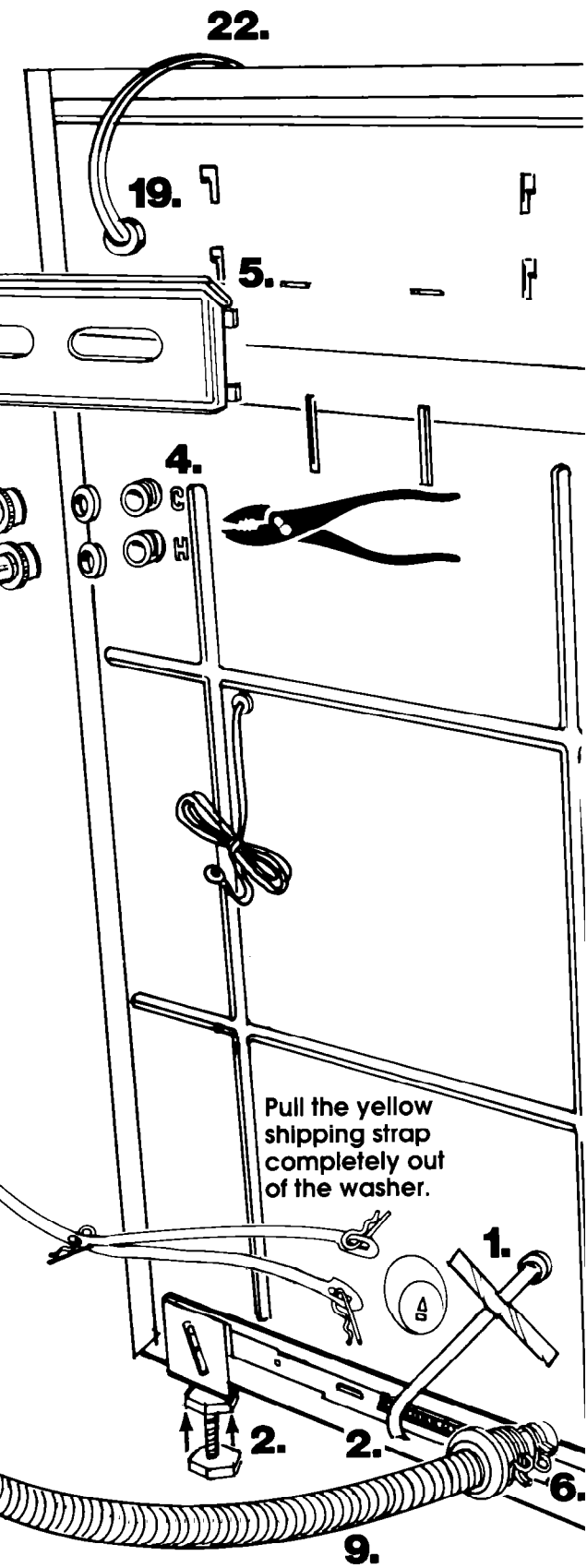
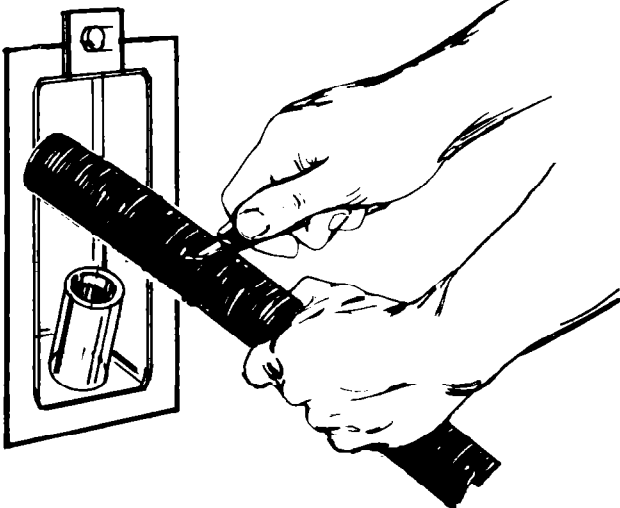

**9.** If drain hose is too long – disconnect. Remove clamp and coupling. Estimate length of drain hose needed. Cut flexible end of hose. **(Do not cut hook-shaped end of drain hose.)** Push and twist coupling securely onto drain hose. (You should feel top of hose through coupling.) Slide clamp over coupling and hose. Reinstall drain hose. See Step 6.

**DO NOT FORCE EXCESS LENGTH OF DRAIN HOSE DOWN THE STANDPIPE. THIS COULD CAUSE SIPHONING.**



**10.** Before attaching water inlet hoses, run water through both faucets into a bucket to get rid of particles in water lines.

**11.** Attach bottom hose (inlet marked "H") to hot water faucet. Attach top hose (inlet marked "C") to cold water faucet. Tighten coupling to faucet by hand, then use pliers to make final two-thirds turn.

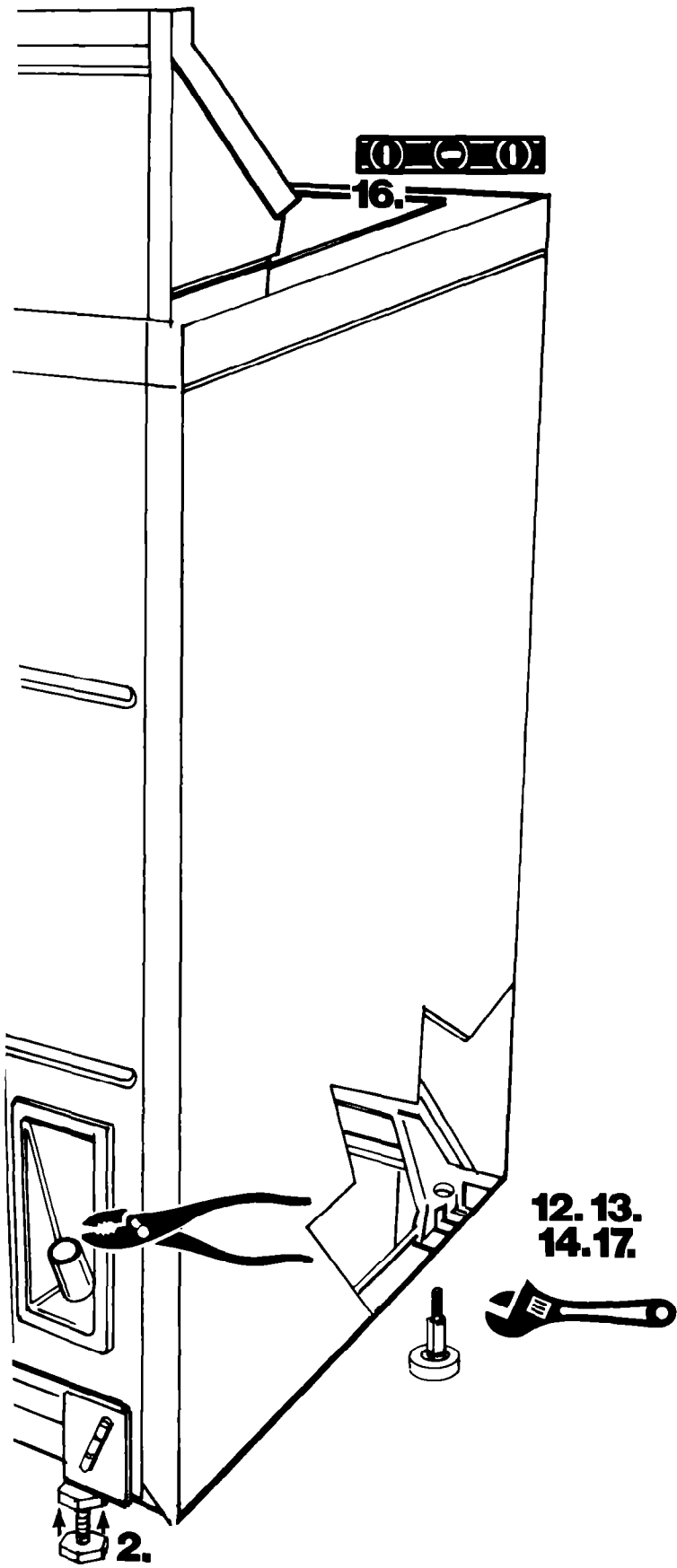

## 15.

Tilt washer backward and remove corner post(s). Gently lower washer to floor.

**Move washer to its permanent location.**

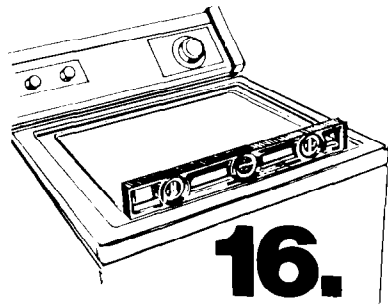

Tilt washer forward raising back legs 1" (2.54 cm) off of floor to adjust self-leveling legs. Gently lower washer to floor. Check levelness at the washer front and from front to back on each side using a carpenter's level.

## 17.

If washer is not level, screw the front legs up or down to adjust. Make final check with level.

**When washer is level, use wrench to turn nuts on front legs up tightly against washer base. If nuts are not tight against washer base, the washer may vibrate.**

## 18.

Put "hook" end of drain hose in tub or standpipe. Secure drain hose by wrapping the plastic strap around the hose as shown in Figures A-C. If drain hose cannot be strapped in place, it must be cut exactly to length so the "hook" end is held tightly over the edge of the tub or standpipe as shown in Figure D.

**Note: If washer is moved to adjust drain hose, the washer must be leveled again. Repeat Steps 16-17. Place cardboard under washer and carefully move washer to avoid damaging floor covering.**

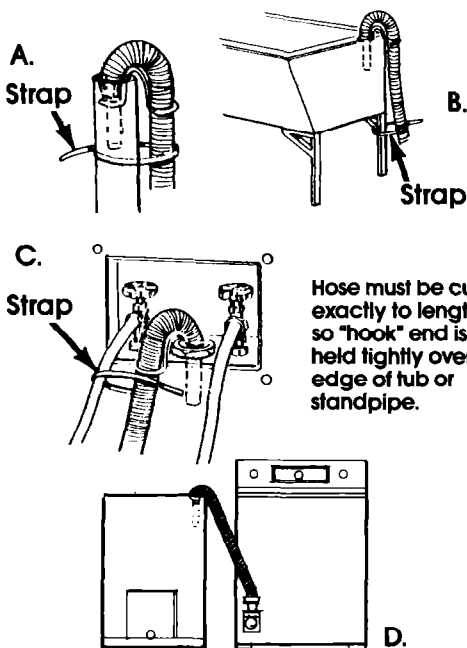

**CHECK THAT HOSE IS NOT TWISTED OR KINKED AND IS SECURELY IN PLACE.**

## 19.

**CHECK ELECTRICAL REQUIREMENTS. BE SURE YOU HAVE CORRECT ELECTRICAL SUPPLY AND RECEPTACLE.**

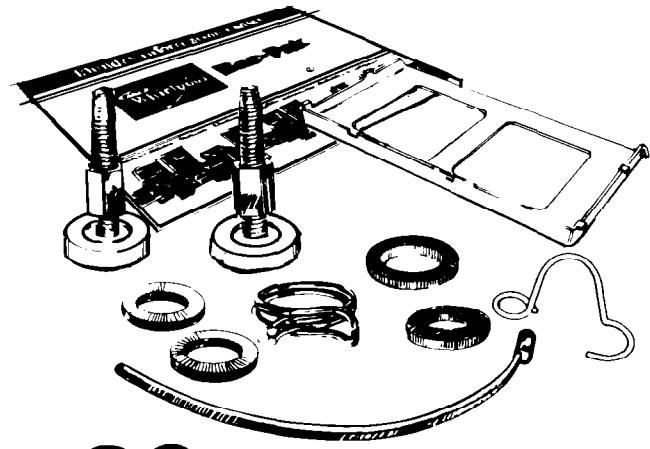

## 20.

Check that all parts are now installed. See parts list, Panel A. If there is an extra part, go back through steps to see which step was skipped.

## 21.

Turn on water faucets and check for leaks. Tighten couplings if there is leaking.

## 22.

Remove electrical cord from basket and plug into grounded outlet.

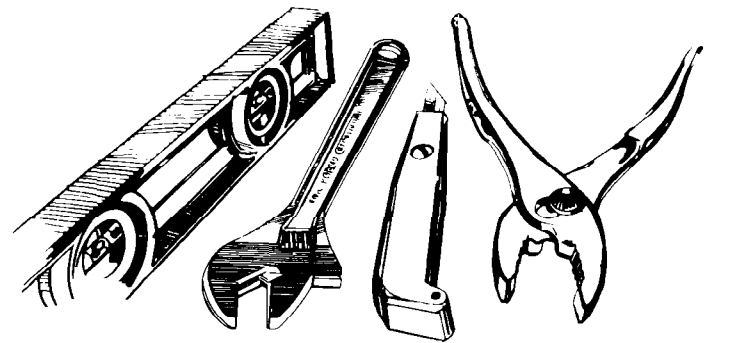

## 23.

Check that you have all tools that you started with and that the yellow shipping strap with its 3 cotterpins and plug was removed from the washer.

## 24.

Take a few minutes and read the Use and Care Guide to fully understand your new washer. Now start the washer and allow it to complete the regular cycle. Put literature in the Literature Rack. (Literature Rack not supplied with all models.)

## 12.

Carefully tilt washer backward until front of washer is 3-4 inches (7-10 cm) off of floor. Insert 1 or 2 corner posts.

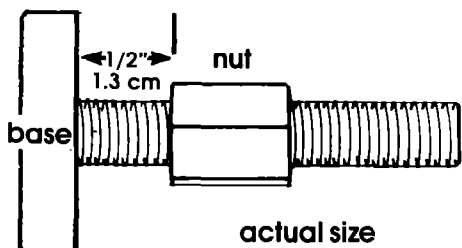

## 13.

Use legs and nuts from parts package. Screw nut down to within 1/2" (1.3 cm) of base.



## 14.

Insert legs into correct holes at each front corner of washer until nuts touch washer. **Do not** tighten nuts until step 17.

You have successfully installed your new Whirlpool washer. To get the most efficient use from your new washer, read your Whirlpool Use and Care Guide. **Congratulations!**

Keep Installation Instructions and Guide. The instructions will make reinstalling your Whirlpool washer in another home as easy as the first installation.

## Recessed area instructions.

This washer may be installed in a recessed area or closet.

The installation spacing is minimum allowable. Additional spacing should be considered for ease of installation and servicing.

If closet door is installed, the minimum air openings in top and bottom are required. Louvered doors with air openings in top and bottom are acceptable.

Companion appliance spacing should be considered.

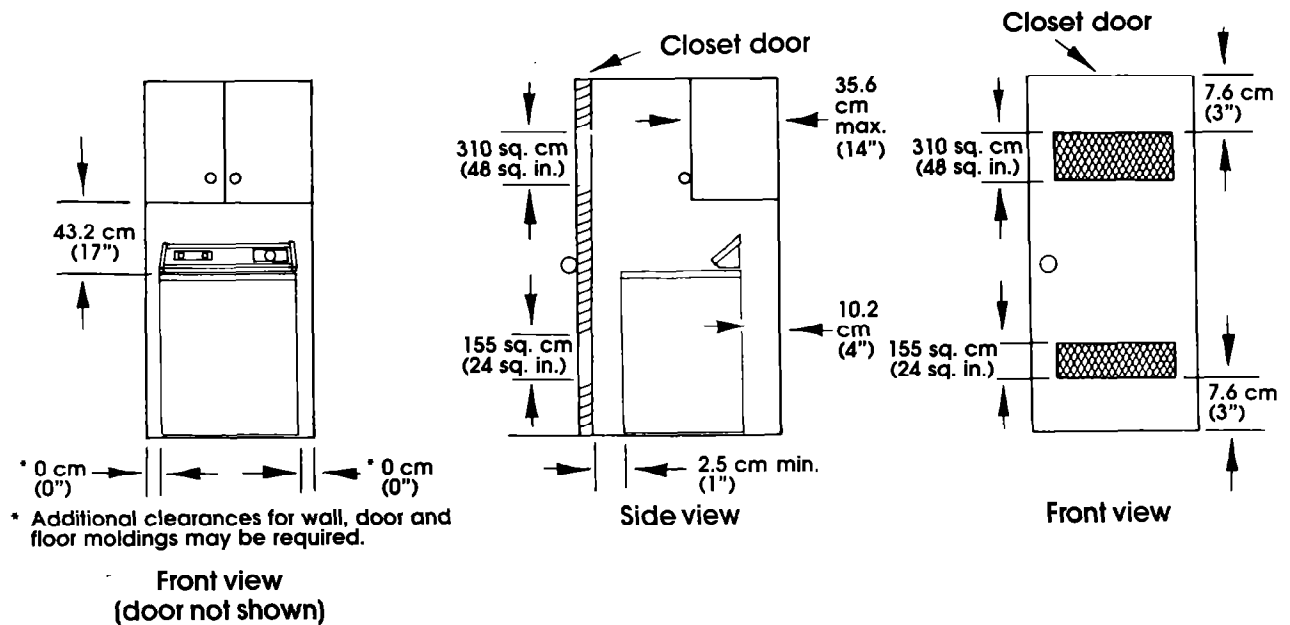

Minimum installation spacing

