

Installation Instructions

30" Sealed Gas Cooktop

JGP328, JGP330, JGP933,
JGP940, JGP945

 Questions? Call 800.GE.CARES (800.432.2737) or Visit our Website at: www.GEAppliances.com
In Canada, call 1.800.361.3400 or Visit our Website at: www.geappliances.ca

IN THE COMMONWEALTH OF MASSACHUSETTS:

- This product must be installed by a licensed plumber or gas fitter.
- When using ball-type gas shut-off valves, they shall be the T-handle type.
- A flexible gas connector, when used, must not exceed 3 feet.

BEFORE YOU BEGIN

Read these instructions completely and carefully.

- **IMPORTANT** — Save these instructions for local inspector's use.
- **IMPORTANT** — Observe all governing codes and ordinances.
- **Note to Installer** – Be sure to leave these instructions with the Consumer.
- **Note to Consumer** – Keep these instructions for future reference.
- Product failure due to improper installation is not covered under the Warranty.

▲WARNING — This appliance must be properly grounded.

- **IMPORTANT** — Leak testing of the appliance shall be conducted according to the manufacturer's instructions.
- **Proper installation is the responsibility of the installer and product failure due to improper installation is NOT covered under warranty.**

▲WARNING — Disconnect all electrical power at the main circuit breaker or fuse box before installing.

FOR YOUR SAFETY:

▲WARNING — If the information in this manual is not followed exactly, a fire, explosion or gas leak may result causing property damage, personal injury or death.

Do not store or use gasoline or other flammable vapors and liquids in the vicinity of this or any other appliance!



WHAT TO DO IF YOU SMELL GAS:

- Do not try to light any appliance. Do not touch any electrical switch; do not use any phone in your building.
- Immediately call your gas supplier from a neighbor's phone. Follow the gas supplier's instructions.
- If you cannot reach your gas supplier, call the fire department.

Installation and service must be performed by a qualified installer, service agency or the gas supplier.

This cooktop has been design certified by CSA International. You'll find safety precautions in your Owner's Manual. Read them carefully.

- Installation of this cooktop must conform with local codes or in the absence of local codes with the National Fuel Gas Code, ANSI Z223.1/NFPA 54—Latest edition.
- Be sure your cooktop is installed properly by a qualified installer or service technician.
- To eliminate reaching over surface burners, cabinet storage above burner should be avoided.
- Do not install the unit near an outside door or where a draft may affect its use.

Installation Instructions

IMPORTANT SAFETY INSTRUCTIONS

ELECTRICAL REQUIREMENTS

This appliance must be supplied with the proper voltage and frequency and connected to an individual, properly grounded branch circuit, protected by a circuit breaker or fuse having amperage as noted on the rating plate.

We recommend you have the electrical wiring and hookup of your cooktop connected by a qualified electrician. After installation, have the electrician show you where your main cooktop disconnect is located.

Check with your local utilities for electrical codes which apply in your area. Failure to wire your cooktop according to governing codes could result in a hazardous condition. If there are no codes, your cooktop must be wired and fused to meet the requirements of the National Electrical Code, ANSI/NFPA No. 70—Latest edition. You can get a copy by writing:

National Fire Protection Association
Batterymarch Park
Quincy, MA 02269

In Canada your cooktop must be wired and fused to meet the requirements of the Canadian Electrical Code.

Be sure the installation of this product in a mobile home conforms with the Manufactured Home Construction and Safety Standard, Title 24 CFR, Part 3280. If this standard does not apply, you must follow the standard for Manufactured Home Installations, Sites and Communities and ANSI/NFPA 501A or with local codes. You can get a copy of the Federal Standard by Writing:

Office of Mobile Home Standards
HUD Building
451 7th Street, S.W.
Washington, D.C. 24010

PARTS INCLUDED



2 Screws

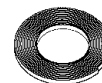

Foam Tape

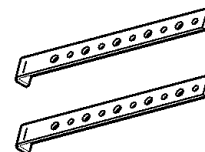

2 Hold
Down Brackets

MATERIALS YOU MAY NEED



Joint Sealant

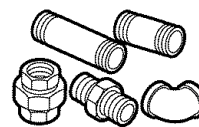

Pipe Fittings

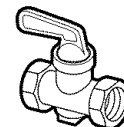

Shut Off Valve



CSA-Approved Flexible Gas Line
3/8" Min. ID, 1/2" NPT Connection,
3-foot Maximum Length (Massachusetts Only)

TOOLS YOU WILL NEED FOR INSTALLATION



Pencil



Saber Saw



Phillips Head
Screwdriver

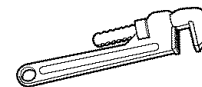

Pipe Wrench

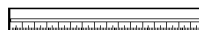

Ruler or Straightedge

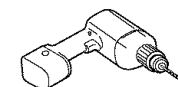

1/8" Drill Bit & Electric
or Hand Drill



Safety Glasses

Installation Instructions

PRE-INSTALLATION CHECKLIST

A When preparing cooktop opening, make sure the inside of the cabinet and the cooktop do not interfere with each other. (See section on preparing the opening.)

B Remove packaging materials, grate boxes, regulator with literature, and literature package from the cooktop before beginning installation.

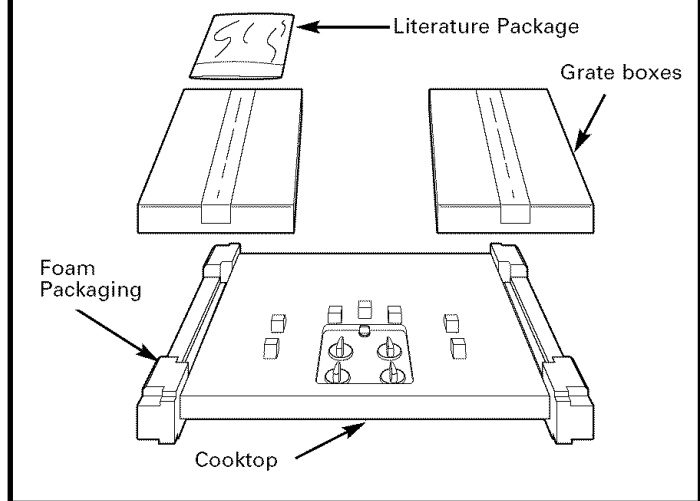

C Remove Installation Instructions from literature pack and read them carefully before you begin.

Be sure to place all literature, Use and Care, Installations, etc. in a safe place for future reference.



D Make sure you have all the tools and materials you need before starting the installation of the cooktop.

E Your home must provide the adequate electrical service needed to safely and properly use your cooktop. (Refer to section on electrical requirements.)

F When installing your cooktop in your home, make sure all local codes and ordinances are followed exactly as stated.

G Make sure the wall coverings, countertop and cabinets around the cooktop can withstand heat (up to 200°F) generated by the cooktop.

Installation Instructions

PREPARING THE OPENING

1 MAINTAIN THE FOLLOWING MINIMUM CLEARANCE DIMENSIONS

13" MAX. Depth of unprotected overhead cabinets

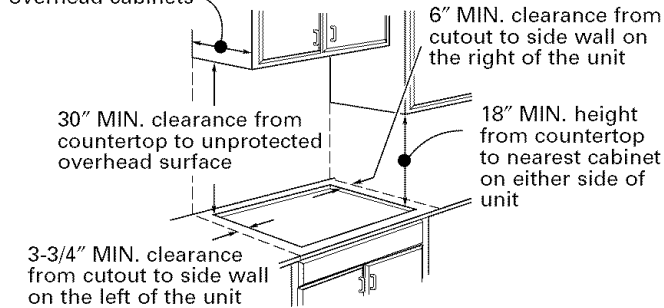

2 OVERALL COOKTOP DIMENSIONS

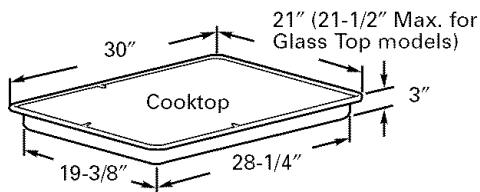

3 CUTOUT DIMENSIONS OF COUNTERTOP

To ensure accuracy, it is best to make a template when cutting the opening in the counter.

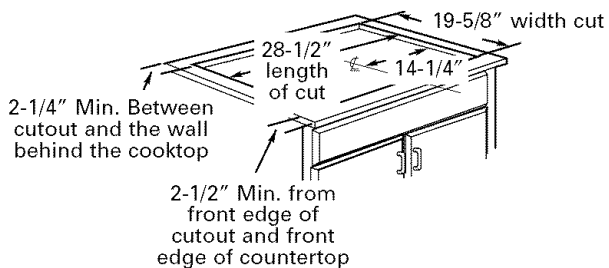

4 RECOMMENDED GAS SUPPLY LOCATION FROM BACKWALL

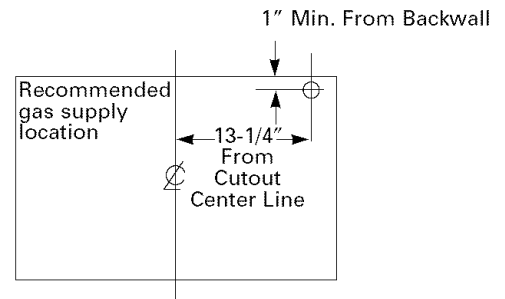

5 MAKE SURE WALL COVERINGS, COUNTERTOP AND CABINETS AROUND COOKTOP CAN WITHSTAND HEAT (UP TO 200°F) GENERATED BY COOKTOP

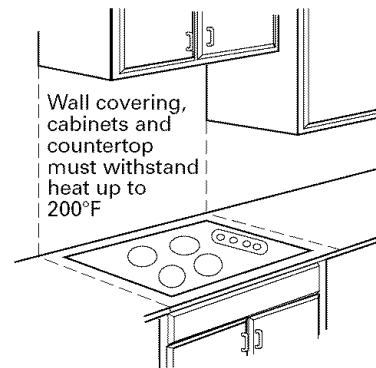

Installation Instructions

INSTALLING THE COOKTOP UNIT

1 LOCATE ELECTRICAL OUTLET AND GAS SHUT-OFF VALVE BENEATH CABINET

NEVER REUSE OLD CONNECTORS WHEN INSTALLING THIS UNIT.

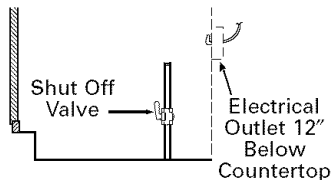

Install a manual shut-off valve in the gas line in an easily accessible location outside the cooktop. Be sure you know how and where to shut off the gas supply to the cooktop. Install the electrical outlet 12" below the countertop.

2 PROTECT SURFACE OF COOKTOP

Place a towel or tablecloth onto the countertop. Lay the cooktop upside down onto the protected surface.

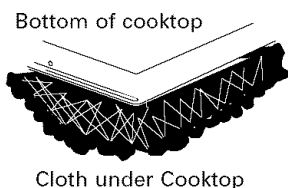

3 ATTACH FOAM TAPE

(glass maintop models only)

Apply the foam tape around the outer edge of the glass. **Do not overlap the foam strips.**

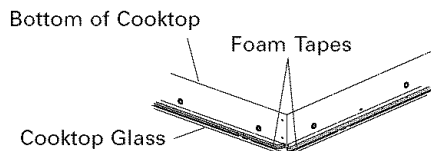

4 LOCATE MOUNTING PARTS

Remove the hold down brackets from the literature package.

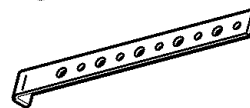

5 ATTACH BRACKETS TO COOKTOP

Remove the screw from the side of the cooktop and screw the hold-down bracket to the side of the cooktop unit. Repeat for opposite side of cooktop.

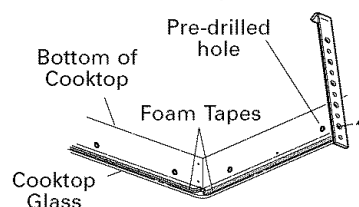

6 INSERT COOKTOP INTO CUTOUT

Insert the cooktop centered into the cutout opening. Make sure the front edge of the countertop is parallel to the cooktop. Make final check that all required clearances are met.

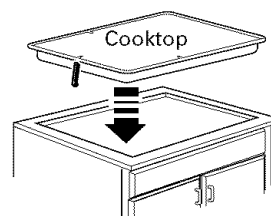

Once the unit is in place, screw the hold-down bracket into the cabinet sides to secure the unit into place.

Installation Instructions

INSTALLATION—GAS CONNECTIONS

1 PROVIDE ADEQUATE GAS SUPPLY

This cooktop is designed to operate on natural gas at 4" of water column manifold pressure and 7" of water column (W.C.) supply pressure. It is shipped from the factory set for natural gas. The convertible pressure regulator supplied with the unit must be connected in series with the manifold of the cooktop and must remain in series with the supply line regardless of whether natural or L.P. gas is being used. FOR PROPER OPERATION, THE MAXIMUM INLET PRESSURE TO THE REGULATOR MUST BE NO MORE THAN 14" OF WATER COLUMN PRESSURE. For checking the regulator, the inlet pressure must be at least 1" W.C.. (or 3.4 KPA) greater than the regulator output setting. If the regulator is set for 4" W.C. of water column pressure, the inlet pressure must be at least 5" W.C. If the regulator is set for 10" W.C., the inlet pressure must be at least 11" W.C.. The gas supply line to the cooktop should be 1/2" or 3/4" pipe.

2 INSTALL REGULATOR

NEVER REUSE OLD CONNECTORS WHEN INSTALLING THIS COOKTOP.

▲ WARNING: Never reuse old flexible connectors. The use of old flexible connectors can cause gas leaks and personal injury. Always use new flexible connectors when installing a gas appliance.

Screw a section of pipe onto the inlet end of the pressure regulator and install the coupling.

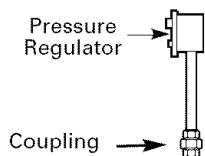

To reduce the likelihood of gas leaks, apply teflon tape or a thread compound approved for use with LP or Natural gases to all threaded connections.

3 INSTALL REGULATOR ONTO BURNER BOX BOTTOM

Screw the regulator onto the burner box bottom pipe connection. Make sure the top of the regulator is facing towards the cabinet front, easily accessible through the cabinet doors.

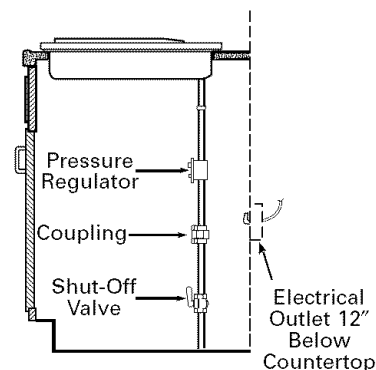

4 COMPLETE CONNECTION WITH A COUPLING

Complete the connection between the regulator pipe coupling and the shut-off valve.

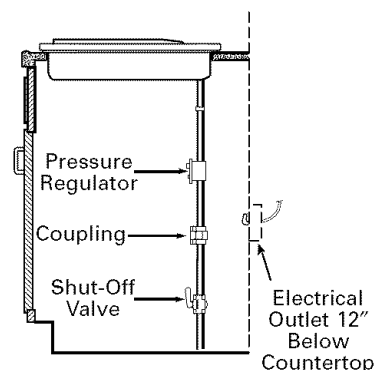

Installation Instructions

5 CHECK FOR LEAKS

Before testing for leaks, make sure all burner knobs are in the OFF position.

After connecting the cooktop to gas, check system for leaks with a manometer. If a manometer is not available, turn the gas supply on to the cooktop and use a liquid leak detector at all joints and connections to check for leaks.

Tighten all connections if necessary to prevent gas leakage in the cooktop or supply line.

DO NOT USE OPEN FLAME TO CHECK FOR LEAKS!

Disconnect the cooktop and its individual shut-off valve from the gas supply piping system during any pressure testing of that system at test pressures greater than 1/2 psig (3.5 kPa).

Isolate the cooktop from the gas supply piping system by closing its individual shut-off valve during any pressure testing of the gas supply system at test pressures equal to or less than 1/2 psig (3.5 kPa).

6 INSTALLATION OVER BUILT-IN OVEN

See built-in oven installation for complete installation instructions.

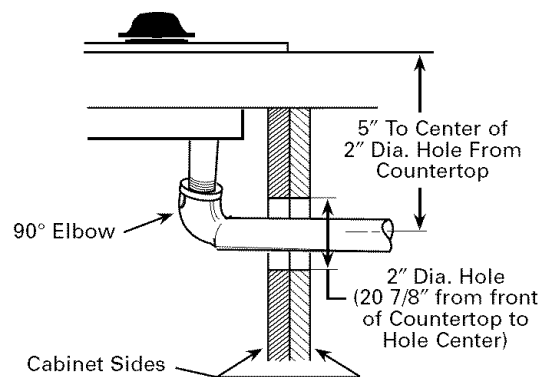

Installation Instructions

INSTALLATION—ELECTRICAL CONNECTIONS

⚠ WARNING — Disconnect all electrical power at the main circuit breaker or fuse box before installing.

1 EXTENSION CORDS

Because of potential safety hazards under certain conditions, we strongly recommend against the use of an extension cord. However, if you still elect to use an extension cord, it is absolutely necessary that it be a UL listed 3-wire grounding type appliance extension cord and that the current carrying rating of the cord in amperes be equivalent to or greater than the branch circuit rating. Such extension cords are obtainable through your local appliance dealer.

IMPORTANT: (Please read carefully)
**FOR PERSONAL SAFETY, THIS APPLIANCE
MUST BE PROPERLY GROUNDED.**

2 ELECTRICAL SUPPLY AND OUTLET

An adequate electrical supply and outlet must be used to operate the electrical parts of your cooktop.

- A** The power cord of this appliance is equipped with a 3-prong (grounding) plug which must be used with a properly grounded 3-hole outlet with a standard 120 Volt, 60 cycle AC household current.
- B** If you do not have a 3-hole grounded outlet, have a qualified electrician change your old one.
- C** A grounding adaptor will be needed to convert the old one until the outlet can be replaced. This method is only temporary, and a qualified electrician should test it to be sure it meets requirements.

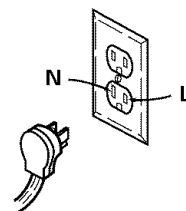

Insure proper
ground and
firm connection
before use

3 TWO-PRONG WALL RECEPTACLE

Where a standard 2-prong wall receptacle is encountered, it is the personal responsibility and obligation of the customer to have it replaced with a properly grounded 3-prong wall receptacle.

Do not under any circumstances cut or remove grounding prong from the cooktop cord. Failure to provide proper polarization may create a hazardous condition.

Installation Instructions

4 USAGE SITUATIONS WHERE APPLIANCE POWER CORD WILL BE DISCONNECTED INFREQUENTLY

For 15 amp circuit only. Do not use an adaptor on a 20 amp circuit. Where local codes permit, a TEMPORARY CONNECTION may be made to a properly grounded 2-prong wall receptacle by the use of a UL-listed adaptor available at most hardware stores. The larger slot in the adaptor must be aligned with the large slot in the wall receptacle to provide proper polarity in the connection of the power cord.

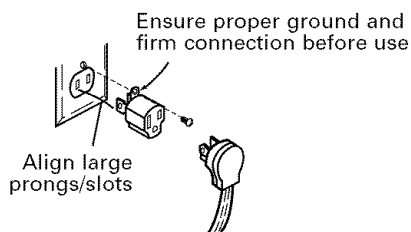

Temporary Method
(Adaptor plugs not permitted in Canada)

CAUTION: Attaching the adaptor ground terminal to the wall receptacle cover screw does not ground the appliance unless the screw is metal, and not insulated, and the wall receptacle is grounded through the house wiring. The customer should have the circuit checked by a qualified electrician to make sure the receptacle is properly grounded.

When disconnecting the power cord from the adaptor, always hold the adaptor with one hand. If this is not done, the adaptor ground terminal is very likely to break with repeated use. Should this happen, DO NOT USE the appliance until a proper ground has again been established.

Usage situation where appliance power cord will be disconnected frequently.

Do not use an adaptor plug in these situations because disconnection of the power cord places undue strain on the adaptor and leads to eventual failure of the adaptor ground terminal. The customer should have the 2-prong receptacle replaced with a 3-prong (grounding) receptacle by a qualified electrician before using the appliance.

Installation Instructions

COOKTOP BURNERS

1 ASSEMBLING THE COOKTOP BURNERS

The electrode of the spark igniter is exposed. Be careful not to push any cooktop controls while the top of the burner is removed. Do not remove the top or touch the electrode of any burner while another burner is turned on. Electrical shock might result.

A Replace the burner head onto the burner base, making sure that the head is properly oriented over the burner base and the electrode. Make sure to place the correct burner head on the correct burner base and that the burner head sits level on the burner base. The burner heads are not interchangeable.

B Place the burner caps on the burner heads, making sure to place the correct burner cap on the correct burner head. The burner caps are not interchangeable. Make sure that the burner caps are properly seated on the burner heads.

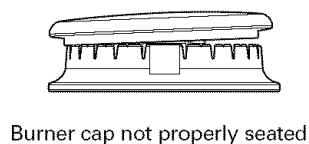
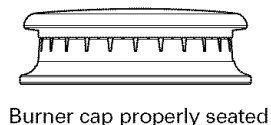

C Make sure the pins in the burner heads match the burner base indentations and that they are properly seated in them by rotating the heads until they are level.

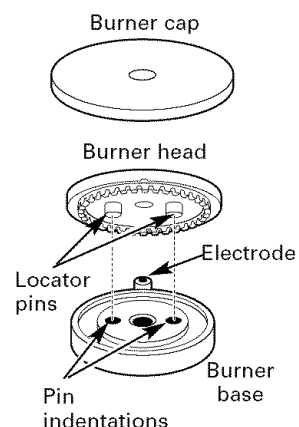

Make sure the slot in the burner head is positioned over the electrode. The burner cap has three to four pins. When replacing the cap, make sure none of the pins sits in the stability chamber.

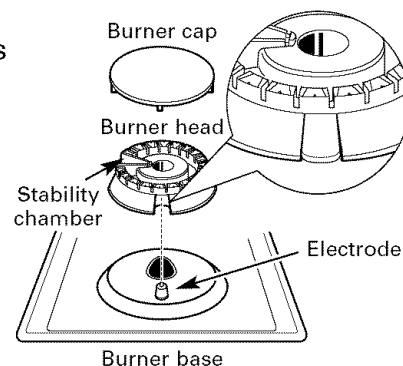

Make sure the hole in the burner head assembly is positioned over the electrode and that the burner head is fully inserted inside the burner base. A small gap between the base and head is normal.

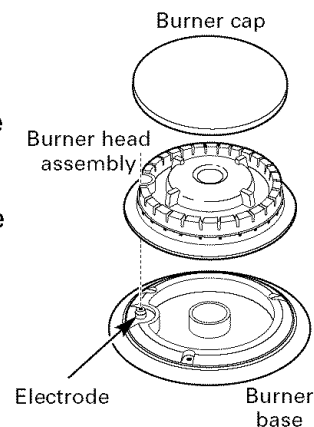

Installation Instructions

2 CHECK IGNITERS

Operation of the electric igniters should be checked after the cooktop and supply line have been carefully checked for leaks and the cooktop has been connected to the electrical power.

On models so equipped, check to be sure the cooktop is in the UNLOCKED position.

A Push and turn a burner valve to the LITE position. All spark igniters will make a series of sparks (ticking sounds), but only the burner turned to LITE will light.

- The burner should light when gas is available to the burner.
- Once the burner lights, it should be turned out of the LITE position.

B Try each valve separately until all burners have been checked.

3 BURNER IGNITION

Cooktop Spark Ignition—When you turn the cooktop knob to LITE, the spark igniter makes a series of electric sparks (ticking sounds) which light the burner. During a power failure, the burners will not light automatically. In an emergency, a cooktop burner may be lit with a match by following the steps below.

▲WARNING: Lighting gas burners with a match is dangerous. You should match light the cooktop burners only in an emergency.

On models so equipped, check to be sure the cooktop is in the UNLOCKED position.

- A** Light a match and hold the flame near the burner you want to light. Wooden matches work best.
- B** Push in and turn the control knob slowly. Be sure you are turning the correct knob for the burner you are lighting.

NOTE: If the burner does not light within five seconds, turn the knob off and wait one minute before trying again.

4 THE BURNER FLAMES

Turn each burner on. Flames should be blue in color with no trace of yellow. The burner flames should not flutter or blow away from the burner. The flame should be no less than 1/4" on the lowest setting and no greater than 1-1/2" on highest setting.

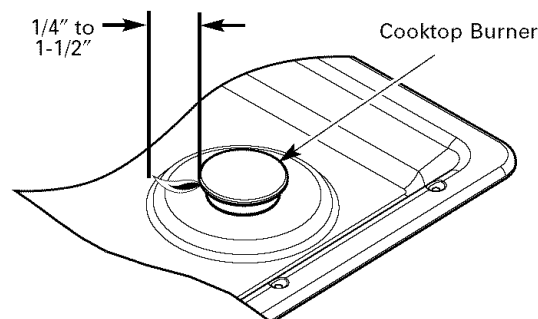

Burners should be checked frequently

▲WARNING: If you attempt to measure the flame, please use caution. Burns could result.

5 BURNER GRATES

The four cooktop grates are designed for specific positions. For maximum stability, these grates should only be used in their proper position: they should not be interchanged. For your convenience, the undersides of the left and right grates are marked "OUTSIDE" and "INSIDE". Make sure that the side marked "OUTSIDE" is on the outer edge of your cooktop.

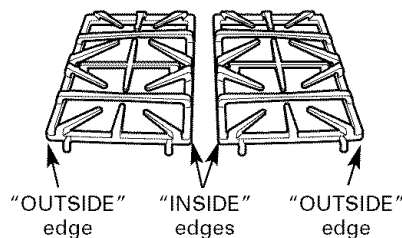

Installation Instructions

OPERATION CHECKLIST

- A** Make sure all controls are left in the OFF position. Check to be sure the cooktop is in the UNLOCKED position (on models so equipped).
- B** Make sure the flow of air to and from the cooktop is unobstructed.
- C** The serial plate for your cooktop is located on the bottom of the burner box. In addition to the model and serial numbers, it tells you the ratings of the burners and the type of fuel and pressure the cooktop was adjusted for when it left the factory.
- D** When ordering parts, always include the serial number, model number and a code letter to ensure proper replacement parts.
- E** **Recheck Steps:**
Double check to make sure everything in this guide has been completed. Rechecking steps will ensure safe use of the cooktop.

Installation Instructions

MAKING THE LP CONVERSION

1 SAFETY INFORMATION YOU SHOULD KNOW

The pressure regulator and burner orifices are set for natural gas. To use Propane Gas, the regulator and burner orifices must be converted. The LP orifice spuds for the cooktop burners can be located in the literature package attached to the regulator.

CAUTION: The cooktop, as shipped from the factory, is set for use with natural gas. If you wish to use your cooktop with Liquefied Petroleum (Propane) gas, you must first replace the orifices and convert the pressure regulator.

WARNING: This conversion must be performed by a qualified installer or gas supplier in accordance with the manufacturer's instructions and all codes and requirements of the authority having jurisdiction. Failure to follow instructions could result in serious injury or property damage. The qualified agency performing this work assumes responsibility for the conversion.

CAUTION: The following adjustments must be made before turning on the burner. Failure to do so could result in serious injury. Be sure pressure regulator has been converted as described in Step 2.

TOOLS YOU WILL NEED FOR LP CONVERSION



Phillips Head Screwdriver



7mm Nutdriver

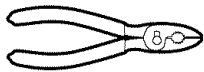

Pliers



No. 15 Torx-Head Driver



Safety Glasses

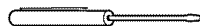

Small Flat-Head Screwdriver (4mm or 5/32" tip size, 60mm long)

2 ADJUST YOUR COOKTOP FOR USE WITH LP GAS

- A** Disconnect all electrical power, at the main circuit breaker or fuse box.
- B** Shut off the gas supply to the cooktop by closing the manual shut-off valve.
- C** Adjust the pressure regulator, by the following instructions:

- Unscrew the cap.
- Place your thumb against the flat side of the spring retainer and press down to remove the retainer.
- Carefully look at the spring retainer to locate the NAT or LP position.

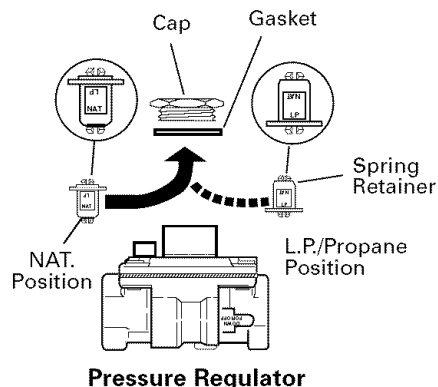

- Turn the spring retainer over so that LP is showing on the bottom.
- Snap the retainer back into position.
- Screw the cap back onto the regulator.

Installation Instructions

MAKING THE LP CONVERSION (CONT.)

3 CHANGE COOKTOP BURNER ORIFICES

A Remove the top grates, burner caps, and burner heads.

B Remove the spark igniters from the burner base (if required to access the orifices). Using a No. 15 "Torx" head driver bit, remove the screws holding the burner base in position.

C Using a 7mm nut driver, remove the top burner orifices. These may be accessed through the hole in the cooktop.

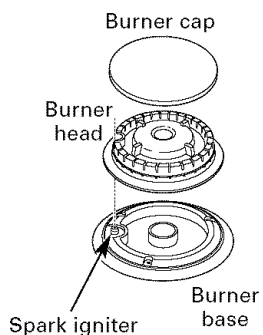
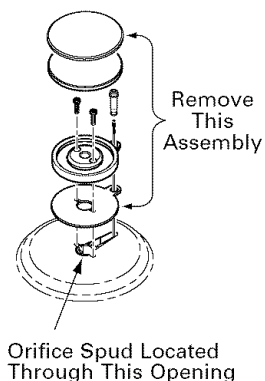

18,000 BTU Burner
(on some models)

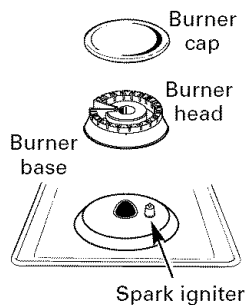

3 CHANGE COOKTOP BURNER ORIFICES (CONT.)

NOTE: On most burners, the orifices have a spring-loaded retaining ring around the hex head to hold the orifice in the nut driver during installation and removal. A slight amount of force is required to push the nut driver down over the ring.

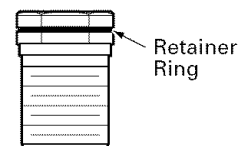

Installation Instructions

3 CHANGE COOKTOP BURNER ORIFICES (CONT.)

- D** Locate the LP/Propane orifices shipped inside the literature package. They will have a digit number and the letter "L" on the side. **(Important: Save the orifices removed from the appliance for future use.)**

Each orifice will show a series of engraved marks, (I, II, III, X or none), located on the top.

These marks denote the precise location of each orifice to the cooktop burner.



18,000 BTU/HR Burner (on some models)

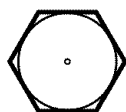

The 18,000 BTU/HR burner has two orifices with markings located in the sides only. (See rating plate on bottom of appliance).

NOTE: The main orifice is located low in the center of the burner while the simmer orifice is located higher behind the center of the burner.

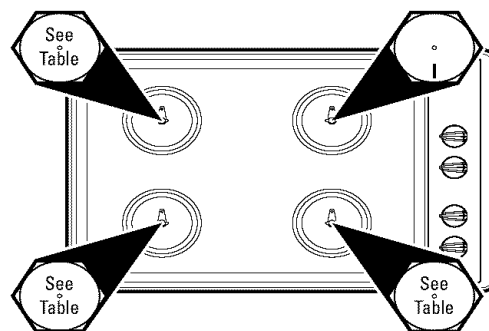
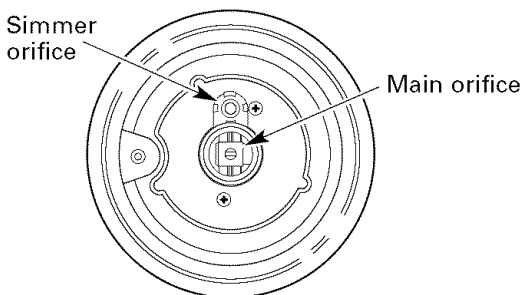

Model	Left Rear Orifice	Left Front Orifice	Right Front Orifice
JGP328	II	II	II
JGP330	II	II	III
JGP933	III	II	X
JGP940	III	III	X
JGP945	III	II	Main Simmer
			Replace: 206X N 57N
			With: 108X L 34L

- E** Install the LP/Propane orifices in their precise locations as noted in the illustrations above.
- F** Return the natural gas orifices to the bracket and reattach the bracket and the instruction sheet to the pressure regulator using the screw removed previously.
- G** Replace the burner bases, heads, caps and top grates. **(NOTE: When re-attaching the burner bases to glass top units, tighten screws to a maximum of 10 in.-lbs torque.)**

Installation Instructions

MAKING THE LP CONVERSION (CONT.)

4 ADJUST BURNER FLAMES

- A** Turn all burners full on and check the flames. They should be blue in color with some yellow tipping at the ends of the flame. Foreign particles in the gas line may cause an orange flame at first, but this will soon disappear.

NOTE: For the 18,000 BTU/HR burner (on some models) the cooktop burner knob should be turned to the setting before the lowest setting. This will ensure that the entire burner is operating.

- B** Turn the cooktop burner knob to the lowest setting while observing the flame.

Adjust the low flame setting using the valve bypass screw as follows:

Low-setting adjustments must be made with two other burners in operation on a medium setting. This prevents the low flame from being set too low, resulting in the flame being extinguished when other burners are turned on.

- C** To adjust the flame, remove the knobs. Insert a screwdriver through the access hole in valve switch. Engage adjustment screw in valve. Refer to the illustration below that matches the adjustment screw location for your model.

- If the flames were too small or fluttered, open the valve more than the original setting.
- If the flames blew away from the burner, close the valve more than the original setting.

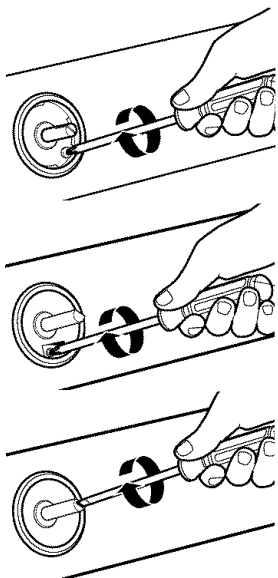

- D** Make the adjustment by slowly turning the screw until flame appearance is correct.

E Testing Flame Stability:

Test 1 – Turn the knob from “HI” to the lowest setting quickly. If the flame goes out at the lowest setting, increase the flame size and test again.

Test 2 – With the burner on the lowest setting, open and close the cabinet door under the cooktop. If the flame is extinguished by the air currents created by the door movement, increase the flame height and test again.

F Flame Recheck:

After the adjustment is made, turn all burners off. Ignite each burner individually. Observe the flame at the “HI” position. Rotate the valve to the lowest setting and be sure that the flame size decreases as the valve is rotated counterclockwise.

TO CONVERT THE COOKTOP BACK TO NATURAL GAS, REVERSE THE STEPS UNDER MAKING THE LP CONVERSION.

Once the conversion is complete and checked ok, fill out the LP sticker and include your name, organization and date conversion was made. Apply the sticker near the cooktop gas inlet opening to alert others in the future that this appliance has been converted to LP gas. If converting back to natural gas from LP, please remove the sticker so others know the appliance is set to use natural gas.