

Use & Care Manual

Gas Range

*ES100 Control with Gas Sealed Burners
& Broiler Drawer*



Visit the Frigidaire Web Site at: <http://www.frigidaire.com>

Welcome 2



Important Safety Instructions 2-4



Setting Surface Controls 5



Before Setting Oven Controls 6



Oven Control Functions 6-7



Setting Oven Controls 8-9



Adjusting Your Oven
Temperature (some models) 10



General Care & Cleaning 11-13



Before You Call
Solutions to Common Problems 14



Warranty Back Page



Questions or for Service Call:

1-800-944-9044 (U.S.)

1-800-668-4606 (Canada)



Welcome & Congratulations

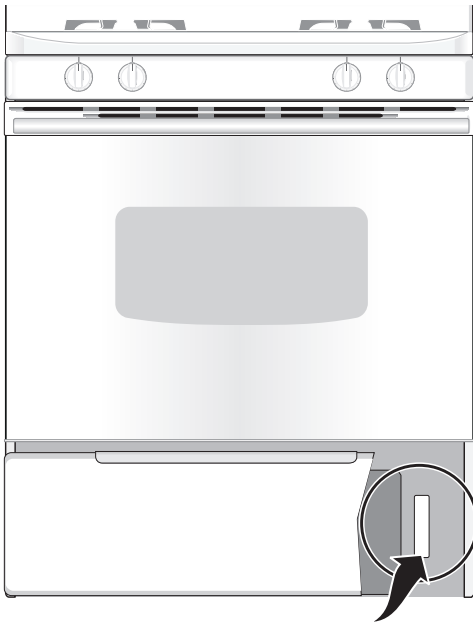

Serial plate is located behind the broil or storage drawer on the lower right side of the appliance frame.

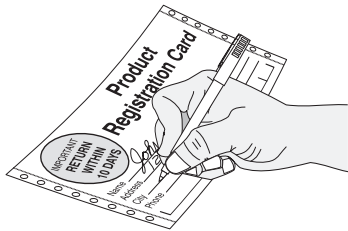

Congratulations on your purchase of a new range! At **Electrolux Home Products**, we are very proud of our product and are completely committed to providing you with the best service possible. Your satisfaction is our number one priority.

We know you'll enjoy your new range and **Thank You** for choosing our product. We hope you consider us for future purchases.

PLEASE CAREFULLY READ AND SAVE THESE INSTRUCTIONS

This Use & Care Manual provides specific operating instructions for your model. Use your appliance only as instructed in this manual. These instructions are not meant to cover every possible condition or situation that may occur. Common sense & caution must be practiced when installing, operating & maintaining any appliance.

Please record your model and serial numbers below for future reference.

Model Number: _____

Serial Number: _____

Purchase Date: _____

This Use & Care Manual contains general operating instructions for your appliance and feature information for several models. Your range **may not** have all the described features. The graphics shown are representative. The graphics on your range may not look exactly like those shown.

Product Registration

Be sure to register your product. The self-addressed **PRODUCT REGISTRATION CARD** should be filled in completely, signed and returned to Electrolux Home Products.



Important Safety Instructions

Grounding Instructions (electric ignition models only)

WARNING Avoid fire hazard or electrical shock. Do not use an adapter plug, an extension cord, or remove grounding prong from electrical power cord. Failure to follow this warning can cause serious injury, fire or death.

WARNING This appliance is equipped with a 3-prong grounding plug for your protection against shock hazard and should be plugged directly into a properly grounded receptacle. **DO NOT** cut or **REMOVE** the grounding prong from this plug.

For personal safety this appliance must be properly grounded. For maximum safety, the power cord must be plugged into an electrical outlet that is correctly polarized and properly grounded.

If a 2-prong wall receptacle is the only available outlet, it is the personal responsibility of the consumer to have it replaced with a properly grounded 3-prong wall receptacle installed by a qualified electrician.

© 2008 Electrolux Home Products, Inc.
All rights reserved.

Grounding type
wall receptacle

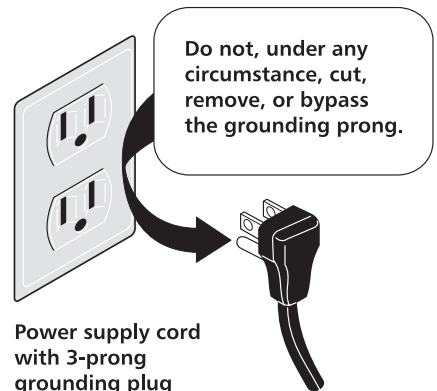

Power supply cord
with 3-prong
grounding plug

See the **INSTALLATION INSTRUCTIONS** packaged with this appliance for complete installation & grounding instructions.

Important Safety Instructions



**Read all instructions before using this appliance.
Save these instructions for future reference.**

This manual contains important safety symbols and instructions. Please pay attention to these symbols and follow all instructions given.

⚠ WARNING This symbol will help alert you to situations that may cause serious bodily harm, death or property damage.

⚠ CAUTION This symbol will help alert you to situations that may cause bodily injury or property damage.

⚠ WARNING If the information in this manual is not followed exactly, a fire or explosion may result causing property damage, personal injury or death.

FOR YOUR SAFETY:

- Do not store or use gasoline or other flammable vapors and liquids in the vicinity of this or any other appliance.
- **WHAT TO DO IF YOU SMELL GAS:**
 - Do not try to light any appliance.
 - Do not touch any electrical switch; do not use any phone in your building.
 - Immediately call your gas supplier from a neighbor's phone. Follow the gas supplier's instructions.
 - If you cannot reach your gas supplier, call the fire department.
- Installation and service must be performed by a qualified installer, servicer or the gas supplier.

- Remove all tape and packaging before using the range. Destroy the carton and plastic bags after unpacking the range. Never allow children to play with packaging material.
- **Proper Installation**—Be sure your appliance is properly installed and grounded by a qualified technician in accordance with the National Fuel Gas Code ANSI Z223.- latest edition, or in Canada CAN/CGA B149.1, and CAN/CGA B149.2, and the the National Electrical Code ANSI/NFPA No.70-latest edition, or in Canada CSA Standard C22.1, Canadian Electrical Code, Part 1, and local code requirements. Install only per installation instructions provided in the literature package for this range. Ask your Sears dealer to recommend a qualified technician and an authorized Sears repair service. Know how to disconnect the power to the range at the circuit breaker or fuse box in case of an emergency.
- **User servicing**—Do not repair or replace any part of the appliance unless specifically recommended in the manuals. All other servicing should be done only by a qualified technician, This may reduce the risk of personal injury and damage to the range.
- **Never modify or alter the construction of a range by removing leveling legs, panels, wire covers, anti-tip brackets/screws, or any other part of the product.**
- **Air curtain or other overhead range hoods, which operate by blowing a downward air flow on to a range, shall not be used in conjunction with gas ranges other than when the hood and range have been designed, tested and listed by an independent test laboratory for use in combination with each other.**

⚠ WARNING

- All ranges can tip.
- Injury to persons could result.
- Install anti-tip device packed with range.
- See Installation Instructions.



⚠ WARNING To reduce the risk of tipping, the range must be secured by properly installed anti-tip bracket provided with the range. To check if the bracket is installed properly, visually check that rear leveling leg is inserted into and fully secured by the anti-tip bracket by removing lower panel or storage drawer. For models with a warmer drawer, grasp the top rear edge of the range and carefully attempt to tilt it forward. Refer to the installation instructions for proper anti-tip bracket installation.

⚠ WARNING Stepping, leaning or sitting on the doors or drawers of this range can result in serious injuries and also cause damage to the range. Do not allow children to climb or play around the range. The weight of a child on an open door may cause the range to tip, resulting in serious burns or other injury.

⚠ WARNING NEVER use this appliance as a space heater to heat or warm the room. Doing so may result in carbon monoxide poisoning.

⚠ WARNING NEVER cover any slots, holes or passages in the oven bottom or cover an entire rack with materials such as aluminum foil. Doing so blocks air flow through the oven and may cause carbon monoxide poisoning. Aluminum foil linings may trap heat, causing a fire hazard.

⚠ WARNING Do not use the oven or warmer drawer (if equipped) for storage.

• **Storage in or on Appliance**—Flammable materials should not be stored in an oven, warmer drawer, near surface burners or in the storage drawer. This includes paper, plastic and cloth items, such as cookbooks, plasticware and towels, as well as flammable liquids. Do not store explosives, such as aerosol cans, on or near the range.

⚠ CAUTION Do not store items of interest to children in the cabinets above a range or on the backguard of a range. Children climbing on the range to reach items could be seriously injured.



Important Safety Instructions

- **Do Not Leave Children Alone**—Children should not be left alone or unattended in the area where appliance is in use. They should never be allowed to sit or stand on any part of the appliance.
- **DO NOT TOUCH SURFACE BURNERS, AREAS NEAR THESE BURNERS, OVEN BURNERS OR INTERIOR SURFACES OF THE OVEN.** Both surface and oven burners may be hot even though flames are not visible. Areas near surface burners may become hot enough to cause burns. During and after use, do not touch, or let clothing or other flammable materials touch these areas until they have had sufficient time to cool. Among these areas are the cook top, surfaces facing the cook top, the oven vent openings and surfaces near these openings, oven door and window.
- **Wear Proper Apparel**—Loose-fitting or hanging garments should never be worn while using the appliance. Do not let clothing or other flammable materials contact hot surfaces.
- **Do Not Use Water or Flour on Grease Fires**—Smother the fire with a pan lid, or use baking soda, a dry chemical or foam-type extinguisher.
- **When heating fat or grease, watch it closely.** Fat or grease may catch fire if allowed to become too hot.
- **Use Only Dry Potholders**—Moist or damp potholders on hot surfaces may result in burns from steam. Do not let potholders touch hot heating burners. Do not use a towel or other bulky cloth instead of a potholder.
- **Do Not Heat Unopened Food Containers**—Buildup of pressure may cause container to burst and result in injury.
- **Remove the oven door from any unused range if it is to be stored or discarded.**

IMPORTANT—ELECTRIC IGNITION MODELS ONLY: Do not attempt to operate the oven during a power failure. If the power fails, always turn off the oven. If the oven is not turned off and the power resumes, the oven will begin to operate again. Once the power resumes, reset the clock and oven function.

IMPORTANT INSTRUCTIONS FOR USING YOUR COOKTOP

- **⚠️ WARNING Use Proper Flame Size**—Adjust flame size so it does not extend beyond the edge of the utensil. The use of undersized utensils will expose a portion of the burner flame to direct contact and may result in ignition of clothing. Proper relationship of utensil to flame will also improve efficiency.
- **Know which knob controls each surface burner.** Place a pan of food on the burner before turning it on, and turn the burner off before removing the pan.
- **Always turn knob to the full LITE position when igniting top burners.** Visually check that burner has lit. Then adjust the flame so it does not extend beyond the edge of the utensil.
- **Utensil Handles Should Be Turned Inward and Not Extend Over Adjacent Surface Burners**—To reduce the risk of burns, ignition of flammable materials, and spillage due to unintentional contact with the utensil, the handle of the utensil should be positioned so that it is turned inward, and does not extend over adjacent surface burners.

- **Never Leave Surface Burners Unattended at High Heat Settings**—Boilovers cause smoking and greasy spillovers that may ignite, or a pan that has boiled dry may melt.
- **Protective Liners**—Do not use aluminum foil to line surface burner pans, or oven bottom, except as suggested in this manual. Improper installation of these liners may result in risk of electric shock, or fire.
- **Glazed Cooking Utensils**—Only certain types of glass, glass/ceramic, ceramic, earthenware, or other glazed utensils are suitable for cooktop service without breaking due to the sudden change in temperature. Check the manufacturer's recommendations for cooktop use.

IMPORTANT INSTRUCTIONS FOR USING YOUR OVEN

- **Use Care When Opening Oven Door or Warmer Drawer**—Stand to the side of the range when opening the door of a hot oven. Let hot air or steam escape before you remove or replace food in the oven.
- **Keep Oven Vent Ducts Unobstructed.** The oven vent is located below the backguard. Touching the surfaces in this area when the oven is operating may cause severe burns. Also, do not place plastic or heat-sensitive items on or near the oven vent. These items could melt or ignite.
- **Placement of Oven Racks.** Always place oven racks in desired location while oven is cool. If rack must be moved while oven is hot use extreme caution. Use potholders and grasp the rack with both hands to reposition. Do not let potholders contact the hot heating elements in the oven. Remove all utensils from the rack before moving.
- **Do not use the broiler pan without its insert.** The broiler pan and its insert allow dripping fat to drain and be kept away from the high heat of the broiler.
- **Do not cover the broiler insert with aluminum foil. Exposed fat and grease could ignite.**
- Cold temperatures can damage the electronic control. When using the appliance for the first time, or when the appliance has not been used for an extended period of time, be certain the unit has been in temperatures above 32°F (0°C) for at least 3 hours before turning on the power to the appliance.

IMPORTANT INSTRUCTIONS FOR CLEANING YOUR RANGE

- **Clean the range regularly to keep all parts free of grease that could catch fire.** Pay particular attention to the area underneath each surface element. Do not allow grease to accumulate. Refer to the range manufacturer's instructions for cleaning.
- **Kitchen cleaners and aerosols**—Always follow the manufacturer's recommended directions for use. Be aware that excess residue from cleaners and aerosols may ignite causing damage and injury.

IMPORTANT SAFETY NOTICE

The California Safe Drinking Water and Toxic Enforcement Act requires the Governor of California to publish a list of substances known to the state to cause cancer, birth defects or other reproductive harm, and requires businesses to warn customers of potential exposure to such substances.

Setting Surface Controls



CAUTION Do not place plastic items such as salt and pepper shakers, spoon holders or plastic wrappings on top of the range when it is in use. These items could melt or ignite. Potholders, towels or wood spoons could catch fire if placed too close to a flame.

In the event of an electrical power outage, the surface burners can be lit manually. To light a surface burner, hold a lit match to the burner head, then slowly turn the Surface Control knob to **LITE**. After burner lights push in and turn knob to desired setting. Use **CAUTION** when lighting surface burners manually.



Setting Surface Controls

Your range may be equipped with different sized surface burners. The ability to heat food quicker and in larger volumes increases as the burner size increases. The simmer burner (if equipped) is best used for simmering delicate sauces, etc. The standard burners can be used for most surface cooking needs. The **Power Plus™** burners (if equipped) are best used for bringing large quantities of liquid to temperature and when preparing larger quantities of food.

Regardless of size, always select cookware that is suitable for the amount and type of food being prepared. Select a burner and flame size appropriate to the pan. Never allow flames to extend beyond the outer edge of the pan.

Each burner lights automatically from an electric ignitor each time a control knob is turned to the **LITE** position.

Operating the Surface Burners

1. Place cooking utensil on surface burner.
2. Push the surface control knob in and turn **counterclockwise** out of the OFF position.
3. Release the knob and rotate to the LITE position. Note: All four electronic surface ignitors will spark at the same time. However, only the burner you are turning on will ignite.
3. Visually check that the burner has lit.
4. Push the control knob in and turn **counterclockwise** to the desired flame size. The control knobs do not have to be set at a particular setting. Use the guides and adjust the flame as needed. **DO NOT** cook with the surface control knob in the LITE position. (The electronic ignitor will continue to spark if the knob is left in the LITE position.)

Setting Proper Surface Burner Flame Size

For most cooking: Start on the highest control setting and then turn to a lower one to complete the process. Use the recommendations below as a guide for determining proper flame size for various types of cooking. The size and type of utensil used and the amount of food being cooked will influence the setting needed for cooking.

For deep fat frying: Use a thermometer & adjust the surface control knob accordingly. If the fat is too cool, the food will absorb the fat and be greasy. If the fat is too hot, the food will brown so quickly that the center will be undercooked. Do not attempt to deep fat fry too much food at once as the food will neither brown nor cook properly.



**Proper
Flame
Size**



**Improper
Flame
Size**

Never extend the flame beyond the outer edge of the utensil. A higher flame simply wastes heat and energy, and increases your risk of being burned by the flame.

*Flame Size

High Flame
Medium Flame
Low Flame

Type of Cooking

Start most foods; bring water to a boil; pan broiling.
Maintain a slow boil; thicken sauces, gravies; steaming.
Keep foods cooking; poach; stewing.

***These settings are based on using medium-weight metal or aluminum cookware with lids. Settings may vary when using other types of cookware.** The color of the flame is the key to proper burner adjustment. A good flame is clear, blue & nearly invisible in a well-lighted room. Each cone of flame should be steady & sharp. Adjust or clean burner if flame is yellow-orange.



Before Setting Oven Controls

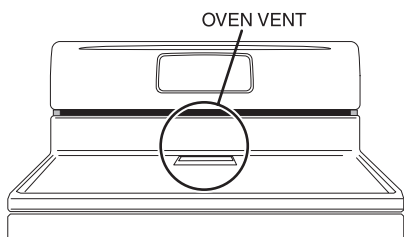

Oven Vent Location

The oven vent is located **below the backguard**. When the oven is on, warm air is released through this vent. This venting is necessary for proper air circulation in the oven and good baking results. **DO NOT BLOCK THE OVEN VENT.**

Arranging Oven Racks

ALWAYS ARRANGE OVEN RACKS WHEN THE OVEN IS COOL (PRIOR TO OPERATING THE OVEN). Always use oven mitts when using the oven.

Removing & Replacing Oven Racks

To remove, pull the rack forward until it stops. Lift up front of rack and slide out. **To replace**, fit the rack onto the guides on the oven walls. Tilt the front of the rack upward and slide the rack back into place.

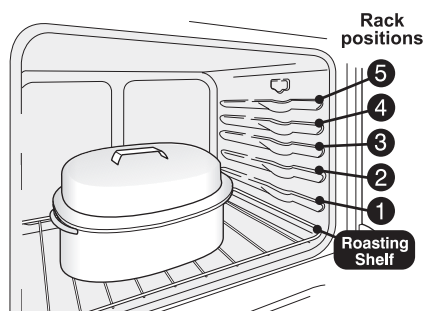

Arranging Oven Racks with 6 Rack Positions

To bake on a single rack, place the rack on position 2 or 3. **To bake on 2 racks**, place the racks on positions 1 & 3.

Recommended Rack Positions for Broiling, Baking & Roasting:

Food	Rack Position
Broiling meats, chicken or fish.	4 or 5
Cookies, cakes, pies, biscuits & muffins.	2 or 3
Frozen pies, angel food cake, yeast, bread, casseroles, small cuts of meat or poultry.	1
Turkey, roast or ham.	1 or Roasting Shelf



Oven Control Functions

Note: The time of day **must** first be set in order to operate the oven.

READ THE INSTRUCTIONS CAREFULLY BEFORE USING THE OVEN. For satisfactory use of your oven, become familiar with the various functions of the oven as described below.

BAKE PAD—Used to select the bake function.

BROIL PAD—Used to select the variable broil function.

TIMER ON/OFF PAD—Used to set or cancel the minute timer. The minute timer does not start or stop cooking.

CLOCK SET PAD—Used to set the time of day.

CLEAR/OFF—Used to clear any function previously entered except the time of day and minute timer. Press **CLEAR/OFF** to stop cooking.

UP & DOWN ARROW PADS—Used along with the function pads to select oven temperature, time of day, clean time & minute timer.

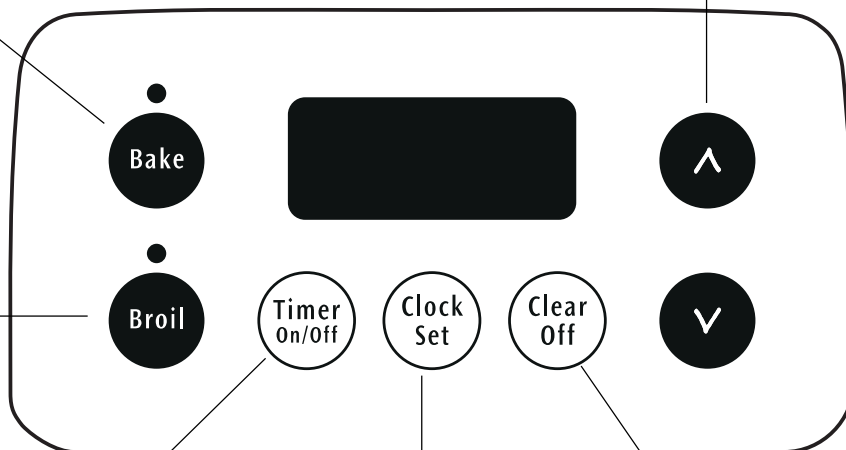

Oven Control Functions





Note: The time of day **must** first be set in order to operate the oven.

To Set the Clock

When the range is first plugged in, or when the power supply to the range has been interrupted, the display will flash "12:00".

1. Press .
2. Within 5 seconds, press and hold the  or  until the correct time of day appears in the display.

To Set the Minute Timer:



1. Press .
2. Press the  to increase the time in one minute increments. Press and hold the  to increase the time in 10 minute increments. The timer can be set for any amount of time from 1 minute to 11 hours and 59 minutes.

Note: If you press the  first, the timer will advance to 11 hours and 59 minutes.

3. The display shows the timer count down in minutes until one minute remains. Then the display will count down in seconds.
4. When the set time has run out, the timer will sound a 3 second beep. 0:00 will appear in the display until  is pressed.

Note: While the minute timer is counting down, the ":" will flash. The minute timer does not start or stop cooking. It serves as an extra timer in the kitchen that will beep when the set time has run out. The minute timer can be used alone or during any of the other oven functions. When the minute timer is in use with any other function, the minute timer will be shown in the display. To view other functions, press the pad for that function.

To Change the Minute Timer while it is in use:

While the timer is active and shows in the display, press and hold the  or  to increase or decrease the time.





To Cancel the Minute Timer before the set time has run out: Press .

Changing the Temperature Display Mode (some models)

The electronic oven control temperature display mode was factory preset to display (Fahrenheit) °F oven temperatures.

Note: Oven cooking temperatures may be set from 170°F to 550°F (77°C to 287°C).

To change the Temperature Display Mode to °C (Celsius) or from °C to °F (do not use Bake or Broil while changing the Temperature Display Mode):

1. Press & hold the  key pad for 6-8 seconds until **F** or **C** appears in the display. **Note:** At this time the display will show the current Temperature Display Mode whether set for **F** or **C**.
2. Press the  key pad once to choose the (Fahrenheit) °F mode; or press the  key pad once to choose the (Celsius) °C mode.
3. After 5 seconds, the display will flash. To accept the change, wait 5 more seconds until the oven control beeps once. To complete the change skip step 4 below, **OR**;
4. If at any time during the process of changing the Temperature Display Mode (**F** or **C**) you decide the change is not desired, press the  key pad before the oven control beeps once to **cancel** the process.
5. The control will beep once. The display will then return to the time of day with any temperature display mode change you may have requested.



Setting Oven Controls

Note: The time of day must first be set in order to operate the oven.

To Set or Change the Temperature for Baking

The oven can be programmed to bake at any temperature from 170°F to 500°F.

To Set the Controls for Baking:

1. Press **Bake**. "— — —" appears in the display.
2. Within 5 seconds, press the **▲** or **▼**. The display will show "350°F." By pressing and holding the **▲** or **▼**, the temperature can then be adjusted in 5°F increments.
3. When the **▲** or **▼** is released, the oven will begin heating to the selected temperature. When the displayed temperature reaches the desired baking temperature, the control will beep once.
4. To cancel the baking function, press **Clear Off**.

To Change the Oven Temperature after Baking has Started:

1. Press **Bake** and make sure the bake temperature is displayed.
2. Press the **▲** or **▼** to increase or decrease the set temperature.

Setting Oven Controls



Note: The time of day must first be set in order to operate the oven.

To Broil

1. Slide broiler drawer out to the stop position.
2. Remove broiler pan & insert (See Fig. 1).
3. Position rack before setting control; while range is cool.
4. Position rack by tilting front of rack up & pulling rack out from locating holes in rear of broiler drawer. Reposition back of rack in the desired locating holes & allow front of rack to slide down into the corresponding slots in front of broiler drawer (See Fig. 2). **NOTE:** For medium-rare meats, position the rack closer to the burner (upper position). For medium foods use middle position. For well-done foods such as chicken, lobster tails or thick cuts of meat, position the rack further from the burner (lower position).
5. Place insert on broiler pan, then place meat on insert. **DO NOT** use the broiler pan without the insert. **DO NOT** cover the insert with aluminum foil. The exposed fat could ignite.
6. Place broiler pan on rack; make sure the broiler pan with the insert is positioned as shown (See Fig.1). Be sure front of pan is positioned correctly in rack.
7. Slide the broiler drawer all the way into the range. Press

Broil on Oven Control.

8. Press and hold the **▲** or **▼** until the desired broil setting level appears in the display. Press the **▲** for **HI** (high) broil or the **▼** for **LO** (low) broil. Most foods can be broiled at the **HI** broil setting. Select the **LO** broil setting to avoid excess browning or drying of foods that should be broiled to the well-done stage.
9. Broil on one side until food is browned; turn and cook on the second side. **Note:** Always pull the rack out to the stop position before turning or removing food.
10. When broiling is finished, press **Clear Off**.
11. When removing broiler pan from broiler drawer always use pot holders.

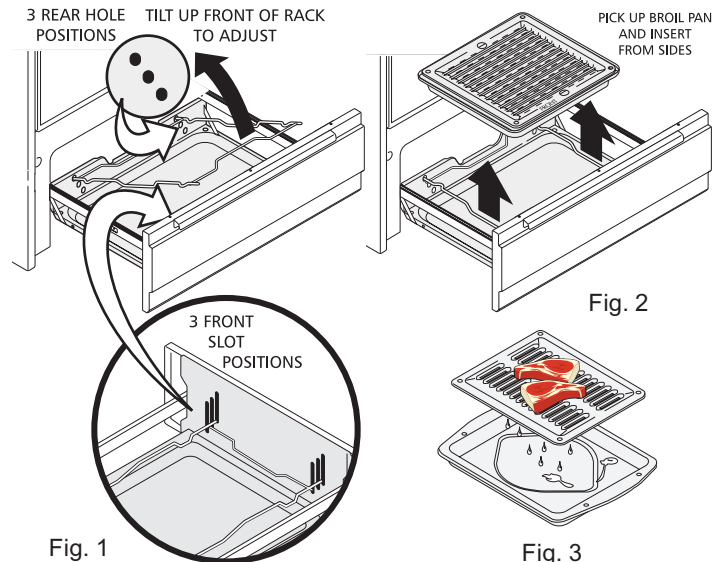

NOTE: The broiler pan & insert allows grease to drain and be kept away from the high heat of the broiler (See Fig. 3). **DO NOT** use the pan without the insert. **DO NOT** cover the insert with foil; the exposed grease could ignite.

WARNING **DO NOT** use the broiler drawer for storage. Items placed in the broiler drawer will catch fire.

CAUTION Should an oven fire occur, close the oven door and turn off the oven. If the fire continues, use a fire extinguisher. **DO NOT** put water or flour on the fire. Flour may be explosive.









Adjusting Your Oven Temperature (some models)

Your new oven has been factory calibrated and tested to ensure an accurate baking temperature. For the first few uses, follow your recipe times and temperature recommendations carefully. If you feel your oven is too hot or too cool from your baking experience, the oven temperature may be adjusted to your liking.

Note: DO NOT adjust your oven temperature based on oven thermometers, such as those found in grocery stores, they may not be accurate.

To Adjust the Oven Temperature (do not use Bake or Broil while adjusting the oven temperature):

1. Press & hold the  key pad and release after the display begins flashing the factory temperature setting of **00**.
Note: If the oven temperature has been previously adjusted from the factory setting, the current temperature adjusted value will flash in the display instead.
2. You may increase the oven temperature in 5°F increments with each press of the  key pad to a maximum oven adjustment of +35°F. You may also adjust the oven temperature downward in 5°F increments with each press of the  key pad (total adjustment range of **-35** to **+35**F. **Note:** Your oven control was factory set in the (Fahrenheit) °F Temperature Display Mode. To change for (Celsius) °C, see **Changing the Temperature Display Mode** in the Oven Control Functions section of this Use & Care Manual.
3. If no other key pad is pressed after 5 seconds the display will begin to flash.
4. If you **do not want** to keep the display adjustment, press the  key pad before the oven control beeps. This will cancel the temperature adjustment procedure. To start this procedure over again begin with step 1 above **OR**;
5. If **you want** to keep the adjustment, wait until the display quits flashing and the oven control beeps once.
6. The oven temperature adjustment has been accepted by the oven control and the display will return to the time of day.

Notes: The oven temperature adjustment may be made if your oven control has been set to operate in the (Celsius) °C **Temperature Display Mode**. In this case each press of the  or  key will adjust in 1°C increments upward (maximum +18°C) or downward (maximum -18°C), depending on which arrow key pad is pressed.

General Care & Cleaning

(Cleaning Chart)



Surfaces	How to Clean
Aluminum (Trim Pieces) & Vinyl	Use hot, soapy water and a cloth. Dry with a clean cloth.
Glass, Painted Plastic Body Parts & Control Knobs	<i>For general cleaning</i> , use hot, soapy water and a cloth. <i>For more difficult soils and built-up grease</i> , apply a liquid detergent directly onto the soil. Leave on soil for 30 to 60 minutes. Rinse with a damp cloth and dry. DO NOT use abrasive cleaners on any of these materials; they can scratch.
Painted Control Panels	<i>Before cleaning the control panel</i> , turn all controls to OFF and remove the control knobs. To remove, pull each knob straight off the shaft. Clean as instructed above. Squeeze excess water from the cloth before wiping the panel; especially when wiping around the controls. Excess water in or around the controls may cause damage to the appliance. To replace knobs after cleaning, line up the flat sides of both the knob and the shaft, then push the knob(s) into place.
Porcelain Enamel, Broiler Pan & Insert (some models), Broiler Drawer, Door Liner & Oven Bottom	Gentle scouring with a soapy scouring pad will remove most spots. Rinse with a 1:1 solution of clean water and ammonia. <i>If necessary</i> , cover difficult spots with an ammonia-soaked paper towel for 30 to 40 minutes. Rinse with clean water and a damp cloth, then scrub with a soap-filled scouring pad. Rinse and wipe dry with a clean cloth. Remove all cleaners or the porcelain may become damaged during future heating. DO NOT use spray oven cleaners on the range top.
Oven Racks	Remove racks. See "Removing & Replacing Oven Racks" under Before Setting Oven Controls . Use a mild, abrasive cleaner, following the cleaner's recommendations. Rinse with clean water & let dry. After cleaning the racks, rub the sides of the racks with wax paper or a cloth containing a small amount of salad oil (this will make the racks glide easier into the oven rack positions).
Oven Door	Use soap & water to thoroughly clean the top, sides & front of the oven door. Rinse well. You may use a glass cleaner on the outside glass of the oven door. DO NOT immerse the door in water. DO NOT spray or allow water or the glass cleaner to enter the door vents. DO NOT use oven cleaners, cleaning powders or any harsh abrasive cleaning materials on the outside of the oven door. DO NOT clean the oven door gasket. The oven door gasket is made of a woven material, on Self-Cleaning models, which is essential for a good seal. Care should be taken not to rub, damage or remove this gasket.
For cooktop, burners caps, burner heads and grates	See "Cleaning the Cooktop" later in this section
Stainless Steel (some models)	Clean stainless steel with a dishcloth using hot, soapy water. Rinse with clean water & a cloth. Do not use cleaners with high concentrations of chlorides or chlorines. Do not use harsh scrubbing cleaners. Only use kitchen cleaners that are especially made for cleaning stainless steel. Always be sure to rinse the cleaners from the surface as bluish stains may occur during heating that cannot be removed.



General Care & Cleaning

Cleaning the Cooktop

The cooktop is designed to make cleaning easier. Since the four burners are sealed, cleanups are easy when spillovers are cleaned up immediately. To clean, wipe with a clean, damp cloth and wipe dry. **DO NOT** attempt to clean the cooktop when the cooktop or burner heads are still hot. The contoured well areas and burner drip pans (some models) should be routinely cleaned. Keeping the burner head ports and slots clean will prevent improper ignition and an uneven flame. Refer to the following sections for further instructions.

CAUTION **DO NOT** attempt to clean the cooktop when the cooktop or burner heads are still hot. Touching hot cooktop areas, burner grates and burner caps can cause burns.

CAUTION Any additions, changes or conversions required in order for this appliance to satisfactorily meet the application needs must be made by an authorized **Electrolux** Distributor or Qualified Agency.

To clean the burner head ignition ports - Each burner head has a small ignition port located as illustrated. Should you experience ignition problems it may be that this port hole is partially blocked with soil. With the burner head in place, use a small wire gauge needle or the end of a paper clip to clear the ignition port.

To Clean the Surface Burner Heads - For proper gas flow it may be necessary to clean the burner head and slots. To clean, first use a clean **DAMP** cloth to soak up any spills. Remove any food from between the burner slots using a small non-abrasive brush like a toothbrush and afterwards wipe up using a damp cloth. For stubborn soils located in the slots, use a small-gauge wire or needle to clean the slots.

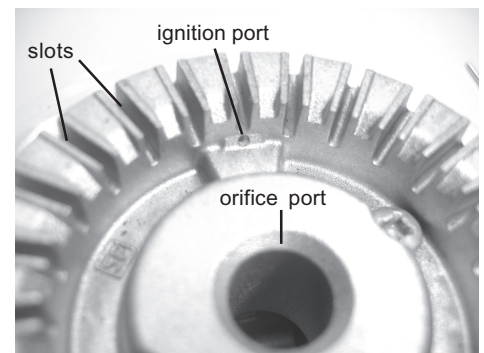

Cooktop Burner Head

Please Note: The surface burner heads are secured to the cooktop and must be cleaned in place on the cooktop.

For proper flow of gas and ignition of the burner — **DO NOT ALLOW SPILLS, FOOD, CLEANING AGENTS OR ANY OTHER MATERIAL TO ENTER THE GAS ORIFICE HOLDER OPENING. ALWAYS** keep the surface burner cap and surface burner head in place whenever a surface burner is in use.

To Clean the Recessed and Contoured Well Areas of the Cooktop - If a spill occurs on or in the recessed or contoured areas, blot up spill with an absorbent cloth. Rinse with a clean, damp cloth and wipe dry.

To Clean the Surface Burner Grates, Caps & Surface Burner Drip Pans (some models) - Use a soap-filled scouring pad or a mild abrasive cleanser to clean the surface burner caps and surface burner drip pans (if equipped).

Please Note: **THE COOKTOP IS NOT REMOVABLE.** Do not attempt to remove or lift the cooktop.

General Care & Cleaning

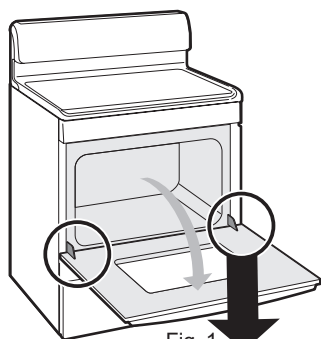

Fig. 1

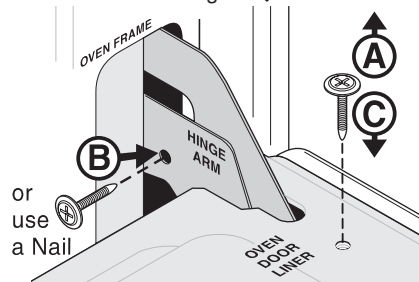

Fig. 2

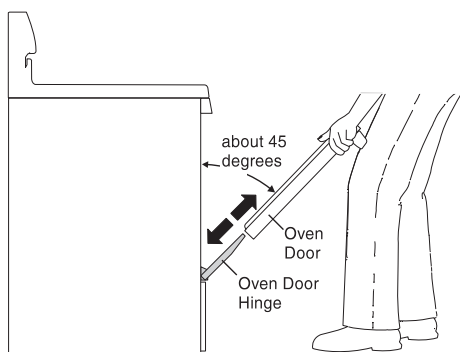
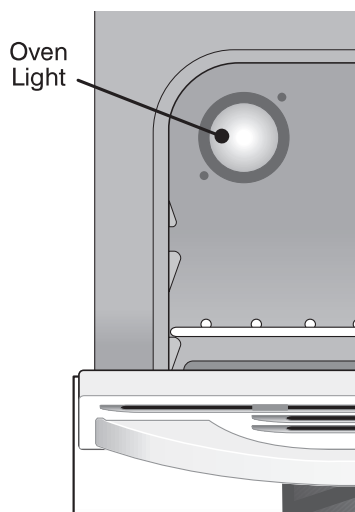

Fig. 3



Removing & Replacing the Oven Door (all models)

CAUTION The door is heavy. For safe, temporary storage, lay the door flat with the inside of the door facing down.

To Remove Oven Door:

1. Open oven door completely (horizontal with floor - See Fig. 1).
2. Remove 2 screws located on the inside of the oven door liner (See **A** Fig. 2).
3. Insert the 2 screws into the door hinge holes located on the side of the hinge arm, one into each hinge (See **B** Fig. 2).
4. Close oven door until the door stops, (Do not force the door to close any further). The placement of these screws should keep door open in about a 45 degree position.
5. Grasp oven door firmly on both sides and slide door up and off hinges at the same angle. (See Fig. 3)
6. To clean oven door, follow the instructions provided in the Cleaning Chart at the beginning of the **Care & Cleaning** section (See Door Liner).

To Replace Oven Door:

1. Be sure the hinge arms remain at the 45 degree angle position. Be sure the screws are still locking the hinge arms from moving. If the screws fall out of the hinge holes, the hinge(s) may snap back against the oven frame and could pinch fingers or chip the porcelain finish on the oven front frame.
2. Hold door at the sides near the top while resting the lower front of door on your knee. Insert the door channels at the bottom of door over the door hinges, (See Fig. 3).
3. Allow the door to slide down into the door hinges evenly at the same 45 degree angle. The hinge arms should be inserted into the bottom corners as far as they can go.
4. Open door completely (horizontal with floor) and remove both screws from holes in door hinges.
5. Reinstall the 2 screws into the door liner (See **C** Fig. 2).
6. If the door is not in alignment with the oven frame, remove door and repeat the above steps.

Changing the Oven Light (some models)

On some models, the oven light automatically turns on when the door is opened. Some models have a switch located on the control panel to turn on the light. The oven light is located at the rear of the oven.

To replace the oven light:

1. Turn electrical power off at the main source or unplug the range.
2. Replace bulb with a new 40 watt appliance bulb.
3. Turn power back on again at the main source (or plug the range back in).
4. The clock will then need to be reset. To reset, see "Setting the Clock" and "Setting the Minute Timer" under **Setting Oven Controls** in this Use & Care Manual.

CAUTION Be sure the range is unplugged and all parts are COOL before replacing oven light. Wear a leather-faced glove for protection against possible broken glass.



Before You Call

Solutions to Common Problems

Before you call for service, review the following list. It may save you time & expense. The list includes common occurrences (shown in bold) that are not the result of defective workmanship or materials in this appliance. The possible corrections to these problems are provided with the problem listed:

Range is not level - (1) Poor installation. Place oven rack in center of oven. Place a level on the oven rack. Adjust leveling legs at base of range until the oven rack is level. (2) Be sure floor is level, strong & stable enough to adequately support range. (3) If floor is sagging or sloping, contact a carpenter to correct the situation. (4) Kitchen cabinet alignment may make range appear not level. Be sure cabinets are square & have sufficient room for range clearance.

Cannot move appliance easily. Appliance must be accessible for service - (1) Cabinets not square or are built in too tightly. Contact builder or installer to make appliance accessible. (2) Carpet interferes with range. Provide sufficient space so range can be lifted over carpet.

Surface Burners do not light - (1) Surface Control knob was not completely turned to LITE. Push in & turn the Surface Control knob to LITE until burner ignites and then turn control knob to desired flame size. (2) Burner ports are clogged. With the burner OFF, use a small-gauge wire or needle to clean ports. See "Cleaning the Contoured Well Areas, Burner Caps, Head & Drip Pans" in the **General Care & Cleaning** section for additional cleaning instructions. (3) Range power cord is disconnected from outlet (electric ignition models only). Be sure power cord is securely plugged into the outlet. (4) Electrical power outage (electric ignition models only). Burners can be lit manually. See section on **Setting Surface Controls**.

Surface burner flame burns only part way around burner cap - (1) Burner ports are clogged. With the gas burner OFF, clean ports with a small-gauge wire or needle. (2) Moisture is present after cleaning. Lightly fan the flame & allow burner to operate until flame is full. Dry the burners thoroughly following the instructions under "Cleaning the Contoured Well Areas, Burner Caps, Head & Drip Pans" in the **General Care & Cleaning** section.

Surface burner flame is orange - (1) Dust particles in gas main line. Allow the gas burner to operate a few minutes until flame turns blue in color. (2) In coastal areas a slightly orange flame may be unavoidable due to salt in air.

Oven does not operate - (1) Be sure the oven controls are set properly for the desired function. See **Setting Oven Controls** in this Use & Care Manual or read the instructions for "Entire appliance does not operate" listed below. (2) Be sure the Gas Regulator Valve is in the "ON" position. Refer to the **Installation Instructions** to for more information.

Entire appliance does not operate - (1) The time of day is not set. The time of day **must** first be set in order to operate the oven. See "To Set the Clock" in the **Setting Oven Controls** section. (2) Make sure cord/plug is plugged correctly into outlet. (3) Service wiring is not complete. Contact your dealer, installing agent or authorized service agent. (4) Electrical power outage (electric ignition models only). Check house lights to be sure. Call your local electric company for service. Surface gas burners can be lit manually. See **Setting Surface Controls** in this Use & Care Manual.

Poor baking results - Many factors affect baking results. Make sure the proper oven rack position is used. Center food in the oven & space pans to allow air to circulate. Allow the oven to preheat to the set temperature before placing food in the oven. Try adjusting the recipe's recommended temperature or baking time.

Oven light does not work (some models) - Replace or tighten bulb. See **Changing Oven Light** section in this Use & Care Manual.

Oven smokes excessively during broiling - (1) Control(s) not set properly. Follow Broil instructions under **Setting Oven Controls**. (2) Broiler Drawer is open. The Broiler Drawer should be closed while broiling. (3) Meat too close to the broil element. Reposition the broil rack to provide proper clearance between the meat & the element. Preheat the broil element for searing. (4) Meat not properly prepared. Remove excess fat from meat. Cut remaining fatty edges to prevent curling, but do not cut into lean. (5) Insert on broiler pan wrong side up & grease not draining. Always place grid on the broiler pan with ribs up & slots down to allow grease to drip into pan (some models). (6) Grease has built up on oven surfaces. Regular cleaning is necessary when broiling frequently. Old grease or food spatters cause excessive smoking.

Flames inside oven or smoking from oven vent - Excessive spillovers in oven. This will especially be the case for pie spillovers or large amounts of grease on the oven bottom. Wipe up excessive spillovers before starting oven. If flames or excessive smoke are present see "To Broil" in the **Setting Oven Controls** section.

Oven control beeps & displays any F code error (for example F11; some models) - Electronic control has detected a fault condition. Press **CLEAR/OFF** to clear the display & stop beeping. Try the Bake or Broil function again. If the F code error repeats, remove power supply to appliance, wait 5 minutes and then repower the appliance and set clock time of day. Try the Bake or Broil function again. If the fault recurs, record fault number, press **CLEAR/OFF** & contact an authorized service agent.

Oven control beeps and displays any "F" code error (for example F3; some models) - Electronic control has detected a fault condition. Press **CLEAR/OFF** to clear the display & stop beeping. Reprogram oven. If fault recurs, record fault number. Press **CLEAR/OFF** & contact your authorized service agent.

Poor baking results - Many factors affect baking results. Make sure the proper oven rack position is used. Center food in the oven & space pans to allow air to circulate. Allow the oven to preheat to the set temperature before placing food in the oven. Try adjusting the recipe's recommended temperature or baking time. If you feel the oven is too hot or cool, see **Adjusting Your Oven Temperature** in this Use & Care Manual (some models).

Notes



Major Appliance Warranty Information

Your appliance is covered by a one year limited warranty. For one year from your original date of purchase, Electrolux will pay all costs for repairing or replacing any parts of this appliance that prove to be defective in materials or workmanship when such appliance is installed, used and maintained in accordance with the provided instructions.

Exclusions **This warranty does not cover the following:**

1. Products with original serial numbers that have been removed, altered or cannot be readily determined.
2. Product that has been transferred from its original owner to another party or removed outside the USA or Canada.
3. Rust on the interior or exterior of the unit.
4. Products purchased "as-is" are not covered by this warranty.
5. Food loss due to any refrigerator or freezer failures.
6. Products used in a commercial setting.
7. Service calls which do not involve malfunction or defects in materials or workmanship, or for appliances not in ordinary household use or used other than in accordance with the provided instructions.
8. Service calls to correct the installation of your appliance or to instruct you how to use your appliance.
9. Expenses for making the appliance accessible for servicing, such as removal of trim, cupboards, shelves, etc., which are not a part of the appliance when it is shipped from the factory.
10. Service calls to repair or replace appliance light bulbs, air filters, water filters, other consumables, or knobs, handles, or other cosmetic parts.
11. Surcharges including, but not limited to, any after hour, weekend, or holiday service calls, tolls, ferry trip charges, or mileage expense for service calls to remote areas, including the state of Alaska.
12. Damages to the finish of appliance or home incurred during installation, including but not limited to floors, cabinets, walls, etc.
13. Damages caused by: services performed by unauthorized service companies; use of parts other than genuine Electrolux parts or parts obtained from persons other than authorized service companies; or external causes such as abuse, misuse, inadequate power supply, accidents, fires, or acts of God.

DISCLAIMER OF IMPLIED WARRANTIES; LIMITATION OF REMEDIES

CUSTOMER'S SOLE AND EXCLUSIVE REMEDY UNDER THIS LIMITED WARRANTY SHALL BE PRODUCT REPAIR OR REPLACEMENT AS PROVIDED HEREIN. CLAIMS BASED ON IMPLIED WARRANTIES, INCLUDING WARRANTIES OF MERCHANTABILITY OR FITNESS FOR A PARTICULAR PURPOSE, ARE LIMITED TO ONE YEAR OR THE SHORTEST PERIOD ALLOWED BY LAW, BUT NOT LESS THAN ONE YEAR. ELECTROLUX SHALL NOT BE LIABLE FOR CONSEQUENTIAL OR INCIDENTAL DAMAGES SUCH AS PROPERTY DAMAGE AND INCIDENTAL EXPENSES RESULTING FROM ANY BREACH OF THIS WRITTEN LIMITED WARRANTY OR ANY IMPLIED WARRANTY. SOME STATES AND PROVINCES DO NOT ALLOW THE EXCLUSION OR LIMITATION OF INCIDENTAL OR CONSEQUENTIAL DAMAGES, OR LIMITATIONS ON THE DURATION OF IMPLIED WARRANTIES, SO THESE LIMITATIONS OR EXCLUSIONS MAY NOT APPLY TO YOU. THIS WRITTEN WARRANTY GIVES YOU SPECIFIC LEGAL RIGHTS. YOU MAY ALSO HAVE OTHER RIGHTS THAT VARY FROM STATE TO STATE.

If You Need Service

Keep your receipt, delivery slip, or some other appropriate payment record to establish the warranty period should service be required. If service is performed, it is in your best interest to obtain and keep all receipts. Service under this warranty must be obtained by contacting Electrolux at the addresses or phone numbers below.

This warranty only applies in the USA and Canada. In the USA, your appliance is warranted by Electrolux Major Appliances North America, a division of Electrolux Home Products, Inc. In Canada, your appliance is warranted by Electrolux Canada Corp. Electrolux authorizes no person to change or add to any obligations under this warranty. Obligations for service and parts under this warranty must be performed by Electrolux or an authorized service company. Product features or specifications as described or illustrated are subject to change without notice.

USA
1.800.944.9044
Electrolux Major Appliances
North America
P.O. Box 212378
Augusta, GA 30907



Canada
1.800.668.4606
Electrolux Canada Corp.
5855 Terry Fox Way
Mississauga, Ontario, Canada
L5V 3E4