

Installation Instructions

Microwave Oven

**Read carefully.
Keep these Instructions.**

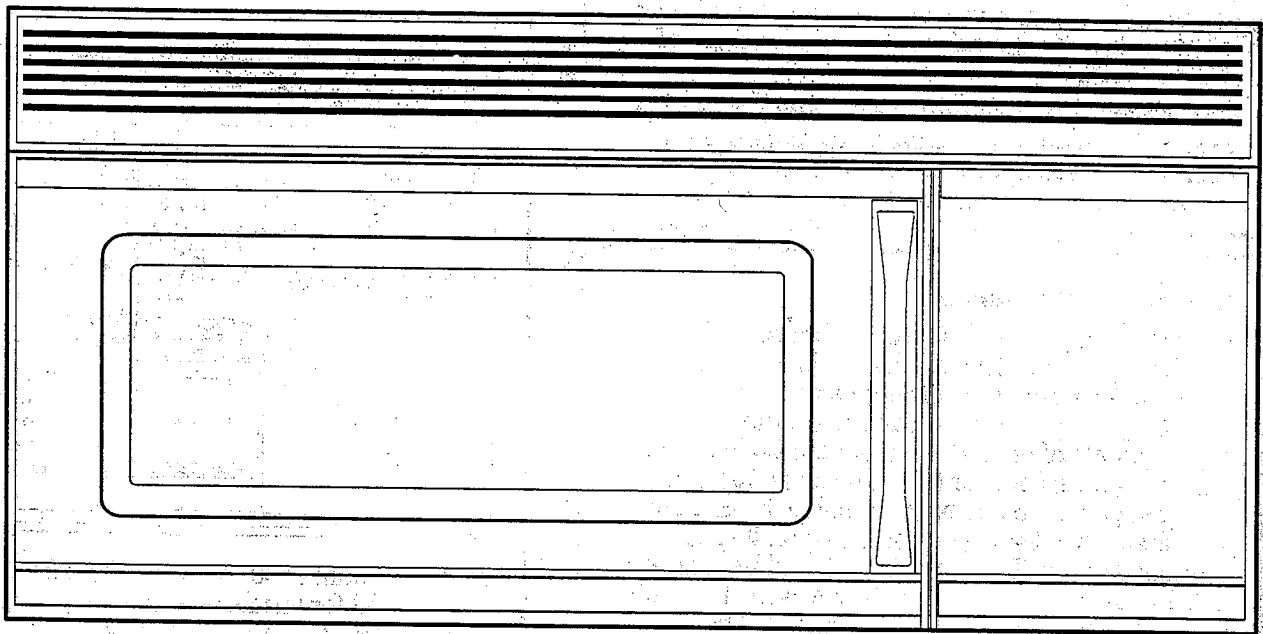

5304409004

INSTALLATION INSTRUCTIONS

I REQUIREMENTS FOR INSTALLATION

Important Safety Instructions

This product requires a three-prong grounded outlet. The installer must perform a ground continuity check on the power outlet box before beginning the installation to insure that the outlet box is properly grounded. If not properly grounded, or if the outlet box does not meet electrical requirements noted (under ELECTRICAL REQUIREMENTS), a qualified electrician should be employed to correct any deficiencies.

CAUTION: For personal safety, remove house fuse or open circuit breaker before beginning installation to avoid severe or fatal shock injury.

CAUTION: For personal safety, the mounting surface must be capable of supporting the cabinet load, in addition to the added weight of this 63 pound product, plus additional oven loads of up to 50 pounds or a total weight of 113 pounds.

CAUTION: For personal safety, this product cannot be installed in cabinet arrangements such as an island or a peninsula. It must be mounted to both a top cabinet and a wall.

Electrical Requirements

Product rating is 120 volts AC, 60 Hertz, 15 amps, and 1.58 kilowatts. This product must be connected to a supply circuit of the proper voltage and frequency. Wire size must conform to the requirements of the National Electric Code or the prevailing local code for this kilowatt rating. The power supply cord and plug should be brought to a separate 15 to 20 ampere branch circuit single grounded outlet. The outlet box should be located in the cabinet above the microwave oven. The outlet box and supply circuit should be installed by a qualified electrician and conform to the National Electric Code or the prevailing local code.

NOTE: For easier installation and personal safety, it is recommended that two people install this product.

IMPORTANT—PLEASE READ CAREFULLY. FOR PERSONAL SAFETY, THIS APPLIANCE MUST BE PROPERLY GROUNDED TO AVOID SEVERE OR FATAL SHOCK.

The power cord of this appliance is equipped with a three-prong (grounding) plug which mates with a standard three-prong (grounding) wall receptacle (Fig. 1) to minimize the possibility of electric shock hazard from this appliance.

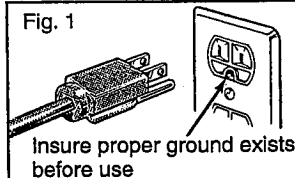

You should have the wall receptacle and circuit checked by a qualified electrician to make sure the receptacle is properly grounded.

Where a standard two-prong wall receptacle is encountered, it is very important to have it replaced with a properly grounded three-prong wall receptacle, installed by a qualified electrician.

DO NOT, UNDER ANY CIRCUMSTANCES, CUT, DEFORM, OR REMOVE ANY OF THE PRONGS FROM THE POWER CORD. DO NOT USE WITH AN EXTENSION CORD.

Mounting Space

This section describes the space you need to install your microwave oven.

Your Over-the-Range microwave oven requires mounting space on a wall as shown.

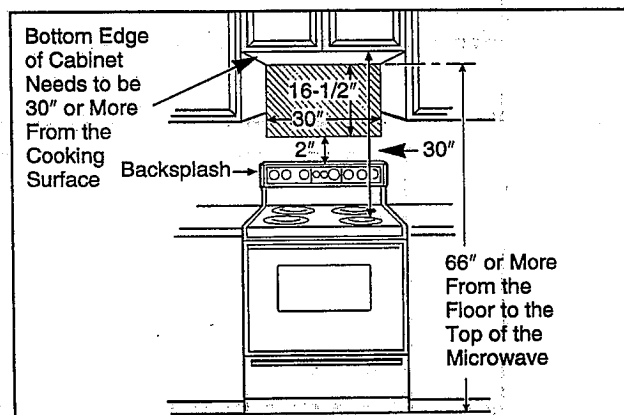

1. A minimum of 30" between the cabinets is required for installation. If the space between the cabinets is greater than 30", a Filler Panel Kit may be used to fill in the gap between the microwave oven and the cabinets. Your Owner's Manual contains the kit number for your model.
2. Make sure the bottom edge of the cabinet that will be above the microwave oven is at least 66" from the floor and 30" from the cooking surface.
3. For easier access to change the hood and range lamps, the bottom of the microwave oven should be at least 2" above the range backsplash.
4. If you are going to vent your microwave oven to the outside, see Section 5 for exhaust duct preparation.
5. When installing the microwave oven beneath smooth, flat cabinets, be careful to follow the instructions on the top cabinet template for power cord clearance.



OVERVIEW OF INSTALLATION PROCEDURE

This section gives a brief overview of what you need to do to install this microwave. Read these entire instructions before you begin installation.

Before you install this microwave, remove the adhesive tape, if there is any, on the exhaust adaptor, grease filters and power supply cord.

1. Install an outlet and make sure you meet the electrical requirements for this installation.
2. Open the installation hardware packet. Compare it to the hardware list to make sure you have all the parts.
3. Remove the mounting plate.
4. Check the microwave exhaust duct and change it if required.
5. Attach the mounting plate to the wall.

Your cabinets may have trim that interferes with the microwave installation. You may need to remove the trim in order to fit the microwave in and to make it level.

The space must be 30" wide. Remove any cabinet side trim that interferes with the 30" space, front or back.

THE MICROWAVE MUST BE LEVEL.

If the cabinets have top trim (front, back or both), this can be left in place if there is still enough clearance for proper installation.

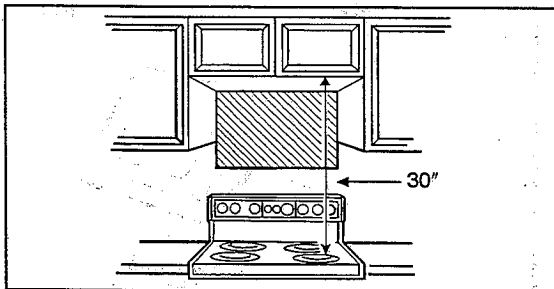

If you leave the top front trim on, and there is no back trim, make sure the mounting plate is positioned down far enough to keep the microwave level. Keep the space between the bottom of the cabinet and the mounting plate equal to the height of the top front trim. This will insure level installation of the microwave.

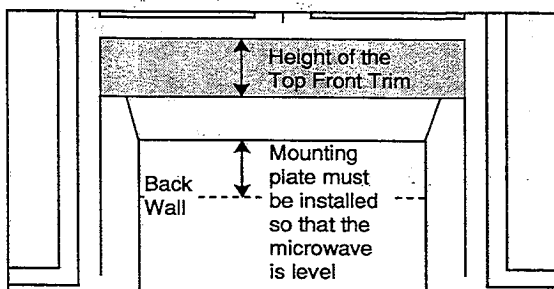

6. Hook the slots at the back bottom edge of the microwave onto the 4 lower tabs of the mounting plate and rotate it up.
7. Attach the microwave oven to the top cabinet.

TOOLS YOU WILL NEED

- Phillips screwdriver
- Pencil
- Ruler or tape measure and straight edge
- Carpenter square (optional)
- Tin snips (in some applications)
- Electric drill with 3/16", 1/2" and 5/8" drill bits
- Hammer
- Stud finder (optional)
- Filler blocks, if needed for top cabinet spacing
- Gloves
- Saw (jig or keyhole)

2 PARTS INCLUDED

You will find the installation hardware contained in a packet with the unit. Check to make sure you have all these parts. The installation hardware (1-5) should include the following:

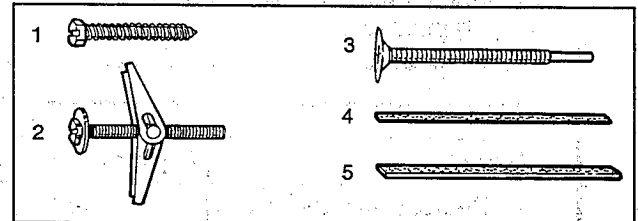

Hardware List

(some extra parts are included)

	Quantity
1. Wood Screws (1/4" x 2")	2
2. Toggle Bolts (and wing nuts) 3/16" x 3"	4
3. Self-aligning Machine Screws (1/4" x 3 1/4")	3
4. Nylon Grommet (for metal cabinets)	2
5. 28" Piece of Foam Tape	2

In addition you will need:

Top Cabinet Template	1
Installation Instructions	1
Separately Packed Grease Filters	2



INSTALLATION INSTRUCTIONS

(continued)

3 HOOD EXHAUST DUCT

Outside ventilation requires a HOOD EXHAUST DUCT. Read the following carefully.

EXHAUST CONNECTION: The hood exhaust has been designed to mate with a standard 3 1/4" x 10" rectangular duct.

If a round duct is required, a rectangular-to-round transition adaptor must be used. Do not use less than a 6" diameter duct.

REAR EXHAUST: If a rear or horizontal exhaust is to be used, care should be taken to align exhaust with space between studs, or wall should be prepared at the time it is constructed by leaving enough space between the wall studs to accommodate exhaust.

MAXIMUM DUCT LENGTH: For satisfactory air movement, the total duct length of 3 1/4" x 10" rectangular or 6" diameter round duct should not exceed 140 equivalent feet.

ELBOWS, TRANSITIONS, WALL AND ROOF CAPS, etc., present additional resistance to airflow and are equivalent to a section of straight duct which is longer than their actual physical size. When calculating the total duct length, add the equivalent lengths of all transitions and adaptors plus the length of all straight duct sections. The chart below shows the approximate feet of equivalent length of some typical ducts.

Duct	Equivalent Length
A. Rectangular-to-Round Transition Adaptor	5 Ft.
B. Wall Cap	40 Ft.
C. 90° Elbow	10 Ft.
D. 45° Elbow	5 Ft.
E. 90° Elbow	25 Ft.
F. 45° Elbow	5 Ft.
G. Roof Cap	24 Ft.

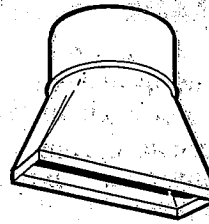

A. Rectangular-to-Round Transition Adaptor
5 Ft.*

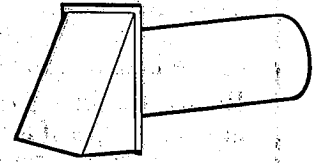

B. Wall Cap
40 Ft.

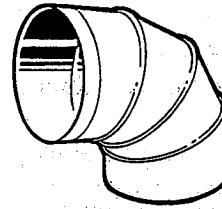

C. 90° Elbow
10 Ft.

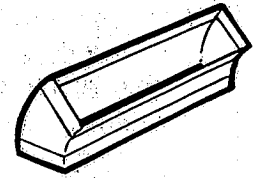

D. 45° Elbow
5 Ft.

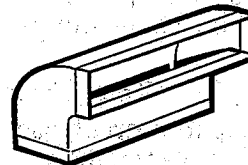

E. 90° Elbow
25 Ft.

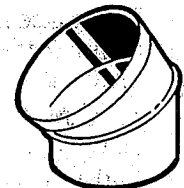

F. 45° Elbow
5 Ft.

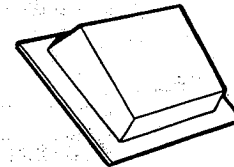

G. Roof Cap
24 Ft.

* If a rectangular-to-round transition adaptor is used, the bottom corners of the damper will have to be cut to fit, using the tin snips, in order to allow free movement of the damper.

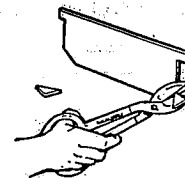



4 REMOVE THE MOUNTING PLATE

The mounting plate comes attached to the back of the microwave oven.

1. Stand the microwave on its control panel side. Use a portion of the carton or some other material to protect the outer case from being damaged.

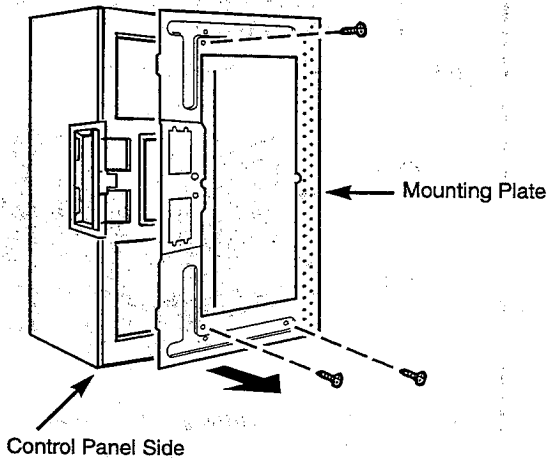
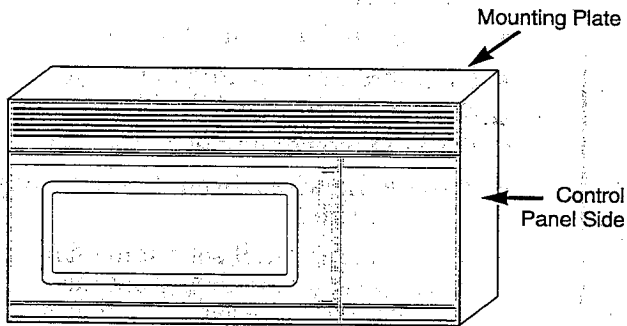

2. Remove the 3 screws from the mounting plate as shown.
3. This plate will be used as the rear wall template.
4. Locate exhaust adaptor, grease filters and hardware packet.
5. At this point, remove any adhesive tape (if there is any), on the exhaust adaptor, the grease filters and the power supply cord.

5 MICROWAVE EXHAUST DUCT

This microwave oven is designed for adaptation to the following three types of ventilation.

NOTE: This microwave is shipped assembled for top exhaust (except for non-vented models). Select the type of ventilation required for your installation and proceed to that section.

- A. Outside Top Exhaust (Vertical Duct)
- B. Outside Back Exhaust (Horizontal Duct)
- C. Recirculating (Non-Vented Ductless)

A Charcoal Filter Accessory Kit is required for the non-vented exhaust. (See your Use and Care Guide for the kit number.)

ADAPTING MICROWAVE BLOWER

A. OUTSIDE TOP EXHAUST (Vertical)

This microwave oven is shipped assembled for top exhaust. However, you will need to make adjustments to assure proper alignment with your current exhaust duct after the microwave is installed.

1. To install or remove the exhaust adaptor from blower plate you need to first remove the damper (on flat bottom cabinets only).
 - Pull the damper up.
 - Squeeze the diagonal corners to allow the damper to be removed.
 - Slide the exhaust adaptor to one side, squeeze the sides and take it out.

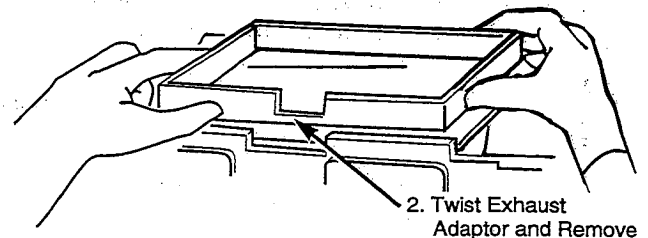
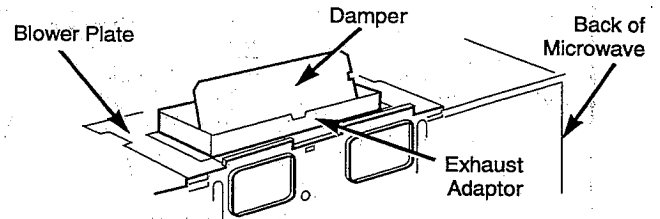

Save the damper and exhaust adaptor for later replacement.

2. Proceed to PREPARATION OF TOP CABINET.



INSTALLATION INSTRUCTIONS

(continued)

5 MICROWAVE EXHAUST DUCT (continued)

B. OUTSIDE BACK EXHAUST (Horizontal Duct)

This microwave oven is shipped assembled for top exhaust. However, you will need to make adjustments to assure proper alignment with your current exhaust duct after the microwave is installed.

- To install or remove the exhaust adaptor from blower plate you need to first remove the damper.
 - Pull the damper up.
 - Squeeze the diagonal corners to allow the damper to be removed.
 - Slide the exhaust adaptor to one side, squeeze the sides and take it out.

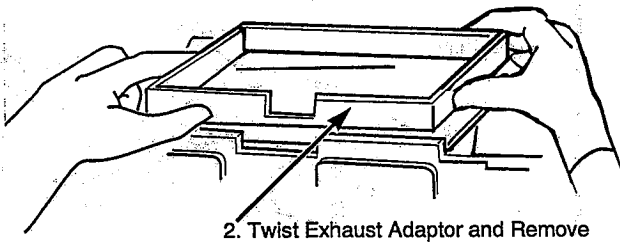
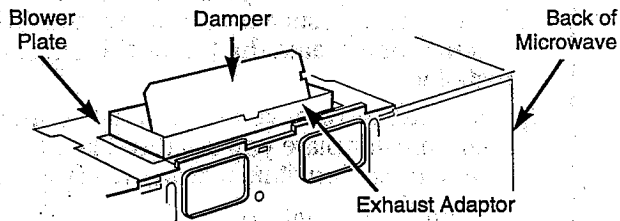

Save the damper and exhaust adaptor for later replacement.

- Remove and save the screw that holds the blower plate to the microwave.

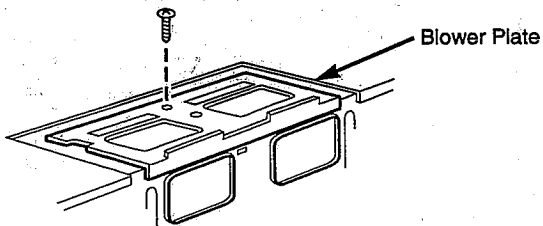

- Lift off the blower plate.
 - Remove and save the screw that holds the blower motor to the microwave.

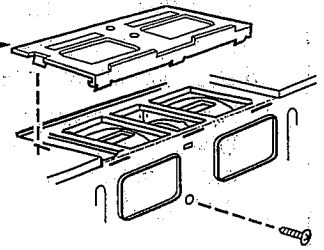

- Carefully pull out the blower unit.
 - The wires will extend far enough to allow you to adjust the blower unit.
 - Turn the blower unit end-over-end.
 - Reroute the wires through the grooves on the other side.
 - Roll the blower unit so that the fan blade openings are facing out the back of the microwave. The blower unit exhaust openings should match the exhaust openings on the rear of the microwave oven.

BEFORE: Fan Blade Openings Facing Up

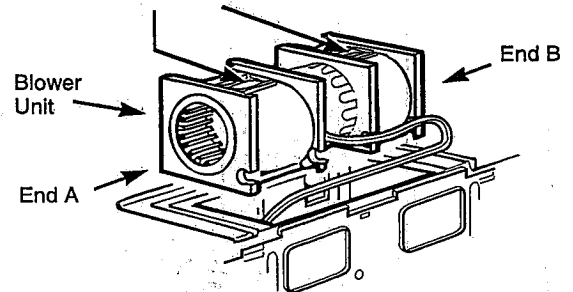

AFTER: Fan Blade Openings Facing Back





- The wires should be routed in the grooves of the motor frame.

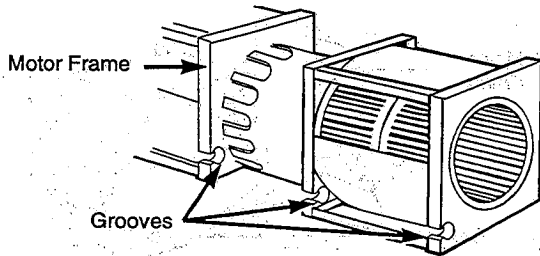

5. • Guide the wires into the duct as you place the blower unit back into the opening.
 - Secure the blower unit to the microwave with the screw from Step 3.

CAUTION: Do not pull or stretch the blower unit wiring. **Make sure the wires are not pinched.**

6. Replace the blower plate in the same position as before with the screw.

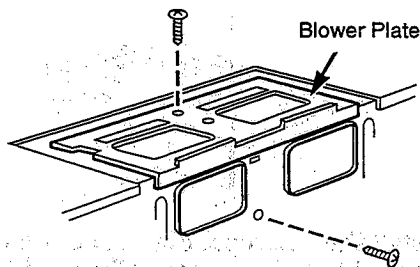

7. Replace the damper back into the exhaust adaptor.

8. Fit the exhaust adaptor into the house duct. Be sure that the damper hinge is on the top and the damper swings free into the wall outlet.

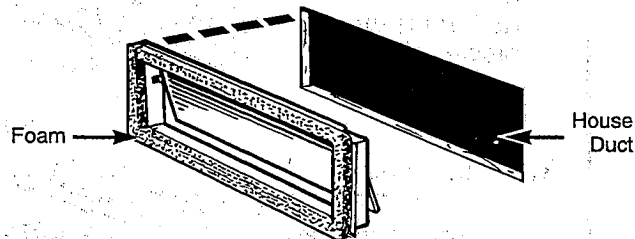

9. Take one of the 28" foam tapes and remove the paper from the sticky side. Press the sticky side onto the front edge of the exhaust adaptor. (Don't stretch the foam tape.)

10. Proceed to PREPARATION OF THE TOP CABINET.

C. RECIRCULATION (Non-Vented, Ductless)

NOTE: The exhaust adaptor with damper is not needed for recirculating models. You may want to save them for possible future use. (You must use the Charcoal Filter Kit. See your Owner's Manual for kit number.)

1. To install or remove the exhaust adaptor from blower plate, you need to first remove the damper.

- Pull the damper up.
- Squeeze the diagonal corners to allow the damper to be removed.
- Slide the exhaust adaptor to one side, squeeze the sides and take it out.

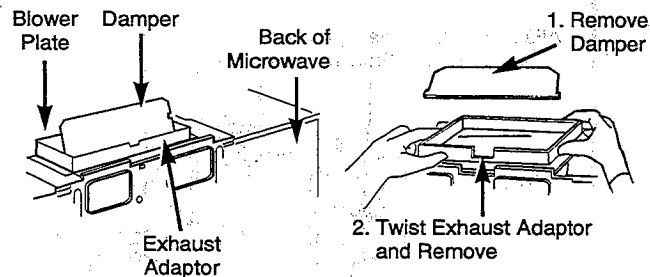

(continued next page)

INSTALLATION INSTRUCTIONS

(continued)

5 MICROWAVE EXHAUST DUCT (continued)

2. Remove and save the screw that holds the blower plate to the microwave.

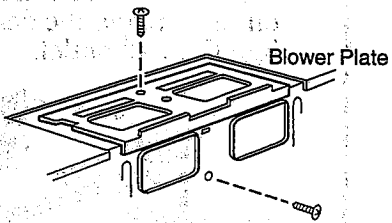

3. • Lift off the blower plate.
• Remove and save the screw that holds the blower motor to the microwave.

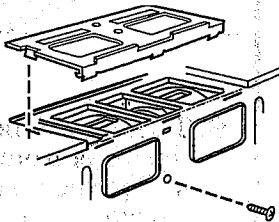

4. Carefully pull out the blower unit. The wires will extend far enough to allow you to adjust the blower unit.

- Roll the blower unit so that the fan blades are facing towards the front of the microwave.

BEFORE: Fan Blades are Facing Up

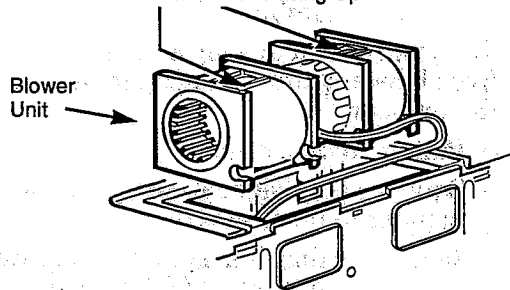

AFTER: Fan Blade Openings Facing Front of Microwave

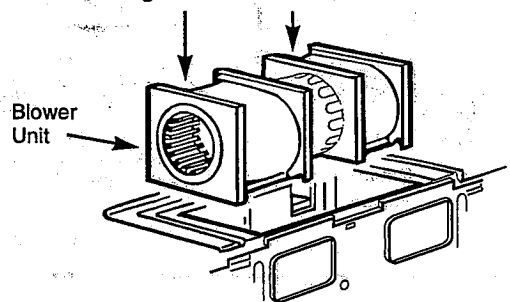

- The wires should be routed in the grooves of the motor frame.

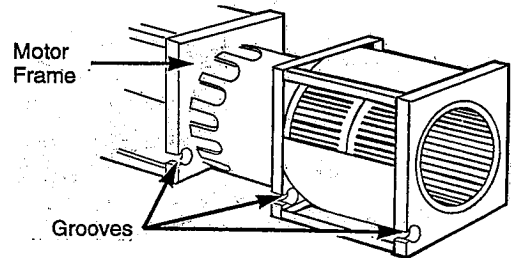

5. • Guide the wires into the duct as you place the blower unit back into the opening.
• Secure the blower motor to the microwave with the screw from Step 3.

CAUTION: Do not pull or stretch blower unit wiring. Make sure wires are not pinched.

6. Replace the blower plate in the same position as before with the screws.

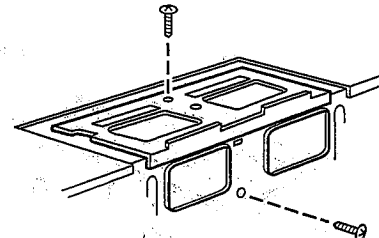

7. Install the Charcoal Filter. See the Owner's Manual or below for the Charcoal Filter Accessory Kit needed for this model.

- Remove the 2 screws on the front of the grille and remove the grille.
- Install the charcoal filter.
- Replace the grille and 2 screws.

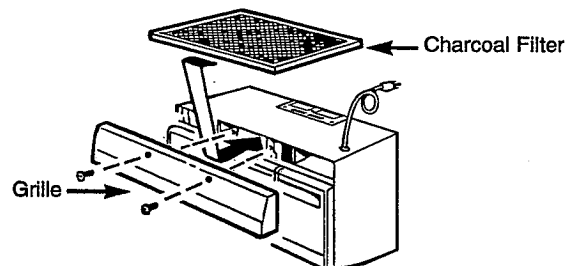

8. Proceed to PREPARATION OF TOP CABINET.

IMPORTANT—When installing the exhaust blower in recirculation position, use Charcoal Filter Accessory Kit available from your appliance dealer.



6 PREPARATION OF TOP CABINET

You need to drill holes for the top support screws and a hole large enough for the power cord to fit through.

- Read the instructions on the top cabinet template.
- Tape it underneath the top cabinet.
- Drill the holes, following the instructions on the template.

7 ATTACH THE MOUNTING PLATE TO THE WALL

Your microwave oven needs to be mounted against and supported by a flat, vertical wall. Wall construction should be a minimum of 2" x 4" wall studding and 3/8" or more thick drywall or plaster/lath. The oven must be attached to a minimum of one 2" x 4" wall stud.

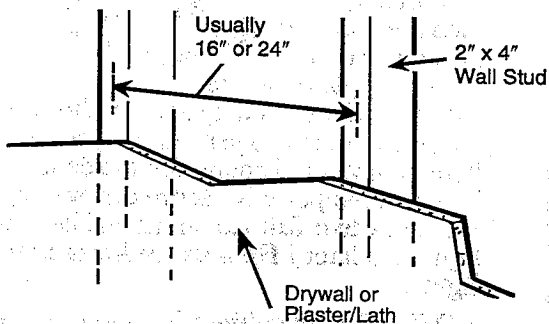

1. Find the studs, using one of the following methods:
 - A. Stud finder—a magnetic device which locates nails.
 - B. Use a hammer to tap lightly across the mounting surface to find a solid sound. This will indicate a stud installation.

After locating the stud(s), the center can be found by probing the wall with a small nail to find the edges of the stud and then placing a mark halfway between the edges. The center of any adjacent studs should be 16" or 24" from this mark.

2. Draw a line down the middle of the studs.

THE MICROWAVE MUST BE CONNECTED TO AT LEAST ONE WALL STUD.

3. Draw a vertical line on the wall at the center of the 30" wide space.

Use the mounting plate as the **template** for the rear wall. Place the mounting plate on the wall, making sure that the tabs are against the bottom of the cabinet. Line up the notch and center line on the mounting plate to the center line on the wall.

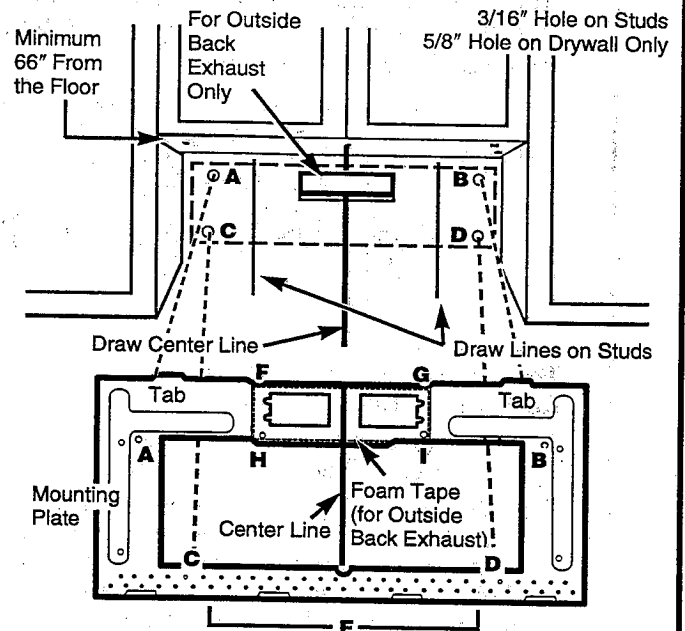

4. While holding the mounting plate with one hand, draw circles on the wall at holes A, B, C and D. **Four holes must be used for mounting. If the holes are not used, the installation will not be secure. Installer must use these holes for proper installation.** Use toggle bolts through these holes unless one of them lines up with a stud. Use a wood screw for studs.

NOTE: Draw a fifth circle inside area E, through one of the **bottom** holes to match the location of a stud.

For outside back exhaust: The microwave requires a rear wall cutout opening for the rear wall duct. See the next page on how to prepare the rear wall cutout opening for outside back exhaust.

Set the mounting plate aside.

5. Drill holes on the circles. If there is a stud, drill a 3/16" hole for wood screws. If there is **no** stud, drill a 5/8" hole for toggle bolts. **Make sure to use at least 1 wood screw in a stud, and 4 toggle bolts in the drywall or the plaster.**

INSTALLATION INSTRUCTIONS

(continued)

7 ATTACH THE MOUNTING PLATE TO THE WALL (continued)

6. Attach the plate to the wall. To use toggle bolts: Remove the toggle wings from the bolts. Insert the bolts into the mounting plate and replace the toggle wings to 3/4" past the bolt ends. Insert the toggle wings into the holes in the wall to mount the bracket. You may pull forward on the bracket to help in tightening the toggle bolts. Tighten all bolts.

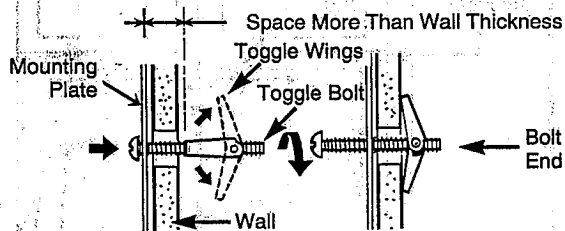

To prepare the rear wall cutout opening for outside back exhaust:

1. Place the mounting plate against the rear wall as described in Step 7, item 3.
2. Using a pencil, put dots through holes F, G, H and I. Remove the mounting plate and draw lines extending through the points. This will give the location and size of the box cutout for the rear wall duct.

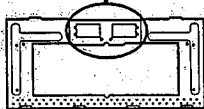
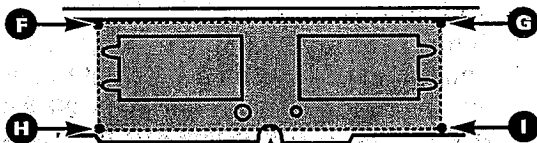

- Make sure the exhaust adaptor (with the damper) is squared up in the house duct and lines up with the holes in the mounting plate.

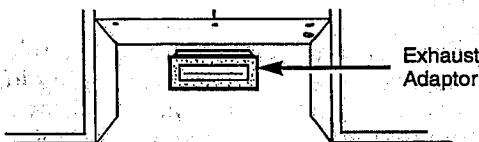

- Attach the 28" foam tape to the front of the mounting plate around both of the exhaust openings where it will touch the microwave.

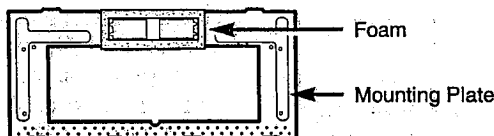

8 MOUNT THE MICROWAVE OVEN

FOR EASIER INSTALLATION AND PERSONAL SAFETY, WE RECOMMEND THAT TWO PEOPLE INSTALL THIS MICROWAVE OVEN.

IMPORTANT: Do not grip or use handle during installation.

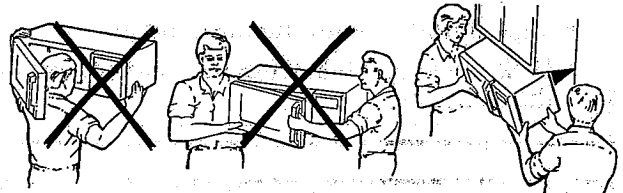

1. Locate the grease filters packed separately and set aside. Thread the power cord through the hole in the bottom of the top cabinet. Keep the cord tight throughout Step 2.

2. Install the microwave by hooking the slots at the back bottom edge onto the four lower tabs of the mounting plate. Rotate the front of the oven up against the cabinet bottom and using a self-aligning screw (hardware item 3) insert it through the top center cabinet hole and temporarily secure the oven by turning the screw two full turns. (It will be completely tightened later.) Be sure to keep power cord tight.

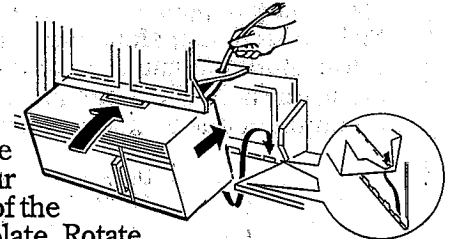

NOTE: If your cabinet is metal, use the nylon grommet around the power cord hole to prevent cutting of the cord.

3. Attach the microwave oven to the top cabinet.

NOTE: You'll need to use a filler block if the cabinet front hangs below the cabinet bottom shelf.

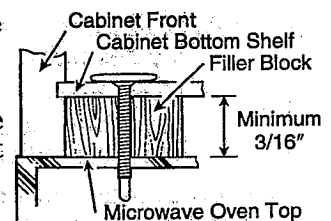

Insert 2 self-aligning screws (hardware item 3) through the outer top cabinet holes. Tighten the center screw completely and then the outer two screws to the top of the microwave oven. (While tightening screws, lift the front side of the microwave and push toward the wall.)

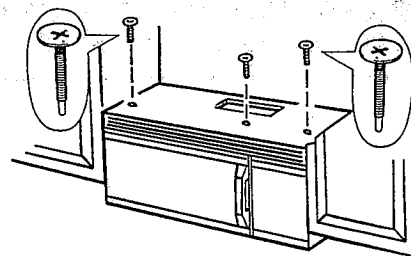



4. Install the grease filters and remove the tape from the cooktop lamp cover on the bottom of the oven.
5. For top exhaust open the top cabinet and attach the exhaust adaptor to the microwave through the cabinet bottom. For front-to-back or side-to-side adjustment, slide the exhaust adaptor as needed.

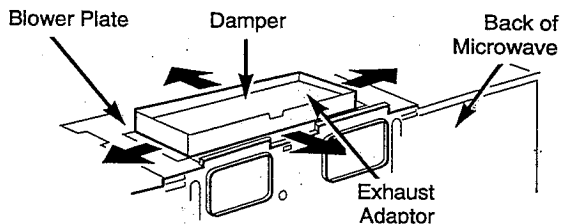

If you previously removed the exhaust adaptor: With the damper out, twist the exhaust adaptor to fit under the flaps of the blower plate. Replace the damper and make sure it will move easily by the force of the exhaust air. Be sure to square the corners on the hinge ends.

Replace the Damper After the Exhaust Adaptor is in Place
(Make sure the damper moves freely.)

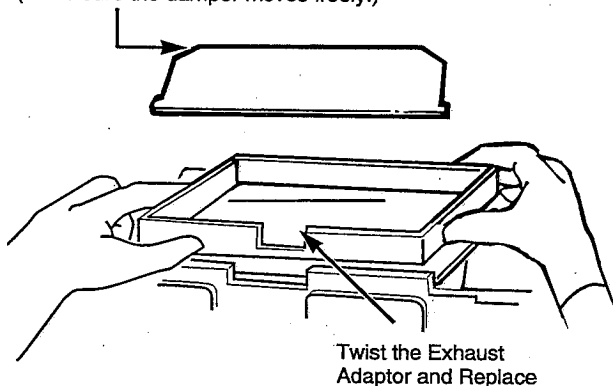

Pull the house duct down to connect to the exhaust adaptor. Tape duct using duct tape.

9 INSTALLATION CHECKLIST

1. Make sure the microwave has been installed according to instructions.
2. Remove all packing material from the microwave oven.
3. Replace house fuse or turn breaker back on.
4. Plug power cord into outlet.
5. Read the Owner's Manual.
6. KEEP INSTALLATION INSTRUCTIONS FOR THE LOCAL INSPECTOR'S USE.

1. The first part of the document is a list of names and titles of the members of the committee. The names are listed in alphabetical order and include the following: [Illegible names and titles]

The second part of the document is a report on the work of the committee during the year. It begins with a statement of the committee's purpose and objectives. The report then discusses the various activities and projects that were carried out during the year. It also includes a section on the committee's financial affairs and a final section on its conclusions and recommendations. The report is signed by the Chairman of the committee and is dated [Illegible date].

Part No. 164D3370P036
Pub. No. 49-40036-4

Printed in the United States