

Gas Range

*Sealed Surface Burners,
Electronic Oven Control,
and a Self-Cleaning Oven Interior*

 **FRIGIDAIRE**

Owner's Guide

Product Registration	2
Versión en español	2
Versión française	2
IMPORTANT SAFETY INSTRUCTIONS ..	3-4
Grounding Instructions	4
Control Pad Functions	5
Setting the Clock and Minute Timer	6
Flame Size	7
Proper Burner Adjustments	7
Setting Surface Controls	7
Setting Warmer Drawer Controls (if equipped)	8
Before Setting Oven Controls	9
Setting Oven Controls	9-11
Oven Cleaning	12-13
General Cleaning	14-16
Changing Oven Light (some models)	17
Adjusting Oven Temperature	17
Avoid Service Checklist	18-19
Warranty	Back Page

the *LOOK* of better performance

Product Registration

Register Your Product

The self-addressed **PRODUCT REGISTRATION CARD** should be filled in completely, signed and returned to Frigidaire Home Products.

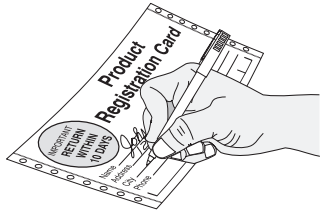

Versión en español

Si desea obtener una copia en español de este Manual del Usuario, sírvase escribir a la dirección que se incluye a continuación. Solicite la P/N316000295S.

Version française

Si vous désirez obtenir un exemplaire de la version française de ce "Guide de l'utilisateur," faites-en la demande par écrit à l'adresse indiquée ci-dessous. Exigez qu'on vous livre le N° de pièce 316000295F.

French Owner's Guides **-OR-**
Spanish Owner's Guides (please specify)
Frigidaire Company
P. O. Box 9061
Dublin, Ohio 43017-0961

Thank you for choosing this appliance. The information contained within this **Owner's Guide** will instruct you on how to properly operate and care for your range. Please read through the information contained in your literature pack to learn more about your new appliance.

Record Your Model and Serial Numbers

Record in the space provided below the model and serial numbers found on the right side of the oven front frame in the storage compartment or on the oven floor shield.

Model Number: _____

Serial Number: _____

Date of Purchase: _____

This Owner's Guide contains general operating instructions for your range and feature information for several models. Your range **may not** have all the described features.

Note: The instructions appearing in this Owner's Guide are not meant to cover every possible condition and situation that may occur. Common sense and caution must be practiced when installing, operating and maintaining any appliance.



⚠ WARNING If the information in this manual is not followed exactly, a fire or explosion may result causing property damage, personal injury or death.

FOR YOUR SAFETY:

- Do not store or use gasoline or other flammable vapors and liquids in the vicinity of this or any other appliance.
- **WHAT TO DO IF YOU SMELL GAS:**
 - Do not try to light any appliance.
 - Do not touch any electrical switch; do not use any phone in your building.
 - Immediately call your gas supplier from a neighbor's phone. Follow the gas supplier's instructions.
 - If you cannot reach your gas supplier, call the fire department.
- Installation and service must be performed by a qualified installer, servicer or the gas supplier.

IMPORTANT SAFETY INSTRUCTIONS

Read all instructions before using this appliance.

Save these instructions for future reference.

This guide contains important safety symbols and instructions. Please pay attention to these symbols and follow all instructions given. Here is a brief explanation of the use of these symbols.

⚠ WARNING This symbol will help alert you to situations that may cause serious bodily harm, death or property damage.

⚠ CAUTION This symbol will help alert you to situations that may cause bodily injury or property damage.

- **Remove all tape and packaging before using the range.** Destroy the carton and plastic bags after unpacking the range. Never allow children to play with packaging material.
- **Proper Installation—Be sure your appliance is properly installed and grounded by a qualified technician in accordance with the National Fuel Gas Code ANSI Z223.—latest edition, or in Canada CAN/CGA B149.1, and CAN/CGA B149.2, and the National Electrical Code ANSI/NFPA No. 70—latest edition, or in Canada CSA Standard C22.1, Canadian Electrical Code Part 1, and local code requirements.** Install only per installation instructions provided in the literature package for this range. Ask your dealer to recommend a qualified technician and an authorized repair service. Know how to disconnect the power to the range at the circuit breaker or fuse box in case of an emergency.
- **User servicing—Do not repair or replace any part of the appliance unless specifically recommended in the manuals.** All other servicing should be done only by a qualified technician. This may reduce the risk of personal injury and damage to the range.
- **Never modify or alter the construction of a range by removing leveling legs, panels, wire covers, anti-tip brackets/screws, or any other part of the product.**

⚠ WARNING

- All ranges can tip.
- Injury to persons could result.
- Install anti-tip device packed with range.
- See Installation Instructions.



⚠ WARNING To reduce the risk of tipping, the range must be secured by properly installed anti-tip bracket provide with the range. To check if the bracket is installed properly, visually check that rear leveling leg is inserted into and fully secured by the anti-tip bracket by removing lower panel or storage drawer. For models with a warmer drawer, grasp the top rear edge of the range and carefully attempt to tilt it forward. Refer to the Installation Instructions for proper anti-tip bracket installation.



⚠ WARNING Stepping, leaning or sitting on the doors or drawers of this range can result in serious injuries and also cause damage to the range. Do not allow children to climb or play around the range. The weight of a child on an open door may cause the range to tip, resulting in serious burns or other injury.

⚠ WARNING Do not use the oven, broiler compartment or warmer drawer for storage.

⚠ CAUTION Do not store items of interest to children in the cabinets above a range or on the backguard of a range. Children climbing on the range to reach items could be seriously injured.

⚠ WARNING Never Use Your Appliance for Warming or Heating the Room.

- **Storage in or on Appliance—Flammable materials should not be stored in an oven, warmer drawer, broiler compartment, near surface burners, broiler compartment or in the storage drawer.** This includes paper, plastic and cloth items, such as cookbooks, plasticware and towels, as well as flammable liquids. Do not store explosives, such as aerosol cans, on or near the range.
- **Do Not Leave Children Alone—Children should not be left alone or unattended in the area where appliance is in use.** They should never be allowed to sit or stand on any part of the appliance.
- **DO NOT TOUCH SURFACE BURNERS, AREAS NEAR THESE BURNERS, OVEN BURNERS OR INTERIOR SURFACES OF THE OVEN.** Both surface and oven burners may be hot even though flames are not visible. Areas near surface burners may become hot enough to cause burns. During and after use, do not touch, or let clothing or other flammable materials touch these areas until they have had sufficient time to cool. Among these areas are the cooktop, surfaces facing the cooktop, the oven vent openings and surfaces near these openings, oven door and window.
- **Wear Proper Apparel—Loose-fitting or hanging garments should never be worn while using the appliance.** Do not let clothing or other flammable materials contact hot surfaces.
- **Do Not Use Water or Flour on Grease Fires—Smother the fire with a pan lid, or use baking soda, a dry chemical or foam-type extinguisher.**
- **When heating fat or grease, watch it closely.** Fat or grease may catch fire if allowed to become too hot.
- **Use Only Dry Potholders—Moist or damp potholders on hot surfaces may result in burns from steam.** Do not let potholders touch hot heating elements. Do not use a towel or other bulky cloth instead of a potholder.
- **Do Not Heat Unopened Food Containers—Buildup of pressure may cause container to burst and result in injury.**
- **Remove the oven door from any unused range if it is to be stored or discarded.**

IMPORTANT—Do not attempt to operate the oven during a power failure. If the power fails, always turn off the oven. If the oven is not turned off and the power resumes, the oven will begin to operate again. Once the power resumes, reset the clock and oven function.

IMPORTANT SAFETY INSTRUCTIONS

IMPORTANT INSTRUCTIONS FOR USING YOUR COOKTOP

⚠ WARNING Use Proper Flame Size—Adjust flame size so it does not extend beyond the edge of the utensil. The use of undersized utensils will expose a portion of the burner flame to direct contact and may result in ignition of clothing. Proper relationship of utensil to flame will also improve efficiency.

- **Know which knob controls each surface burner.** Place a pan of food on the burner before turning it on, and turn the burner off before removing the pan.
- **Always turn knob to the full LITE position when igniting top burners.** Visually check that burner has lit. Then adjust the flame so it does not extend beyond the edge of the utensil.
- **Utensil Handles Should Be Turned Inward and Not Extend Over Adjacent Surface Burners**—To reduce the risk of burns, ignition of flammable materials, and spillage due to unintentional contact with the utensil, the handle of the utensil should be positioned so that it is turned inward, and does not extend over adjacent surface burners.
- **Never Leave Surface Burners Unattended at High Heat Settings**—Boilovers cause smoking and greasy spillovers that may ignite, or a pan that has boiled dry may melt.
- **Protective Liners**—Do not use aluminum foil to line surface burner pans, or oven bottom, except as suggested in this manual. Improper installation of these liners may result in risk of electric shock, or fire.
- **Glazed Cooking Utensils**—Only certain types of glass, glass/ceramic, ceramic, earthenware, or other glazed utensils are suitable for cooktop service without breaking due to the sudden change in temperature. Check the manufacturer's recommendations for cooktop use.

IMPORTANT INSTRUCTIONS FOR USING YOUR OVEN

- **Use Care When Opening Oven Door or Warmer Drawer**—Stand to the side of the range when opening the door of a hot oven. Let hot air or steam escape before you remove or replace food in the oven.

Grounding Instructions

(electric ignition models only)

⚠ WARNING Avoid fire hazard or electrical shock. Do not use an adapter plug, an extension cord, or remove grounding prong from electrical power cord. Failure to follow this warning can cause serious injury, fire or death.

⚠ WARNING This appliance is equipped with a 3-prong grounding plug for your protection against shock hazard and should be plugged directly into a properly grounded receptacle. **DO NOT** cut or remove the grounding prong from this plug.

For personal safety, the range must be properly grounded. For maximum safety, the power cord must be plugged into an electrical outlet that is correctly polarized and properly grounded.

DO NOT Operate the range using a 2-prong adapter or an extension cord. If a 2-prong wall receptacle is the only available outlet, it is the personal responsibility of the consumer to have it replaced with a properly grounded 3-prong wall receptacle installed by a qualified electrician.

See the **INSTALLATION INSTRUCTIONS** packaged with this range for complete installation and grounding instructions.

- **Keep Oven Vent Ducts Unobstructed.** The oven vent is located below the backguard. Touching the surfaces in this area when the oven is operating may cause severe burns. Also, do not place plastic or heat-sensitive items on or near the oven vent. These items could melt or ignite.
- **Placement of Oven Racks.** Always place oven racks in desired location while oven is cool. If rack must be moved while oven is hot use extreme caution. Use potholders and grasp the rack with both hands to reposition. Do not let potholders contact the hot heating elements in the oven. Remove all utensils from the rack before moving.
- **Do not use the broiler pan without its insert.** The broiler pan and its insert allow dripping fat to drain and be kept away from the high heat of the broiler.
- **Do not cover the broiler insert with aluminum foil. Exposed fat and grease could ignite.**
- Cold temperatures can damage the electronic control. When using the appliance for the first time, or when the appliance has not been used for an extended period of time, be certain the unit has been in temperatures above 32°F (0°C) for at least 3 hours before turning on the power to the appliance.

IMPORTANT INSTRUCTIONS FOR CLEANING YOUR RANGE

- **Clean the range regularly to keep all parts free of grease that could catch fire.** Pay particular attention to the area underneath each surface element. Do not allow grease to accumulate. Refer to the hood manufacturer's instructions for cleaning.
- **Kitchen cleaners and aerosols**—Always follow the manufacturer's recommended directions for use. Be aware that excess residue from cleaners and aerosols may ignite causing damage and injury.

SELF CLEANING OVENS

- **Clean in the self-cleaning cycle only the parts listed in this Owner's Guide.** Before self cleaning the oven, remove the broiler pan and any utensils or foods from the oven.
- **Do Not Use Oven Cleaners**—No commercial oven cleaner or oven liner protective coating of any kind should be used in or around any part of the oven.
- **Do Not Clean Door Gasket**—The door gasket is essential for a good seal. Care should be taken not to rub, damage or move the gasket.

SAVE THESE INSTRUCTIONS

Grounding type wall receptacle

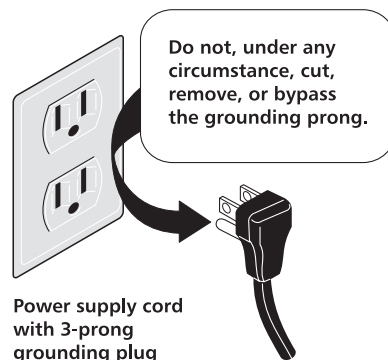

Control Pad Functions

READ THE INSTRUCTIONS CAREFULLY BEFORE USING THE OVEN.

For satisfactory use of your oven, become familiar with the various functions of the oven as described below. Your model will have one of the 2 controls shown. Refer to Figure 1 or Figure 2, depending on your model.

The oven can be programmed to:

- Bake normally
- Time bake (Figure 2 Only)
- Vari Broil
- Self-clean

Figure 1

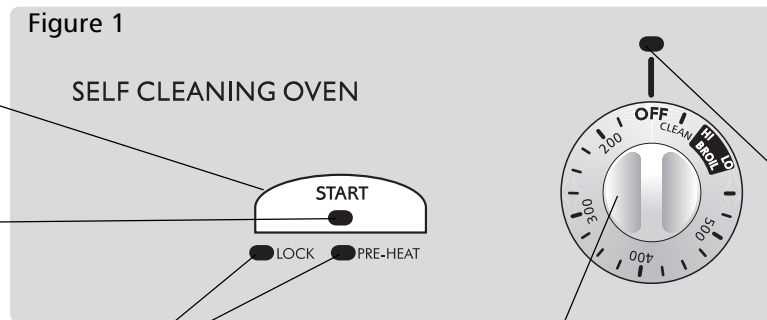

START PAD—Push to activate oven after oven functions are set.

START INDICATOR LIGHT—Flashes as a reminder to push the **START pad** to activate the oven.

PRE-HEAT & LOCK LIGHTS—The "PRE-HEAT" light will glow when the oven is first set to operate, or if the desired temperature is reset higher than the actual oven temperature. The "LOCK" light will flash until the door locks (or unlocks fully) when the self-clean cycle is in use. It glows constantly after the door locks.

TEMPERATURE CONTROL KNOB— Operates the Variable Broil, Bake or Self-Clean Cycle modes when used with the **START pad**. Cancels all oven functions when the Temperature Control knob is turned to **OFF**.

OVEN INDICATOR LIGHT—Glow each time the oven burner (element) turns on to maintain the set oven temperature.

PRE-HEAT & LOCK LIGHTS—The "PRE-HEAT" light will glow when the oven is first set to operate, or if the desired temperature is reset higher than the actual oven temperature. The "LOCK" light will flash until the door locks (or unlocks fully) when the self-clean cycle is in use. It glows constantly after the door locks.

CLOCK PAD— Used to set the time of day clock.

BAKE TIME PAD— Used to enter the length of the baking time.

FEATURE INDICATOR LIGHTS— These light to show which feature is in use.

STOP TIME PAD— Used to set the desired stop time for baking. Can be used with **BAKE TIME** to program a delayed bake cycle.

TIMER ON/OFF PAD— Used to set the minute timer. The minute timer does not start or stop cooking.

Figure 2

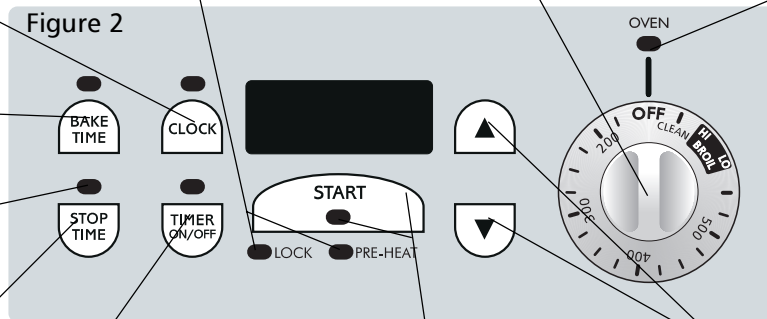

TEMPERATURE CONTROL KNOB— Operates the Variable Broil, Bake or Self-Clean Cycle modes when used with the **START pad**. Cancels all oven functions when the Temperature Control knob is turned to **OFF**.

OVEN INDICATOR LIGHT—Glow each time the oven burner (element) turns on to maintain the set oven temperature.

START PAD—Push to activate oven after oven functions are set.

START INDICATOR LIGHT—Flashes as a reminder to push the **START pad** to activate the oven.

UP and DOWN ARROW PADS— Used along with the function pads to select cooking time, stop time (when programming an automatic stop time), time of day and minute timer, and self-clean function.

Setting the Clock and Minute Timer

(if equipped)

For a silent control panel

(Figure 2 Only):

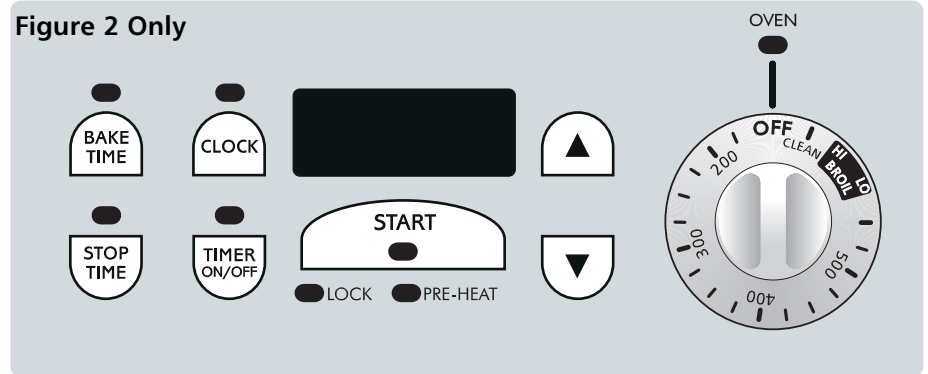

When choosing a function, a beep will be heard each time a pad is pushed. If desired, the controls can be programmed for silent operation. Push and hold **STOP TIME**. After 7 seconds, the control will beep once. This will block the controls from sounding when a pad is pushed. To return the sound, push and hold **STOP TIME** again for 7 seconds until 1 beep is heard. **Note:** The control will return to the audible mode after a power outage.

Figure 2 Only





To Set the Clock (Figure 2 Only)

When the range is first plugged in, or when the power supply to the range has been interrupted, the display will flash "12:00".

1. Push .
2. Within 5 seconds, push and hold  or  until the correct time of day appears in the display.

Note: The clock cannot be changed during any timed bake or self-clean cycle.

To Set the Minute Timer



1. Push .
2. Push  to increase the time in one minute increments. Push and hold  to increase the time in 10 minute increments. The timer can be set for any amount of time from 1 minute to 11 hours and 59 minutes.

Note: If you push  first, the timer will advance to 11 hours and 59 minutes.

3. The display shows the timer count down in minutes until one minute remains. Then the display will count down in seconds.
4. When the set time has run out, the timer will beep 3 times. It will then continue to beep 3 times every 60 seconds until  is pushed.

Note: The minute timer does not start or stop cooking. It serves as an extra timer in the kitchen that will beep when the set time has run out. The minute timer can be used alone or during any of the other oven functions. When the minute timer is in use with any other mode, the minute timer will be shown in the display. To view other functions, push the function pad for that mode.

To Change the Minute Timer while it is in use:

While the timer is active and shows in the display, push and hold  or  to increase or decrease the time.

To Cancel the Minute Timer before the set time has run out:

Push .

Flame Size

Never extend the flame beyond the outer edge of the utensil. A higher flame simply wastes heat and energy, and increases your risk of being burned by the flame.

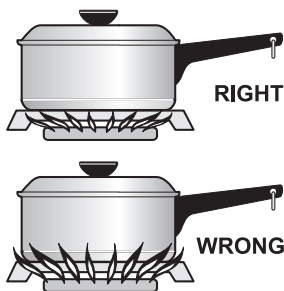

For most cooking, start on the highest control setting and then turn to a lower one to complete the process. Use the chart below as a guide for determining proper flame size for various types of cooking. The size and type of utensil used and the amount of food being cooked will influence the setting needed for cooking.

For deep fat frying, use a thermometer and adjust the surface control knob accordingly. If the fat is too cool, the food will absorb the fat and be greasy. If the fat is too hot, the food will brown so quickly that the center will be undercooked. Do not attempt to deep fat fry too much food at once as the food will neither brown nor cook properly.

*Flame Size	Type of Cooking
High Flame	Start most foods; bring water to a boil; pan broiling
Medium Flame	Maintain a slow boil; thicken sauces, gravies; steam
Low Flame	Keep foods cooking; poach; stew

***These settings are based on using medium-weight aluminum pans with lids. Settings may vary when using other types of pans.**

Proper Burner Adjustments

The color of the flame is the key to proper burner adjustment. A good flame is clear, blue and hardly visible in a well-lighted room. Each cone of flame should be steady and sharply defined. Adjust or clean burner if flame is yellow-orange. To clean burner, see instructions under **General Cleaning**.

Setting Surface Controls

The surface control knob shown below may not look identical to the surface control knobs on your range; it is only representational.

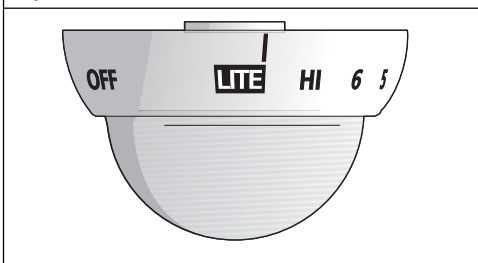

Your range is equipped with 4 standard burners, 2 standard and 2 large burners, or 3 standard and 1 large burner. Regardless of size, always select a utensil that is suitable for the amount and type of food being prepared. Select a burner and flame size appropriate to the pan. Never allow flames to extend beyond the outer edge of the pan.

For models equipped with the large burners, the larger burner is best used when bringing large quantities of liquid to temperature and when preparing larger quantities of food.

Each burner lights automatically from an electric ignitor each time a control knob is turned to the **LITE** position.

To operate the surface burner:

1. Place cooking utensil on burner.
2. **Push** the Surface Control knob **in** and **turn counterclockwise** out of the **OFF** position.
3. Release the knob and rotate to the **LITE** position. **Note:** All four electronic ignitors will click at the same time. However, only the burner you are turning on will ignite.
3. Visually check that the burner has lit.
4. **Push** the control knob **in** and **turn counterclockwise** to the desired flame size. The control knobs do not have to be set at a particular mark. Use the guides and adjust the flame as needed. **DO NOT** cook with the Surface Control knob in the **LITE** position. (The electronic ignitor will continue to click if left in the **LITE** position.)

In the event of an electrical power outage, the surface burners can be lit manually. To light a surface burner, hold a lit match to the burner head, then slowly turn the Surface Control knob to **LITE**. Use caution when lighting surface burners manually.

CAUTION Do not place plastic items such as salt and pepper shakers, spoon holders or plastic wrappings on top of the range when it is in use. These items could melt or ignite. Potholders, towels or wood spoons could catch fire if placed too close to a flame.

Setting Warmer Drawer Controls (if equipped)

Use the warmer drawer to keep hot foods hot such as: vegetables, gravies, meats, casseroles, biscuits and rolls, pastries and heated dinner plates.

The warmer drawer is equipped with a catch which may require extra force when opening and closing the drawer.

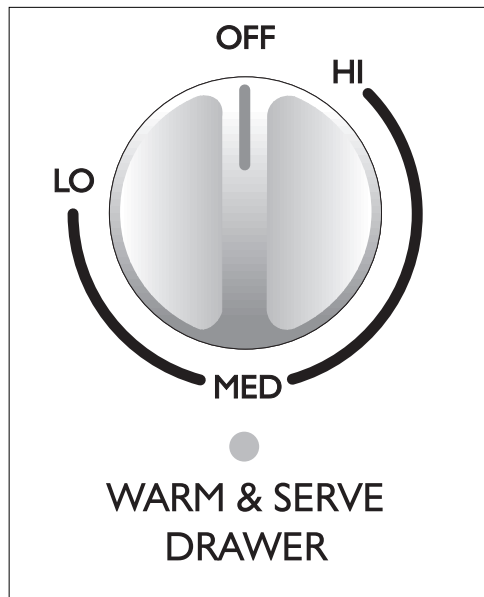

Arranging Warmer Drawer Rack Positions

The rack can be used in 2 ways:

- In the **upright position** to allow low profile food items to be placed both under and on top of the rack (for example, rolls or biscuits on top of the rack and a casserole dish under).
- In the **downward position** to allow you to place light weight food items and empty dishware (for example, rolls or pastries and dinner plates). Set the warmer drawer rack as shown below.

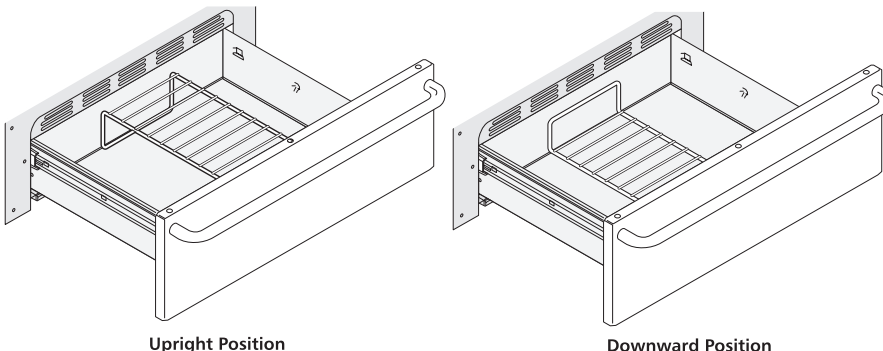

To Operate the Warmer Drawer

Your range is equipped with a warmer drawer. The purpose of the warmer drawer is to keep hot cooked foods at serving temperature. Always start with hot food. It is not recommended to heat cold food in the warmer drawer.

All food placed in the warmer drawer should be covered with a lid or aluminum foil to maintain quality. **Do not use plastic wrap to cover food. Plastic may melt onto the drawer and be very difficult to clean.**

Use only dishware, utensils and cookware recommended for oven use in the warmer drawer.

CAUTION Always use potholders or oven mitts when removing food from the warmer drawer as cookware and plates will be hot.

To Set the Thermostat Control

The thermostat control is used to select the temperature of the warmer drawer. It is located on the control panel. To set the thermostat, push in and turn the knob to the desired setting. The temperatures are approximate, and are designated by HI, MED and LO.

1. Turn the knob to select the desired temperature setting.
2. For best results, preheat the drawer before adding food. An empty drawer will preheat in approximately 15 minutes.
3. When done, turn the thermostat control to OFF.

Temperature Selection

Refer to the chart in the side column for recommended settings. If a particular food is not listed, start with the medium setting. If more crispness is desired, remove the lid or aluminum foil.

Most foods can be kept at serving temperatures by using the medium setting.

When a combination of foods are to be kept warm (for instance, a meat with 2 vegetables and rolls), use the high setting.

Refrain from opening the warmer drawer while in use to eliminate loss of heat from the drawer.

Indicator Light

The indicator light is located below the thermostat control. It turns on when the control is set, and stays on until the control is turned off. The warmer drawer is inoperable during the self-clean cycle. The indicator light will not come on during the self-clean cycle.

Warmer Drawer Recommended Food Settings Chart	
Food Item	Setting
Roasts (Beef, Pork, Lamb)	MED
Pork Chops	HI
Bacon	HI
Hamburger Patties	HI
Poultry	HI
Gravies	MED
Casseroles	MED
Eggs	MED
Fried Foods	HI
Vegetables	MED
Pizza	HI
Biscuits	MED
Rolls, soft	LO
Rolls, hard	MED
Pastries	MED
Empty Dinner Plates	LO

Before Setting Oven Controls

Arranging Oven Racks

(Some models may have one rack.) *ALWAYS ARRANGE OVEN RACKS WHEN THE OVEN IS COOL (PRIOR TO OPERATING THE OVEN).* Always use oven mitts when using the oven.

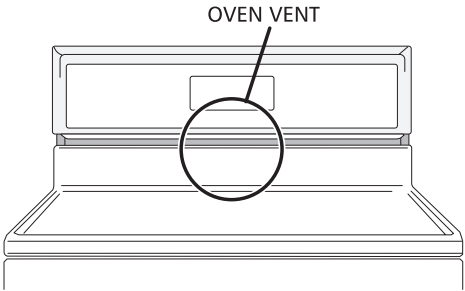
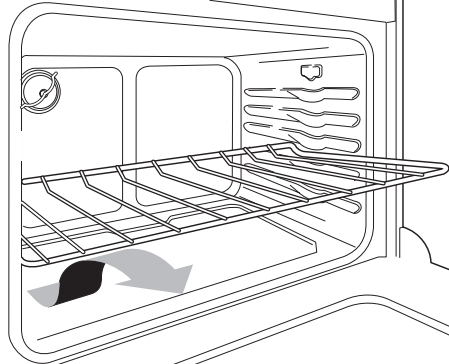
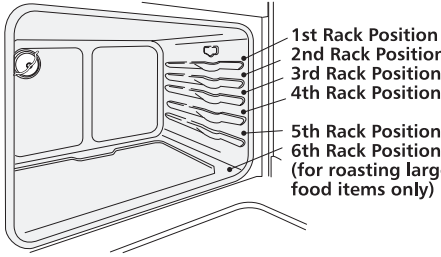
<p>Oven Vent Location The oven vent is located below the backguard. When the oven is on, warm air is released through the vents. This venting is necessary for proper air circulation in the oven and good baking results.</p>	<p>REMOVING & REPLACING OVEN RACKS To remove, pull the rack forward until it stops. Lift up front of rack and slide out. To replace, fit the rack onto the guides on the oven walls. Tilt the front of the rack upward and slide the rack back into place.</p>	<p>ARRANGING OVEN RACKS WITH 5 RACK POSITIONS To bake on 1 rack, place the rack on position 3 or 4. To bake on 2 racks, place the racks on positions 2 and 4.</p>
		

Setting Oven Controls

Figure 1

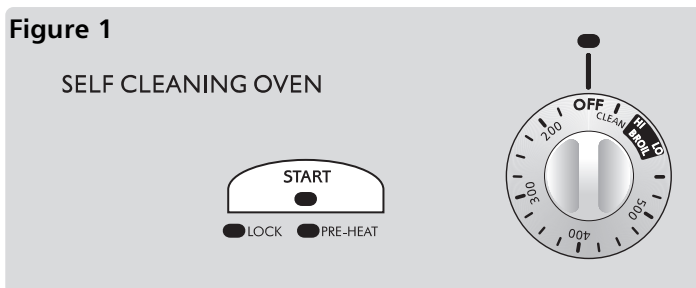
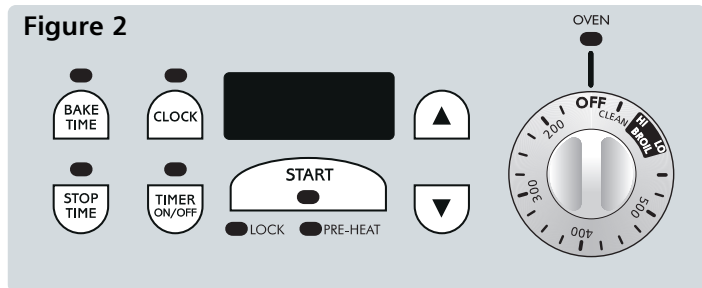

Figure 2





Note: The oven control has a built-in safety feature that will shut off the oven if the control is left on for more than 11 hours 59 minutes.

To Set or Change the Temperature for Normal Baking

The oven can be programmed to bake at any temperature from 170°F to 550°F (65°C to 287°C).

To Set the Controls for Normal Baking:

1. Turn Temperature Control Knob to the desired baking temperature.
2. Push . If  is not pushed, the control will beep as a reminder.
3. The oven will begin heating to the selected temperature. When the temperature reaches the desired baking temperature, the control will beep 3 times.
4. To cancel the baking function, turn Temperature Control Knob to **OFF**.

To Change the Oven Temperature after Baking has Started:

Turn Temperature Control Knob to the new, desired temperature.

If the Power is Interrupted During a Bake Cycle:

Figure 1—Press  to resume cooking.

Figure 2—Set clock to time of day, then press .

Setting Oven Controls

(continued)

Figure 2 Only

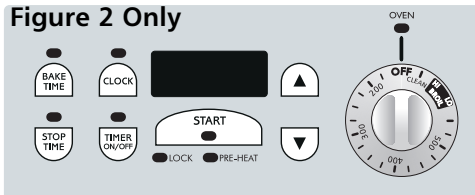

CAUTION Use caution when using the automatic timer. Use the automatic timer when cooking cured or frozen meats and most fruits and vegetables. Foods that can easily spoil such as milk, eggs, fish, meat or poultry, should be chilled in the refrigerator first. Even when chilled, they should not stand in the oven for more than 1 hour before cooking begins, and should be removed promptly when cooking is completed.

To Set the Automatic Timer (Timed Bake Feature, Figure 2 Only)

The **BAKE TIME** and **STOP TIME** controls operate the Timed Bake feature. The automatic timer will turn the oven on and off at the times you select in advance. The oven can be programmed to start immediately and shut off automatically or to begin baking at a later time with an automatic shutoff.

To Begin Baking Immediately with an Automatic Shut-Off:

1. Be sure that the clock shows the correct time of day.
2. Place the food in the oven.
3. Turn Temperature Control Knob to the desired baking temperature.
4. Push **BAKE TIME**. "0:00" will flash in the display.
5. Push **▲** or **▼** until the desired amount of baking time appears in the display.
6. Push **START**. If **START** is not pushed, the control will beep as a reminder.

For a Delayed Start Time and Automatic Shut-Off:

1. Be sure that the clock shows the correct time of day.
2. Place the food in the oven.
3. Turn Temperature Control Knob to the desired baking temperature.
4. Push **BAKE TIME**. "0:00" will flash in the display.
5. Push **▲** or **▼** until the desired amount of baking time appears in the display.
6. Push **STOP TIME**. The earliest possible stop time will flash in the display.
7. Push **▲** or **▼** until the desired stop time appears in the display.
8. Push **START**.
9. Once the controls are set, the control calculates the time when baking will start in order to finish at the time you have set.

Once the Controls are Set:

- a. The oven will come on and begin heating to the selected baking temperature.
- b. The current time of day will show in the display. To view remains of Bake Time, push **BAKE TIME**.

When the Set Bake Time Runs Out:

- a. "END" will appear in the display window and the oven will shut off automatically.
- b. The control will beep 3 times every 60 seconds until the Temperature Control Knob is turned to **OFF**.

To Change the Oven Temperature or Bake Time after Baking has Started: Turn Temperature Control Knob to the new, desired temperature.

To Change the Bake Time or Stop Time after Baking has Started:

Push **BAKE TIME** or **STOP TIME**. Then, push the **▲** or **▼**.

Setting Oven Controls

(continued)

Figure 1

SELF-CLEANING OVEN

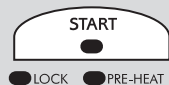
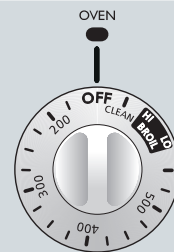
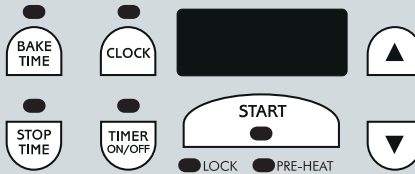
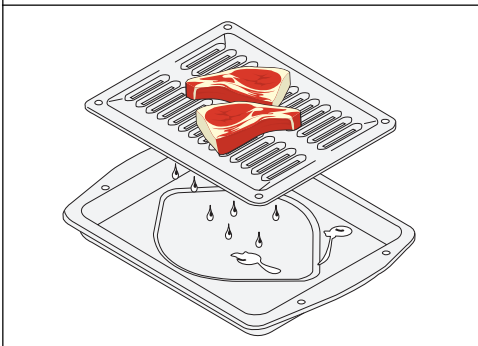

Figure 2



The broiler pan and its grid allow dripping grease to drain and be kept away from the high heat of the broiler. **DO NOT** use the pan without its grid. **DO NOT** cover the grid with foil. The exposed grease could ignite.



To Broil

1. Arrange oven rack while oven is still cool. Position the rack as suggested in the chart below.

Rack Position From Top	Food
1	Rare steaks
2	Ham slices, fish, medium steaks, hamburgers and chops
3	Well-done foods such as chicken and lobster

2. Place the grid on the broiler pan, then place the food on the grid. **DO NOT** use the broiler pan without the grid or cover the grid with aluminum foil. The exposed fat could ignite.
3. Place the pan on the oven rack. **Close the oven door when broiling.**
4. Turn Temperature Control Knob to the desired broil setting. The broiling temperature can be set at 2 different levels—High Broil (HI) or Low Broil (LO). Most foods can be broiled at the HI broil setting. Select the LO broil setting to avoid excess browning or drying of foods that should be cooked to the well-done stage.
5. Push  **START**.
6. Broil on one side until food is browned; turn and cook on the second side. Season and serve. **Note:** Always pull the rack out to the stop position before turning or removing food.
7. When broiling is finished, turn Temperature Control Knob to **OFF**.

CAUTION Should an oven fire occur, leave the oven door closed and turn off the oven. If the fire continues, use a fire extinguisher. **DO NOT** put water or flour on the fire. Flour may be explosive.

Oven Cleaning

Figure 1

SELF CLEANING OVEN

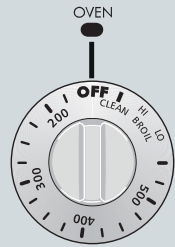
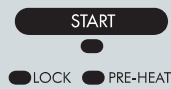
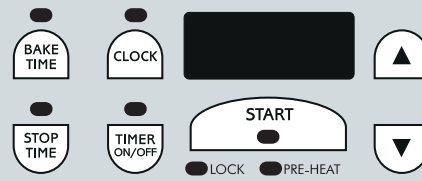

Figure 2



CAUTION During the self-cleaning cycle, the outside of the range can become very hot to the touch. **DO NOT** leave small children unattended near the appliance.

CAUTION **DO NOT** line the oven walls, racks, bottom or any other part of the range with aluminum foil. Doing so will destroy heat distribution, produce poor baking results and cause permanent damage to the oven interior (aluminum foil will melt to the interior surface of the oven).



CAUTION **DO NOT** force the oven door open. This can damage the automatic door locking system. Use caution when opening the door after the self-cleaning cycle is completed. The oven may still be **VERY HOT**.

Self-Cleaning Oven

A self-cleaning oven cleans itself with high temperatures (well above cooking temperatures) which eliminate soil completely or reduce it to a fine powdered ash you can wipe away with a damp cloth.

1. Adhere to the following cleaning precautions:

- Allow the oven to cool before precleaning.
- Wear rubber gloves when precleaning and while wiping up the residue after the self-clean cycle.
- **DO NOT** use oven cleaners or oven protective coatings in or around any part of the self-cleaning oven.
- **DO NOT** clean the oven door gasket. The woven material of the oven door gasket is essential for a good seal. Care should be taken not to rub, damage or remove the gasket.
- **DO NOT** use any cleaning materials on the oven door gasket. Doing so could cause damage.

2. Remove the broiler pan and insert, all utensils and any aluminum foil. These items cannot withstand high cleaning temperatures.

3. Oven racks may be left in the oven or may be removed. If they go through the clean cycle their color will turn slightly blue and the finish will be dull. After the cycle is complete and the oven has cooled, rub the sides of the racks with wax paper or a cloth containing a small amount of baby oil or salad oil (this will make the racks glide easier into the rack position).

4. Remove any excess spillovers in the oven cavity before starting the self-cleaning cycle. To clean, use hot, soapy water and a cloth. Large spillovers can cause heavy smoke or fire when subjected to high temperatures. **DO NOT** allow food spills with a high sugar or acid content (such as milk, tomatoes, sauerkraut, fruit juices or pie filling) to remain on the surface as they may cause a dull spot even after cleaning.

5. Clean any soil from the oven frame, the door liner outside the oven door gasket and the small area at the front center of the oven bottom. These areas heat sufficiently to burn soil on. Clean with soap and water.

Oven Cleaning

(continued)

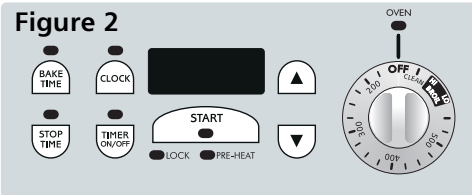

To Start the Self-Clean Cycle (Figure 1)

The oven is programmed to run a 3 hour self-clean cycle.

1. Be sure the oven door is closed.
2. Turn Temperature Control Knob to **CLEAN**.
3. Push .
4. If the door is left open, the "LOCK" indicator light will flash, but the lock motor and clean cycle will not start. As soon as the controls are set and the door is closed, the motor driven lock will begin to close automatically and the "LOCK" indicator light will flash. **DO NOT** open the door while the light is flashing (it takes about 15 seconds for the lock to close).



When the Self-Clean Cycle is Completed (Figure 1)

1. The "LOCK" indicator light will continue to glow.
2. Once the oven has cooled down for about 1 HOUR and the "LOCK" indicator light has gone completely out (and is not flashing), the oven door can be opened.

To Start the Self-Clean Cycle (Figure 2)

The oven can be programmed to run a 2 or 3 hour self-clean cycle. We recommend a 2 hour self-clean cycle for **light soils** and a 3 hour cycle for **average to heavy soils** (to assure satisfactory results).

To Set the Controls:

1. Be sure the oven door is closed.
2. Turn Temperature Control Knob to **CLEAN**.
3. Push . "3:00" will appear in the display. (The oven will automatically program a 3 hour clean cycle.)
4. If you want a 2 hour clean cycle, press . "2:00" will appear in the display.
5. If the door is left open, the "LOCK" indicator light will flash and "dr" will glow in the display, but the lock motor and clean cycle will not start. As soon as the controls are set and the door is closed, the motor driven lock will begin to close automatically and the "LOCK" indicator light will flash. "CLn" will appear and remain in the display until the cleaning cycle is completed or cancelled. **DO NOT** open the door while the light is flashing (it takes about 15 seconds for the lock to close).
6. Press  at any time during the self-clean cycle to review remaining cleaning time.

When the Self-Clean Cycle is Completed (Figure 2)

1. The time of day will appear in the display window and the "LOCK" indicator light will continue to glow.
2. Once the oven has cooled down for about 1 HOUR and the "LOCK" indicator light has gone completely out (and is not flashing), the oven door can be opened.

Stopping or Interrupting a Self-Cleaning Cycle (Figure 1 or 2)

If it becomes necessary to stop or interrupt a self-cleaning cycle due to excessive smoke or fire:

1. Turn Temperature Control Knob to **OFF**.
2. Once the oven has cooled down for about 1 HOUR and the "LOCK" indicator light has gone completely out (and is not flashing), the oven door can be opened.
3. Correct the condition which caused the smoking.
4. Restart the self-cleaning cycle once all conditions have been corrected.

Note: If the oven is set to bake or broil, and then the Temperature Control Knob is set to **CLEAN**, it will not start the clean cycle until **START** is pressed again.



CAUTION Use care when opening the oven door after the self-cleaning cycle. Stand to the side of the oven when opening the door to allow hot air or steam to escape.

CAUTION **DO NOT** force the oven door open. This can damage the automatic door locking system. Use caution when opening the door after the self-cleaning cycle is completed. The oven may still be **VERY HOT**.

General Cleaning

Cleaning Various Parts of Your Range

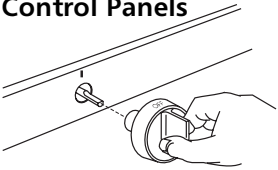
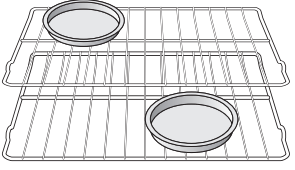
Before cleaning any part of the range, be sure all controls are turned OFF and the range is cool. Remove spillovers and heavy soiling as soon as possible. Regular cleanings will reduce the effort required for major cleanings later.

Surfaces	How to Clean
Aluminum (Trim Pieces) & Vinyl	Use hot, soapy water and a cloth. Dry with a clean cloth.
Glass, Painted and Plastic Body Parts, Control Knobs and Decorative Trim Pieces	<i>For general cleaning</i> , use hot, soapy water and a cloth. <i>For more difficult soils and built-up grease</i> , apply a liquid detergent directly onto the soil. Leave on soil for 30 to 60 minutes. Rinse with a damp cloth and dry. DO NOT use abrasive cleaners on any of these materials; they can scratch.
Control Panels 	<i>Before cleaning the control panel</i> , turn all controls to OFF and remove the control knobs. To remove, pull each knob straight off the shaft. Clean as instructed above. Squeeze excess water from the cloth before wiping the panel; especially when wiping around the controls. Excess water in or around the controls may cause damage to the appliance. To replace knobs after cleaning, line up the flat sides of both the knob and the shaft, then push the knob(s) into place.
Porcelain Enamel Burner Grates, Cooktop Surface, Below Cooktop, Warmer Drawer, Door Liner and Oven Bottom	Clean burner grates, broiler pan and insert in the dishwasher and dry upon removal. If soils are not removed, follow the cooktop cleaning instructions below. Gentle scouring with a soapy scouring pad will remove most spots. Rinse with a 1:1 solution of clean water and ammonia. <i>If necessary</i> , cover difficult spots with an ammonia-soaked paper towel for 30 to 40 minutes. Rinse with clean water and a damp cloth, then scrub with a soap-filled scouring pad. Rinse and wipe dry with a clean cloth. Remove all cleaners or the porcelain may become damaged during future heating. DO NOT use spray oven cleaners on the range top.
Stainless Steel, Chrome Parts, Drip Pans	Clean with hot, soapy water and a dishcloth. Rinse with clean water and a cloth. Cover stubborn spots with an ammonia-soaked paper towel for 30-40 minutes. Rinse. Cleaners made especially for stainless steel are recommended. Be sure to rinse the cleaners as bluish stains may occur during heating and cannot be removed.
Oven Racks 	Remove racks. See "Removing and Replacing Oven Racks" under Before Setting Oven Controls . Use a mild, abrasive cleaner, following manufacturer's instructions. Rinse with clean water and dry. After cleaning the racks, rub the sides of the racks with wax paper or a cloth containing a small amount of baby oil or salad oil (this will make the racks glide easier into the rack positions). The holes in the burners of your range must be kept clean at all times for proper ignition and a complete, even flame. Clean the burner holes routinely with a small gauge wire or needle and especially after bad spillovers which could clog these holes.
Surface Burners - Sealed Burner Units - Burner Cap, Trim Ring (some models), Burner Pans (some models), and Burner Base	The holes in the burners of your range must be kept clean at all times for proper ignition and a complete, even flame. Clean the burner holes routinely with a small gauge wire or needle and especially after bad spillovers which could clog these holes. To remove, clean and replace sealed burner units, follow the instructions under General Cleaning . DO NOT put burner units in the dishwasher.
Oven Door 	To clean oven door, wash with hot, soapy water and a clean cloth. DO NOT immerse the door in water. DO NOT clean the oven door gasket. The woven material of the oven door gasket is essential for a good seal. Care should be taken not to rub, damage or remove the gasket.

General Cleaning

(continued)

Unlike the standard gas range, THIS COOKTOP IS NOT REMOVABLE. Do not attempt to remove or lift the cooktop.

Note: The burner cap assembly refers to all parts of the sealed burner unit (burner cap, burner pan (some models), trim ring (some models), locating tab, burner base and electrode).

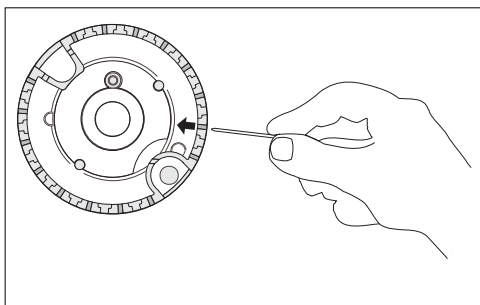
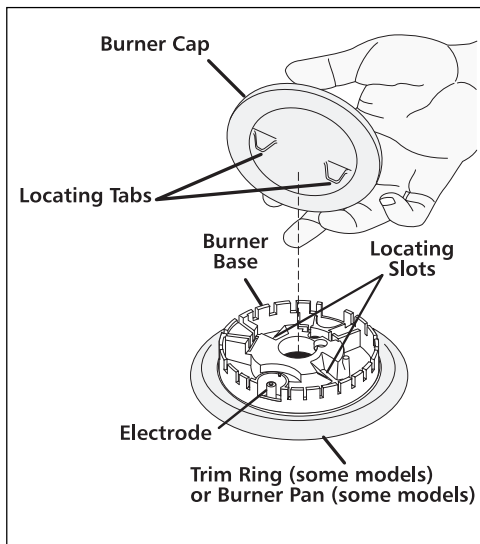

CAUTION Use caution when replacing the burner cap so the electrode is not damaged. This may cause a delayed ignition or prevent the burner from igniting.

CAUTION Any additions, changes or conversions required in order for this appliance to satisfactorily meet the application needs must be made by an authorized **Frigidaire** Distributor or Qualified Agency.

To Clean the Cooktop

The cooktop is designed to make cleaning easier. Because the four burners are sealed, cleanups are easy when spillovers are cleaned up immediately.

To clean, wipe with a clean, damp cloth and wipe dry.

To Clean the Contoured Well Areas, Burner Cap Assembly, Trim Ring (some models), Burner Pan (some models) and Burner Base

The contoured well areas, burner cap assembly, trim ring (some models), burner pan (some models) and burner base should be routinely cleaned. Keeping the burner ports clean will prevent improper ignition and an uneven flame. See instructions below.

To Clean the Contoured Well Areas

The contoured well is a recessed area located around each burner unit. If a spill occurs in one of the four well areas, blot up spill with an absorbent cloth. Rinse with a clean, damp cloth and wipe dry.

To Remove the Burner Cap Assembly

The burner cap assembly parts differ per model. Your assembly will consist of one of the following combinations: burner cap and trim ring; burner cap and burner pan; or burner cap, trim ring and burner pan. Remove in the following order: (1st) burner cap, (2nd) trim ring and (3rd) burner pan. **Do not operate the burners without the burner cap assembly in place.**

To Clean the Burner Cap, Burner Pan (some models) and Trim Ring (some models)

Use a soap-filled scouring pad or a mild abrasive cleanser to clean burner caps, trim rings and burner pans.

To Clean the Burner Base and Gas Opening

The ports (or slots) around the burner base must be routinely cleaned. Use a small-gauge wire or needle to clean small slots or holes. Use care to prevent damage to the electrode. If a cleaning cloth should catch the electrode, it could break or damage the electrode. If the electrode is damaged or broken, the surface burner will not light.

For proper flow of gas and ignition of the burner—**DO NOT ALLOW SPILLS, FOOD, CLEANING AGENTS OR ANY OTHER MATERIAL TO ENTER THE GAS OPENING.** Gas must flow freely through the small hole in the brass orifice for the burners to light properly. If the orifice gas opening becomes soiled or clogged, use a small-gauge wire or needle to clean. **ALWAYS** keep the burner cap assembly in place whenever a surface burner is in use.

To Replace the Burner Cap Assembly

Make sure the burner cap assembly is thoroughly dry before placing back on the burner.

1. Lower burner pan (some models) into place around the burner base.
2. Replace trim ring (some models).
3. Find the locating tabs on the burner cap and place in the locating slots in the burner base. Make sure each burner cap is properly aligned and level.
4. Turn the burner on to determine if it will light. If the burner does not light after cleaning, contact an authorized servicer. Do not service the sealed burner yourself.

General Cleaning

(continued)

⚠ CAUTION The door is heavy. For safe, temporary storage, lay the door flat with the inside of the door facing down.

To Remove and Replace Oven Door

To Remove Oven Door:

1. Open the door.
2. Remove screws located on the inside of the oven door near the hinges **A** (one on each side.)
3. Close the door to the quarter-open position. Grasp the door firmly on both sides and lift up and off the hinges.
4. To clean oven door, follow the instructions provided in the cleaning chart under **General Cleaning**

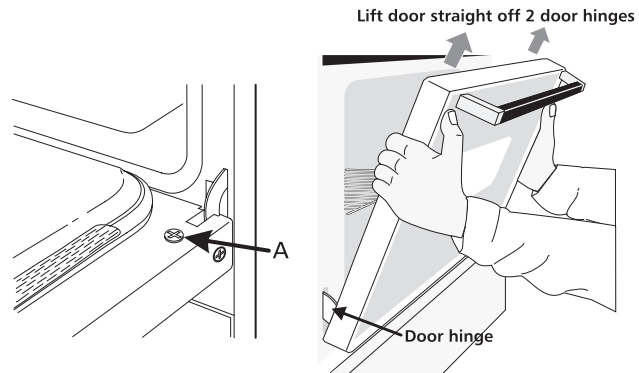

To Replace Oven Door:

1. Be sure the hinge arms are in the quarter-open position. Be careful if pulling the hinges open by hand. The hinges may snap back against the oven frame and could pinch fingers.
2. Hold the door at the sides near the top. Insert the hinge arms into slots at the bottom of the door.
3. Hinge arms must go into the range slots evenly. The hinge arms should be inserted into the bottom corners of the door as far as they can go.
4. If the door is not in line with the oven frame, remove it and repeat the above steps.

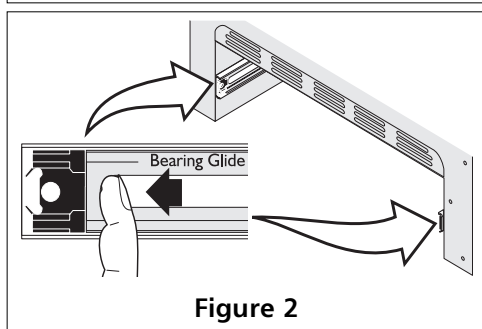
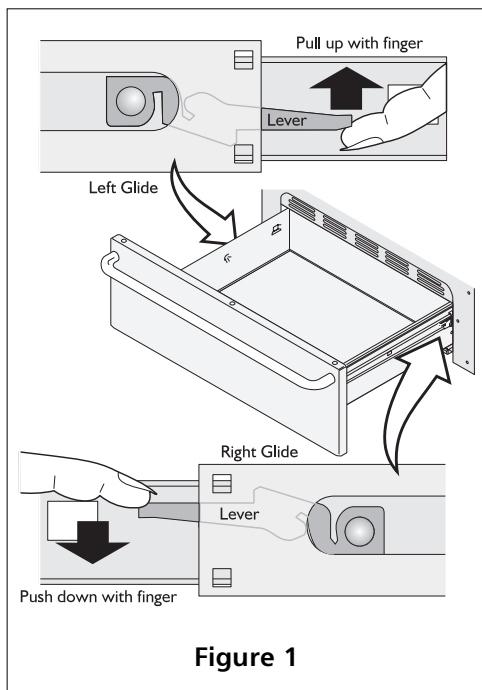

To Remove and Replace Warmer Drawer (if equipped)

To Remove Warmer Drawer:

1. **⚠ CAUTION** Turn power off before removing the warmer drawer.
2. Open the drawer to the fully opened position.
3. Locate glide lever on each side of drawer, pull up on the left glide lever and push down on the right glide lever (see figure 1).
5. Pull the drawer away from the range.

To Replace Warmer Drawer:

1. Pull the bearing glides to the front of the chassis glide (see figure 2).
2. Align the glide on each side of the drawer with the glide slots on the range.
3. Push the drawer into the range until levers "click" (approximately 2"). Pull the drawer open again to seat bearing glides into position. **If you do not hear the levers "click" or the bearing glides do not feel seated remove the drawer and repeat steps 1 thru 3.** This will minimize possible damage to the bearing glides.



⚠ WARNING Electrical Shock Hazard can occur and result in serious injury or death. Disconnect appliance from electric power before cleaning and servicing the warmer drawer.

Changing Oven Light (some models)

CAUTION Be sure the range is unplugged and all parts are COOL before replacing the oven light. Wear a leather-faced glove for protection against possible broken glass.

To Change the Oven Light (some models)

On some models, the oven light automatically turns on when the door is opened. Some models have a switch located on the control panel to turn on the light. The oven light is located at the rear of the oven and is covered with a glass shield held by a wire holder. The glass shield must be in place whenever the oven is in use.



To replace the oven light:

1. Turn electrical power off at the main source or unplug the range.
2. Press wire holder to one side to release the glass shield.
3. Replace bulb with a new 40 watt appliance bulb.
4. Replace glass shield over bulb and snap wire holder into place.
5. Turn power back on again at the main source (or plug the range back in).
6. The clock(if equipped) will then need to be reset. To reset, see **Setting the Clock and Minute Timer** in this Owner's Guide.

Adjusting Oven Temperature

Note: The adjustments made will not change the self-cleaning temperature.

Figure 1
SELF-CLEANING OVEN

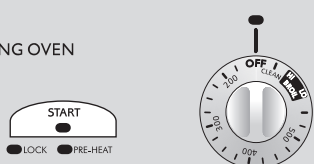

The temperature in the oven has been set at the factory. When first using the oven, be sure to follow recipe times and temperatures. If you think the oven is too hot or too cool, the temperature in the oven can be adjusted. Before adjusting, test a recipe by using a temperature setting that is higher or lower than the recommended temperature. The baking results should help you to decide how much of an adjustment is needed.

To Adjust Oven Temperature (Figure 1)

1. With the dial set to OFF, press and hold  for 30 seconds until a single beep is heard.
2. Within 5 seconds, turn the Temperature Control Knob **clockwise** to either the High (HI) or Low (LO) Broil setting. Select High Broil (HI) to increase the temperature or Low Broil (LO) to decrease the temperature.
3. The temperature can be adjusted up or down 35°F, in 5°F steps, by pressing **START**. Adjust until the desired amount of offset is indicated by the indicator lights as follows:



A flashing "OVEN" indicator light indicates a positive offset, while a flashing "LOCK" indicator light indicates a negative offset. The lights will flash once for each 5°F of offset. If no light is flashing, the oven control has the original factory calibration, and the offset is 0°F. *Example: If the OVEN indicator light is flashing three times and then pauses, the offset is +15°F.*

4. When you have made the desired adjustment, turn the Temperature Control Knob to OFF.

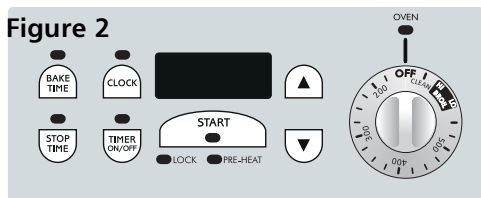
Figure 2



To Adjust Oven Temperature (Figure 2)

1. With the dial set to OFF, press and hold  for 30 seconds until a single beep is heard.
2. Within 5 seconds, turn the Temperature Control Knob **clockwise** to either the High Broil (HI) or Low Broil (LO) setting.
3. The display now indicates the amount of degrees offset between the original factory temperature setting and the current temperature setting. If the oven control has the original factory calibration, the display will read "00."
4. The temperature can now be adjusted up or down 35°F, in 5°F steps, by pushing and holding  or . Adjust until the desired amount of offset appears in the display.
5. When you have made the desired adjustment, turn the Temperature Control Knob to OFF.

Avoid Service Checklist

Before you call for service, review this list. It may save you time and expense. The list includes common occurrences that are not the result of defective workmanship or materials in this appliance.

This oven is equipped with a state of the art electronic oven controller. Among its many features is a full time oven circuit diagnostics system. The controller constantly monitors its internal circuitry as well as several crucial oven circuits to insure they are all operating correctly. If at any time one of these systems fails, the controller will immediately stop operation, and beep continuously (flashing an error code of F1 or F3* in the display window, if equipped).

OCCURRENCE

POSSIBLE CAUSE/SOLUTION

Range is not level.

Poor installation. Place oven rack in center of oven. Place a level on the oven rack. Adjust leveling legs at base of range until the rack is level. When range is level, cooktop may appear out of alignment if countertop is not level.

Weak, unstable floor. Be sure floor is level and can adequately support range. Contact a carpenter to correct sagging or sloping floor.

Kitchen cabinet misalignment may make range appear to be unlevel. Be sure cabinets are square and have sufficient room for range clearance.

Cannot move appliance easily. Appliance must be accessible for service.

Cabinets not square or are built in too tight. Contact a cabinet maker to correct the problem.

Contact builder or installer to make appliance accessible.

Carpeting interferes with range. Provide sufficient space so range can be lifted over carpet.

Gas line is hard-plumbed. Have a flexible A.G.A./C.G.A. approved metal appliance connector installed.

*Oven control beeps continuously with no indicator lights flashing. (If model is equipped with a display, F1 or F3 will show.)

Electronic control has detected a fault condition. Turn the Temperature Control Knob to OFF, and disconnect the power to the range. Wait 30 seconds and reconnect the power. If fault recurs, disconnect the power and contact an authorized servicer.

Surface burners do not light.

Surface Control knob has not been completely turned to LITE. Push in and turn the Surface Control knob to LITE until burner ignites and then turn control knob to desired flame size.

Burner ports are clogged. Clean burners. See "To Clean the Contoured Well Areas, Burner Cap Assembly, Trim Ring (some models), Burner Pan (some models) and Burner Base" under **General Cleaning**. With the burner off, clean ports with a small-gauge wire or needle.

Range power cord is disconnected from outlet (Electric Ignition Models only). Be sure cord is securely plugged into the outlet.

Electrical power outage (electric ignition models only). Burners can be lit manually. See **Setting Surface Controls** in this Owner's Guide.

Surface burner flame burns half way around.

Burner ports are clogged. With the burner off, clean ports by using a small-gauge wire or needle.

Moisture is present after cleaning. Lightly fan the flame and allow burner to operate until flame is full. Dry the burners thoroughly following instructions in the **General Cleaning** section.

Surface burner flame is orange.

Dust particles in main line. Allow the burner to operate a few minutes until flame turns blue.

In coastal areas, a slightly orange flame is unavoidable due to salt air.

Oven does not operate.	<p>Be sure the electronic oven controls are set correctly for the desired function. See Setting Oven Controls in this Owner's Guide or Entire Appliance Does Not Operate (see below).</p> <p>Be sure regulator gas valve is "ON". See installation instructions.</p>
Entire appliance does not operate.	<p>Make sure electrical cord/plug is plugged tightly into outlet (electric ignition models only).</p> <p>Service wiring not complete. Contact servicer or dealer.</p> <p>Electrical power outage (electric ignition models only). Check house lights to be sure. Call your local electric company for service. Surface burners can be lit manually. See Setting Surface Controls in this Owner's Guide.</p> <p>Be sure gas supply is turned on.</p>
Cooktop and/or oven light (some models) does not work.	<p>Burned-out or loose bulb. See Changing Cooktop and/or Oven Lights (some models) section in this Owner's Guide to replace or tighten the bulb.</p>
Oven smokes excessively during broiling.	<p>Oven door is open. Door should be closed during broiling.</p> <p>Meat too close to broil burner. Reposition the rack to provide more clearance between the meat and the broiler.</p> <p>Meat not properly prepared. Remove excess fat from meat. Slash remaining fatty edges to prevent curling, but do not cut into the lean.</p> <p>Broiler pan used without grid or grid covered with foil. DO NOT use the broiler pan without grid or cover grid with foil.</p> <p>Oven needs to be cleaned. Grease has built up on oven surfaces. Regular cleaning is necessary when broiling frequently. Old grease or food spatters cause excessive smoking.</p>
Poor baking results.	<p>Many factors affect baking results. Make sure the proper rack position is used. Center food in the oven and space pans to allow air to circulate. Allow the oven to preheat to the set temperature before placing food in the oven. Try adjusting the recipe's recommended temperature or baking time. If you feel the oven is too hot or cool, see Adjusting Oven Temperature in this Owner's Guide.</p>
Self-Cleaning cycle does not work.	<p>Controls are not set properly. Follow instructions under Oven Cleaning.</p> <p>Self-cleaning cycle was interrupted. Stop time must be set 2 to 4 hours past the start time. Follow steps under "Stopping or Interrupting a Self-Clean Cycle" under Oven Cleaning.</p>
Soil is not completely removed.	<p>Failure to clean bottom front, top of oven or door areas outside oven seal. These areas are not in the self-cleaning area, but get hot enough to burn on residue. Clean these areas before starting the self-clean cycle. Burned-on residue may be cleaned with a stiff nylon brush and water or a nylon scrubber. Be careful not to damage the oven gasket.</p> <p>Excessive spillovers in oven. Set self-clean cycle for a longer cleaning time.</p>
Flames inside oven or smoking from vent.	<p>Excessive spillovers in oven. This is normal, especially for pie spillovers or large amounts of grease on the oven bottom. Wipe up excessive spillovers before starting the self-clean cycle. If flames or excessive smoke are present, stop the self-clean cycle and follow the steps under "Stopping or Interrupting the Self-Clean Cycle" in the Oven Cleaning section.</p>

FRIGIDAIRE RANGE WARRANTY

Your Frigidaire product is protected by this warranty

	WARRANTY PERIOD	FRIGIDAIRE, THROUGH ITS AUTHORIZED SERVICERS, WILL:	THE CONSUMER WILL BE RESPONSIBLE FOR:
FULL ONE-YEAR WARRANTY	One year from original purchase date.	Pay all costs for repairing or replacing any parts of this appliance which prove to be defective in materials or workmanship.	Costs of service calls that are listed under NORMAL RESPONSIBILITIES OF THE CONSUMER.*
LIMITED WARRANTY (Applicable to the State of Alaska)	Time period listed above.	All of the provisions of the full warranty above and the exclusions listed below apply.	Costs of the technician's travel to the home and any costs for pick up and delivery of the appliance required because of service.

Your appliance is warranted by Frigidaire Home Products, a division of White Consolidated Industries, Inc. We authorize no person to change or add to any of our obligations under this warranty. Our obligations for service and parts under this warranty must be performed by Frigidaire Home Products Consumer Services or an authorized Frigidaire servicer.

*NORMAL RESPONSIBILITIES OF THE CONSUMER

This warranty applies only to products in ordinary household use, and the consumer is responsible for the items listed below:

1. Proper use of the appliance in accordance with instructions provided with the product.
2. Proper installation by an authorized servicer in accordance with instructions provided with the appliance and in accordance with all local plumbing, electrical and/or gas codes.
3. Proper connection to a grounded power supply of sufficient voltage, replacement of blown fuses, repair of loose connections or defects in house wiring.
4. Expenses for making the appliance accessible for servicing, such as removal of trim, cupboards, shelves, etc., which are not a part of the appliance when it was shipped from the factory.
5. Damages to finish after installation.
6. Replacement of light bulbs and/or fluorescent tubes (on models with these features).

EXCLUSIONS

This warranty does not cover the following:

1. CONSEQUENTIAL OR INCIDENTAL DAMAGES SUCH AS PROPERTY DAMAGE AND INCIDENTAL EXPENSES RESULTING FROM ANY BREACH OF THIS WRITTEN OR ANY IMPLIED WARRANTY.
Note: Some states do not allow the exclusion or limitation of incidental or consequential damages, so this limitation or exclusion may not apply to you.
2. Service calls which do not involve malfunction or defects in workmanship or material, or for appliances not in ordinary household use. The consumer shall pay for such service calls.
3. Damages caused by services performed by persons other than authorized Frigidaire servicers; use of parts other than Frigidaire Home Products Genuine Renewal Parts; obtained from persons other than such servicers; or external causes such as abuse, misuse, inadequate power supply or acts of God.
4. Products with original serial numbers that have been removed or altered and cannot be readily determined.

IF YOU NEED SERVICE

Keep your bill of sale, delivery slip, or some other appropriate payment record. The date on the bill establishes the warranty period should service be required. If service is performed, it is in your best interest to obtain and keep all receipts. This written warranty gives you specific legal rights. You may also have other rights that vary from state to state. Service under this warranty must be obtained by following these steps, in order:

1. Contact Frigidaire Home Products Consumer Services or an authorized Frigidaire servicer.
2. If there is a question as to where to obtain service, call or write our Consumer Relations Department at:

Frigidaire Home Products Consumer Relations
P.O. Box 212378
Augusta, Georgia 30917-2378
(800) 944-9044



Product features or specifications as described or illustrated are subject to change without notice. All warranties are made by White Consolidated Industries, Inc. This warranty applies only in the 50 states of the U.S.A. and Puerto Rico.